



**Model Number**

**ML4.2-P-8m-RT/40b/76a/95/110**

Thru-beam sensor  
with 4-pin, M8 x 1 connector

**Features**

- Short response time
- Highly visible LEDs for Power-On, switching status, short-circuit, and undervoltage
- Test input
- Metal-reinforced fastening holes
- Optical surface made of scratch-resistant glass
- Push-pull output

**Product information**

The ML4.2 series is characterized by a robust, powerful and standard design in a miniature housing. The housing offers IP67/ IP69K degree of protection, a scratch- and chemical-resistant lens, highly visible LEDs and robust all-metal bushings for mounting. Adjustable and tamper-proof sensors are available with a universal push-pull output and an electrical light ON/dark ON switch. The sensors have a high ambient light limit. Reflections from the background are suppressed. The unusually small, sharp light spot and the quick response time offer maximum switching precision on object edges.. Both red and infrared light sources are available. A high-performance fixed focus background suppressor is a useful feature. The sensors are suitable for precise object detection and open up a wide range of application fields.

Release date: 2014-05-12 09:43 Date of issue: 2014-05-12 245917\_eng.xml

**Dimensions**

Transmitter

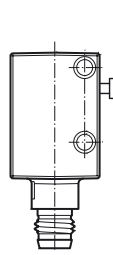

Receiver

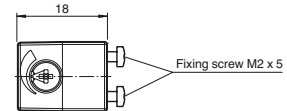
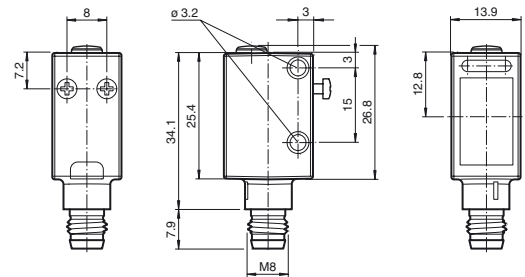

Optical axis

**Electrical connection**

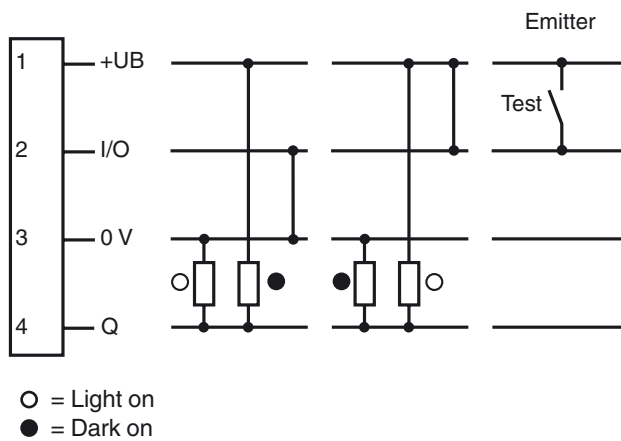

**Pinout**



**Indicators/operating means**

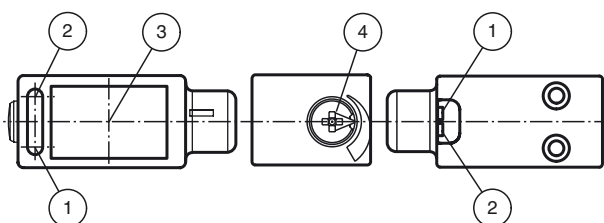

1	Operating display	green
2	Signal display (only Receiver)	yellow
3	Optical axis	
4	Sensitivity adjustment (only Receiver)	

**Technical data****System components**

Emitter	ML4.2-T-8m-RT/76a/95
Receiver	ML4.2-R/40b/95/110

**General specifications**

Effective detection range	0 ... 8000 mm
Threshold detection range	10000 mm
Light source	LED
Light type	modulated visible red light
Target size	min. 7 mm
Diameter of the light spot	300 mm at 8000 mm detection range
Angle of divergence	approx. 2 °
Ambient light limit	
Continuous light	40000 Lux
Modulated light	5000 Lux

**Functional safety related parameters**

MTTF <sub>d</sub>	550 a
Mission Time (T <sub>M</sub> )	20 a
Diagnostic Coverage (DC)	60 %

**Indicators/operating means**

Operation indicator	LED green, statically lit Power on , Undervoltage indicator: Green LED, pulsing (approx. 0.8 Hz) , short-circuit : LED green flashing (approx. 4 Hz)
Function indicator	LED yellow, lights up with receiver lit flashes when falling short of the stability control
Control elements	sensitivity adjustment

**Electrical specifications**

Operating voltage	U <sub>B</sub>	10 ... 30 V DC
Ripple		< 10 %
No-load supply current	I <sub>0</sub>	< 15 mA at 24 V DC

**Input**

Test input	emitter deactivation at +U <sub>B</sub>
------------	---

**Output**

Switching type	light/dark on electrically switchable	
Signal output	Push-pull output, short-circuit protected, reverse polarity protected	
Switching voltage	max. 30 V DC	
Switching current	max. 100 mA	
Voltage drop	U <sub>d</sub>	≤ 2.5 V DC
Switching frequency	f	2000 Hz
Response time		250 μs

**Ambient conditions**

Ambient temperature	-20 ... 60 °C (-4 ... 140 °F)
Storage temperature	-20 ... 75 °C (-4 ... 167 °F)

**Mechanical specifications**

Degree of protection	IP67 / IP69K
Connection	M8 x 1 connector, 4-pin
Material	
Housing	ABS
Optical face	glass pane
Mass	15 g (device)

**Compliance with standards and directives**

Standard conformity	
Product standard	EN 60947-5-2:2007 IEC 60947-5-2:2007
Shock and impact resistance	IEC / EN 60068. half-sine, 40 g in each X, Y and Z directions
Vibration resistance	IEC / EN 60068-2-6. Sinus. 10 -2000 Hz, 10 g in each X, Y and Z directions

**Approvals and certificates**

CE conformity	yes
UL approval	cULus Listed
CCC approval	CCC approval / marking not required for products rated ≤36 V

**Accessories****OMH-4.1**

Mounting Clamp

**OMH-ML6**

Mounting bracket

**OMH-ML6-U**

Mounting bracket

**OMH-ML6-Z**

Mounting bracket

**OMH-11-02 Aperture-V-H 0.5 mm**

Slit diaphragm can be affixed for detecting very small parts

**OMH-11-04 Aperture-V-H 1.0 mm**

Slit diaphragm can be affixed for detecting very small parts

**OMH-11-06 Aperture-V-H 1.5 mm**

Slit diaphragm can be affixed for detecting very small parts

**OMH-11-08 Aperture-V-H 2.0 mm**

Slit diaphragm can be affixed for detecting very small parts

**V31-GM-2M-PVC**

Female cordset, M8, 4-pin, PVC cable

**V31-WM-2M-PVC**

Female cordset, M8, 4-pin, PVC cable

Other suitable accessories can be found at [www.pepperl-fuchs.com](http://www.pepperl-fuchs.com)

Curves/Diagrams

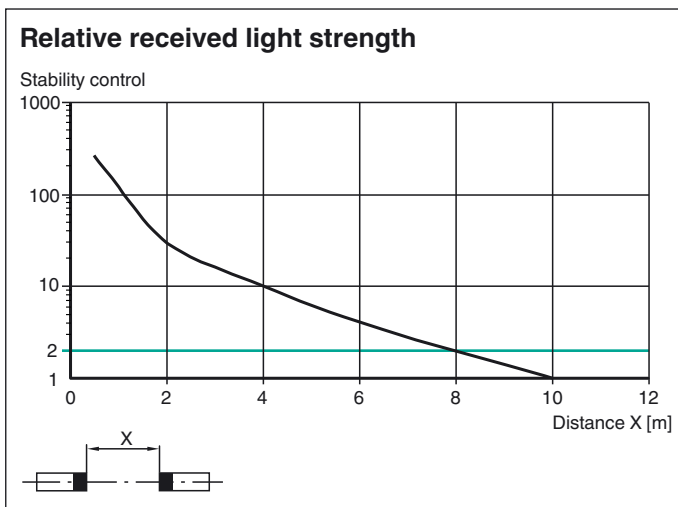
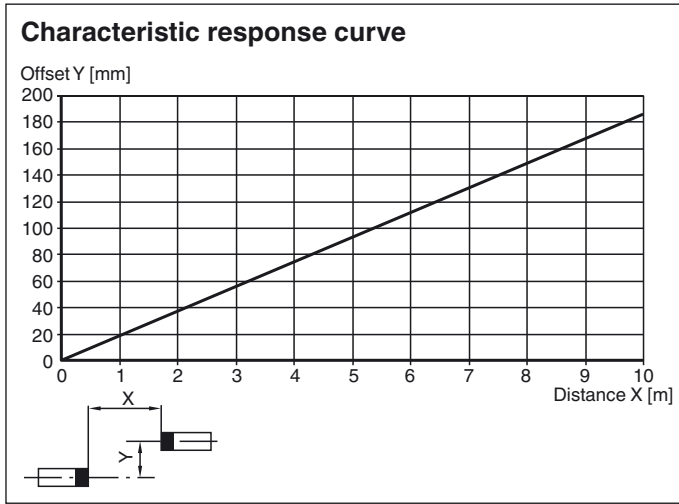

Curves/Diagrams

To aid in the detection of small objects, various apertures OMH-11-... can be placed on the sensors. This results in different detection ranges:

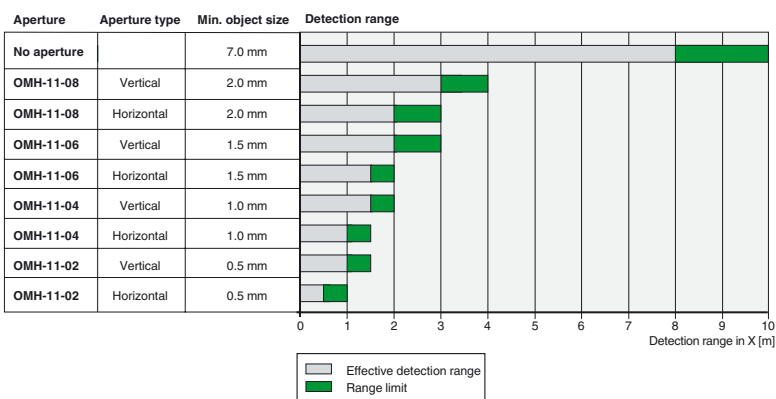

Release date: 2014-05-12 09:43 Date of issue: 2014-05-12 245917\_eng.xml

Refer to "General Notes Relating to Pepperl+Fuchs Product Information".

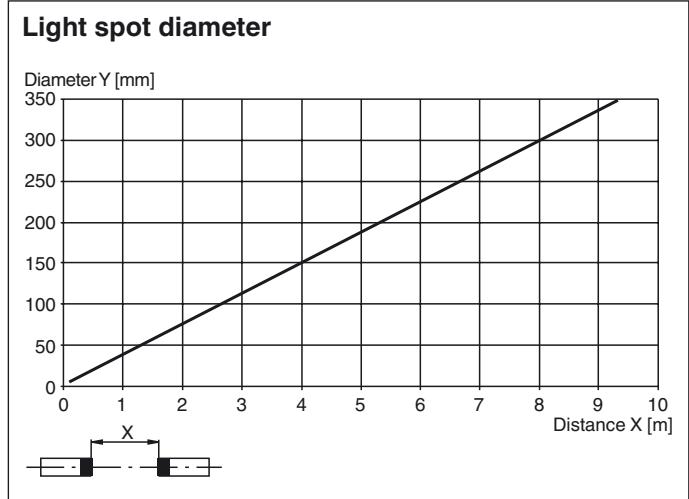

### Aperture alignment

When attaching the aperture, make sure that the sensor lens is aligned exactly with the black aperture.

