

General-Purpose Photoelectric Switches with Self-Contained Amplifier

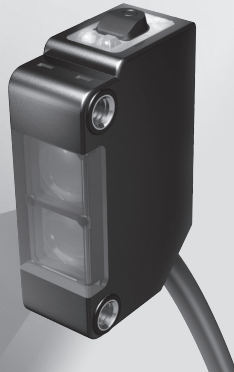

HP7 Series



- Wide range of configurations and specifications
- Improved resistance to interference (e.g., fluorescent lights)
- Threaded metal mounting holes for more reliable installation
- Different frequency thru-scan model for stress-free installation
- Auto Adjust button for situations where detection is difficult
- The HP7-C1 series has been added to the product portfolio for the detection of transparent objects.

EXPLANATION OF MAJOR FUNCTIONS AND FEATURES

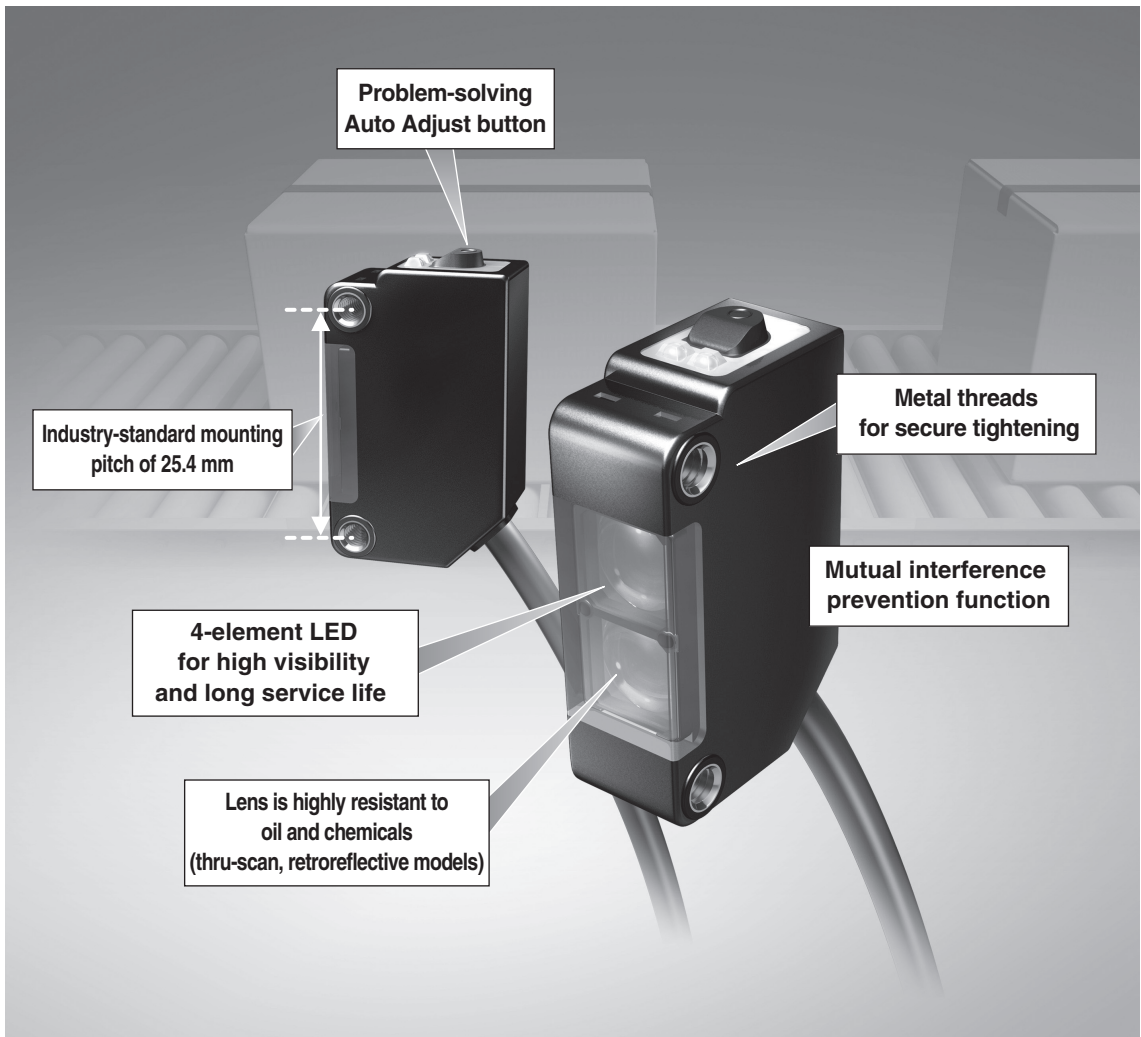

Interference suppression

The combination of a standard switch and a different frequency switch prevents interference without installing a mutual interference protection filter or reversing the orientation of one of the units. Effective for up to two units side by side.*1

Using an interference mutual protection filter, it is possible to install up to four units side by side*1 without changing the orientation of any of the units.

Automatic interference suppression allows two units to be installed in close proximity.*1

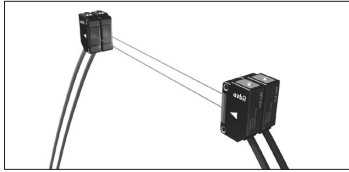

Two thru-scan switches (red and infrared)

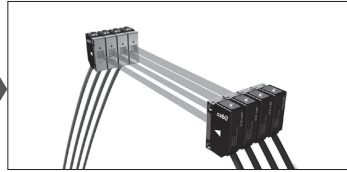

Four thru-scan switches (red)

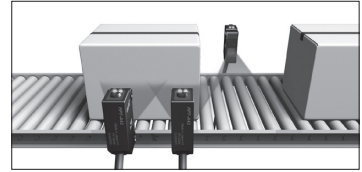

Diffuse-scan switch/retroreflective switch

*1. Subject to certain restrictions (see "Interference Suppression" in the specifications)

Simple to operate and delivers reliable detection

Long-range thru-scan models have a light-operated indicator on the front, and retroreflective models send out a visible red light beam for light axis alignment over long distances. Diffuse-scan models offer the best long-distance detection standards in the industry along with consistent detection of darker colors.

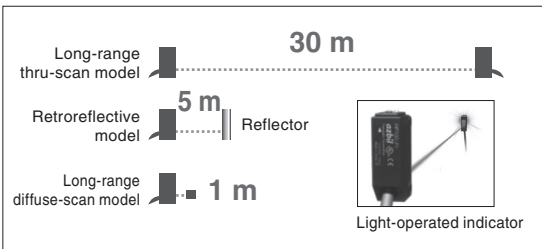

▲ Secure operating margin over a long distance

Designed for modern lighting

New algorithms achieve major improvement in resistance*2 to external optical interference.



*2. In tests conducted by the azbil Group.

High-intensity red LED

Due to high-intensity four-element LED, light spot is easy to be recognized, helping to save time during light axis adjustment.



Excellent resistance to sunlight

Switches are designed to provide a high level of resistance to sunlight (an industry-leading 40,000 lx).



How to use the Auto Adjust button

If switch operation is not consistent at factory default settings, press the Auto Adjust button to adjust sensitivity automatically.

Light seeps through semi-transparent target object

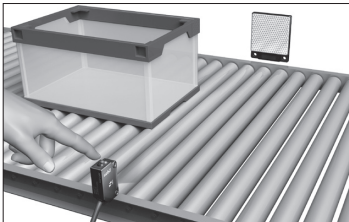

Tuning without a workpiece

False detection

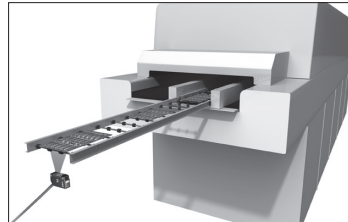

Two-point tuning

Detection in a specific position

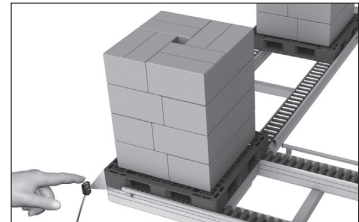



Position tuning

Note: Highly transparent objects cannot be detected. Check with actual target objects before running a machine.

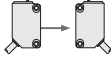
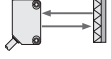
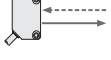
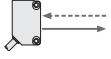

CATALOG LISTINGS

■ Base model number Connection: 2 m cable

Detection method / Configuration	Detection range / Light source	Catalog listing	Output	Different-frequency model No.	Different-frequency Output	Wiring method
Thru-scan 	30 m / Infrared	HP7-T41	NPN	HP7-T45	NPN	cable 2 m
		HP7-T42	PNP	HP7-T46	PNP	cable 2 m
	15 m / Red	HP7-T11	NPN	HP7-T15	NPN	cable 2 m
		HP7-T12	PNP	HP7-T16	PNP	cable 2 m
	15 m / Infrared	HP7-T21	NPN	HP7-T25	NPN	cable 2 m
		HP7-T22	PNP	HP7-T26	PNP	cable 2 m
	4 m / Red	HP7-T51	NPN	HP7-T55	NPN	cable 2 m
		HP7-T52	PNP	HP7-T56	PNP	cable 2 m
Retroreflective 	5 m / Red	HP7-P11	NPN	-	-	cable 2 m
		HP7-P12	PNP	-	-	cable 2 m
	3 m / Red	HP7-P51	NPN	-	-	cable 2 m
		HP7-P52	PNP	-	-	cable 2 m
Diffuse-scan 	1 m / Infrared	HP7-A43	NPN	-	-	cable 2 m
		HP7-A44	PNP	-	-	cable 2 m
	0.5 m / Red	HP7-A13	NPN	-	-	cable 2 m
		HP7-A14	PNP	-	-	cable 2 m
Wide-beam diffuse scan 	100 mm / Infrared	HP7-D23	NPN	-	-	cable 2 m
		HP7-D24	PNP	-	-	cable 2 m
	50 mm / Infrared	HP7-D63	NPN	-	-	cable 2 m
		HP7-D64	PNP	-	-	cable 2 m
Retroreflective transparent object detection 	0.5 m / Red	HP7-C11S	NPN	-	-	cable 2 m
		HP7-C12S	PNP	-	-	cable 2 m

Note: HP7-T Thru-scan: Emitter model number is HP7-E and receiver model number is HP7-R.

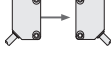
■ Connection options

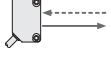
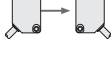
Type	Configuration Base model number	Catalog listing	HP7-P11-L050	HP7-P11-C003	HP7-P11-S003	HP7-P11-T
		Connection type	5 m cable	M12 preloaded*2 connector	Quick Lock*1*2	M8 connector
		Base model number	Base model number-L050	Base model number-C003	Base model number-S003	Base model number-T
Thru-scan 	30 m / Infrared	HP7-T41	✓	✓	-	-
		HP7-T42	✓	✓	-	-
	15 m / Red	HP7-T11	⊙	⊙	✓	✓
		HP7-T12	⊙	✓	✓	✓
	15 m / Infrared	HP7-T21	✓	✓	-	-
		HP7-T22	✓	✓	-	-
	4 m / Red	HP7-T51	✓	✓	-	-
		HP7-T52	✓	✓	-	-
Retroreflective 	5 m / Red	HP7-P11	⊙	⊙	✓	✓
		HP7-P12	✓	✓	✓	✓
		HP7-P51	✓	✓	-	-
	3 m / Red	HP7-P52	✓	✓	-	-
		HP7-A43	✓	✓	✓	✓
		HP7-A44	✓	✓	✓	✓
Diffuse-scan 	1 m / Infrared	HP7-A13	✓	-	-	-
		HP7-A14	✓	-	-	-
	0.5 m / Red	HP7-D23	✓	-	-	-
		HP7-D24	✓	-	-	-
Wide-beam diffuse scan 	100 mm / Infrared	HP7-D63	-	-	-	-
		HP7-D64	-	-	-	-
	50 mm / Infrared	HP7-C11S	✓	✓	✓	✓
		HP7-C12S	✓	✓	✓	✓
Thru-scan Different frequency 	30 m / Infrared	HP7-T45	✓	-	-	-
		HP7-T46	✓	-	-	-
	15 m / Red	HP7-T15	✓	✓	✓	✓
		HP7-T16	✓	✓	✓	✓
	15 m / Infrared	HP7-T25	✓	-	-	-
		HP7-T26	✓	-	-	-
	4 m / Red	HP7-T55	✓	-	-	-
		HP7-T56	✓	-	-	-

















✓ : available ⊙ : Always in stock; for other products, ask for delivery time.

Note: For models with SUS304 threaded metal mounting holes, the basic model number is HP7-__S.

*1. Interchangeable with OMRON Smart Click.

*2. Cable length is 300 mm.

ACCESSORIES

Name	Configuration	Description	Catalog listing	Compatible model
Reflector for retroreflective model		Reflector size 47 x 47 mm	FE-RR22 (Scanning distance 0.05 to 5 m)	^{*3} HP7-P_
		Reflector size 30.8 x 30.8 mm	FE-RR18 (Scanning distance 0.05 to 3.3 m)	^{*3} HP7-P_
		Reflector size 37 x 56 mm	FE-RR21 Scanning distance: horiz. amounting 0.05 to 5 m, vertical mounting 0.05 to 4.8 m	^{*3} ^{*4} HP7-P_
		Reflector size 47 x 47 mm	FE-RR8 (Scanning distance 0.05 to 5 m)	^{*3} HP7-P_
		Reflector size 30.8 x 30.8 mm	FE-RR15 (Scanning distance 0.05 to 3.3 m)	^{*3} HP7-P_
		Reflector size 8.6 x 29.5 mm	FE-RR23 Scanning distance: horiz. mounting 0.05 to 1.8 m, vertical mounting 0.05 to 1.3 m	^{*3} ^{*4} HP7-P_
		Reflector size 22.5 x 39.2 mm	FE-RR24 (Scanning distance 0.05 to 2.5 m)	^{*3} HP7-P_
Reflector (for retroreflective transparent object detection)		Reflector size 47 x 47 mm	FE-RR17C Scanning distance 0.05 to 0.5 m (in combination with HP7-C1_S)	HP7-C1_S
Standard bracket		Bottom-mounting L-bracket	HP-B08	All models
		Bottom-mounting L-bracket	HP-B09	All models
		Rear-mounting L-bracket	HP-B10	All models
Wraparound mounting bracket		Wraparound vertical mounting bracket	HP-B11	All models
		Wraparound horizontal mounting bracket	HP-B12	All models
Slit for thru-scan model		Vertical slit	HP-SV05 HP-SV10 HP-SV20	^{*5} HP7-T_
		Horizontal slit	HP-SH05 HP-SH10 HP-SH20	^{*5} HP7-T_
Mutual interference protection filter for thru-scan model		Mutual interference can be prevented by changing the polarizing direction of 2 adjacent emitter-receiver pairs	HP-U02	^{*6} HP7-T1_/T5_

^{*3}. Scanning distance when used with **HP7-P1_**.

^{*4}.

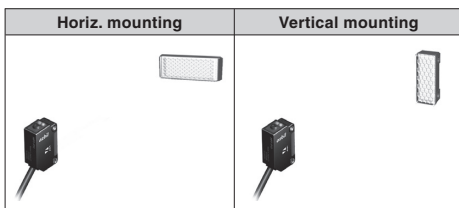

^{*5}. Scanning distance of thru-scan switch with slit.

Slit width	Catalog listing	Catalog listing of compatible switches	
		HP7-T1_ / HP7-T2_	HP7-T5_
0.5 × 6.4 mm	HP-S_05	1.2 m	0.4 m
1.0 × 6.4 mm	HP-S_10	3 m	0.7 m
2.0 × 6.4 mm	HP-S_20	5 m	1.5 m

^{*6}. Scanning distance of thru-scan switch with mutual interference protection filter.

Catalog listing	Catalog listing of compatible switches	
	HP7-T1_	HP7-T5_
HP-U02	7 m	1.8 m

SPECIFICATIONS

Catalog listing	NPN	HP7-P51	HP7-P11	HP7-T51	HP7-T11 (Red) HP7-T21 (Infrared)	HP7-T41	HP7-A13	HP7-A43	HP7-D23	HP7-D63	HP7-C11S
	PNP	HP7-P52	HP7-P12	HP7-T52	HP7-T12 (Red) HP7-T22 (Infrared)	HP7-T42	HP7-A14	HP7-A44	HP7-D24	HP7-D64	HP7-C12S
Detection method	Retroreflective ²			Thru-scan			Diffuse-scan				Retroreflective transparent object detection
Power supply	10.2 to 26.4 Vdc (Ripple 10% max.)										
Power consumption	14 mA max.		22 mA max.	25 mA max. (Red) 30 mA max. (Infrared)	32 mA max.	14 mA max.	17 mA max.	17 mA max.		15 mA max.	
Scanning distance	3 m (with FE-RR8 reflector)		5 m (with FE-RR8 reflector)	4 m	15 m	30 m	0.5 m	1 m	100 mm	50 mm	0.05 to 0.5 m (when combined with FE-RR17C reflector)
Target object	Opaque object 80 mm dia. min.(with FE-RR8 reflector)			Opaque object 12 mm dia. min.			Standard target object: 200 × 200 mm paper, 90 % reflectivity				10% light blockage or more, 50 × 50 mm or more (when combined with FE-RR17C reflector)
Differential travel	-			-			20% max. (at rated scanning distance)				-
Operation mode	Light-operate / Dark-operate selectable by operation button										
Output mode ¹	NPN open collector / PNP open collector										
Control output	Switching current: preloaded. Preloaded connector type 100 mA (Resistance load) M8 connector type and low-temperature cable type 50 mA (Resistance load) Output withstand voltage: 30 V Residual voltage: 2 V or lower (at switching current of 100 mA/50 mA), 1.1 V or less (at switching current below 10 mA)										Switching current: 50 mA or lower (Resistive load) Output withstand voltage: 30 V Residual voltage: 1 V or less
Response time ³	1 msec		1 msec (Different frequency model: 3 ms)			1 msec				1 msec	
Light source	Red, 4 elements (Wavelength approx. 645 nm)		Red, 4 elements (Wavelength approx. 645 nm)	Red, 4 elements (Wavelength approx. 645 nm) Infrared (Wavelength approx. 860 nm)	Infrared (Wavelength approx. 860 nm)	Red, 4 elements (Wavelength approx. 645 nm)	Infrared (Wavelength approx. 860 nm)				Red, 4 elements (Wavelength approx. 645 nm)
Scanning angle	0.5 to 10°			2 to 20°			-				Switch: 0.5° to 10°
Indicator	Output ON: orange indicator ON. At stable light and stable dark: green indicator Thru-scan emitter: power indicator, 30 m thru-scan receiver: light-operated indicator on front										
Ambient light immunity	Incandescent lamp: 10,000 lux max. Sunlight: 40,000 lux max. HP7-T_ , HP7-P_ , HP7-C_ : Minimum angle of incidence of surrounding light = 5° HP7-A_ : Minimum angle of incidence of surrounding light = 15° HP7-D_ : Figures apply to indirect illumination.										
Operating temperature	-30 to + 55°C (without freezing or condensation) ⁶										-10 to + 55°C (without freezing or condensation) ⁶
Storage temperature	-40 to + 70°C (without freezing or condensation)										
Operating humidity	35 to 85% RH (without freezing or condensation)										
Insulation resistance	20MΩ min. (at 500Vdc)										
Dielectric strength	1,000Vac 50/60Hz for one minute between electrically live metal and case										
Vibration resistance	10 to 55Hz, 1.5 mm peak-to-peak amplitude, 2 hours each in X, Y, and Z directions										
Shock resistance	500 m/s ² 10 times each in X, Y and Z directions										
Sensitivity adjustment	Operation button										
Protective structure	IP67 (IEC standard)										
Wiring method	HP7-_ : preloaded 2 m, HP7-_L050 : preloaded 5 m, HP7-_C003 : M12 preloaded connector 30 cm, HP7-_T : M8 connector										
Circuit protection	Error prevention circuit at power on (max. 60 ms) Full wiring error protection										Error prevention circuit at power on (max. 80 ms) Power supply reverse polarity protection, output short-circuit protection
Interference suppression ⁵	Diffuse-scan, retroreflective, retroreflective transparent object detection models up to 2 units. Thru-scan models with different frequencies, up to 2 units. Thru-scan models with mutual interference prevention filter ⁴ (for red), up to 2 units. Different frequency models + mutual interference prevention filters (for red), up to 4 units.										

*1. An FET is used for output

*2. Retroreflective switches feature polarizing filters; however, performance may be affected by highly reflective objects and objects that interfere with polarization.

*3. Response time may be longer if affected by light from other switches.

*4. Mutual interference protection filters are for red light source.

*5. Avoid operating diffuse-scan switches head-on when using gang mounting.

*6. In a low-temperature environment (0° or below), the standard cable will harden. Low temperature cables are available. Contact our branch or sales office to order.
(Not available for **HP7-C1_S**.)

OUTPUT CIRCUIT DIAGRAM (Note that a FET is used for output)

Thru-scan emitter

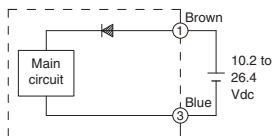

(NPN output type)
Polarized retroreflector model,
Thru-scan receiver, Diffuse-scan mode

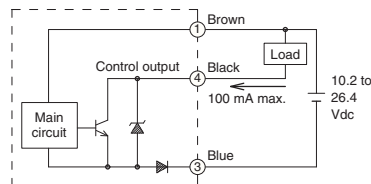

(PNP output type)
Polarized retroreflector model,
Thru-scan receiver, Diffuse-scan mode

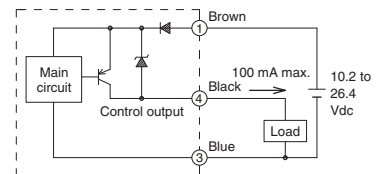

CHARACTERISTICS DIAGRAMS (typical examples)

Thru-scan models (HP7-T1_/T2_/T5_)

Excess gain (Light received over the required amount)

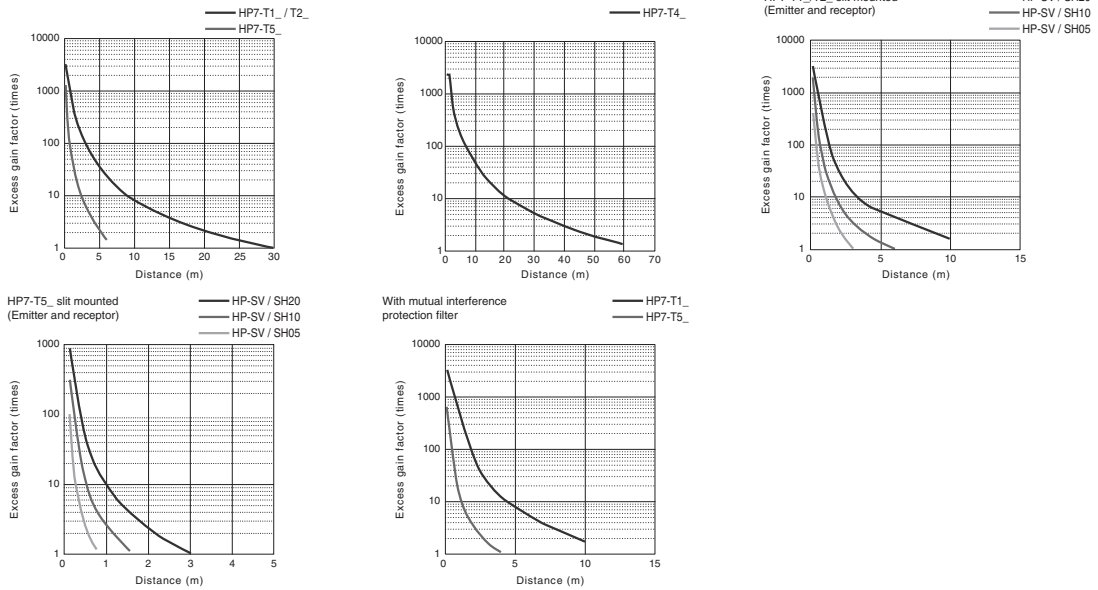

Parallel displacement

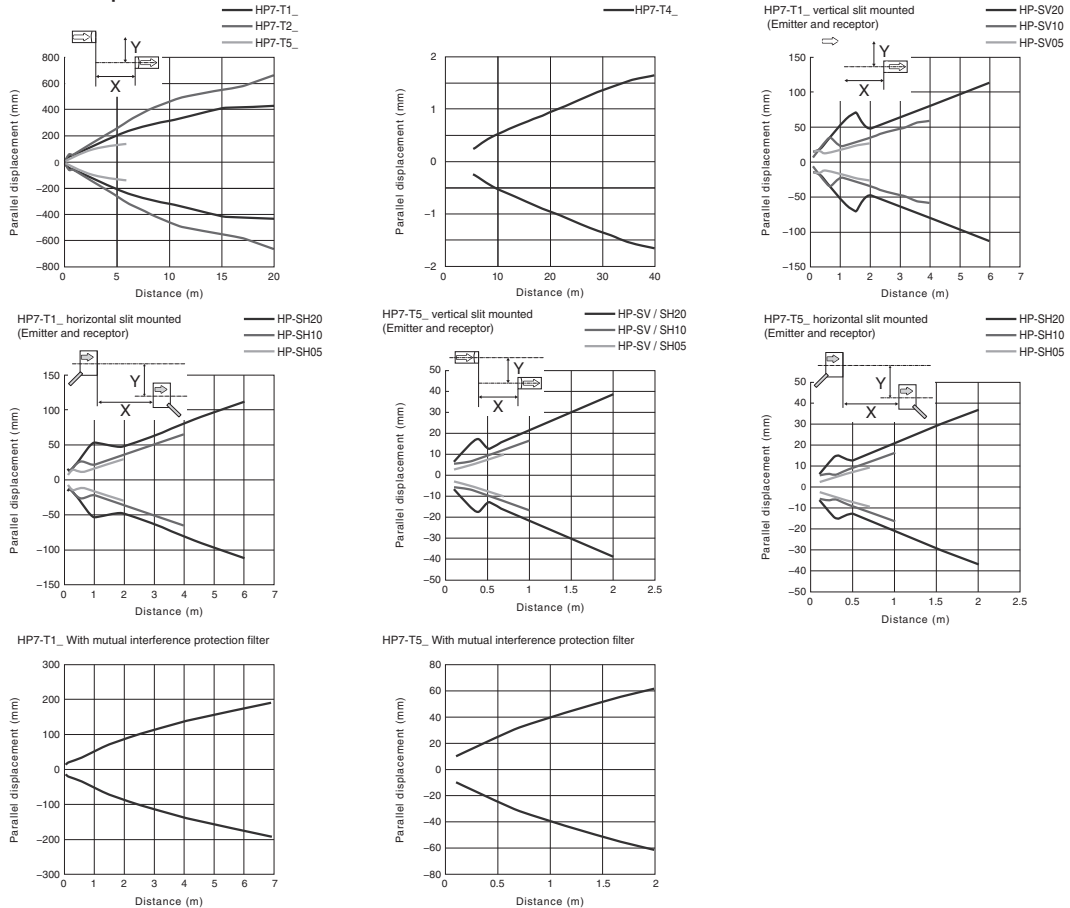

Note: The above summary of key characteristics should not be construed as a performance guarantee. Always test first under actual conditions and allow leeway as appropriate.

Retroreflective models (HP7-P1_)

Excess gain

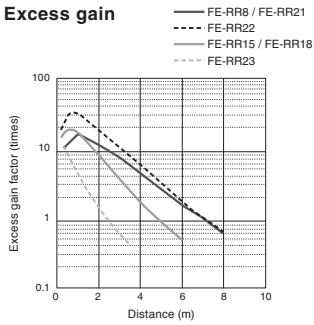

Parallel displacement

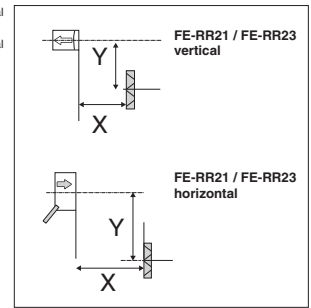
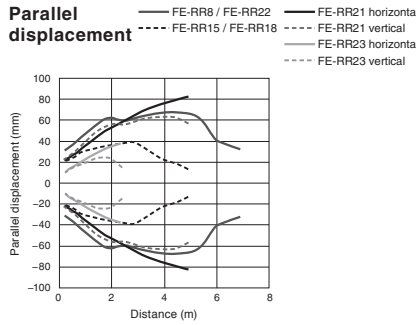

Diffuse-scan models (HP7-A1_ / A4_)

Excess gain

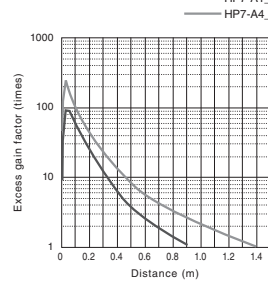

Target specifications

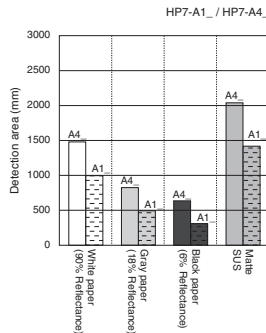

When used with highly reflective backgrounds, tilting the switch may improve background suppression.

Detection area characteristics

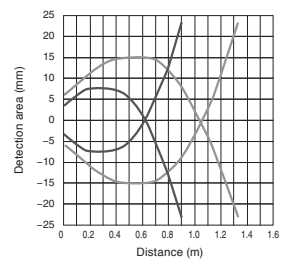

Background interference during tuning

(No workpiece) (Background = matte SUS)

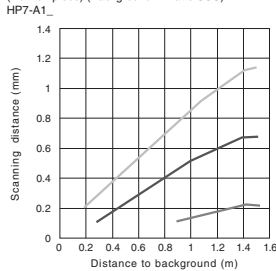

Background interference during tuning

(No workpiece) (Background = matte SUS)

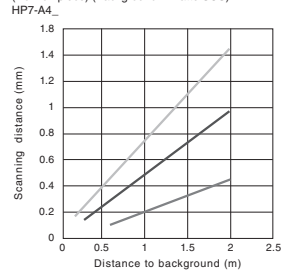

How to interpret the table

Example: Tuning (without a workpiece) of model HP7-A1_ against a matte SUS background at 1 m where white paper target is detected at distances of up to approx. 0.5 m.

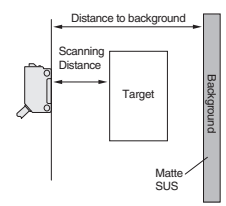

Wide-beam diffuse scan model (HP7-D2_ / D6_)

Wide-beam diffuse scan model

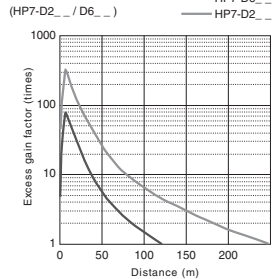

Detection area characteristics

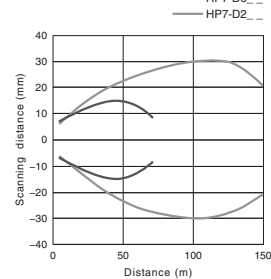

Retroreflective transparent object detection model (HP7-C1_ S)

Parallel displacement

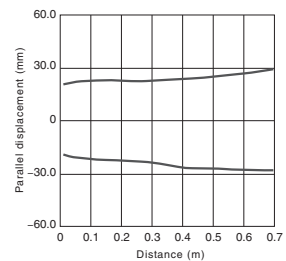

Note: The above summary of key characteristics should not be construed as a performance guarantee. Always test first under actual conditions and allow leeway as appropriate.

■ Pleated and M12 pleated connector types

● Retroreflective / Retroreflective transparent object detection model / Diffuse-scan

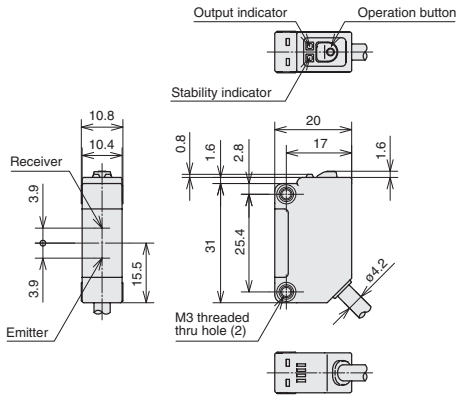

● Thru-scan emitter

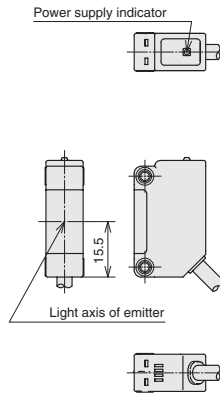

● Thru-scan receiver

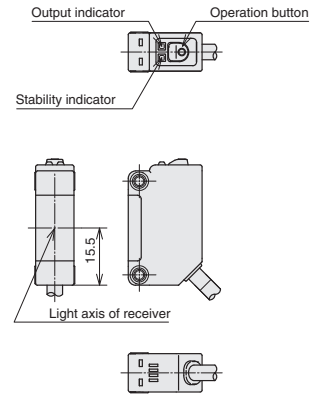

■ Connector part

HP7-___C___ (M12 prelead connector)

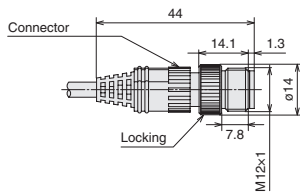

HP7-___S___ (Quick Lock prelead connector)

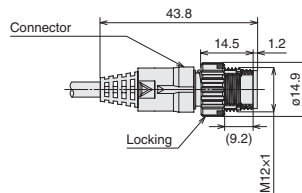

■ M8 connector types

● Retroreflective / Retroreflective transparent object detection model / Diffuse-scan

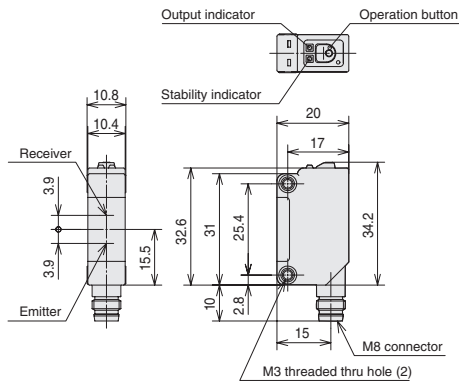

● Thru-scan emitter

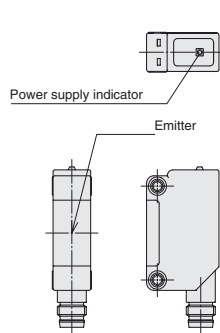

● Thru-scan receiver

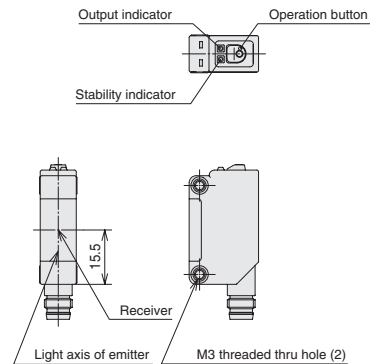

■ Slit

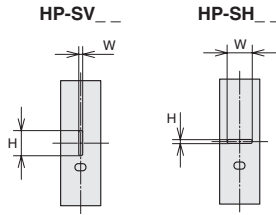

Catalog listing	Width (mm)	Height (mm)
HP-SV05	0.5	6.4
HP-SV10	1.0	6.4
HP-SV20	2.0	6.4
HP-SH05	6.4	0.5
HP-SH10	6.4	1.0
HP-SH20	6.4	2.0

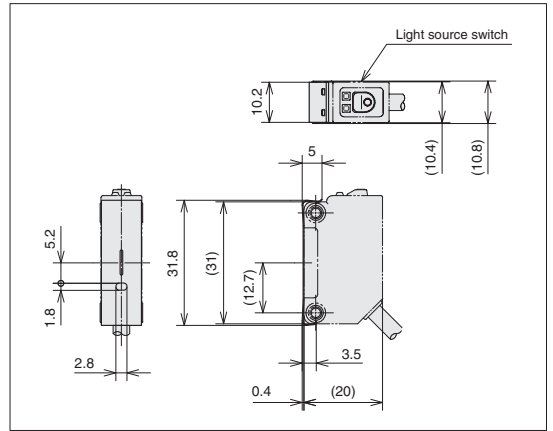

■ Filter

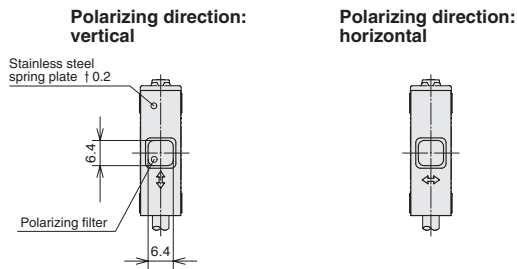

■ Reflector (Sold separately)

FE-RR8

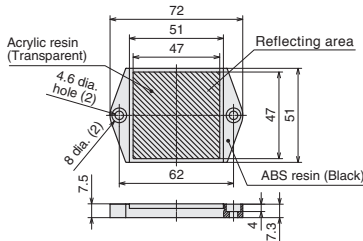

FE-RR15

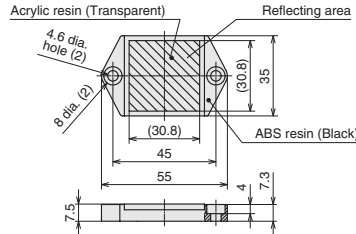

FE-RR18

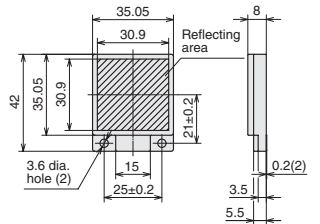

FE-RR21

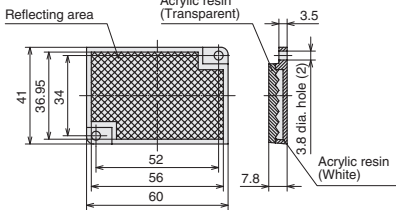

FE-RR22

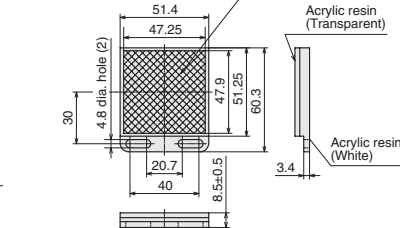

FE-RR23

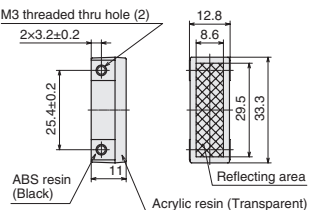

FE-RR24

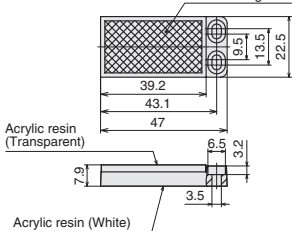

FE-RR17C

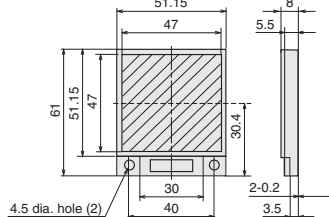

■ Bracket (sold separately)

Button-mounting
L-bracket (HP-B08)

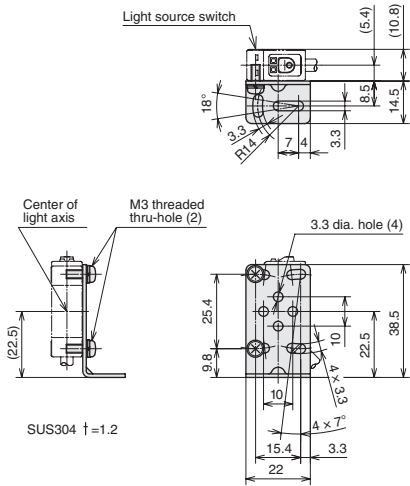

Button-mounting
L-bracket (HP-B09)

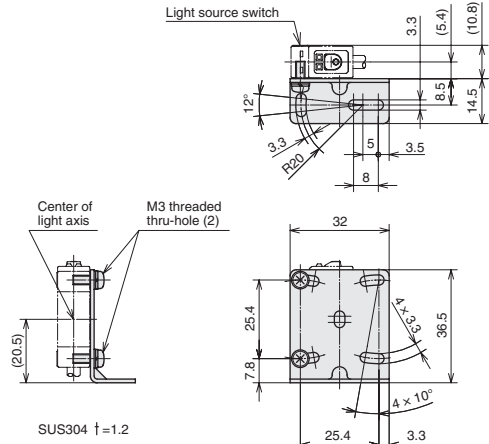

Rear-mounting
L-bracket (HP-B10)

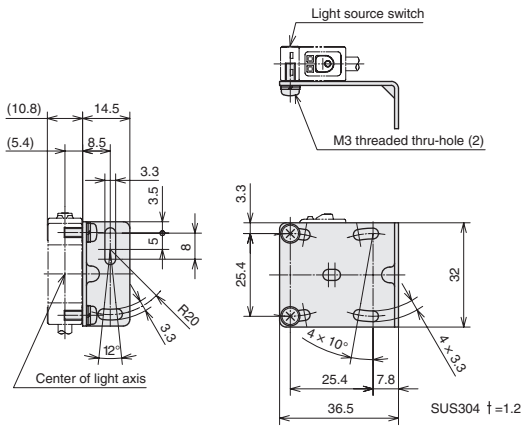

Wraparound vertical
mounting bracket (HP-B11)

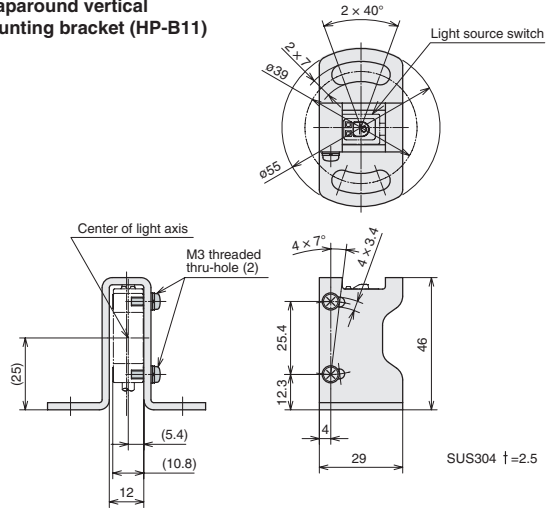

Wraparound horizontal
mounting bracket (HP-B12)

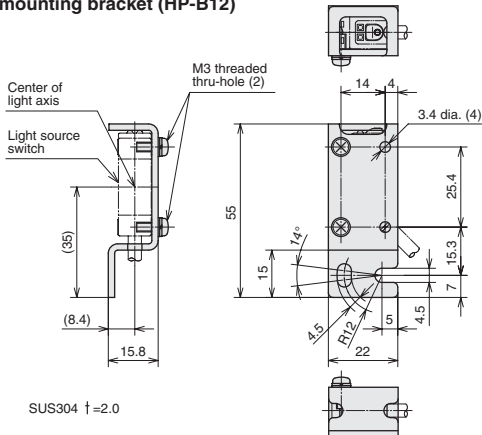

The operation method

Tuning without a workpiece

After light axis adjustment, if target objects cannot be reliably detected at the factory default sensitivity (maximum sensitivity), adjust according to the instructions below.

(1) Thru-scan models and retroreflective models

Adjust in the following cases. Switch sensitivity will be set automatically so that it operates at about half the light intensity as when there is no target object.

- The objects are transparent or translucent
- The objects have holes or notches
- Not enough light is blocked by target objects because light reaches the switch from the surroundings.

Note: For thru-scan models, if the set scanning distance is shorter than the following amounts, light intensity may be too strong, causing the switch to enter the state described in "Indicator lamp flashes repeatedly."

HP7-T1□□□ and HP7-T2□□□: 1 m. HP7-T5□□□: 0.3 m.

(2) Diffuse-scan models

Adjust in the following cases. Switch sensitivity will be set automatically so that it operates at about twice the light intensity as when there is no target object.

- Because of light from the surroundings, the switch receives light even when there is no target object.

(3) Retroreflective transparent object detection models

Before adjusting, allow 3 minutes for warm-up after turning the power on.

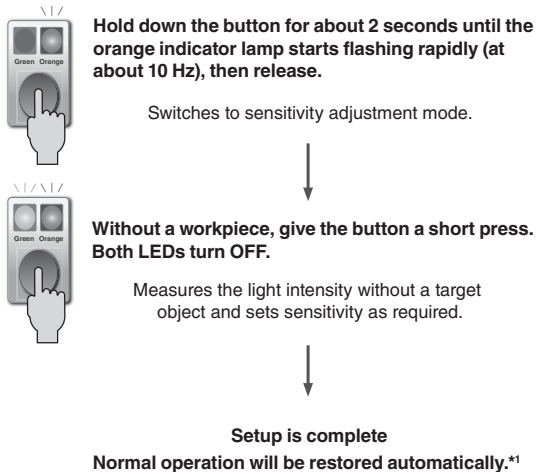

*1. If the indicator lamp flashes repeatedly, repeat the procedure as described under Indicator lamp flashes repeatedly.

2-point tuning

If target objects cannot be reliably detected even after tuning without a workpiece, adjust as shown below.

(1) Thru-scan models and retroreflective models

As a result of tuning without a workpiece, target objects do not block enough light.

(2) Diffuse-scan models

As a result of tuning without a workpiece, the switch does not receive enough light from target objects.

The switch will be set automatically so that it operates at a light intensity that is between the intensity with a target object and the intensity without a target object.

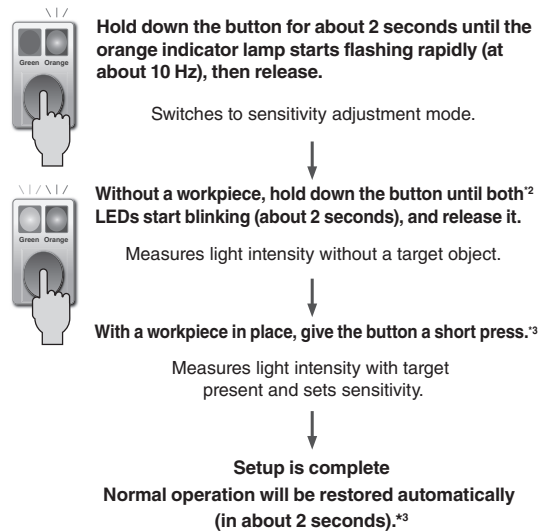

*2. It is OK to reverse the order of the two states (target present/target absent).

*3. If the indicator lamp flashes repeatedly, repeat the procedure as described under Indicator lamp flashes repeatedly

LO/DO Changeover

The operating mode is set to default at the factory, but can be changed as outlined below. Light-operate changes to Dark-operate, and Dark-operate changes to Light-operate.

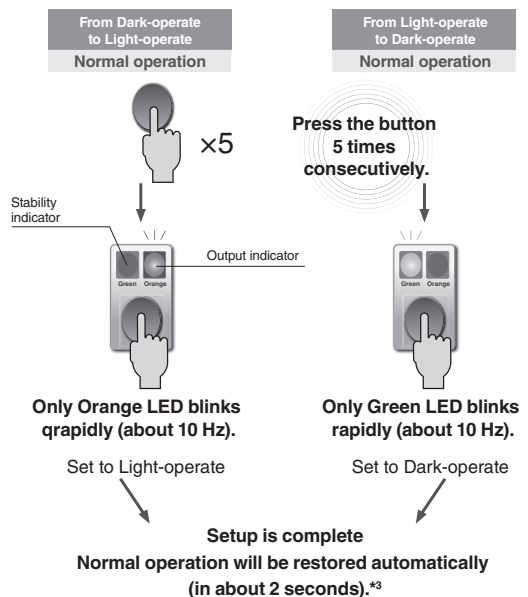

Position tuning

For diffuse-scan detection at any desired specific position, use position tuning. (The positioning accuracy is 15 % at maximum.)

HP7-A1□□: Distance between 200 mm and 500 mm

HP7-A4□□: Distance between 200 mm and 1,000 mm

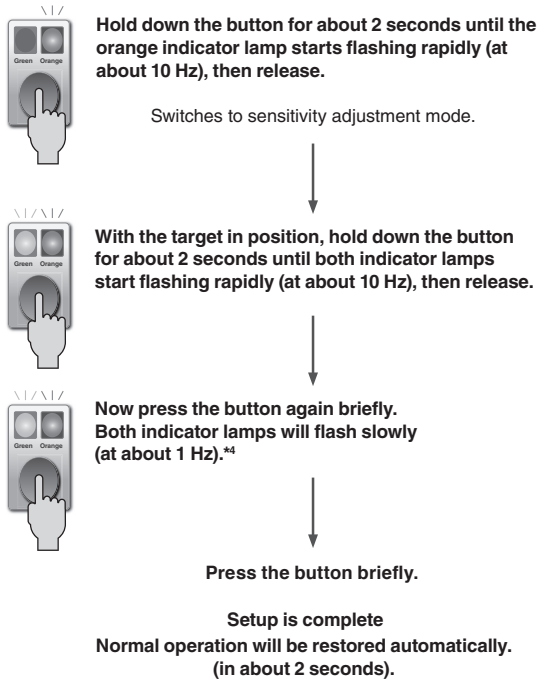

*4. If the orange light continues to flash slowly (at about 1 Hz), repeat the procedure as described under Indicator lamp flashes repeatedly.

Checking LO/DO

Use the procedure shown below to check the current operating mode.

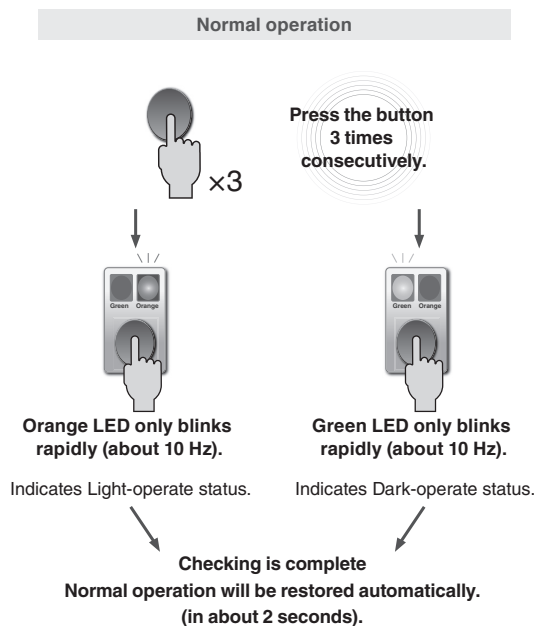

When confused, or to restore the default setting (max. sensitivity)

If you wish to restore the factory default sensitivity, or if you lose track of your progress while making adjustments, do the following to restore the factory default from any flashing status.

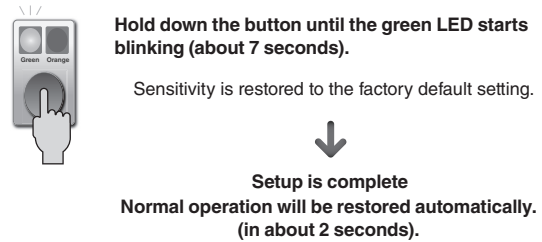

Indicator lamp flashes repeatedly

The table below lists the various states indicated by repeated flashing together with suggested responses. If the problem is not resolved, it may be necessary to try a different model of switch.

LED indicators	Status	Solution
<p>Orange indicator flashes rapidly or both indicators flash rapidly (at about 10 Hz)</p>	Tuning in progress	Hold down the button until the green indicator flashes rapidly (about 7 seconds) to restore the factory default setting (Maximum sensitivity).
<p>Orange LED only blinks slowly. (at about 1 Hz)</p>	Tuning Without a tuning workpiece Tuning failed - insufficient light	Thru-scan and retroreflective models Press the button once to revert to normal operation at the pre-tuning sensitivity. Adjust the light axis and then repeat the tuning procedure.
	2-point tuning Tuning failed - insufficient light at both points	Press the button once to revert to normal operation at the pre-tuning sensitivity. Thru-scan and retroreflective models Adjust the light axis and then repeat the tuning procedure. Diffuse-scan models Move the switch closer to the target to boost the reflected light intensity and then repeat the tuning procedure.
<p>Both LEDs blink slowly at the same time. (at about 1 Hz)</p>	2-point tuning Tuning failed - too much light at both points	Thru-scan models Press the button once to revert to normal operation at the pre-tuning sensitivity. Reduce the amount of light by using slits or tilting the optical axis, and then repeat the tuning procedure.
	Tuning without workpiece Setup is done but light intensity is too high. Stability Indicator may not light up.	Press the button once to revert to normal operation based on the tuning results. Use a workpiece to verify that the switch works properly. Thru-scan models Reduce the amount of light by mounting slits or tilting the optical axis, and then repeat the tuning procedure. Diffuse-scan models Minimize the reflected light by painting the background black, and then repeat the tuning procedure.
<p>Both LEDs blink slowly at the same time. (at about 1 Hz)</p>	Tuning without workpiece Setup is done but light intensity is too low. The switch may not operate.	Thru-scan and retroreflective models Press the button once to revert to normal operation based on the tuning results. Adjust the light axis and then repeat the tuning procedure.
	2-point tuning After 2-point tuning, the difference in light intensity between the two points is too small. The switch may not operate.	Thru-scan, retroreflective, and diffuse-scan models Press the button once to revert to normal operation based on the tuning results. Check operation before use.

CONNECTOR WITH CABLE

PA5 Series cable

Be sure to use a PA5 Series connector with cable when connecting a preleaded connector or connector-type switch.

● PA5 Series connector with cable

Shape	Power supply	Cable properties	Cable length	Catalog	Lead colors
	DC	Vinyl-insulated cable with high resistance to oil and vibration (UL/NFPA79 CM, CL3)	2 m	PA5-4I SX2SK	1: brown, 2: white, 3: blue, 4: black
			5 m	PA5-4I SX5SK	1: brown, 2: white, 3: blue, 4: black
			2 m	PA5-4I LX2SK	1: brown, 2: white, 3: blue, 4: black
			5 m	PA5-4I LX5SK	1: brown, 2: white, 3: blue, 4: black

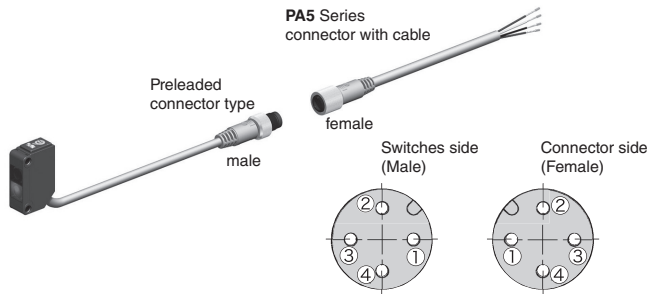

● Tightening the connector

Align the grooves and rotate the fastening nut on the PA5 connector by hand until it fits tightly with the connector on the switches side.

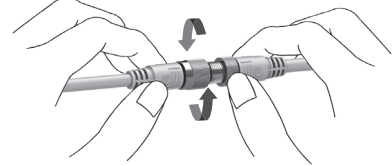

PA7 Series cable

Be sure to use a PA7 Series connector with cable when connecting Quick Lock type switch.

● PA7 Series connector with cable

Shape	Power supply	Cable properties	Cable length	Catalog	Lead colors
	DC	Vinyl-insulated cable with high resistance to oil and vibration (UL/NFPA79 CM)	2 m	PA7-4I SX2SK	1: brown, 2: white, 3: blue, 4: black
			5 m	PA7-4I SX5SK	1: brown, 2: white, 3: blue, 4: black

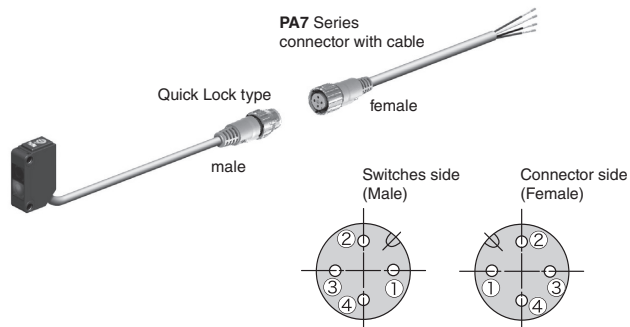

● Tightening the connector

Align the triangle mark and mate the male and female connector then rotate 45 degree to match the keys on the rings by hand.

Switches side PA7 connector side

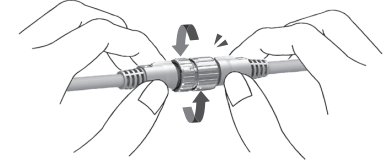

Interchangeable with Smartclick made by OMRON Corporation.
Smartclick Smartclick is trademark of OMRON Corporation.

PA8 Series cable

Be sure to use a PA8 Series connector with cable when connecting a M8 preleaded connector or M8 connector type switch.

● PA8 Series connector with cable.

Shape	Power supply	Cable properties	Cable length	Catalog	Lead colors
	DC	Vinyl-insulated cable with high resistance to oil and vibration	2 m	PA8-4I SX2MK	1: brown, 2: white, 3: blue, 4: black
			5 m	PA8-4I SX5MK	1: brown, 2: white, 3: blue, 4: black

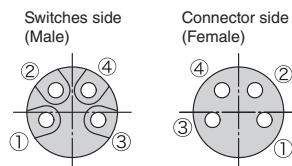

● Tightening the connector

Align the grooves and rotate the fastening nut on the PA8 connector by hand until it fits tightly with the connector on the switches side.

Retroreflective transparent object detection

Tips for using the **HP7-C** retroreflective transparent object detection model

Reflector

- Use the switch in combination with the specified reflector.

Detectable objects

- Objects should block 10 % or more of the light.

Setup method

- After adjusting the light axis, tune without a workpiece (not using a target object).
The switch will be automatically set to the optimum sensitivity for detecting transparent objects.

Installation know-how

- Depending on the target object, detection may be unreliable even after performing tuning without a workpiece.
If so, try the following.

CASE ① If reflection from the target object is strong, install the photoelectric switch at an angle to the target object.

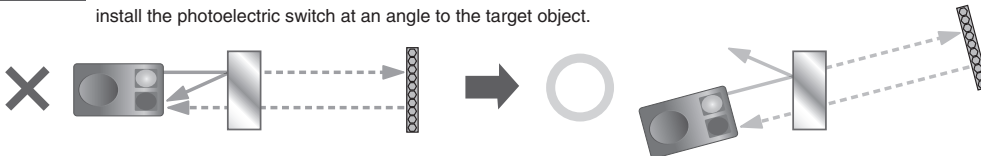

CASE ② If objects such as plastic bottles cannot be detected because the light passes through them or is intensified, adjust the positions of the photoelectric switch and the reflector.



CASE ③ To detect round objects, install the switch as shown below.

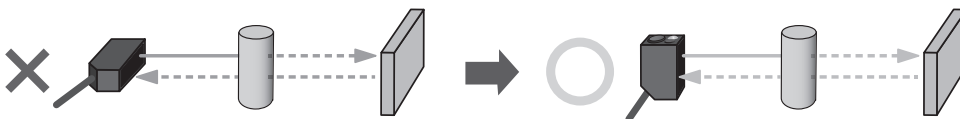

- As light axis misalignment affects the temperature characteristic, move the photoelectric switch back and forth and up and down to locate the center of the range where the green indicator light turns on.
- When installing the **FE-RR17C** transparent object detection reflector, do not tighten to a torque of more than 1 N·m.

Notes for reliable detection

- Wait 3 minutes after power on before tuning or using the switch. This allows the internal temperature to stabilize.
- If the ambient temperature varies after tuning and detection becomes unreliable, retune the switch.
- Over the course of long-term use, variations in light intensity may be caused by factors such as dirt on the switch/reflector or light axis misalignment due to vibration. Regular maintenance and cleaning will prevent such problems.

HANDLING



- Warning
- Designed for general industrial use, not for safety equipment.
 - Do not connect this device to AC power. Doing so might cause rupture or burnout.

1. Handling precautions

- Tighten the mounting screws to a maximum torque of 0.8 N-m.
- After the power is turned on, the switch starts to operate in 60 ms at most (80 ms for **HP7-C**).
- For outdoor use, put inside a case, etc., to prevent direct exposure to sunlight and rain water.
- Avoid locations with strong vibration or impact. They may cause optical axis misalignment.
- Shield the lens from water and oil. Water or oil on the lens can cause faulty operation.
- Do not expose to chemicals (Organic solvents, acids, alkalis).
- Use a cover or change the mounting direction to ensure correct switch operation if there is heavy interference from ambient light.
- When used in a very dusty environment, be sure to take countermeasures to keep dust away from the lens surface by using a sealed case or air purging.
- Even when oil-resistant cable is used, do not use in a location subject to continuous splashing by water or oil, or where the unit is immersed in liquid. Ensure that the end of the cable is not subject to splashing by water or oil.
- A bend in the cable immediately after it exits the device should have a radius of at least 30 mm. Also, avoid use in which the cable receives repeated bending stress. Do not apply a force of 50 N or higher (30 N or higher for low-temperature cable types).
- Do not pull the cable with excessive force (> 50 N). cable disconnection can cause burnout. Do not apply a force of 50 N or higher (30 N or higher for low-temperature cable types).
- Photoelectric switches are assembled with precision. Never strike with another object. Especially if the lens surface is scratched or cracked, switch performance may decline.
Handle with care.
- To clean the lens or reflector, wipe lightly with a soft, clean cloth or cloth moistened with water. Do not use an organic solvent such as alcohol, benzene, acetone, or thinner.
- When multiple photoelectric switches are used close together, mutual interference may occur. After installation, check the operation carefully before use.
- Standard cable might get hardened under 0°C. Do not bend or apply shock / vibration under 0°C. Low temperature cable is available.
- Switch might not reliably detect highly reflective objects or objects that disrupt polarization (ex.: Object covered with transparent film). In such a case try the following countermeasures:

- Sample countermeasures ---
- Mount the switch at an angle to the target object.
 - Increase the distance between the switch and the target object.
 - Tune the switch without a workpiece.

2. Wiring precautions

- If a cable extension is necessary, use wire at least 0.3 mm² in cross-sectional area and at most 100 m long.
- If the cable of photoelectric switch are laid in the same conduit as high-voltage or power lines, inductance may cause malfunction or damage. Isolate the photoelectric switch's cable or lay it in a separate conduit.
- When using a commercially available switching regulator, ground the frame ground and ground terminals. If used without grounding, switching noise may cause faulty operation.
- When using a load which generates an inrush current above the switching capacity, such as a capacitive load or incandescent lamp, connect a current-limiting resistor between the load and the output terminals.
Otherwise, the output short-circuit protection function may be activated.

3. Adjustment method

Thru-scan model and polarized retroreflective model

1. Move the emitter and receiver (Main body and reflector in case of a retroreflective model) up, down, right, and left, and then align them in the center of the area where the green stable-operation indicator lights up.
2. Check switch operation using a target object then use the Auto Adjust button to adjust the sensitivity setting.

Diffuse-scan model

1. Mount the photoelectric switch pointing toward the desired detection position.
2. Check switch operation using a target object then use the Auto Adjust button to adjust the sensitivity setting.