

podis[®] CON

podis[®] CON Power Bus System

Installation system for decentralized power distribution

Instructions

Product and system description

Doc. no. BA000369

Last updated: 02/2016 (Rev. B)

Copyright

This document is copyright-protected. The rights derived from this copyright are reserved for Wieland Electric GmbH. Reproduction of this document or parts of this document is only permissible within the limits of the statutory provision of the Copyright Act. Any modification or abridgment of the document is prohibited without the express written agreement of Wieland Electric GmbH.

1	About this manual	5
	Target groups and qualification of personnel	5
	Presentation of safety-relevant information	5
2	System overview	6
3	podis CON flat cable	9
3.1	Current-carrying capacity of flat cables and points of contact	9
3.2	Notes on routing of flat cables	10
	General instructions and precautionary measures	10
	Monitoring and safety devices	10
	Routing instructions	11
	Mounting and routing of flat cables with cable clamps	12
3.3	Cutting flat cables to length	12
3.4	Stripping of flat cables	13
	Stripping of flat cable for attachment of cable end cap	14
	Stripping of flat cables for connection to the distributor module or terminal strips	14
3.5	Termination of the flat cable	16
3.6	Making the connection	17
	Conductor assignment	18
4	Rapid assembly using basket trays	19
4.1	Example using flat cable outlet	20
5	Feeding into a power bus segment and power tapping	22
5.1	Feed directly from the switchgear cabinet	22
	Insertion, retaining and connection of flat cable inside switchgear cabinet	22
5.2	Feeding through distributor module	23
5.3	Feeding through 7-pin connection module	23
	Mounting of connection and tapping modules	24
5.4	Connection modules	26
5.5	Flat cable outlet, pluggable (power tap)	26
	Protective lid	27
6	Attachment of pluggable devices and functional modules	28
6.1	Connector for round conductor connection	28
6.2	Connection of multiple flat cable sections	28
6.3	Socket module	29
6.4	Drive control systems <i>podis</i> [®] MOT, <i>podis</i> [®] MCU	29
6.5	Maintenance switch <i>podis</i> [®] SWITCH	30
6.6	LED lights <i>podis</i> [®] LED	30
7	Accessories	31
	Sealing sleeve	31
	Protective lid	31
	Cable bushing	31
	Cable glands	31
	Cable clip	32

Wieland Electric GmbH
Brennerstraße 10-14
96052 Bamberg, Germany

Phone: +49 (0) 9 51 93 24-0
Fax: +49 (0) 9 51 93 24-1 98
E-mail: info@wieland-electric.com
<http://eshop.wieland-electric.com>
[http:// www.wieland-electric.com](http://www.wieland-electric.com)

Hotline for technical support

Contact person for: technical questions regarding accessories, function, product properties, and usage options

Phone: +49 (0) 9 51 / 93 24-9 95
Fax: +49 (0) 9 51 / 93 26-9 96
E-Mail: at.ts@wieland-electric.com

1 About this manual

This manual provides you with support regarding the project planning and development of electrical facilities as well as the installation and commissioning of *podis*CON-Modules. It contains information as to how the devices can be used.

This document contains the information required for the intended use of the device as well as technical data. It describes the technical characteristics, the usage of the device as well as the boundary conditions. Case studies that are used in practice are presented as part of illustrative application examples.

Target groups and qualification of personnel

Commissioning and installation of components should only be carried out by specialized technicians. The legal and valid regulations for such types of installations must be considered.

Therefore, the system manual is targeted at the following:

- Those who can verify that they have the corresponding training and already have corresponding basic knowledge of planning and commissioning of electrical installations.
- System integrators
- Electricians

Presentation of safety-relevant information

Information that warns of personal injury or property damage are emphasized by safety instructions.

Warning of personal injury

Safety instructions that warn of personal injury are indicated by the signal word **DANGER**. Failure to observe can cause serious health effects or even death.

Example:

 DANGER
<ul style="list-style-type: none"> • Only qualified electricians may install and commission this device. • Do not open the device. Do not introduce any foreign objects. Keep device away from water and fire. • Only connect or disconnect the device when the device is powered down. • The relevant standards, guidelines, regulations and provisions of the respective country must be observed.

Warning of property damage

Text that warns of property damage is indicated by the signal word **CAUTION**.

Example:

 CAUTION
In the event of damage to the unit or any malfunctions, please contact your Wieland sales partner or an authorized dealer.

General instructions

Texts that contain general instructions on installation and handling are marked with the signal word **NOTE**

Example:

 NOTE
Openings in the sheath of the flat cable must be closed by a sealing collar.

2 System overview



1. Cable end cap
2. Cable bushing
3. 7-pin connection module
4. Distributor module
5. Front plug connector
6. 2-pin and 3-pin connection module
7. Pluggable outlet, 7-pin with connector
8. Flat cable
9. Sealing sleeve
10. 7-pin connection module with repair switch

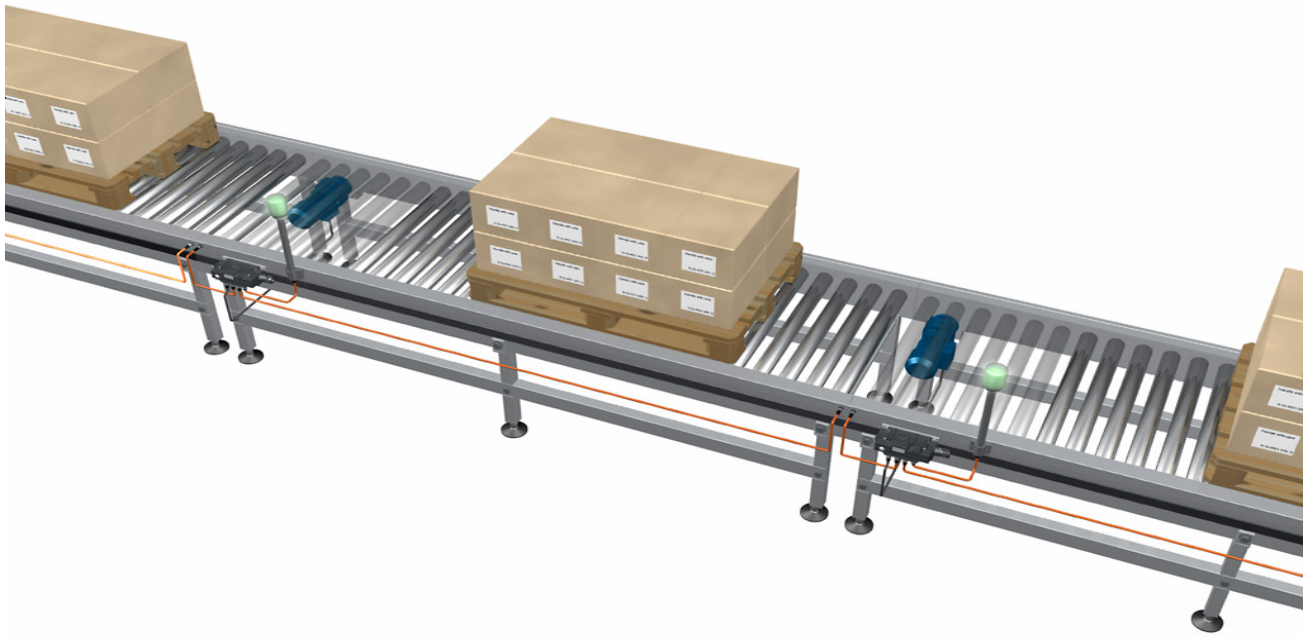

Example of a *podis* system configuration for a conveyor system

2 System overview

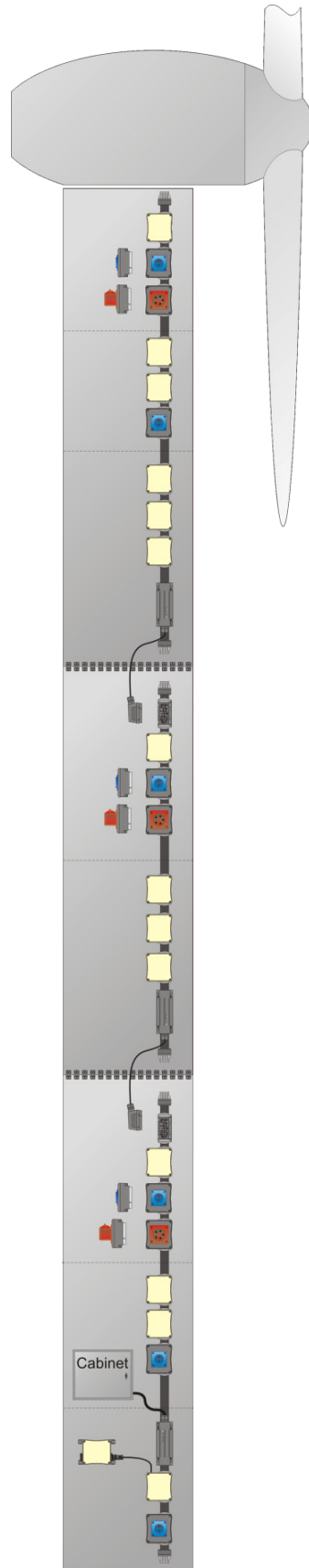

Example of a *podis* system configuration for the tower of a wind energy plant.

3 podis[®] CON flat cable

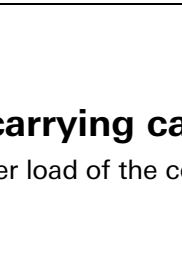
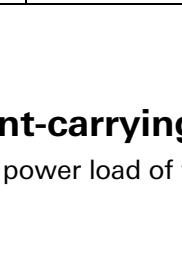
Item No.	Image	Description
00.709.0504.1		Flat cable EVA 7G4 BLACK - VDE Flat cable 7 x 4 mm ² EVA, finely stranded, numbered cores, external dimensions of approx. 35 x 6 mm, weight approx. 440 g/m, 450/750V in accordance with VDE, free of halogen and silicone, resistant against oils and acids, low fire load, black sheath
00.729.0504.1		Flat cable XLPE 7G4 SCHWARZ - UL Flat cable 7 x 4 mm ² XLPE, finely stranded, numbered cores, external dimensions of approx. 35 x 6 mm, 600 V in accordance with UL, UL 1277, free of halogen, low smoke, black sheath.

3.1 Current-carrying capacity of flat cables and points of contact

The maximum power load of the conductors refers to free routing of the cables in the open (>10 mm).

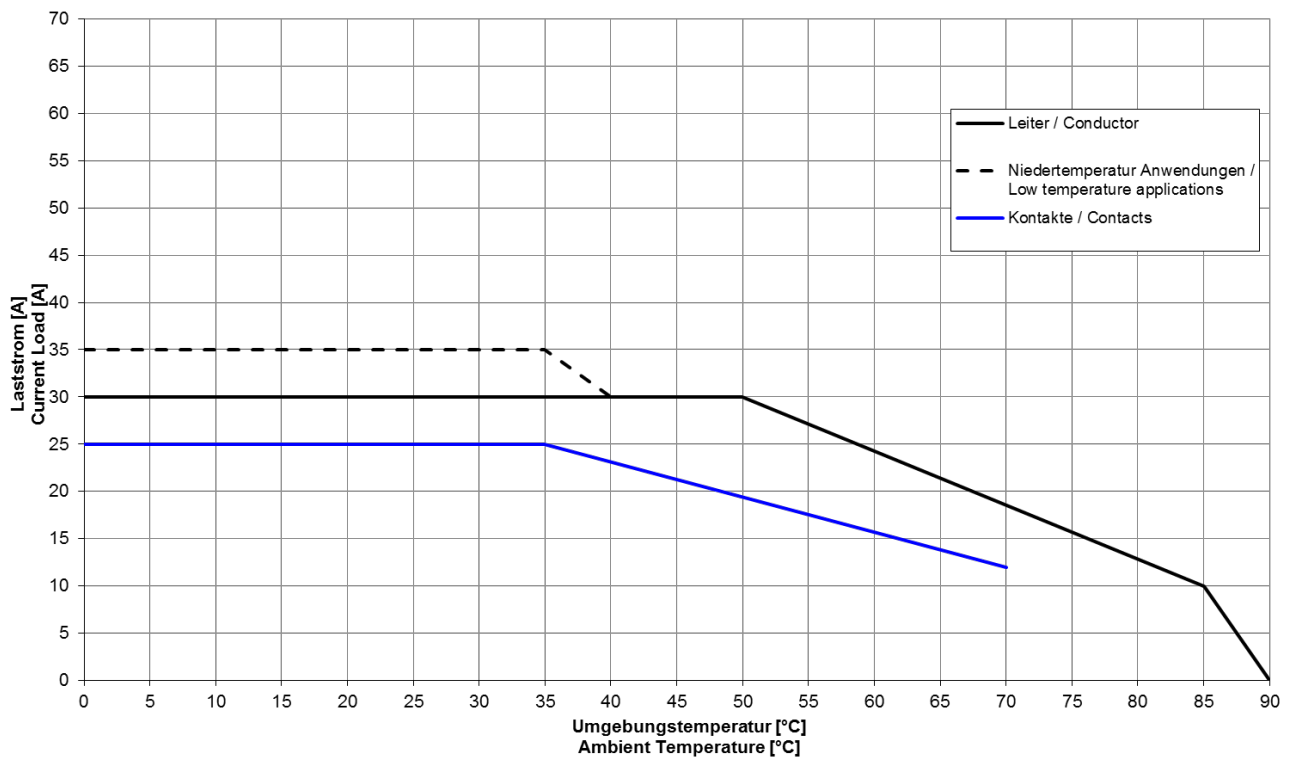

Diagram 1: Maximum permissible power load per conductor and contact for load currents applied to L1, L2 and L3, for flat cable EVA 7G4 (00.709.0504.1) and flat cable XLPE (00.729.0504.1) as fed entirely by plug FCS 4 7 ST SA SO0 (75.015.0151.0) and flat cable outlet FCS 4 7 SI BU SW FM (99.800.4866.1).

3 podis CON flat cable

Table 2: Current-carrying capacity of *podis* CON flat cable EVA 7G4 mm² (00.709.0504.1)

Loaded cores	In the open d > 10 mm			Loose on wall or floor			Cable duct		
	3	5	6	3	5	6	3	5	6
Ta [°C]	Max. cross current			Max. cross current			Max. cross current		
20	40	35	35	40	32	32	35	30	25
25	40	35	35	35	32	30	35	30	25
30	40	35	32	35	30	25	32	25	25
35	35	32	30	32	25	25	30	25	25
40	35	30	30	30	25	25	25	20	20
45	32	30	30	25	20	20	25	20	20
50	30	30	30	25	20	20	20	20	16

3.2 Notes on routing of flat cables

The flat cable is convenient and easy to handle and install. Some rules apply to the installation and routing, which are described in the following.

General instructions and precautionary measures

The *podis* flat cable is operated in grids with grounded feeds (TN-S networks). A floating installation of *podis* systems is not permitted.

CAUTION

- The flat cable may only be commissioned if it is in a faultless condition and does not exhibit any damage to or openings of the sheath.
- Unused connections, outlets or devices on the flat cable must be sealed off using the corresponding measures (lids, blind plugs, etc.). It is not permitted to work on or operate the flat cable with open connections, outlets or devices.
- When conducting any working operations on the flat cable (assembly, maintenance, installation, etc.) the power must be turned off.
- The flat cable must always be closed off using the suitable end caps (see ordering instructions) due to the required air gaps and creepage distances. It is not permitted to operate the flat cable with open ends or using other sealing solutions than the end caps prescribed herein.

NOTE

Openings in the sheath caused by the insulation-piercing termination must be sealed using the sealing collar (see ordering instructions).

Monitoring and safety devices

Depending on the field of application, different components and protective measures are required to complete a system or installation. The type of components and the level of obligation associated with these protective measures depends on which VDE guideline affects your system or installation. Please take note of Section 1 in this regard as well.

The assignment of safety guards to protect from short-circuits of cables and lines of the main or auxiliary circuits outside of switchgear combinations must be conducted under consideration of the loop impedance. DIN VDE 0100 Part 430 is to be applied in this regard.

The flat cable must be protected against overloads and short-circuits using a three-phase 16A (I_{nominal}) circuit breaker with tripping characteristic class C. The tripping current is between 8 and 10 I_{rated} in this case (EN 60898, DIN VDE 0641 Part 11 and IEC 898). The auxiliary circuit must be protected by a single-phase 16 A (I_{rated}) circuit breaker with tripping characteristic class C. Emergency stop devices (in accordance with IEC 204, complies with DIN VDE 113) must be available. Their functioning may not be impaired in any way.

The feed must be grounded (TN-S network). The plant into which the **podis** systems are to be integrated should be connected to the protective ground (neutral point of the mains transformer). If this is not the case, every consumer connected to the **podis** flat cable must be separately connected to the neutral point of the mains transformer through a protective conductor. The diameter of the protective conductor must be at least 4 mm². The protective conductor may not be looped through the consumers. Effective lightning protection measures must be fitted to the plant in order to prevent damage to electronic devices.

The safe electric separation between main and auxiliary circuits is required for the motor starters. The main and auxiliary circuits are constructively separated in the **podis** system in a safe and secure manner. When connecting motor/contactors combinations made by third party manufacturers, make sure that electric separation is guaranteed for these devices (separation voltage of at least 2.5 kV AC).

Regarding the 24 V or 50 V supply, make sure that lightning protection measures are fitted and the low voltage supply is separated in an electrically safe manner.

Routing instructions

Assembly	EVA 7x4 mm ² (00.709.0504.1)	XLPE 7 x 4 mm ² (00.729.0504.1)
Bending radius	> 18 mm	≥100 mm
Assembly temperature	-5 °C...+50°C	+5 °C...+50°C
Routing type	Cable duct, platform with cable clamps (see "Cable collar" Section)	Cable duct, platform with cable clamps (see "Cable collar" Section)
Protection		
380V supply	Three-phase 16A circuit breaker, tripping characteristics class C	Three-phase 16A circuit breaker, tripping characteristics class C
24 V supply	Single-phase 16A circuit breaker, tripping characteristics class C	Single-phase 16A circuit breaker, tripping characteristics class C

⚠ CAUTION
The flat cables are not non-trailing cables.

When routing the flat cables inside cable ducts, you must consider the derating according to VDE 0660 Part 507 and the maximum ambient temperature of 50°C. Please also consider the following diagram regarding the derating.

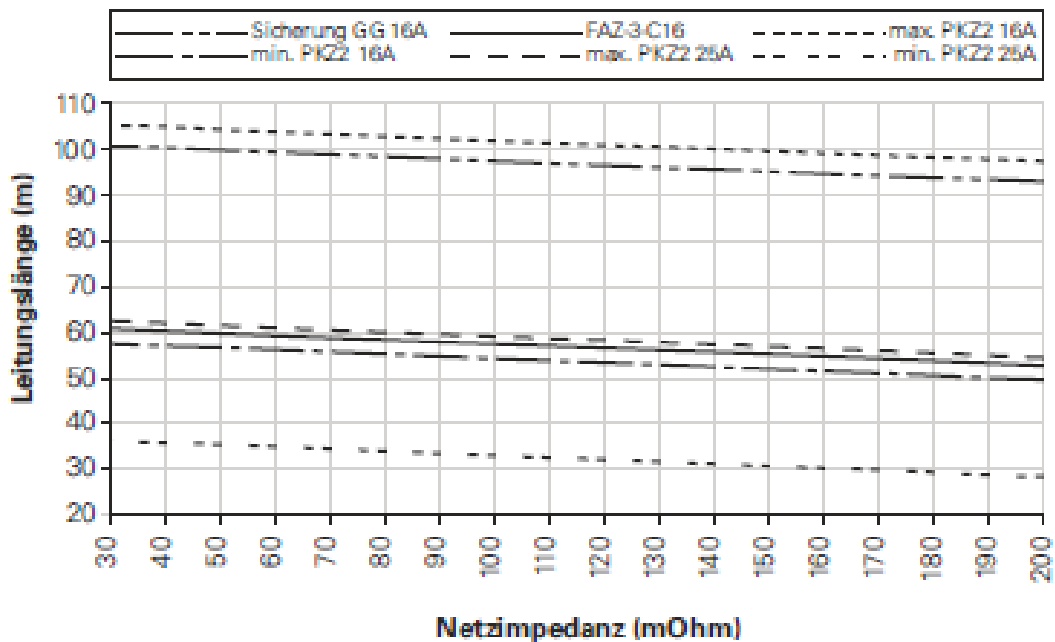

3 podis CON flat cable

Mounting and routing of flat cables with cable clamps

The cable clamps (see ordering instructions) are fitted to solid subsurfaces by means of screw fitting. The flat cable is suspended from the mounted cable clamps (see drawing, variant A).

To secure the flat cable against being pulled out, mount two cable clamps immediately next to one another so that they are put up on the opposing sides of the flat cable (see drawing, variant B).

This type of mounting can also be applied for the vertical routing of flat cables. However, offset cable clamps with alternating stops are also sufficient in this case (see drawing, variant C).

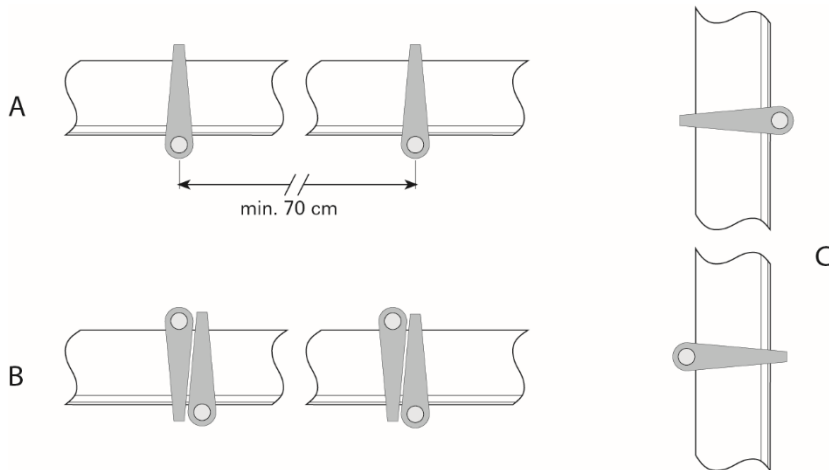

3.3 Cutting flat cables to length

In order to cut the *podis* CON flat cables to length, the cables are separated by a single cut with a pair of cable shears.

Required tools:



Figure: Cable shears (95.300.0300.0)

Cut the flat cable to length as desired using the cable shears (95.300.0300.0). Ensure a clean, square cut. Avoid fraying of the copper cores.

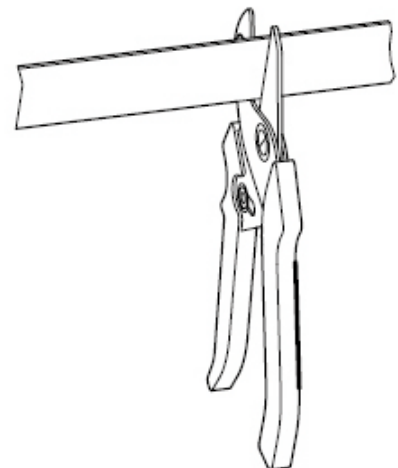

Figure: Cutting flat cable to length

3.4 Stripping of flat cables

The *podis* CON flat cable has to be stripped for some applications. Required for this purpose:

- Assembly of flat cable end caps (Z5.562.7553.1)
- Connection to distributor module (75.010.0053.1)

Required tools:



Figure: Stripping pliers (95.350.0300.0)

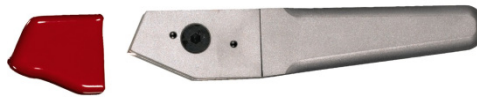
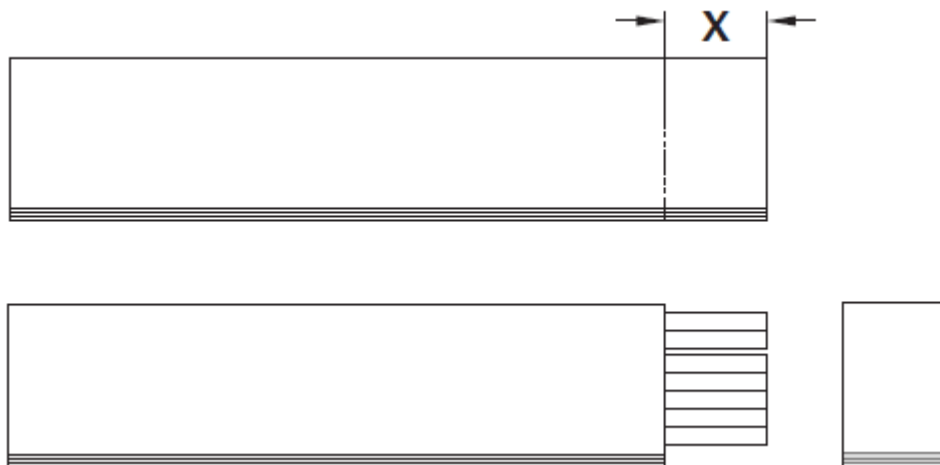

Figure: Stripping knife (95.350.0700.0)

Procedure:

1. Cut the cable to the desired length.
2. Strip the flat cable in accordance with the following table.



Stripping lengths (X mm)

Cable end cap	19 mm
Distributor module	50 mm
Terminal block inside switchgear cabinet	> 50 mm (depending on specific connecting conditions)

3 podis CON flat cable

Stripping of flat cable for attachment of cable end cap

We recommend use of the stripping pliers (95.350.0300.0) for stripping the **EVA 7 x 4 mm²** (00.709.0504.1) as well as **XLPE 7 x 4 mm²** (00.729.0504.1) flat cables. These are equipped with a cable stop that is specially designed for the flat cables in question and thereby allow a clean stripping of the cables. The end of the flat cable is placed into the stripping pliers and the sheath is cut by a powerful press. Keep the pliers closed and lock them using the yellow slider (slide in the direction of the grip until it meets the stop). Slight tilting motions cause the sheath to be separated and then safely stripped.

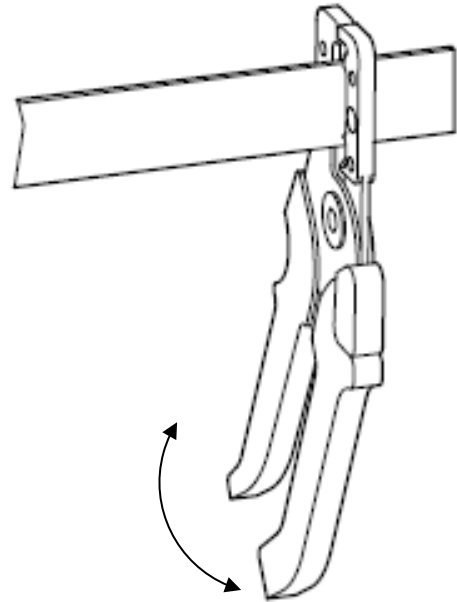

CAUTION

Significant tilting motions can cause the insulation of the conductors to be cut. Only tilt the cable slightly in the direction of the stripping pliers.

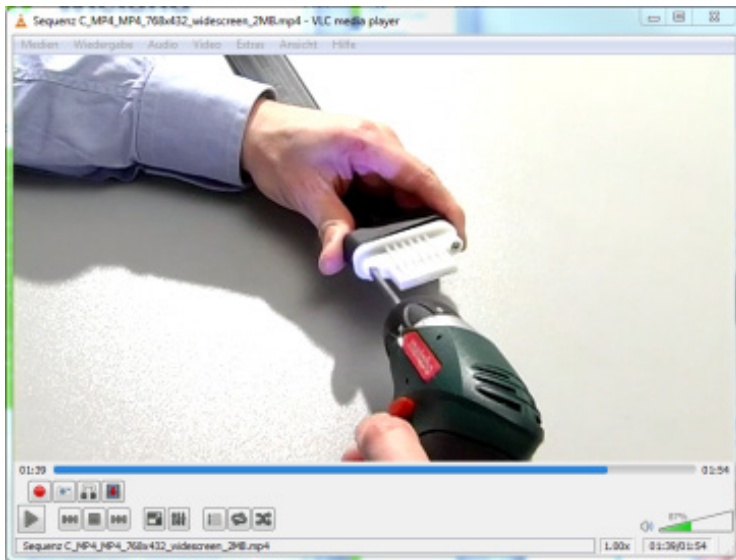

A training video regarding stripping of the cables and attachment of the cable end cap is available here: <https://www.youtube.com/watch?v=oLoFVR-LJ-w>

Stripping of flat cables for connection to the distributor module or terminal strips

Scratch the sheath of the cable on the front and rear sides of the flat cable in the longitudinal and transverse directions as shown in the following images. A standard cable stripping knife suffices for this purpose. Do not scratch deeper into the rubber sheath than a maximum of 0.7 mm in order to avoid damage to the insulation.

When using the stripping knife (95.350.0700.0), the blade protrudes by exactly 0.7 mm in order to prevent any damage to the insulation. The stripping knife is supplied with a set of instructions.



Knife 95.350.0700.0 and combination pliers



Scratching: first transverse, then longitudinal

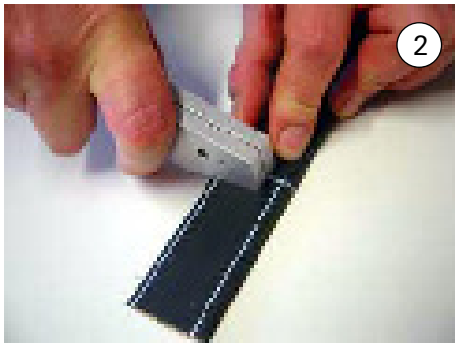

Scratch the flat cable as follows:
1x all around in the transverse direction and then 2x in the longitudinal direction on both sides
The longitudinal cut should end shortly before the transverse cut in order to prevent tearing

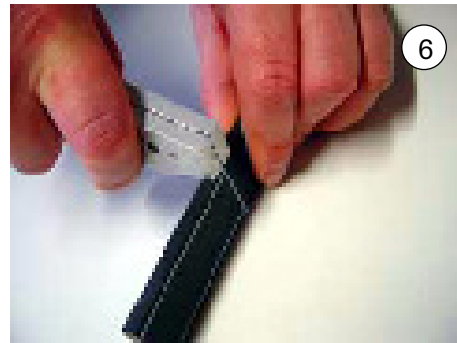

Scratching on the edges.



After scratching, tear open the edges from the front using a pair of pliers.

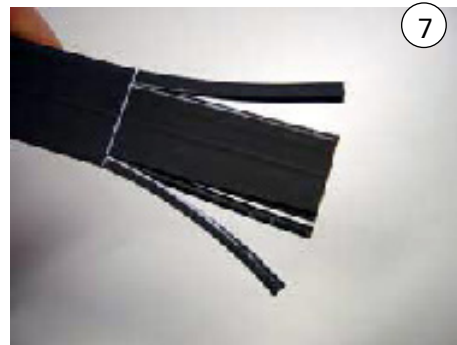

Pull off the sheath on the torn edges



Tear the cable cleanly from below along the transverse scratch.

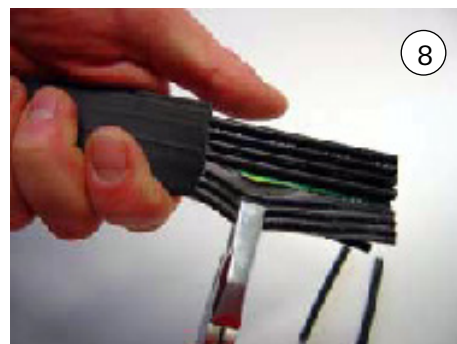

Expose all conductors

3 podis CON flat cable

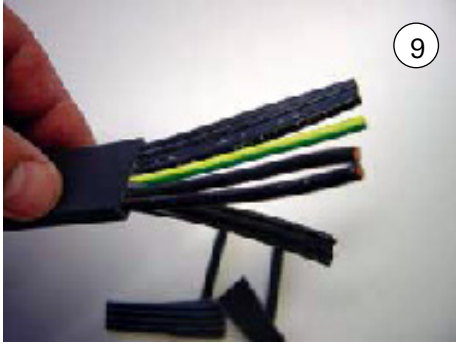

Pull off the web with the remaining sheath residue



3.5 Termination of the flat cable

⚠ CAUTION

Due to the required air gaps and creepage distances, *podis*[®] CON flat cables must always be terminated by end caps on both ends.

After the flat cable has been routed, all free cable ends must be safely terminated and sealed in accordance with IP65. Use the cable end pieces (Z5.562.7553.1) for this purpose. They are composed of a shorter part (cover) and a longer part, which contains the screws, the seal and the insulation ducts. The following images illustrate the termination of the flat cable.

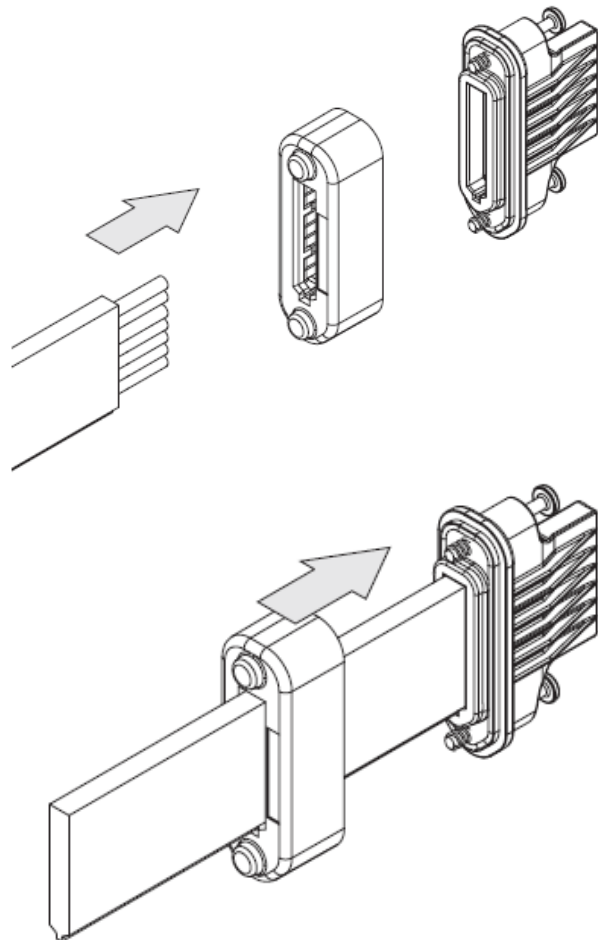

Route the stripped end of the flat cable into the end cap (the openings in the end cap are coded in accordance with the cable outline)

Tighten both clamping screws.

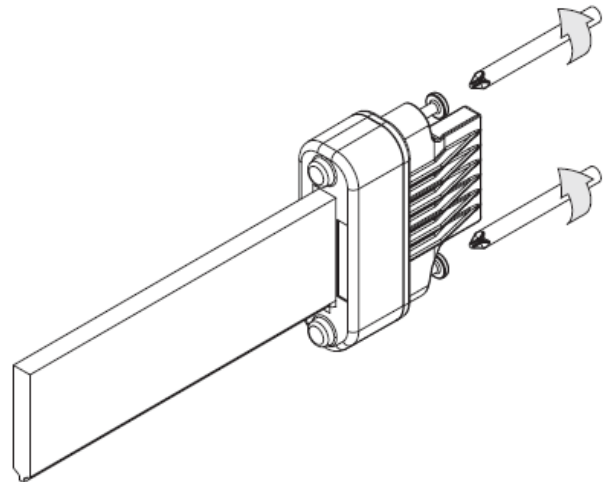

Note: A training video regarding stripping of the cables and attachment of the cable end cap is available here:

<https://www.youtube.com/watch?v=oLoFVR-LJ-w>

 CAUTION
<p>The flat cable is protected against polarity reversal via coding. One edge of the flat cable is V-shaped. The cable receptacles in all system components (flat cable outlets, cable end caps) are shaped correspondingly. The flat cable is inserted in such a manner that the V-shaped side is opposed to the hinge of the opened cable receptacle.</p>

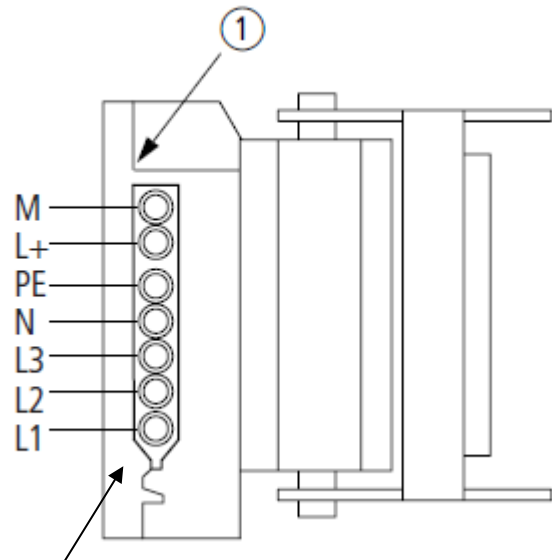

Coding/polarity reversal protection

3.6 Making the connection

The modules for power feed and tap can be installed at any desired point of the flat cable. The conductors of the flat cable remain uninterrupted. The connection is made using contact screws.

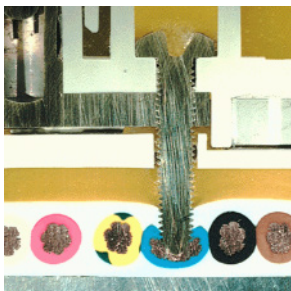

Microsection of a contact point, penetration of the sheath and insulation, contact with the conductor through the contact screw.

3 podis CON flat cable

Conductor assignment

The individual conductors of the flat cable can generally be assigned freely apart from PE. In order to guarantee flawless interaction with other *podis*CON components, we recommend the following assignment for the individual cores:

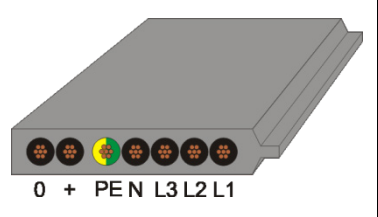
L1: Phase 1 L2: Phase 2 L3: Phase 3 L4: N PE: PE L5: +24 V DC L6: 0 V		<p style="text-align: center;">! DANGER</p> <p>All connecting and removal operations may only be performed on the flat cable in an unpowered state!</p>
---	---	--



4 Rapid assembly using basket trays

The connection module and flat cable outlet are fitted with a rapid assembly panel on the rear side. The rapid assembly panel simplifies the attachment of components inside basket trays. The components are firmly connected to the basket tray by bending the clamping loops. If there are large gaps between the components, the flat cable must be additionally fixated using cable ties.

The assembly panels are suitable for grids with mesh sizes of 100 mm in the longitudinal direction of the basket tray.

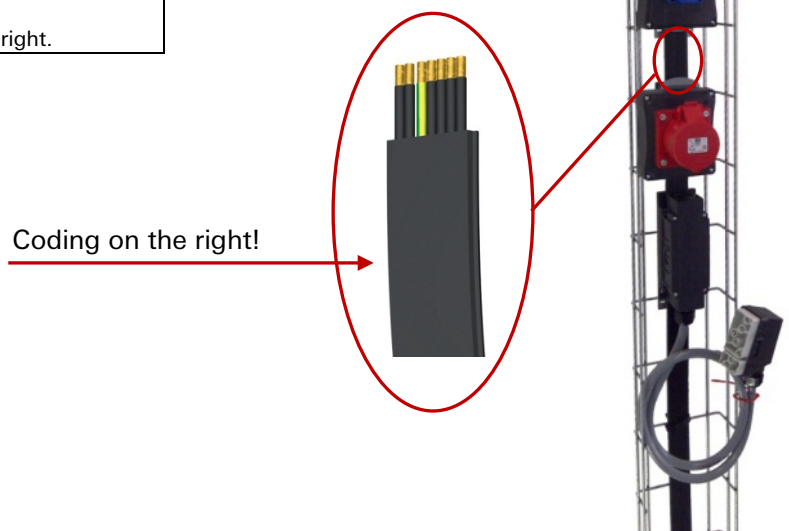



 CAUTION
<ul style="list-style-type: none"> • Ensure the correct mounting position of the components! • For vertical installations, start routing the components from the top. • The coding of the flat cable must be located on the right.



Item No.	Image	Description
99.801.4866.1		Connecting module FCS 4 7 SI FK FM with rapid assembly panel for mounting inside basket trays; 7-pin, 20 A; 277/480 V 4 kV/3 (VDE); 600 V (UL, CSA); protection class IP65; insulation-piercing termination; connection of 1.5...6 mm ² finely stranded/single-wire through spring terminals.
99.801.4866.1		Flat cable outlet FCS 4 7 SI BU FM with rapid assembly panel for basket trays; 7-pin, 20 A; 277/480 V 4 kV/3 (VDE); 600 V (UL, CSA); socket with plastic locking bolt; protection class IP65, plugged or with protective lid 07.409.7256.0.

4 Rapid assembly using basket trays

4.1 Example using flat cable outlet

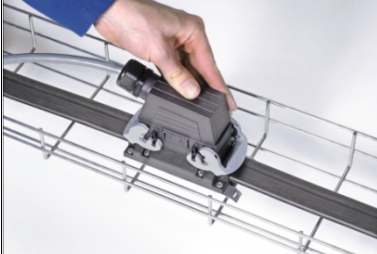
<p>Attachment of component with assembly panel.</p>	
<p>Bending of the clamping loops on the assembly panel.</p>	
<p>Bending of the flat cable and closing of the flat cable outlet.</p>	
<p>Termination of the outlet with the flat cable by screwing in the contact screws.</p>	
<p>Connection of the plug or functional module, lock and – done!</p>	

CAUTION

- The contact screws must be screwed in until they meet the stop! The maximum tightening torque may not exceed 1 Nm.
- The use of an electric or pneumatic torque driver is recommended. Phillips-head screwdriver, size 1, shaft length at least 45 mm. Matching screwdriver blade in accordance with DIN 3128, PH 1, Item No. 06.502.5200.0 The minimum connection temperature for the EVA 7G4 mm² flat cable is -5°C. for the XLPE 7G4 flat cable, the minimum assembly temperature is + 5 °C.



A training video showing the mounting of the connection components, the insertion of the flat cable and the termination of conductors is available at: <https://www.youtube.com/watch?v=LZKgNO11-kA>

5 Feeding into a power bus segment and power tapping

There are multiple ways to feed into a power bus segment:

- Directly from the switchgear cabinet
- Through the distributor module
- Through the 7-pin connection module

5.1 Feed directly from the switchgear cabinet

The flat cable is routed into the switchgear cabinet using the flat cable bushing (Z5.563.6553.1) and connected there directly.

Advantages: No feeding via round conductor and feeding module necessary

Disadvantages: Poor distribution of voltage and current on the power bus (high currents close to switchgear cabinet, high voltage away from the switchgear cabinet). Long distances between switchgear cabinet and first consumer in the field wastes unnecessary quantities of flat cable

Insertion, retaining and connection of flat cable inside switchgear cabinet

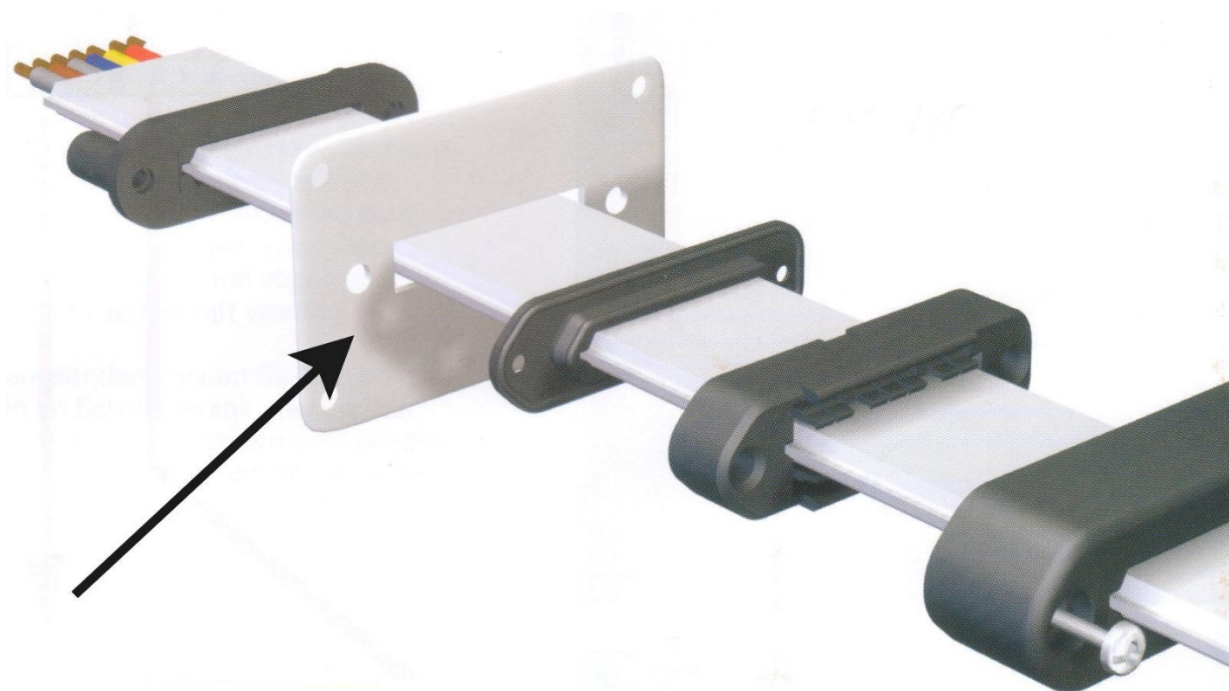

Connection of flat cable with flat cable bushing (black) and adapter plate (white). The adapter plate Z5.563.7553.0 can optionally be used, for example for large housing openings

5.2 Feeding through distributor module

A round conductor is routed into the field from the switchgear cabinet. This conductor is connected to the flat cable through the distributor module (FCS 4 7 SA SA SW, 75.010.0053.1).

Advantages:

- Central feed of up to 32 A possible
- Simultaneous branching of up to 3 cable connections

Disadvantages:

- Comparatively high assembly efforts

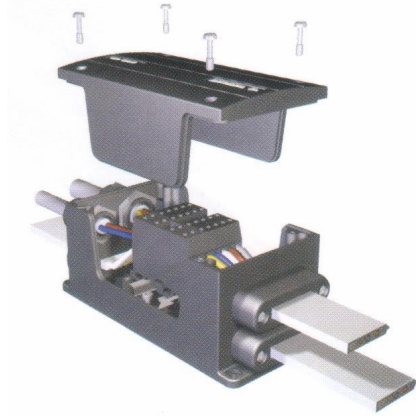

The following conductor cross-sections can be connected:

- 0.5 - 4 mm² single-wire or with wire end ferrule
- 0.5 - 6 mm² single-wire

5.3 Feeding through 7-pin connection module

A round conductor is routed into the field from the switchgear cabinet. This conductor is connected to the flat cable through the 7-pin connection module (FCS 4 7 SI FK, 75.018.0051.2).

Advantages:

- Central feed of up to 25 A possible (derating)
- Uninterrupted feed through insulation-piercing termination - fast and secure

Disadvantages:

- Maximum feeding current of 25 A
- The connection module has branching points for round conductor fittings on all sides.
- These have to be ordered as extra accessories depending on the application.

NOTE

Feeding through the connection module is the most cost-effective solution for the power feed (requirement for this application: the supplied current must be sufficient for the intended application of the power bus segment).

5 Feeding into a power bus segment and power tapping

Limit values of current-carrying capacity [A] of *podis*[®]CON connection components on the flat cable EVA 7 x 4 mm², valid for connection module (75.018.0051.2) and flat cable outlet, pluggable (75.015.5153.1):

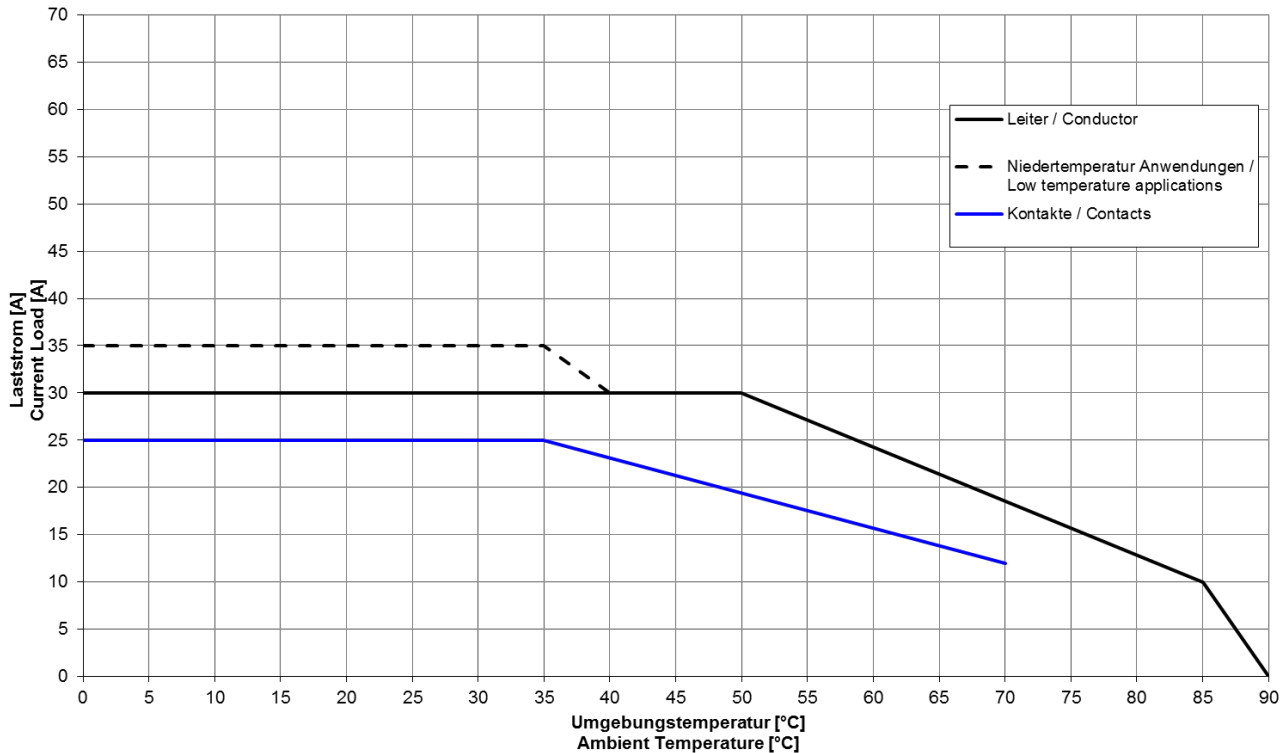

Example for feeding

Assuming a maximum ambient temperature of 30°C, it is, for example, possible to feed up to 35 A for the cable section (400 VAC, contact points 1-3) and 20 A for the auxiliary conductors (24 VDC, contact points 5 and 6). This example assumes a symmetrical load (no current on neutral conductors or contact point 4).

Mounting of connection and tapping modules

Connection modules and flat cable outlets can be placed on both sides of the flat cable due to its symmetrical properties. The flat cable is inserted with the correct coding, the top section is closed and then screwed into place. The mounting is demonstrated by means of a fixed connection module. The assembly of a pluggable outlet is handled in the same manner.

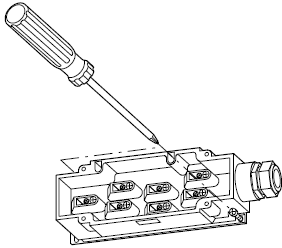
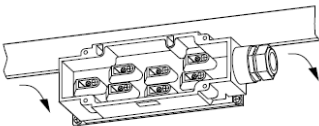
<p>Screw the module to the base using suitable screws, for example M4. Only use the slotted holes intended for this purpose.</p>	
<p>Open up the top section and place the flat cable into it.</p>	

5 Mounting of flat cable inside switchgear cabinet

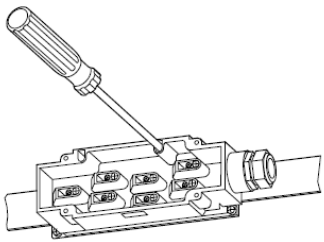
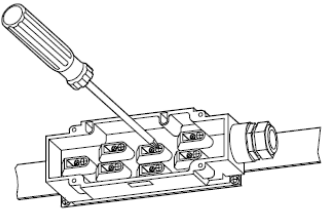
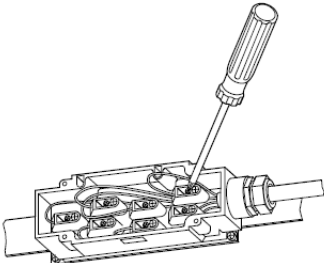
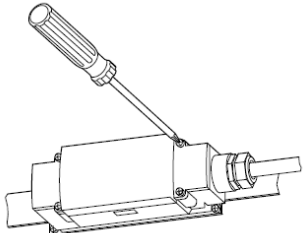
<p>Close the top section again and screw it shut. This seals the contact points in accordance with IP 65.</p>	
<p>Screw all seven contact screws into place. Contact is thereby made with the conductors of the flat cable.</p>	
<p>Now connect the connection cable. The individual conductors are inserted into the spring clamps. In accordance with VDE 0611, all types of conductors (solid, stranded or finely stranded) can be connected.</p>	
<p>Screw the housing cover into place as the final step.</p>	

CAUTION

- The contact screws must be screwed in until they meet the stop! The maximum tightening torque may not exceed 1 Nm.
- The use of an electric or pneumatic torque driver is recommended. Phillips-head screwdriver, size 1, shaft length at least 45 mm. Matching screwdriver blade in accordance with DIN 3128, PH 1, Item No. 06.502.5200.0
- The minimum connection temperature for the EVA 7 x 4 mm² flat cable is -5°C. for the XLPE 7G4 flat cable, the minimum assembly temperature is + 5° C.



A training video detailing the connection of a round conductor to a connection module is available at:
<https://www.youtube.com/watch?v=-2cPjqt4JM8>

5 Feeding into a power bus segment and power tapping



5.4 Connection modules

The permanently connected *podis*[®]CON connection module is used for both feeding into the power bus and as a tap for supplying permanently connected devices. Furthermore, the connection module is used for connection of two power bus segments. The module is electrically connected to the flat cable through insulation-piercing termination. All 7 cores are connected through so that all voltage levels are available. The coding of the cable avoids twisting.

The permanent connection of the connection module and the flat cable via the inserted seal also provides strain relief.

⚠ DANGER

- Contact between the connection module and the cable must be established in an unpowered state.

Item No.	Image	Description
75.018.0051.2		Connecting module FCS 4 7 SI FK Connection module, 7-pin, 20A; 277/480V 4kV/3 (VDE); protection class IP65; insulation-piercing termination, connection of 1.5...6 mm ² finely stranded/solid through spring terminals; 4 predetermined breaking points (2xM20, 2xM25); black.
99.801.4866.1		Connecting module FCS 4 7 SI FK FM with rapid assembly panel for mounting inside basket trays; 7-pin, 20 A; 277/480 V 4 kV/3 (VDE); 600 V (UL, CSA); protection class IP65; insulation-piercing termination; connection of 1.5...6 mm ² finely stranded/single-wire through spring terminals.
75.010.0053.1		Distributor module FCS 4 7 SA SA SW Distributor module FCS 4 7 SA SA; 7-pin 32 A; 7 x 32 A (VDE) and/or 7 x 30 A (UL/CSA); 500 V 6 kV/3 (VDE) and/or 600 V (UL/CSA) with double level terminal strips, 5 predetermined breaking points, 3 x <i>podis</i> [®] -flat cable, 2 x round conductors M20/M25; black.

The distributor module 75.010.0053.1 is used for feeding into the flat cable, but also for distributing the power to multiple flat cables. The distributor module is equipped with connection options for three flat cables and one round conductor. Two round conductors can be routed through the housing, for example for one 5-core 400 V cable through cable gland M25 and one 2-core 24V cable through cable gland M20. Flat cables and round conductors are connected to the distributor module with screw terminals. The cable bushing Z5.563.6553.1, see accessories, is available for routing the flat cable to the distributor module.



5.5 Flat cable outlet, pluggable (power tap)

The *podis*[®]CON flat cable outlet is the connection interface (power tap) on the power bus for supplying the pluggable devices. The flat cable outlet is electrically connected to the flat cable through insulation-piercing termination. All 7 cores are connected through so that all voltage levels are available. This allows for the insertion of motor starters, CEE sockets, grounded sockets and LED lights on a socket. Functional modules and plugs can be connected in a powered state. The coding of the cable and connector makes twisting of the flat cable outlet impossible. The permanent connection of the connection module and the flat cable via the inserted seal also provides strain relief.

⚠ DANGER

- Contact between the connection module and the cable must be established in an unpowered state.

5 Mounting of flat cable inside switchgear cabinet

Item No.	Image	Description
75.015.5153.1		Flat cable outlet FCS 4 7 SI BU SW Flat cable outlet, pluggable FCS 4 7 SI BU; 7-pin, 20 A; 277/480V 4kV/3 (VDE); 600V (UL, CSA); socket with plastic locking bolt; protection class IP65, plugged or with protective lid 07.409.7256.0; black
99.800.4866.1		Flat cable outlet FCS 4 7 SI BU FM pluggable with rapid assembly panel for basket trays; 7-pin, 20 A; 277/480 V 4 kV/3 (VDE); 600 V (UL, CSA); socket with plastic locking bolt; protection class IP65, plugged or with protective lid 07.409.7256.0.

Protective lid

If a tap of the pluggable outlet (75.015.5153.1; 99.800.4866.1) is no longer required, it can be closed using a protective lid. When using the protective lid, protection class IP65 is ensured.

Item No.	Image	Description
07.409.7256.0		Protective lid Protective lid without locking bolt, without seal, size 16

6 Attachment of pluggable devices and functional modules

Plugs and various functional modules can be attached to the *podis*[°] CON flat cable outlet and secured using two locking bolts.

6.1 Connector for round conductor connection

Electrical devices can easily be connected to the power bus using a round conductor and the *podis*[°] CON plug. The *podis*[°] CON plug is suitable for supplying devices away from the power bus in an easily replaceable manner.



Item No.	Image	Description
75.015.0151.0		Complete plug FCS 4 7 ST SA S00 <i>podis</i> [°] CON plug FCS 4.0 7 ST SA; 7-pin, pins, 20 A, 277/480 V 4kV/3 (VDE); 600 V (UL, CSA); with M25 screw fitting for 9-16 mm round conductors; screw connection 4.0 mm ² ; protection class IP65; black.

6.2 Connection of multiple flat cable sections

The connection of a flat cable and an additional flat cable section can be made using the *podis*[°] CON connection module FCS 4 7SI FK and the *podis*[°] CON connector FCS 4.0 7 ST SA.



If the flat cable sections are to be connected in a pluggable manner, a flat cable outlet FCS 4 7 SI BU SW (75.015.5153.1) must be fitted to the feeding flat cable. The connection module of the connecting line 83.302.x025.1 is mounted on the receiving flat cable section. The plug can now be connected to the feeding flat cable section.

If the flat cable sections are to be connected to one another permanently, the 83.303.x039.1 connecting line should be used. The connection modules with premounted round conductors are mounted on the flat cable sections to be connected and terminated.

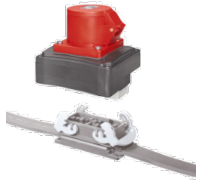

Item No.	Image	Description
83.302.x025.1		Connecting line FCS 2,5 7 STSA SIFK <i>podis</i> [°] CON connecting line FCS 2,5 7 STSA SIFK; assembled plug with 7 x 2.5 mm ² round conductor, connection module; cable length x in meters; black.
83.303.x039.1		Connecting line FCS 4 7 SIFK SIFK <i>podis</i> [°] CON connecting line FCS 4 7 SIFK SIFK; assembled connection module with 7x4mm ² round conductor, connection module; cable length x in meters; black

6.3 Socket module

Additional electric consumers can be connected to the power bus and/or for maintenance or servicing purposes quite easily using *podis*[®] CON socket modules. These socket modules are attached to the flat cable outlet FCS 4 7 SI BU SW and securely mounted using two locking bolts.

Item No.	Image	Description
83.315.0001.1		<i>podis</i>[®] CON socket FCS-CEE7/4 230V16A3P <i>podis</i> [®] CON plug with socket (blue); German standard; straight installation; Schuko plug and/or CEE 7/4, 230 V, 16 A, 3-pin, IP54; connected conductors: L1 - 1; N - 4; PE - PE.
83.315.0002.1		<i>podis</i>[®] CON socket FCS-CEE6H 400V16A5P <i>podis</i> [®] CON plug with CEE socket (red); straight installation; 220/380 V AC; 240/415 V AC; 16 A-6 h, 3P+N+PE; 50/60 Hz; IP44; connected conductors: L1 - 1; L2 - 2; L3 - 3; N - 4; PE - PE.
83.315.0004.1		<i>podis</i>[®] CON socket PLUG FCS NEMA 5-20 GFCI 2P <i>podis</i> [®] CON socket FCS-NEMA 5-20 GFCI 120V20A3P <i>podis</i> [®] CON plug-in module with two NEMA 5-20 sockets; secured by GFCI; 120 V, 20 A, 3-pin; protection class NEMA 3 (humidor), connected conductors L1 - 1, N - 4.
83.315.0005.1		<i>podis</i>[®] CON socket PLUG FCS CPCS 230V10A3P <i>podis</i> [®] CON socket; CPCS socket (multiple plug adapter); 250 V AC, 10 A, 3-pin; IP44; connected conductors L1 - 1, N - 4, PE - PE

6.4 Drive control systems *podis*[®] MOT, *podis*[®] MCU

Item No.	Image	Description
83.210.xxxx.x 83.214.xxxx.x 83.252.xxxx.x		The <i>podis</i> [®] MOT field distributors provide the remotely switched drives with power, and also connect them to the 24V auxiliary voltage and the fieldbus. <i>podis</i> [®] MOT are used to control SEW MOVIMOT and MOVI-SWITCH drive units.
83.222.0009.5 83.223.0009.5		As part of a particularly compact housing, the <i>podis</i> [®] MCU and <i>podis</i> [®] MSS motor starters combine the function of the electronic motor starter with AS-i controls as well as the integration of up to three sensors. They are used in applications where three-phase current motors of up to 1.5 kW have to be started, optionally in one or two directions of rotation. <i>podis</i> [®] MCU - Direct starter/reversing starter <i>podis</i> [®] MSS - Soft starter

6 Attachment of pluggable devices and functional modules

6.5 Maintenance switch *podis*[®] SWITCH

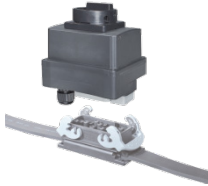
Item No.	Image	Description
83.315.0001.1		<i>podis</i>[®]SWITCH pluggable outlet with maintenance switch; 400V AC, 3-phase with additional auxiliary contact; switching position signal on M12 plug; rated uninterrupted current $I_u = 25A$; switching capacity in accordance with AC23A/B = 11kW/400V; in accordance with AC3 = 7.5kW/400V

6.6 LED lights *podis*[®] LED

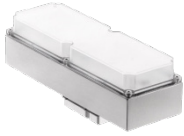
Item No.	Image	Description
83.240.0010.0 83.241.0030.0		<i>podis</i>[®]LED Energy-saving LED lights pluggable on flat cable outlets (Item No. 75.015.5153.1); for rough industrial environments (for example wind energy plants) and as emergency illumination in accordance with DIN 60598-2-22; typ. 360 lm; 15...32 V DC; 5 W; daylight white, 6500 K
83.240.0110.0 83.241.0110.0		<i>podis</i>[®]LED Energy-saving LED lights pluggable on flat cable outlets (Item No. 75.015.5153.1); for rough industrial environments (for example wind energy plants, shafts, machines), workplaces and as emergency illumination in accordance with DIN 60598-2-22; can be installed in any position; typ. 2000 lm

For more products, visit www.wieland-electric.com

7 Accessories

Sealing sleeve

If a connection module has to be removed from the flat cable, a sealing sleeve is used to seal off the contact point. Usage of the sealing sleeve ensures compliance with protective class IP65.

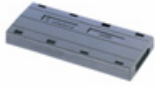
Item No.	Image	Description
Z1.005.6553.1		Sealing sleeve for <i>podis*CON</i> flat cable to seal off contacts. Protection class IP65; black.

Protective lid

If a tap of the pluggable outlet (75.015.5153.1; 99.800.4866.1) is no longer required, it can be closed using a protective lid. When using the protective lid, protection class IP65 is ensured.

Required modules:

Item No.	Image	Description
07.409.7256.0		Protective lid Protective lid without locking bolt, without seal, size 16

Cable bushing

In order to terminate the RST round conductor bus line, the socket on the outlet side is closed up with an end cap on the last LED light. When using the end cap, protection class IP65 is ensured.

Item No.	Image	Description
Z5.563.6553.1		Housing bushing for <i>podis*CON</i> 7x2.5 mm ² and 7x4 mm ² flat cables; protection class IP65; black

Cable glands

Item No.	Image	Description
Z5.507.1353.1		Cable gland M20x1.5, black
Z5.505.0653.1		Cable gland M20x1.5 WITH AS-i insert, black
05.505.0153.1		Locknut M20x1.5 black
Z5.507.1453.1		Cable gland M25x1.5 (for 9-16 mm cable), black
Z5.507.1553.1		Cable gland M25x1.5 (for 13-18 mm cable), black
05.505.0253.1		Locknut M25x1.5, black

7 Accessories

Cable clip

For mounting of podis® flat cables

Item No.	Image	Description
Z5.563.3000.0		Fastening clamp, light gray