

POWERSTAT Variable Transformers of the 146-246 Series are available in single and three phase, manually operated and motor-driven assemblies. 146 Series units operate from 120 volt lines and 246 Series units from 240 volt lines. The rated output for constant current loads is 30 amperes for the 146 Series and 15 amperes for the 246 Series. For constant impedance loads, the maximum rated output current at line voltage is increased to 35 amperes for 146 types and 19 amperes for 246 types. Both Series incorporate POWERKOTE coils for longer life and increased resistance to damage.

POWERSTAT Variable Transformers of the 146-246 Series can be operated at any frequency between 50 and 550 hertz. Figure A shows the reduction in allowable output current when operated at higher than rated frequency. Figure B shows the regulation curves for types of the 146-246 Series operating at full load current. The curves show the voltage drop at any brush setting when full load is applied. For less than full load, the voltage drop is proportional to the load. Driving torque, d-c resistance per coil and maximum core and brush loss when operating under no load are given in the chart ratings. All models can be connected to deliver an increasing output voltage with either clockwise or counterclockwise knob rotation and have standard dials graduated 0-100. The angle of rotation from zero to maximum output voltage is 316°.

All are available with the terminal board enclosed in a metal terminal box. Knockouts in the terminal enclosure permit wiring with cable or conduit. Terminal enclosed models have the letter T in the type number following the series designation. For example: 5M246T. Fused units, prefixed with the letter F, in the 146 Series have 30 ampere fuses and those in the 246 Series have 15 ampere fuses.

Open construction units have the letter U suffix in the type number and the same electrical ratings and coil-to-terminal wiring as their corresponding enclosed construction models. They have no protective screening and the shaft extends from the radiator or brush end of the assembly. Knobs can be placed at the base end for back-of-panel mounting because the shaft is removable.

POWERSTAT Variable Transformers of the 146-246 Series are available in two- and three-gang assemblies in either enclosed or open construction. Most are provided with jumpers in the standard common position that may be moved or removed as desired.



TYPE 146



U TYPES



MOTOR-DRIVEN U TYPES

Two- and three-gang units connected for parallel operation to increase their current-carrying capacity require chokes to insure equal division of load. Order choke T6053 for type 146-2, choke T5000B for type 246-2, choke T6065 for type 146-3 or choke T5579B for type 246-3.

All types in the 146-246 Series are available with motor drives in standard speeds of 5, 15, 30 or 60 seconds for full range travel. Motor-driven units have an M prefix in the type number and the identical electrical ratings of their corresponding manually operated models. The motor is rated for an input of 120 volts, 50/60 hertz single phase with a current requirement of 0.3 ampere. Stand-offs are provided for bench mounting and slotted brackets for against-the-wall mounting. When ordering, motor-driven types should be prefixed with the desired speed in seconds. For example: 5M146.

TYPE†	Approximate Driving Torque		Typical No-Load Loss at 60 Hertz (Watts)	D-C Resistance per Coil* (Ohms)
	Oz-In	KpCm		
146	40-60	2.9-4.3	25	0.2
146-2	80-120	5.8-8.6	50	0.2
146-3	120-180	8.6-13	75	0.2
246	40-60	2.9-4.3	25	0.9
246-2	80-120	5.8-8.6	50	0.9
246-3	120-180	8.6-13	75	0.9

*Measured from start to end of winding.

†Data also applies to types having applicable prefixes and suffixes.

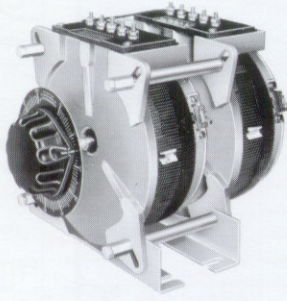

GANGED U TYPES

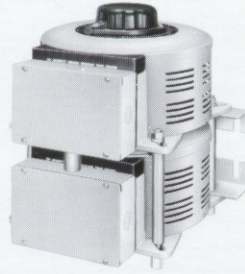

T TYPES



MOTOR-DRIVEN SCREENED TYPES

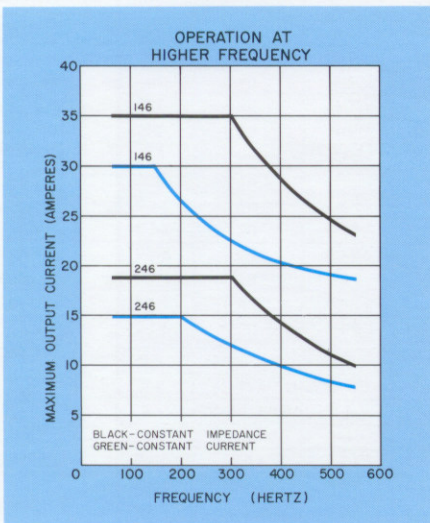

FIGURE A

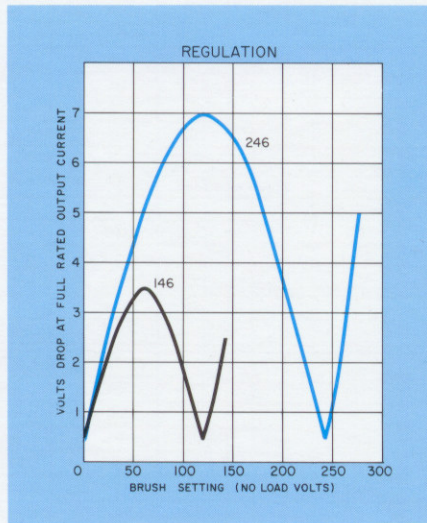
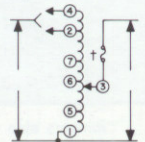

FIGURE B

CONNECTIONS AND RATINGS

TYPE	INPUT		OUTPUT				KNOB ROTATION	TERMINALS				
	VOLTS	HERTZ	VOLTS	CONSTANT CURRENT LOAD		CONSTANT IMPEDANCE LOAD		KNOB ON RADIATOR END		KNOB ON BASE END		
				MAX AMP	MAX KVA	MAX AMP		MAX KVA	INPUT	OUTPUT	INPUT	OUTPUT
146 M146† F146 MF146† 146T M146T† 146U M146U‡	120	50/60	0-120	30	3.6	35	4.2	CW	1-4	1-3	1-4	3-4
0-140			30	4.2	—	—	CW	1-2	1-3	4-5	3-4	
246 M246† F246 MF246† 246T M246T† 246U M246U‡	240	50/60	0-240	15	3.6	19	4.6	CW	1-4	1-3	1-4	3-4
			0-280	15	4.2	—	—	CCW	1-4	3-4	1-4	1-3
	120	50/60	0-280	15*	1.8‡	—	—	CW	1-2	1-3	4-5	3-4
			0-280	15*	1.8‡	—	—	CCW	4-5	3-4	1-2	1-3



146 TYPES DO NOT HAVE TERMINALS 6 OR 7

CONNECTIONS SHOWN ARE FOR CW KNOB ROTATION, KNOB ON RADIATOR END (CCW ROTATION, KNOB ON BASE END)

*Maximum output current in output voltage range up to 150 volts. At higher output voltages output current must be reduced according to rating curve Figure B on page 4.

‡Maximum KVA at maximum output voltage. Maximum KVA at lower output voltages may be calculated from rating curve Figure B on page 4.

†Fuses recommended on all units. 30 ampere fuses supplied internally on F146 types, 15 ampere on F246 types.

‡Motor-driven types use connections for CW rotation, knob on radiator end.

CONNECTIONS AND RATINGS

TYPE	CONNECTION	INPUT		OUTPUT				ROTATION	TERMINALS						
		VOLTS	HERTZ	VOLTS	CONSTANT CURRENT LOAD		CONSTANT IMPEDANCE LOAD		KNOB ON RADIATOR END			KNOB ON BASE END			
					MAX. AMP.	MAX. KVA	MAX. AMP.		MAX. KVA	INPUT	JUMPER »	OUTPUT	INPUT	JUMPER »	OUTPUT
146U-2 M146U-2☆	#1 1-PHASE PARALLEL †	120	50/60	0-120	60	7.2	70	8.4	CW	1-4	1-1, 4-4 †	1-C	1-4	1-1, 4-4 †	4-C
				0-140	60	8.4	—	—	CCW	1-4	1-1, 4-4 †	4-C	1-4	1-1, 4-4 †	1-C
		0-120	60	7.2	70	8.4	CW	1-2	1-1, 2-2 †	1-C	4-5	4-4, 5-5 †	4-C		
	#2 1-PHASE SERIES	240	50/60	0-240	30	7.2	35	8.4	CCW	4-5	4-4, 5-5 †	4-C	1-2	1-1, 2-2 †	1-C
				0-240	30	7.2	35	8.4	CW	4-4	1-1	3-3	1-1	4-4	3-3
				0-280	30	8.4	—	—	CCW	1-1	4-4	3-3	4-4	1-1	3-3
#2 3-PHASE OPEN DELTA	120	50/60	0-120	30	6.2	35	7.3	CW	2-2	1-1	3-3	5-5	4-4	3-3	
			0-120	30	6.2	35	7.3	CCW	5-5	4-4	3-3	2-2	1-1	3-3	
			0-140	30	7.3	—	—	CW	4-1-4	1-1	3-1-3	1-4-1	4-4	3-4-3	
246U-2 M246U-2☆	#1 1-PHASE PARALLEL †	240	50/60	0-240	30	7.2	38	9.1	CW	1-4	1-1, 4-4 †	1-C	1-4	1-1, 4-4 †	4-C
				0-280	30	8.4	—	—	CCW	1-4	1-1, 4-4 †	4-C	1-4	1-1, 4-4 †	1-C
		120	50/60	0-280	30**	3.6 †	—	—	CW	1-2	1-1, 2-2 †	1-C	4-5	4-4, 5-5 †	4-C
				0-280	30**	3.6 †	—	—	CCW	4-5	4-4, 5-5 †	4-C	1-2	1-1, 2-2 †	1-C
				0-280	30**	3.6 †	—	—	CW	1-6	1-1, 6-6 †	1-C	4-7	4-4, 7-7 †	4-C
				0-280	30**	3.6 †	—	—	CCW	4-7	4-4, 7-7 †	4-C	1-6	1-1, 6-6 †	1-C
	#2 1-PHASE SERIES	480	50/60	0-480	15	7.2	19	9.1	CW	4-4	1-1	3-3	1-1	4-4	3-3
				0-480	15	7.2	19	9.1	CCW	1-1	4-4	3-3	4-4	1-1	3-3
		240	50/60	0-560	15	8.4	—	—	CW	2-2	1-1	3-3	5-5	4-4	3-3
				0-560	15	8.4	—	—	CCW	5-5	4-4	3-3	2-2	1-1	3-3
				0-560	15**	3.6 †	—	—	CW	6-6	1-1	3-3	7-7	4-4	3-3
				0-560	15**	3.6 †	—	—	CCW	7-7	4-4	3-3	6-6	1-1	3-3
#2 3-PHASE OPEN DELTA	240	50/60	0-240	15	6.2	19	7.9	CW	4-1-4	1-1	3-1-3	1-4-1	4-4	3-4-3	
			0-240	15	6.2	19	7.9	CCW	1-4-1	4-4	3-4-3	4-1-4	1-1	3-1-3	
	120	50/60	0-280	15	7.3	—	—	CW	2-1-2	1-1	3-1-3	5-4-5	4-4	3-4-3	
			0-280	15	7.3	—	—	CCW	5-4-5	4-4	3-4-3	2-1-2	1-1	3-1-3	
			0-280	15**	3.2 †	—	—	CW	6-1-6	1-1	3-1-3	7-4-7	4-4	3-4-3	
			0-280	15**	3.2 †	—	—	CCW	7-4-7	4-4	3-4-3	6-1-6	1-1	3-1-3	
146U-3 M146U-3☆	#3 1-PHASE PARALLEL*	120	50/60	0-120	90	10.8	105	12.6	CW	1-4	1-1-1, 4-4-4*	1-C	1-4	1-1-1, 4-4-4*	4-C
				0-140	90	12.6	—	—	CCW	1-4	1-1-1, 4-4-4*	4-C	1-4	1-1-1, 4-4-4*	1-C
		240	50/60	0-240	30	12.5	35	14.5	CW	1-2	1-1-1, 2-2-2*	1-C	4-5	4-4-4, 5-5-5*	4-C
	0-240			30	12.5	35	14.5	CCW	4-5	4-4-4, 5-5-5*	4-C	1-2	1-1-1, 2-2-2*	1-C	
	0-280			30	14.5	—	—	CW	4-4-4	1-1-1	3-3-3	1-1-1	4-4-4	3-3-3	
	246U-3 M246U-3☆	#3 1-PHASE PARALLEL*	240	50/60	0-240	45	10.8	57	13.7	CW	1-1-1	4-4-4	3-3-3	4-4-4	1-1-1
0-280					45	12.6	—	—	CCW	1-1-1	4-4-4	3-3-3	4-4-4	1-1-1	3-3-3
120			50/60	0-280	45**	5.5 †	—	—	CW	1-2	1-1-1, 2-2-2*	1-C	4-5	4-4-4, 5-5-5*	4-C
				0-280	45**	5.5 †	—	—	CCW	4-5	4-4-4, 5-5-5*	4-C	1-2	1-1-1, 2-2-2*	1-C
				0-280	45**	5.5 †	—	—	CW	1-6	1-1-1, 6-6-6*	1-C	4-7	4-4-4, 7-7-7*	4-C
				0-280	45**	5.5 †	—	—	CCW	4-7	4-4-4, 7-7-7*	4-C	1-6	1-1-1, 6-6-6*	1-C
#4 3-PHASE WYE		480	50/60	0-480	15	12.5	19	15.8	CW	4-4-4	1-1-1	3-3-3	1-1-1	4-4-4	3-3-3
				0-480	15	12.5	19	15.8	CCW	1-1-1	4-4-4	3-3-3	4-4-4	1-1-1	3-3-3
		240	60	0-560	15	14.5	—	—	CW	2-2-2	1-1-1	3-3-3	5-5-5	4-4-4	3-3-3
				0-560	15	14.5	—	—	CCW	5-5-5	4-4-4	3-3-3	2-2-2	1-1-1	3-3-3
				0-560	15**	6.3 †	—	—	CW	6-6-6	1-1-1	3-3-3	7-7-7	4-4-4	3-3-3
				0-560	15**	6.3 †	—	—	CCW	7-7-7	4-4-4	3-3-3	6-6-6	1-1-1	3-3-3

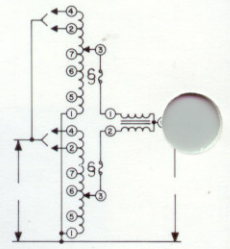

CONNECTION 1

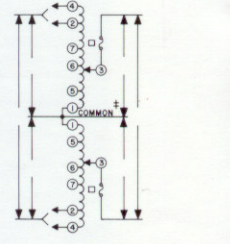

CONNECTION 2

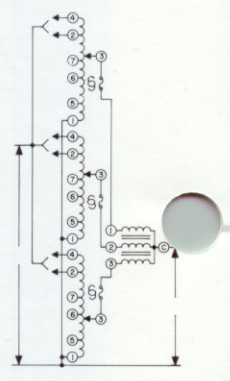

CONNECTION 3

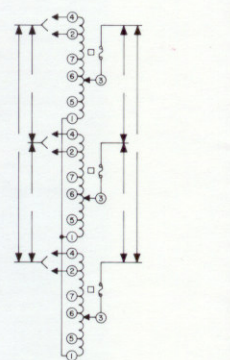

CONNECTION 4

146 TYPES
DO NOT HAVE
TERMINALS
6 OR 7

CONNECTIONS
SHOWN ARE FOR
CW KNOB
ROTATION,
KNOB ON
RADIATOR END
(CCW ROTATION,
KNOB ON BASE END

*Jumpers also required connecting #3 on first unit to #1 on choke, #3 on second unit to #2 on choke and #3 on third unit to #3 on choke. T6065 choke required for 146 types, T5579B choke for 246 types.

**Maximum output current in output voltage range from 0 to 25 percent above line voltage. At higher output voltages output current must be reduced according to rating curve Figure B on page 4.

†Jumpers also required connecting #3 on first unit to #1 on choke and connecting #3 on second unit to #2 on choke. T6053 choke required for 146T types, T5000B choke for 246 types.

‡Common used as third leg in 3-phase open delta or neutral in 3-wire single phase series and 4-wire 3-phase wye connections; not used in 2-wire series or 3-wire wye connections.

§Units must be fused. 30 ampere fuses supplied internally on F146 types, 15 ampere on F246 types. On other types, fuses, must be wired as shown.

¶Maximum KVA at maximum output voltage. Maximum KVA at lower output voltages may be calculated from rating curve Figure B on page 4.

□Fuses recommended on all units. 30 ampere fuses supplied internally on F146 types, 15 ampere on F246 types.

»Jumper provided in standard common position should be moved or removed as required.

☆Motor-driven types use connections for CW rotation, knob on radiator end.

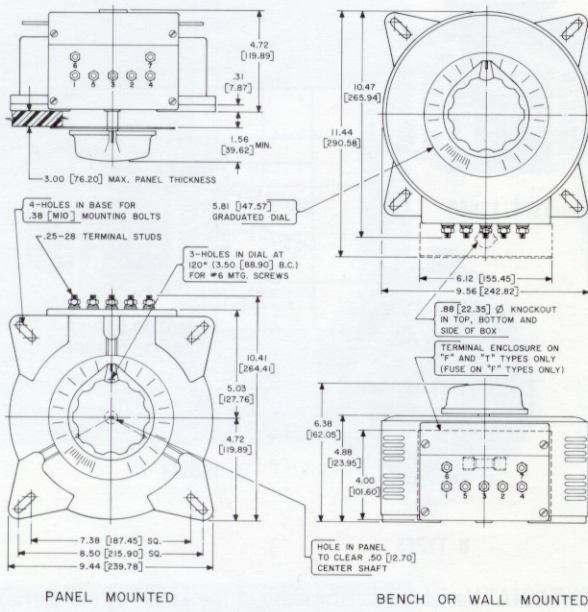

PANEL MOUNTED

BENCH OR WALL MOUNTED

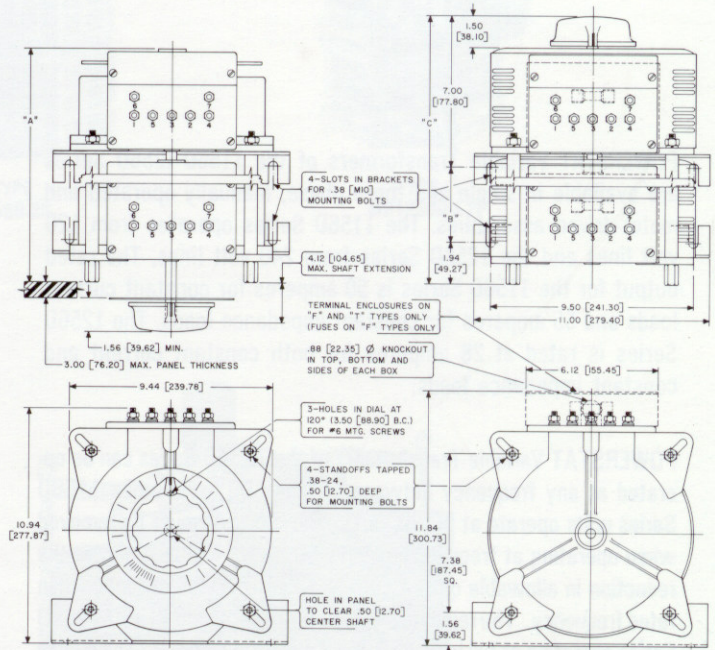

MANUAL

TYPE	"A"	"B"	"C"	"D"	"E"	"F"
SINGLE UNIT	—	—	—	13.19 [335.03]	12.16 [308.86]	5.19 [131.83]
2-GANG	10.84 [275.33]	3.56 [90.42]	12.50 [317.50]	18.31 [465.07]	12.28 [311.91]	10.31 [261.87]
3-GANG	15.97 [405.63]	8.69 [220.72]	17.62 [447.55]	23.44 [595.38]	22.41 [569.21]	15.44 [392.18]

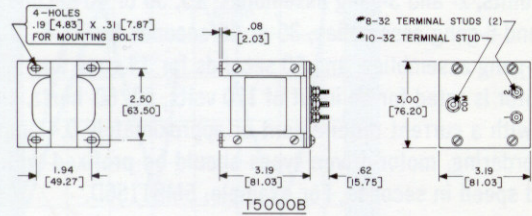

T5000B

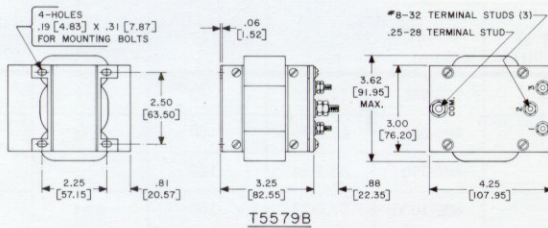

T5579B

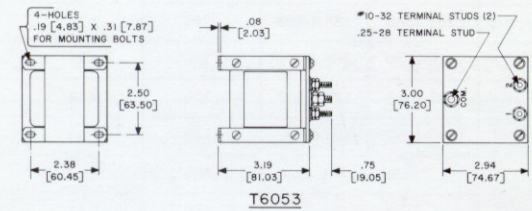

T6053

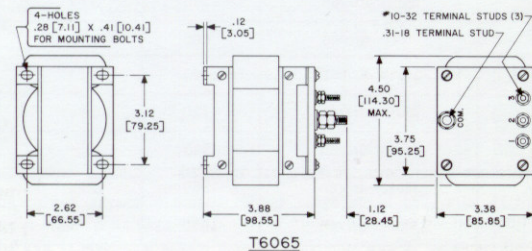

T6065

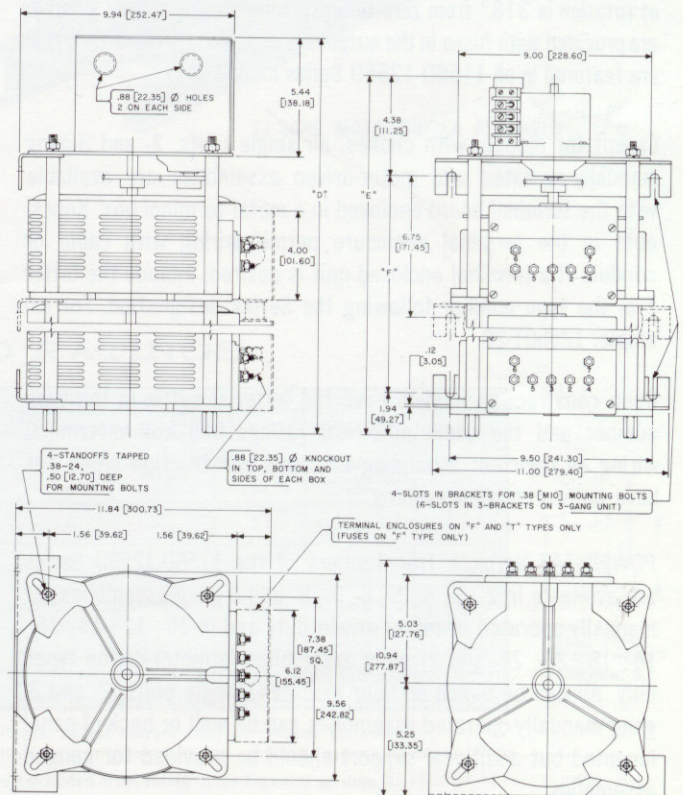

MOTOR DRIVEN