

## POWR-BLOK™ Modules



<b>Powr-Blok™ Modules: Introduction</b>	<b>1</b>
<b>Fuse Modules</b>	<b>2</b>
2-Position ATO® Style Fuse and Circuit Breaker Module	2
4-Position ATO® Style Fuse and Circuit Breaker Module	2
7-Position ATO® Style Fuse and Circuit Breaker Module	3
4-Position MINI® Style Fuse Module	3
6-Position MINI® Style Fuse Module	4
8-Position MINI® Style Fuse Module	4
2-Position MAXI™ Style Fuse Module	5
4-Position MAXI™ Style Fuse Module	5
<b>Relay Modules</b>	<b>6</b>
1-Position ISO Relay Module	6
2-Position ISO Relay Module	6
3-Position Micro Relay Module	7
1-Position 9 Pin Relay Module	7
2-Position 280 Micro Relay + 2 Position MINI® Style Fuse	8
1-Position Power Relay Module	8
2-Pin Flasher Module	9
<b>Specialty Modules</b>	<b>10</b>
Blank Module	10
2-Position Blank Module	10
Power Tap Module	11
2-Stud Assembly Module	11
4-Stud Assembly Module	12
2-Position Push Button Circuit Breaker Module	12
Storage Module/Drawer Insert	13
Splash Proof Cover for: 4-Position MINI® Fuse Module	13
<b>Assembly/Mounting Accessories</b>	<b>14</b>
Assembly Accessories—BLOK-LOKS™	14
Mounting Accessories—Mounting Standoffs	14
Mounting Accessories—Mounting Module	15
Mounting Leg	15
Mounting Accessories—Flush Mounting Leg	16
Side Mounting Bracket	16
<b>Terminals</b>	<b>17-21</b>
<b>Starter Terminals</b>	<b>22</b>
<b>Terminal Loks</b>	<b>23</b>

## POWR-BLOK™ MODULES

### Description

The Littelfuse POWR-BLOKS™ system gives you unlimited flexibility to design electrical distribution systems. It's a totally modular way to build your own junction box. POWR-BLOKS are perfect for applications where space or vehicle function demand a tailor made approach. The Littelfuse POWR-BLOKS can be modified, re-sized, reconfigured or added to at any time.



### Mechanical Strength for Any Application

POWR-BLOKS modules are molded from glass reinforced nylon for dimensional stability, excellent rigidity, high and low temperature resistance and tensile strength:

### Specifications

Test	POWR-BLOKS™ Standard
Voltage Rating	48VDC
Temperature range	-40°C to +125°C
Durability	Minimum 50 cycles of engagement/ disengagement
Drop	1.22 meters onto wooden platform
Thermal Shock	5 Cycles from -40°C to +125°C
Mechanical Shock	50g in each of 3 mutually perpendicular axis
Fluid Compatibility	Gasoline, diesel fuel, motor oil, antifreeze, brake fluid, ATF

### \*Max. Current Indication

The information listed as Max. current indication is to be used as a guideline only. The maximum allowable rating of the fuses used depends on design criteria such as maximum current, nominal current the duration for which the circuits are energized, as well as external factors as ambient temperature. All modules should therefore be tested as an assembly, and users should make their own evaluation to determine the suitability of the product for their specific applications.

### How to use the Littelfuse POWR-BLOKS system

1. Identify the electrical system parameters
  - Space availability and requirements
  - Circuit protection components
  - Relay and flasher components
  - Components for special needs
2. Select the Littelfuse POWR-BLOKS components. Lay out the electrical panel as designed. Then determine the appropriate type and quantity of POWR-BLOKS modules, BLOK LOKS and TERMINAL LOKS you need.
3. Build the panel by row. POWR-BLOKS can be assembled without special tools. Assemble the block from the rear by placing all modules face down on a flat surface. POWR-BLOKS should be designed by row, either going across or up and down.
4. Use BLOK LOKS to interconnect modules. BLOK LOKS are used to connect and stack POWR-BLOKS modules. Press together a row of modules and insert green BLOK LOKS until they snap into place. Repeat this procedure to interlock all assembled rows.
5. Add mounting modules. Once a POWR-BLOKS panel is assembled, add mounting modules that are most suitable for your application. Mounting options include surface mounting legs, a side mounting bracket and a mounting module with three different sized spacers.
6. Plug in terminated wiring. Wire your POWR-BLOKS panel and plug in the terminated wires, then insert the optional matching TERMINAL LOKS devices. Littelfuse TERMINAL LOKS are designed to fit special POWR-BLOKS modules and inserted in the same manner as BLOK LOKS.

The information and illustrations given in this catalogue are believed to be reliable and accurate. Littelfuse makes no warranties as to their accuracy or completeness, and disclaims any liability in connection with their use. Littelfuse's only obligations are those in the standard terms of sale for this product and Littelfuse will not be liable for any consequential or other damages arising out of the use or misuse of this product. Littelfuse reserves the right to make changes to the contents hereof without notice. It is suggested that at the time of inquiry Littelfuse Sales personnel be contacted directly for verification of published specifications and product availability.

## 2-POSITION ATO® STYLE FUSE AND CIRCUIT BREAKER MODULE

RoHS



### Dimensions

Dimensions in mm



### Ratings

Part Number	Max. Current Indication	Terminals (see according section)	Terminal Loks (see according section)
03540501Z (40 pcs.)	60A	Type 1 or 7	Type 4, 5 or 6

## 4-POSITION ATO® STYLE FUSE AND CIRCUIT BREAKER MODULE

RoHS



### Dimensions

Dimensions in mm



### Ratings

Part Number	Max. Current Indication	Terminals (see according section)	Terminal Loks (see according section)
03540502Z (20 pcs.)	120A	Type 1 or 7	Type 4, 5, 6 or 7

# 7-POSITION ATO® STYLE FUSE AND CIRCUIT BREAKER MODULE

RoHS

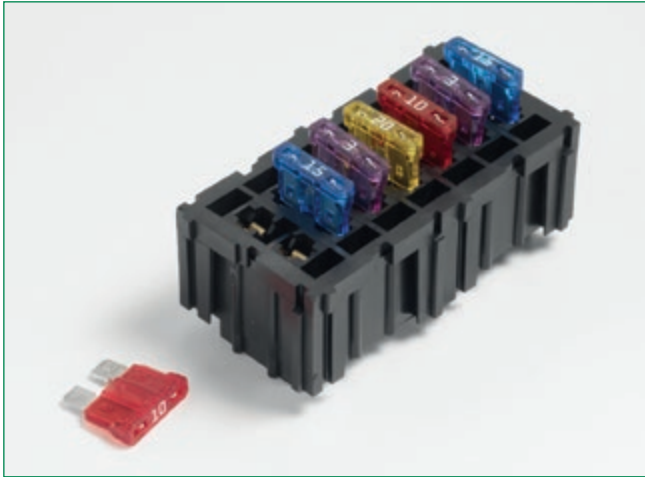

## Dimensions

Dimensions in mm

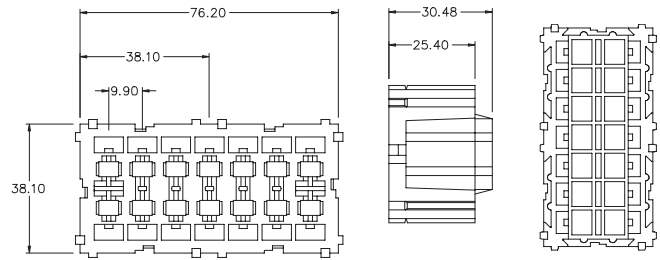

## Ratings

Part Number	Max. Current Indication	Terminals (see according section)	Terminal Loks (see according section)
03540503Z (20 pcs.)	120A	Type 1 or 7	Type 4 or 5

# 4-POSITION MINI® STYLE FUSE MODULE

RoHS



## Dimensions

Dimensions in mm



## Ratings

Part Number	Max. Current Indication	Terminals (see according section)	Terminal Loks (see according section)
03540532Z (40 pcs.)	60A	Type 6	—

## 6-POSITION MINI® STYLE FUSE MODULE

RoHS



### Dimensions

Dimensions in mm



### Ratings

Part Number	Max. Current Indication	Terminals (see according section)	Terminal Loks (see according section)
03540543Z (40 pcs.)	60A	Type 8	—

## 8-POSITION MINI® STYLE FUSE MODULE

RoHS



### Dimensions

Dimensions in mm



### Ratings

Part Number	Max. Current Indication	Terminals (see according section)	Terminal Loks (see according section)
03540544Z (40 pcs.)	60A	Type 8	—

## 2-POSITION MAXI™ STYLE FUSE MODULE

RoHS



### Dimensions

Dimensions in mm



### Ratings

Part Number	Max. Current Indication	Terminals (see according section)	Terminal Loks (see according section)
03540549Z (40 pcs.)	80A	Type 2	Type 8

## 4-POSITION MAXI™ STYLE FUSE MODULE

RoHS

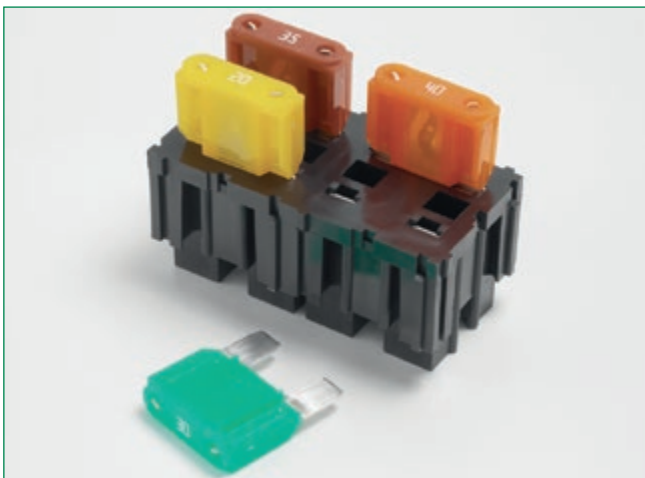

### Dimensions

Dimensions in mm

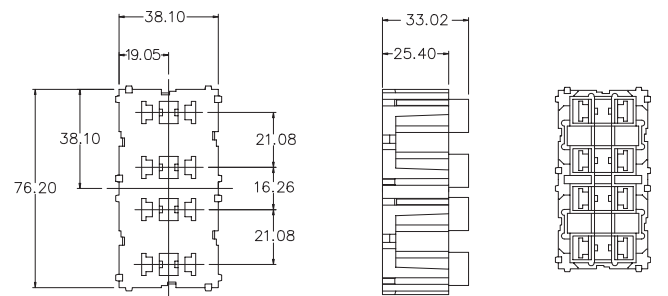

### Ratings

Part Number	Max. Current Indication	Terminals (see according section)	Terminal Loks (see according section)
03540505Z (20 pcs.)	160A	Type 2	Type 8

## 1-POSITION ISO RELAY MODULE

Alternative for: 3 pin flasher module

**RoHS**



### Dimensions

Dimensions in mm



### Ratings

Part Number	Remarks	Terminals (see according section)	Terminal Loks (see according section)
03540506Z (40 pcs.)	-	Type 3	Type 1

## 2-POSITION ISO RELAY MODULE

Alternative for: 3 pin flasher module

**RoHS**



### Dimensions

Dimensions in mm



### Ratings

Part Number	Remarks	Terminals (see according section)	Terminal Loks (see according section)
03540536Z (20 pcs.)	-	Type 3	Type 1



## 3-POSITION MICRO RELAY MODULE

RoHS



### Dimensions

Dimensions in mm

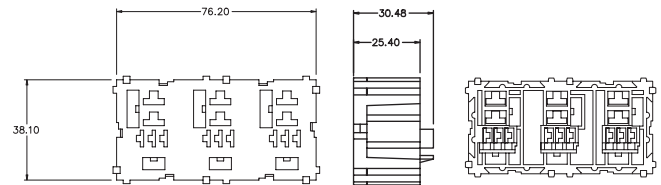

### Ratings

Part Number	Max. Current Indication	Terminals (see according section)	Terminal Loks (see according section)
03540507Z (20 pcs.)	Coil and normally closed contacts	Type 5	Type 3
03540507Z (20 pcs.)	Normally open contacts	Type 3	Type 2

## 1-POSITION 9 PIN RELAY MODULE

RoHS



### Dimensions

Dimensions in mm

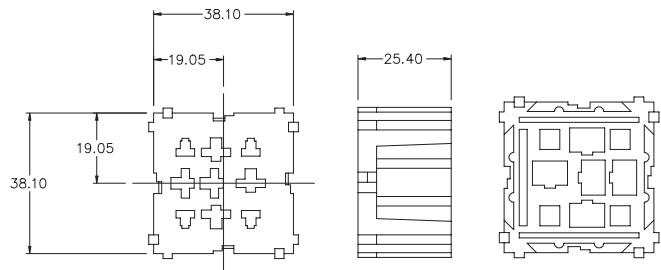

### Ratings

Part Number	Max. Current Indication	Terminals (see according section)	Terminal Loks (see according section)
03540542Z (40 pcs.)	5 "Inner" pins	Type 3	Type 1
03540542Z (40 pcs.)	4 "Outer" pins	Type 6	-



**2-POSITION 280 MICRO RELAY + 2 POSITION MINI® STYLE FUSE**

**RoHS**



**Dimensions**

Dimensions in mm



**Ratings**

Part Number	Max. Current Indication	Terminals (see according section)	Terminal Loks (see according section)
03540551Z (40 pcs.)	Max. current indication 30A	Type 8	-

**1-POSITION POWER RELAY MODULE**

**RoHS**



**Dimensions**

Dimensions in mm



**Ratings**

Part Number	Max. Current Indication	Terminals (see according section)	Terminal Loks (see according section)
03540535Z (40 pcs.)	Coil	Type 3	Type 1
03540535Z (40 pcs.)	Contacts	Type 4	-

# 2-PIN FLASHER MODULE

RoHS

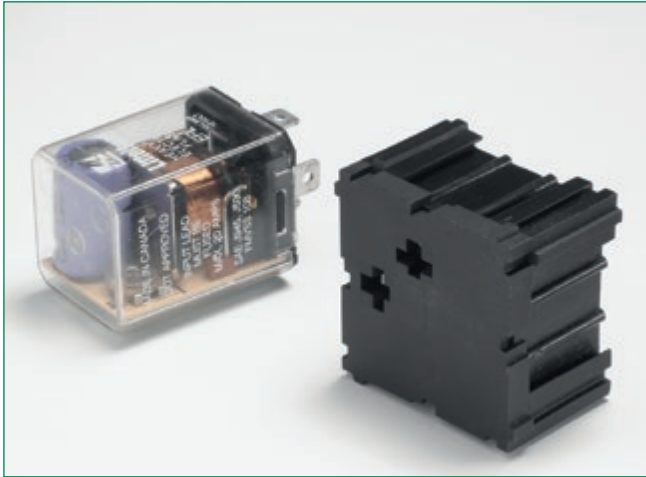

## Dimensions

Dimensions in mm

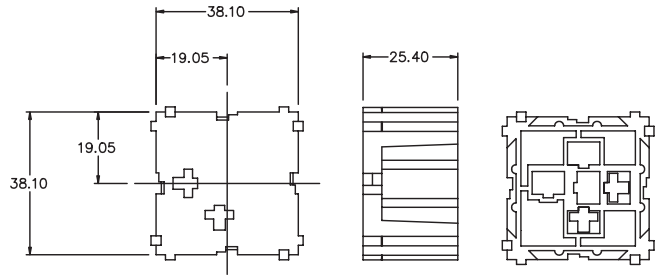

## Ratings

Part Number	Max. Current Indication	Terminals (see according section)	Terminal Loks (see according section)
03540508Z (40 pcs.)	-	Type 3	Type 1

**BLANK MODULE**

**RoHS**



**Dimensions**

Dimensions in mm



**Ratings**

Part Number	Remarks
03540520Z (40 pcs.)	-

**2-POSITION BLANK MODULE**

**RoHS**



**Dimensions**

Dimensions in mm



**Ratings**

Part Number	Remarks
03540550Z (20 pcs.)	-

## POWER TAP MODULE

RoHS



### Dimensions

Dimensions in mm

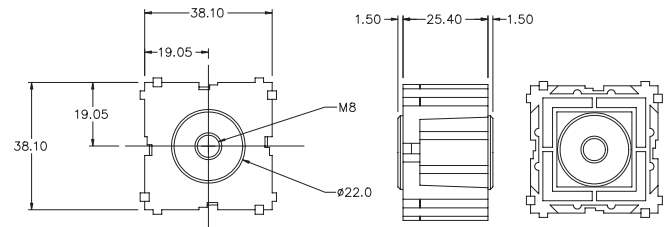

### Ratings

Part Number	Remarks
03540539Z (40 pcs.)	M8 Tread Metric
03540512Z (100 pcs.)	1/4 inch - 20 thread
03540513Z (100 pcs.)	5/16 inch - 18 thread

## 2-STUD ASSEMBLY MODULE

RoHS



### Dimensions

Dimensions in mm



### Ratings

Part Number	Remarks
03540537Z (20 pcs.)	M6 Thread, Metric

## 4-STUD ASSEMBLY MODULE

RoHS



### Dimensions

Dimensions in mm



### Ratings

Part Number	Remarks
03540538Z (20 pcs.)	M6 Thread Metric

## 2-POSITION PUSH BUTTON CIRCUIT BREAKER MODULE

RoHS



### Dimensions

Dimensions in mm



### Ratings

Part Number	Remarks
03540504Z (20 pcs.)	-

# STORAGE MODULE/DRAWER INSERT

RoHS



## Dimensions

Dimensions in mm



## Ratings

Part Number	Remarks
03540521Z (20 pcs.)	Body
03540522Z (20 pcs.)	Drawer

# SPLASH PROOF COVER FOR: 4-POSITION MINI® FUSE MODULE

RoHS



## Dimensions

Dimensions in mm

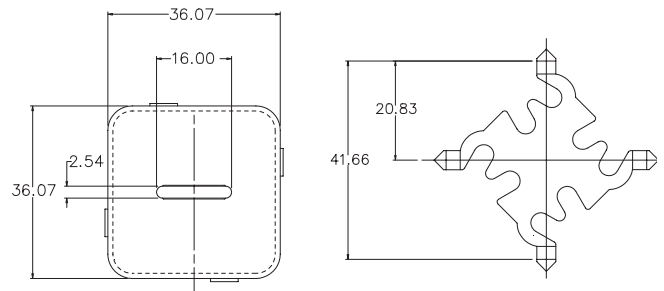

## Ratings

Part Number	Remarks
03540534Z (20 pcs.)	Cover
03540533Z (20 pcs.)	Lock
09130085Z (20 pcs.)	Seal

**ASSEMBLY ACCESSORIES—BLOK LOKS™**

**RoHS**



**Dimensions**

Dimensions in mm



**Ratings**

Part Number	Remarks
03540523Z (250 pcs.)	—

**MOUNTING ACCESSORIES—MOUNTING STANDOFFS**

**RoHS**



**Dimensions**

Dimensions in mm



**Ratings**

Part Number	Remarks
03540515Z (10 pcs.)	0.75 Inch / 19mm
03540516Z (10 pcs.)	1 Inch / 25.4mm
03540517Z (10 pcs.)	1.25 Inch / 31.7mm



MOUNTING ACCESSORIES—MOUNTING MODULE

RoHS

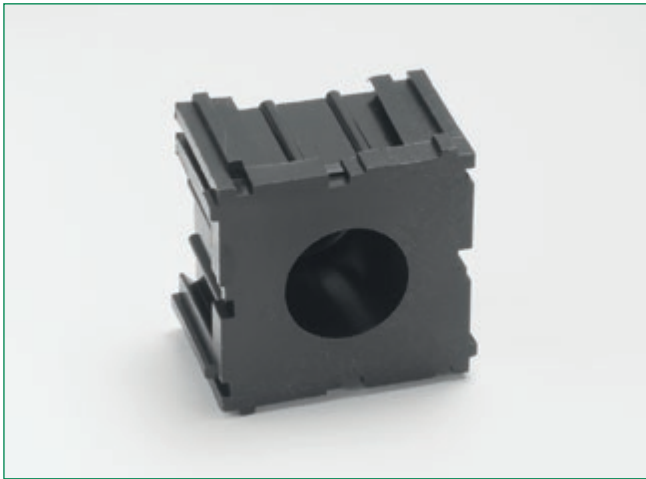

**Dimensions**

Dimensions in mm

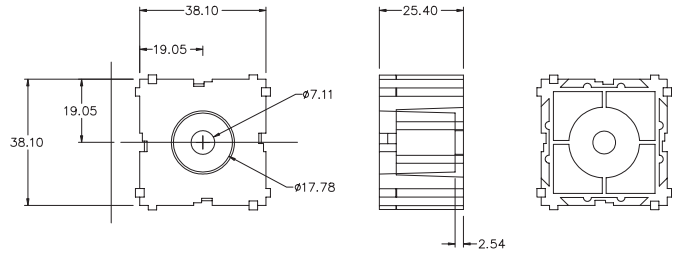

**Ratings**

Part Number	Remarks
03540514Z (40 pcs.)	—

MOUNTING LEG

RoHS



**Dimensions**

Dimensions in mm

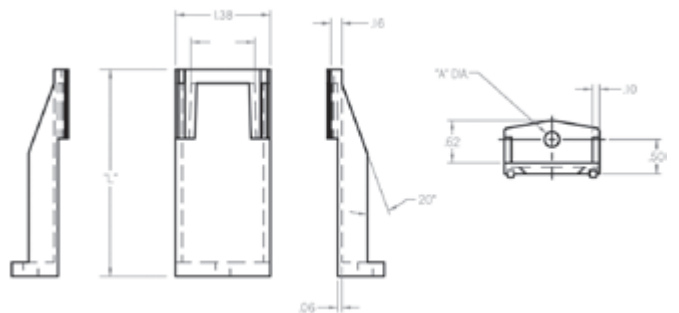

**Ratings**

Part Number	Remarks
03540541Z (50 pcs.)	2.50 Inch / 63.5mm
03540518Z (50 pcs.)	3 Inch / 76.2mm

**MOUNTING ACCESSORIES—FLUSH MOUNTING LEG**

**RoHS**



**Dimensions**

Dimensions in mm



**Ratings**

Part Number	Remarks
03540519Z (50 pcs.)	—

**SIDE MOUNTING BRACKET**

**RoHS**



**Dimensions**

Dimensions in mm



**Ratings**

Part Number	Remarks
03540540Z (50 pcs.)	—

# TERMINAL TYPE 1

RoHS



## Terminal Loks

Description	Wire Diam.	Type of terminal loks
For part number: 354501 / 354502 / 354503	0.50 - 2 mm <sup>2</sup>	4
For part number: 354501 / 354502 / 354503	0.50 - 2 & 3.3 - 5.3 mm <sup>2</sup>	5
For part number: 354501 / 354502	0.50 - 2 mm <sup>2</sup>	6
For part number: 354502	0.50 - 2 mm <sup>2</sup>	7

## Ratings

Part Number	Description	Wire Diam.	Material
913-070 (Reeled per 2200 pcs) 0913070001 (Single per 250 pcs)	Heavy Duty + spring clip*	0.5-0.8 mm <sup>2</sup> / 18-20AWG 0.5-0.8 mm <sup>2</sup> / 18-20AWG	Brass
913-071 (Reeled per 2200 pcs) 913-071XS (Reeled per 2200 pcs)	Heavy Duty + spring clip*	1.33-2.09 mm <sup>2</sup> / 14-16AWG 1.33-2.09 mm <sup>2</sup> / 14-16AWG	Brass Silver plated copper
0913071001 (Single per 250 pcs) 913-072 (Reeled per 2200 pcs)	Heavy Duty + spring clip*	1.33-2.09 mm <sup>2</sup> / 14-16AWG 3.32-5.37 mm <sup>2</sup> / 10-12AWG	Brass
913-072XS (Reeled per 2200 pcs) 0913072001 (Single per 250 pc)	Heavy Duty + spring clip*	3.32-5.37 mm <sup>2</sup> / 10-12AWG 3.32-5.37 mm <sup>2</sup> / 10-12AWG	Silver plated copper Brass
913-058 (Reeled per 4500 pcs) 0913058001 (Single per 250 pcs)	Standard Duty	0.5-0.8 mm <sup>2</sup> / 18-20AWG 0.5-0.8 mm <sup>2</sup> / 18-20AWG	Brass
913-059 (Reeled per 4500 pcs) 0913059001 (Single per 250 pcs)	Standard Duty	1.33-2.09 mm <sup>2</sup> / 14-16AWG 1.33-2.09 mm <sup>2</sup> / 14-16 AWG	Brass
913-060 (Reeled per 4500 pcs) 0913060001 (Single per 250 pcs)	Standard Duty	3.32-5.37 mm <sup>2</sup> / 10-12AWG 3.32-5.37 mm <sup>2</sup> / 10-12AWG	Brass

\* Spring clip material: Stainless steel

## TERMINAL TYPE 2

RoHS



### Terminal Loks

Description	Wire Diam.	Type of terminal loks
For part number: 354505	0,50 - 2 mm <sup>2</sup>	8

### Ratings

Part Number	Description	Wire Diam.	Material
913-063 (Reeled per 1200 pcs) 0913063001 (Single per 250 pcs)	Female 8.0 mm	0.82-1.33 mm <sup>2</sup> / 18-16AWG 0.82-1.33 mm <sup>2</sup> / 18-16AWG	Silver plated brass
913-064 (Reeled per 1200 pcs) 0913064001 (Single per 250 pcs)	Female 8.0 mm	2.09-3.32 mm <sup>2</sup> / 14-12AWG 2.09-3.32 mm <sup>2</sup> / 14-12AWG	Silver plated brass
913-068 (Reeled 1200 pcs) 0913068001 (Single per 250 pcs)	Female 8.0 mm	5.37mm <sup>2</sup> / 10AWG 5.37mm <sup>2</sup> / 10AWG	Silver plated brass

## TERMINAL TYPE 3

RoHS



### Terminal Loks

Description	Wire Diam.	Type of terminal loks
For part number: 354506 / 354508 / 354535 / 354536	-	1
For part number: 354505	-	2

### Ratings

Part Number	Description	Wire Diam.	Material
913-053 (Reeled per 2000 pcs) 0913053001 (Single per 250 pcs)	-	0.5-0.8 mm <sup>2</sup> / 18-20AWG 0.5-0.8 mm <sup>2</sup> / 18-20AWG	Tin plated brass
913-253 (Reeled per 3000 pcs)	-	0.5-1.00 mm <sup>2</sup> (metric)	Tin plated brass
913-065 (Reeled per 2100 pcs) 0913065001 (Single per 250 pcs)	-	1.33-2.09 mm <sup>2</sup> / 14-16AWG 1.33-2.09 mm <sup>2</sup> / 14-16AWG	Tin plated brass
913-265 (Reeled per 2500 pcs)	-	1.1-2.50 mm <sup>2</sup> (metric)	Tin plated brass
913-055 (Reeled per 1900 pcs) 0913055001 (Single per 250 pcs)	-	3.32-5.37 mm <sup>2</sup> / 10-12AWG 3.32-5.37 mm <sup>2</sup> / 10-12AWG	Tin plated brass
913-255 (Reeled per 15000 pcs)	-	4.0-6.0 mm <sup>2</sup> (metric)	Tin plated brass

## TERMINAL TYPE 4

RoHS



### Ratings

Part Number	Description	Wire Diam.	Material
913-073 (Reeled per 2000 pcs) 0913073001 (Single per 250 pcs)	Female	3.0-6.0 mm <sup>2</sup> /10-12AWG 3.0-6.0 mm <sup>2</sup> /10-12AWG	Tin plated Brass
913-074 (Reeled per 1000 pcs) 0913074001 (Single per 250 pcs)	Female	6.0-10.0 mm <sup>2</sup> /8-10AWG 6.0-10.0 mm <sup>2</sup> /8-10AWG	Tin plated Brass

## TERMINAL TYPE 5

RoHS



### Ratings

Part Number	Description	Wire Diam.	Material
913-067 (Reeled per 3500 pcs) 0913067001 (Single per 250 pcs)	Female	0.82-1.33 mm <sup>2</sup> /16-18AWG 0.82-1.33 mm <sup>2</sup> /16-18AWG	Tin plated silicon bronze
913-066 (Reeled per 3000 pcs) 0913066001 (Single per 250 pcs)	Female	2.09-3.32 mm <sup>2</sup> /12-14AWG 2.09-3.32 mm <sup>2</sup> /12-14AWG	Tin plated silicon bronze

## TERMINAL TYPE 6

RoHS



### Ratings

Part Number	Description	Wire Diam.	Material
913-772 (Reeled per 2500 pcs) 0913772001 (Single per 250 pcs)	Female	0.5-0.8 mm <sup>2</sup> /18-20AWG 0.5-0.8 mm <sup>2</sup> /18-20AWG	Tin plated brass
913-773 (Reeled per 2500 pcs) 0913773001 (Single per 250 pcs)	Female	1.33-2.09 mm <sup>2</sup> /14-16AWG 1.33-2.09 mm <sup>2</sup> /14-16AWG	Tin plated brass
913-774 (Reeled 2000 pcs) 0913774001 (Single per 250 pcs)	Female	3.32-5.37 mm <sup>2</sup> /10-12AWG 3.32-5.37 mm <sup>2</sup> /10-12AWG	Tin plated brass

## TERMINAL TYPE 7

RoHS

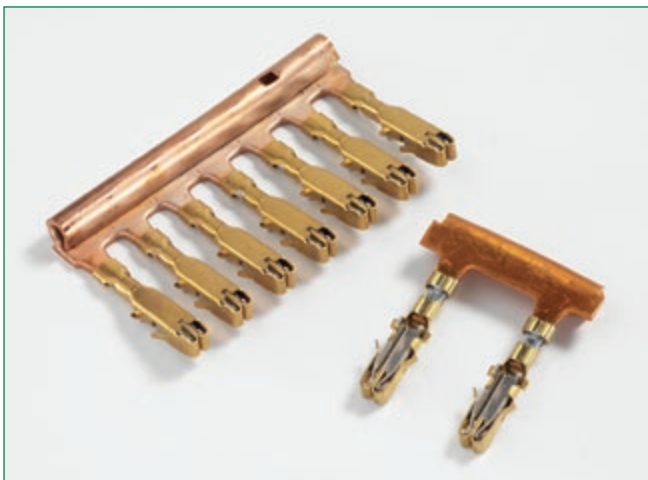

### Ratings

Part Number	Description	Wire Diam.	Material
09130075Z (Per 20 pcs)	Bus bar 2 position	5.0-8.0 mm <sup>2</sup> /8-10AWG	Copper
09130076Z (Per 20 pcs)	Bus bar 4 position	5.0-8.0 mm <sup>2</sup> /8-10AWG	Copper
09130077Z (Per 20 pcs)	Bus bar 7 position	5.0-8.0 mm <sup>2</sup> /8-10AWG	Copper

# TERMINAL TYPE 8

RoHS



## Ratings

Part Number	Description	Wire Diam.	Material
913-769 (Reeled per 4200 pcs) 0913769001 (Single per 250 pcs)	Female	0.5-1.0 mm <sup>2</sup> 0.5-1.0 mm <sup>2</sup>	Part.Gold plated Brass
913-770 (Reeled per 1000 pcs) 0913770001 (Single per 250 pcs)	Female	1.5-2.5 mm <sup>2</sup> 1.5-2.5 mm <sup>2</sup>	Tin plated bronze



# STARTER TERMINALS

**RoHS**



## Description

The starter terminal series are cable lugs for heavy-duty applications such as starter motors and battery connections.

## Ratings

Part Number	mm <sup>2</sup>	Mounting Hole	Width (mm)	Material	Plating	Ref.
09130633LXN (50 pcs) 09130633Z (1250 pcs)	2.5-6.0	6.5 mm	11	Cu	Sn	2906
09130634LXN (50 pcs) 09130634Z (600 pcs)	6.0-15	8.4 mm	15	Cu	Sn	2910
09130635LXN (50 pcs) 09130635Z (400 pcs)	10 -25	8.4 mm	15	Cu	Sn	2916
09130636LXN (50 pcs) 09130636Z (200 pcs)	16-35	10.5 mm	19	Cu	Sn	29025
09130637LXN (50 pcs) 09130637Z (150 pcs)	25-50	10.5 mm	19	Cu	Sn	29035
09130638LXN (50 pcs) 09130638Z (100 pcs)	35-70	10.5 mm	19	Cu	Sn	29050
09130639LXN (50 pcs) 09130639Z (50 pcs)	50-95	13.5 mm	22	Cu	Sn	29070
09130640LXN (50 pcs) 09130640Z (600 pcs)	16	6.4 mm	11	Cu	Sn	2916 HK
09130641LXN (50 pcs) 09130641Z (300 pcs)	25	8.4 mm	15	Cu	Sn	29025 HK
09130642LXN (50 pcs) 09130642Z (200 pcs)	35	8.4 mm	15	Cu	Sn	29035 HK (8.4)
09130643LXN (50 pcs) 09130643Z (150 pcs)	35	10.5 mm	19	Cu	Sn	29035 HK (10.5)
09130644LXN (50 pcs) 09130644Z (100 pcs)	50	8.4 mm	17	Cu	Sn	29050 HK (8.4)
09130645LXN (50 pcs) 09130645Z (125 pcs)	50	10.5 mm	19	Cu	Sn	29050 HK (10.5)
09130646LXN (50 pcs) 09130646Z (75 pcs)	70	10.5 mm	21	Cu	Sn	29070 HK

# TERMINAL LOKS

RoHS

**Terminal Lok Type 1**



**Terminal Lok Type 5**



**Terminal Lok Type 2**



**Terminal Lok Type 6**



**Terminal Lok Type 3**



**Terminal Lok Type 7**



**Terminal Lok Type 4**



**Terminal Lok Type 8**



# Mouser Electronics

Authorized Distributor

Click to View Pricing, Inventory, Delivery & Lifecycle Information:

[Littelfuse:](#)

[09130085Z](#) [0913064001](#)