

INSTRUCTION MANUAL

T512

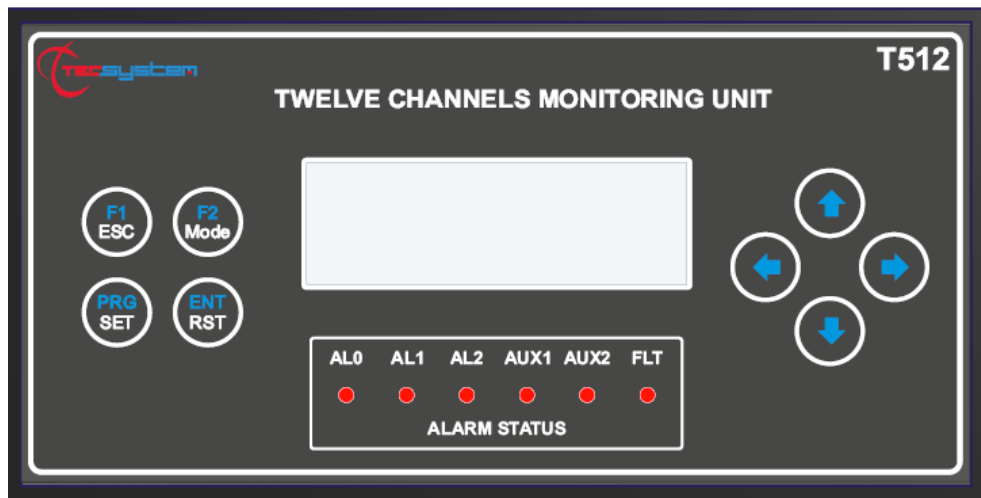

1MN0075 REV. 0



operates with ISO9001 certified quality system

TECSYSTEM S.r.l.
20094 Corsico (MI)
Tel.: +39-024581861
Fax: +39-0248600783

<http://www.tecsystem.it>

R. 1.5 30/10/17

ENGLISH

“Translations of the original instructions”

INTRODUCTION

First of all we wish to thank you for choosing to use a **TECSYSTEM** product and recommend you read this instruction manual carefully: You will understand the use of the equipment and therefore be able to take advantage of all its functions.

ATTENTION! THIS MANUAL IS VALID AND COMPLETE FOR THE **T512 / T512 MODBUS INSIDE** MONITORING UNIT.

CONTENTS

	PAGE
1) SAFETY REQUIREMENTS	4
2) ACCESSORIES	5
3) TECHNICAL SPECIFICATIONS	6
4) FRONT PANEL	8
5) MOUNTING	9
6) ELECTRICAL CONNECTIONS	10
• T512 BACK	—
• POWER SUPPLY	—
• WIRING NOTES	11
• PROGRAMMED DATA DIAGNOSTICS	—
• SENSOR CONNECTION	—
• TEMPERATURE SENSOR DIAGNOSTICS	12
• TEMPERATURE DIAGNOSTICS	—
• DISPLAY MODE	—
• USE AND WORKING OF T512 CONTROL UNIT	—
7) PROGRAMMING	13
• PROGRAMMING MENU '	—
• PROGRAMMING OF CHANNELS SETTING PAGE	—
• PROGRAMMING T512 SETTING PAGE	14
• FACTORY DEFAULT SELECTION	15
• FACTORY DEFAULT SETTINGS	—
• RELAYS LOGIC (AL/AUX).	—
8) MODBUS OPTION	17
• OPERATING NOTES	—
• DATA TRANSMISSION ON MODBUS NETWORK	—
• RS485 ELECTRICAL CONNECTIONS	—

	PAGE
• DATA FRAME	—
• DATA PACKET	—
• FUNCTION CODE	—
• CODE 3(10).	—
• CODE 16(10).	18
• NOTES FOR REMOTE PROGRAMMING	—
• ERROR CODES (exception code)	—
• POLLING FREQUENCY	—
• CRC CALCULATION	—
• PARAMETER DESCRIPTION	—
• ALGORITHM	—
• MODBUS PARAMETER PROGRAMMING	19
• MODBUS TEMPERATURE MAPPING	—
• CHANNEL STATE AND SETTING MAPPING	20
• AL0 MAPPING	—
• AL1 MAPPING	21
• AL2 MAPPING	—
• 121—125 MAPPING	—
9) WARRANTY CONDITIONS	22
10) TROUBLESHOOTING	23
11) EQUIPMENT DISPOSAL	—
12) UL SPECIFICATION AND RATINGS	—
13) USEFUL CONTACTS	24

SAFETY REQUIREMENTS



ATTENTION :

Read the manual carefully before starting to use the control unit. Keep the instructions for future reference.



Do not open the device, touching any internal components can cause electric shock. Contact a voltage over 50 Volts can be fatal. To reduce the risk of electric shock, do not dismantle the back of the device for any reason. Moreover its opening would void the warranty.

Before connecting the device to the power supply, make sure that all the connections are correct. Always disconnect the unit from the supply before any cabling modification.



Any work on the equipment must be entrusted to a qualified engineer.

Failure to comply with these instructions can cause damages, fires or electric shock, and possible serious injuries!

POWER SUPPLY

The T512 series control unit has UNIVERSAL power supply, i.e. it can be supplied by 24 to 240 Vac-Vdc, irrespectively of polarity in Vdc.

Before using it, make sure the power cable is not damaged, knotted or pinched. Do not tamper with the power cable. Never disconnect the unit by pulling the cable, avoid touching the pins. Do not carry out any connecting/disconnecting with wet hands. To disconnect the device, do not use objects such as levers. Immediately disconnect the device if you smell burning or see any smoke: contact technical service.

LIQUIDS

Do not expose the equipment to splashes or drops, do not position it in places with humidity exceeding 90% and never touch with wet or humid hands during storms. If any liquid penetrates the control unit, disconnect it immediately and contact technical service.

CLEANING

Disconnect the power cable before cleaning the control unit, use a dry cloth to dust it, without any solvent or detergents, and compressed air.

OBJECTS

Never insert any objects into the cracks of the control unit. If this happens, disconnect the control unit and contact an engineer.

USE RESERVED TO QUALIFIED PERSONNEL

The purchased goods are a sophisticated electronic device that is totally unsuitable to be used by non-qualified personnel. Any work must be carried out by a specialist engineer.

ACCESSORIES

The use of non-original accessories or spare parts can damage the unit and endanger users' safety. In the event of faults, contact technical service.

LOCATION

Install the control unit indoors, in a place protected from water splashes and sun rays. Do not place near heat sources exceeding the parameters stated in this manual. Position on a stable surface, far from any possible vibrations. Position the unit as far as possible from any intense magnetic fields.

REPAIRS

Do not open the control unit. For any fault, always use qualified personnel. The opening of the control unit and/or the removal of the series identifying label entails the automatic forfeiture of the warranty. The Warranty seal is applied to all devices, any attempt to open the unit would break the seal and cause the consequent automatic forfeiture of the warranty.

TECHNICAL INFORMATION

Mail: ufficiotecnico@tecsystem.it — tel: 02/4581861

ACCESSORIES

The following objects are present inside the box:

Control unit

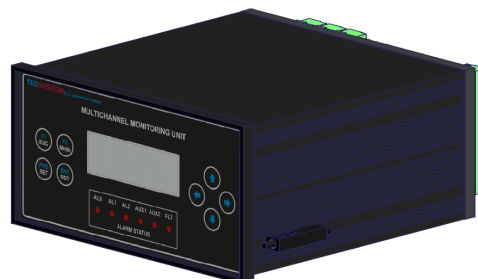

Start Guide and QR code



2 blocks for panel mounting

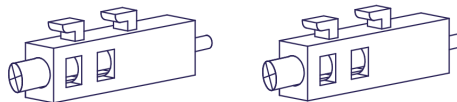

2/3 supply terminal 3 poles pitch 5 Supply/Relay/RS485
Code: 2PL0367 - Screws tightening torque 0.5Nm



1 relay terminal 15 poles pitch 5
Code: 2PL0362 - Screws tightening torque 0.5Nm

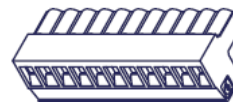

3 sensor terminal 12 poles pitch 5
Code: 2PL0361 - Screws tightening torque 0.5Nm



1MN0030 REV. 0

ATTENTION: Always install the device using the terminals included in the pack.
The use of terminals other than those included with the control unit might cause malfunctions.

TECHNICAL SPECIFICATIONS

T512

POWER SUPPLY

Supply rated values

24-240
Vac-Vcc
50/60HZ

Maximum and minimum supply values

20-270
Vac-Vcc
50/60Hz

Vdc with reversible polarities

●

INPUTS

12 sensors input RTD Pt100 3-wires

●

Connections on removable terminal strips

●

Input channels protected against electromagnetic interference

●

Cable compensation for thermistors

500 m (1 mm²)

OUTPUTS

5 alarm relays (AL0-AL1-AL2-AUX1-AUX2) **SPDT**

●

1 sensor or operating failure (FAULT) **SPDT**

●

Output relays with 5A-250Vca-res COSΦ = 1 contacts

●

RS485 Output Modbus RTU

Optional (*)

DIMENSIONS

192 x 96-mm DIN43700-depth 220mm (terminal block included)

Hole 188 x 92 mm

TESTS AND PERFORMANCE

Construction in compliance with CE regulations

●

Protection from electrical interference EN 61000-4-4

●

Dielectric strength 1500 Vac for 1 min. between output relays and sensors, relays and power supply, power supply and sensors

●

Accuracy ± 1% full scale value, ± 1 digit

●

Ambient operating temperature from -20 ° C to +60 ° C

●

Humidity 90% non-condensing

●

TECHNICAL SPECIFICATIONS

T512

Front polycarbonate IP54

•

Black anodized aluminum housing

•

Absorption 10VA

•

Data memory 10 years minimum

•

Digital linearity of sensors signal

•

Self-diagnostic circuit

•

Protection treatment of the electronic part

Optional

DISPLAY AND DATA MANAGEMENT

1 LCD display with 4 lines of 20 characters to show operative data and program parameters

•

6 LEDs indicated the status of the relay (AL0-AL1-AL2-AUX1-AUX2-FLT)

•

Temperature reading from -40°C to 240°C

•

Alarm settings from 0°C to 240°C

•

3 alarm thresholds for each input

•

Sensor diagnostics (Fcc-Foc)

•

Access to programming through front keyboard

•

Automatic exit from programming after 1 minute's inactivity

•

Selection between channel automatic scanning, hottest channel or manual scanning

•

Storage of maximum temperatures reached by channels and alarm status (memo)

•

Front key to reset the alarms

•

* Only for Modbus inside version

FRONT PANEL

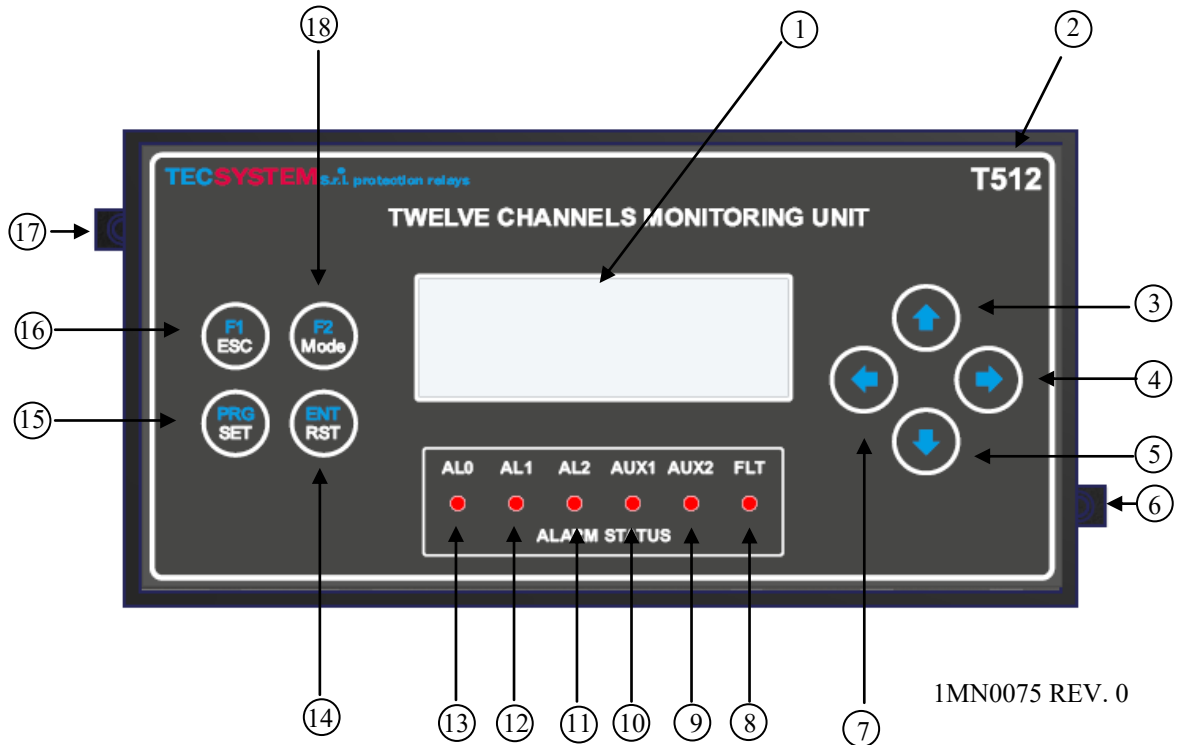

1)	LCD display	10)	AUX1 relay (red) LED
2)	Control unit series	11)	AL2 relay (red) LED
3)	UP key	12)	AL1 relay (red) LED
4)	RIGHT key	13)	AL0 relay (red) LED
5)	DOWN key	14)	Enter / Reset key
6)	Fixing block	15)	Programming / Setting key
7)	LEFT key	16)	ESC / Functions F1 key
8)	Fault relay (red) LED	17)	Fixing block
9)	AUX2 relay (red) LED	18)	Mode / Functions F2 key

NOTE: Due to its own characteristics, the LCD data update speed may be reduced when operating at temperatures lower than 0°C. Anyway this condition doesn't affect the correct working of the monitoring unit.

HOME PAGE

SENSOR TYPE CH

CHANNEL CH

TEMPERATURE CH

TEMPERATURE MAX CH

TEMPERATURE MIN CH

CH 12	PT100	SCAN
TEMP	23 °C	AL0 OFF
Tmax	110 °C	AL1 OFF
Tmin	80 °C	AL2 OFF

SELECTED VIEWING

STATUS AL0

STATUS AL1

STATUS AL2

MOUNTING

Drill a 188 x 92 mm hole in the panel sheet.

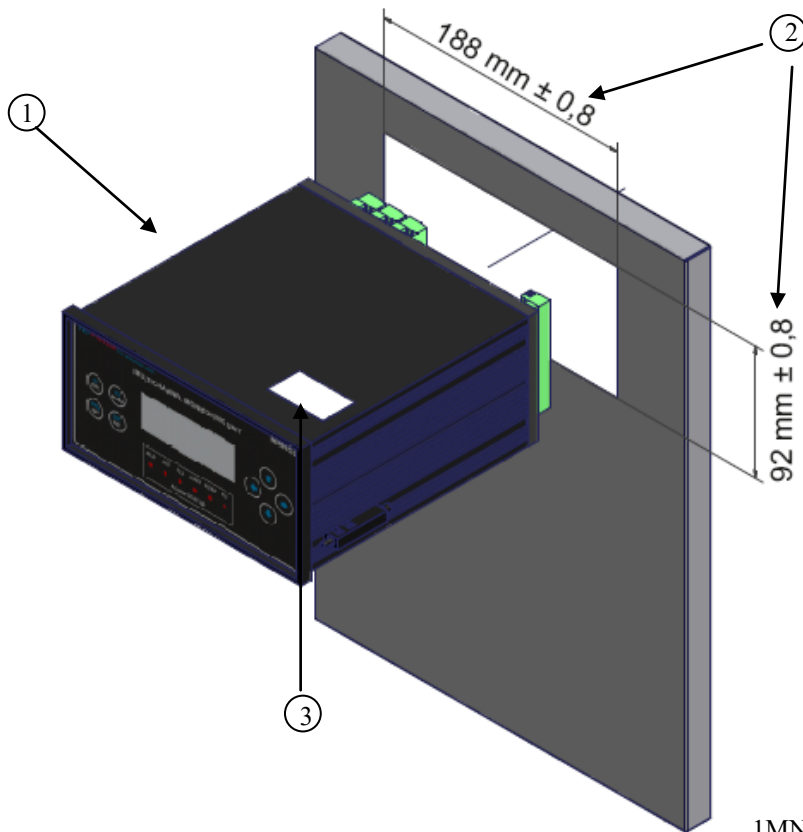

1MN0076 REV. 0

1)	Control unit	2)	Panel hole dimensions (± 0.8 mm tolerance)
3)	Identification label		

Fix the unit securely with the blocks supplied.



1MN0065 REV. 0

1)	Control unit	3)	Fixing screw
2)	Fixing block	4)	Cross-head screwdriver # 1X100mm

Note: Do not install the device in too hot or humid places; low frequency and high intensity vibration can cause damage to the mechanical structure.

ELECTRICAL CONNECTIONS

T512

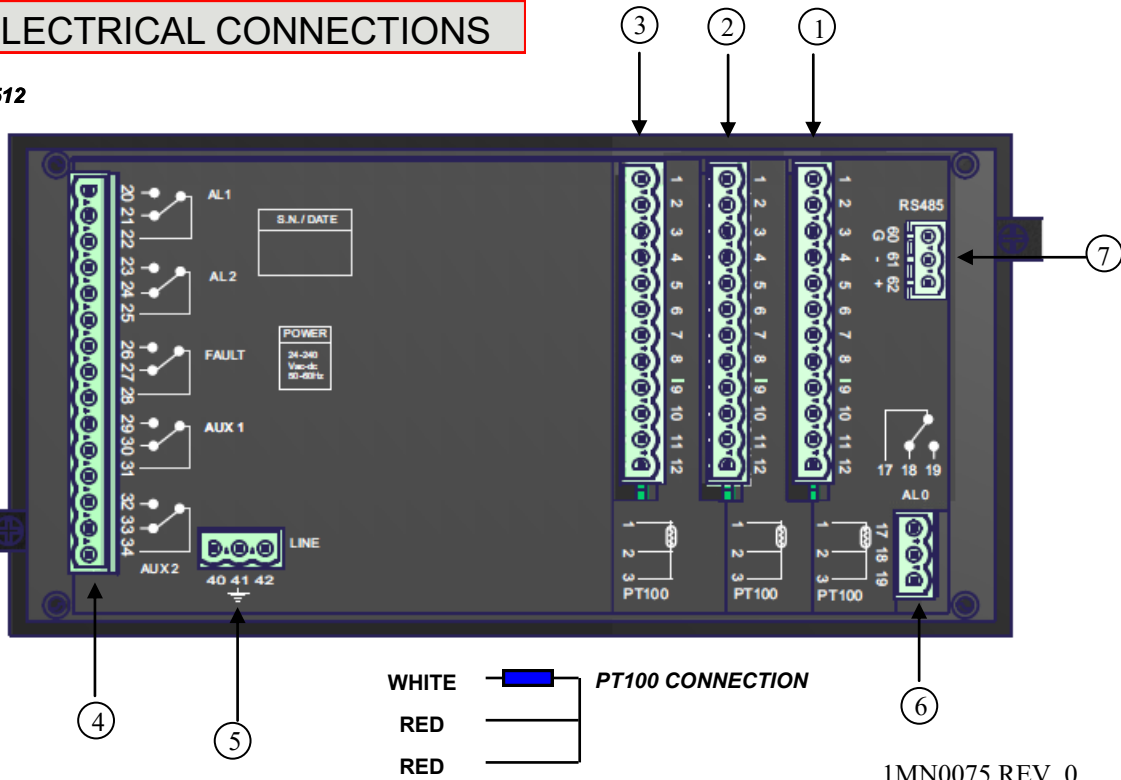

1)	Pt100 sensors (white 1 – red 2 – red 3). Card 1 CH1-CH2-CH3-CH4	5)	Power Supply (LINE 40-41-42) 24 to 240 Vac-Vcc, 50/60Hz
2)	Pt100 sensors (white 1 – red 2 – red 3). Card 2 CH5-CH6-CH7-CH8	6)	AL0 Relay
3)	Sensori Pt100 (white 1 – red 2 – red 3). Card 3 CH9-CH10-CH11-CH12	7)	RS485 (Optional) page 17.
4)	Relays (AL1-AL2-FAULT-AUX1-AUX2)		

Note: when the unit is powered, the FAULT relay switches, contacts 27-28 open (NO) and 26-28 closed (NC), see below image

FAULT CONTACT

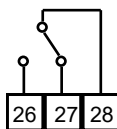

FAULT 27-28 NC: ALARM FAULT OR POWER OFF

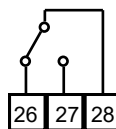

FAULT 26-28 NC: NO FAULT POWER ON

POWER SUPPLY

The T512 control unit has UNIVERSAL power supply, i.e. it can be supplied by 24 to 240 Vac-Vdc, 50/60 Hz irrespectively of polarity in Vdc (terminals 40-42).

This is obtained thanks to the use of a tested power supply unit, newly designed and manufactured, that frees installers from worrying about the correct Vac and Vdc supply.

The ground must always be connected to terminal 41.

When the unit is supplied directly by the secondary of the transformer to protect, it can be burnt out by strong overvoltages. This happens if the main switch is closed and the transformer has no load (blank test).

The above-mentioned problems are much more evident when the 220 Vac voltage is taken directly from the transformer secondary bars and there is a fixed capacitor battery to phase the transformer itself.

If an existing control unit must be replaced with a new one, to guarantee its correct and safe operation, the sensor/ relay/supply connecting terminals **must** be replaced with the new terminals supplied.

ATTENTION: the monitoring unit **must not** be turned off during the starting phase (boot) in order to avoid configuration data loss. In case of configuration problems, enter in **PROGRAMMING** and select the option "factory default" to restore the factory settings.

WIRING NOTES

Connect the terminal on the removable terminal blocks as shown at page 10.

AL0 alarm relay switches when the set threshold value is reached, enabling is available on all channels, see programming step 3 on page 13.

AL1-AL2 / AUX1-AUX2 alarm relays switch when the set threshold values are reached according to the selected intervention logic (Mode Alarm: 1-2-3-4) as shown at page 15.

FAULT relay switches when the monitoring unit is powered on and switches back only when the unit has registered one of the following events:

- Data memory fault (message **DATA LOST / DATA ERROR**) .
- Pt100 sensors fault (**FCC** short-circuited sensor, **FOC** interrupted sensor) .
- Insufficient supply voltage

NOTE: do not connect the FAULT relay to the transformer tripping circuit to avoid system interruptions.

The terminals 40-42 must be connected to the phases of power, while the terminal 41 must be connected to the GROUND of the plant.

NOTE: always disconnect the unit before performing any electrical connection.

PROGRAMMED DATA DIAGNOSTICS

In case of corruption of programmed data, just after switching on, **DATA ERROR** appears on the display with the relevant Fault contact. In this case, for safety reasons, the default parameters are loaded automatically (see pre-set default settings on page 15). Eliminate **DATA ERROR** by pressing **ENT / RST** and run programming to enter the desired values. Finally switch the unit off and back on to check the memory works correctly, if it is damaged **DATA ERROR** will be displayed again (send the control unit to Tecsystem srl for repairs).

In case of failure of the internal memory, **LOST DATA** indication appears with the relevant Fault contact (send the control unit to Tecsystem srl for repairs).

SENSOR CONNECTION

The PT100 sensors must be connected as shown on page 10, each card has 4 Pt100 inputs.

All the cables transferring the Pt100 measurement signals must comply with the following under all circumstances:

- be separated from the power cable
- be made with shielded and twisted conductors
- have a minimum cross section of 0.5 mm²
- be firmly fixed in the terminal
- have tinned or silvered conductors
- shielding must be connected with GROUND of the device together with the ground wire.

NOTE: to install the sensors and signal transferring cable correctly, read the sensor and SCS/SENSOR installation rules manual.

What may happen when installation rules are not complied with.

1) The electrical field propagating from the power line of another circuit, couples capacitively with the conductors (in particular with unshielded cables). The effect of this coupling creates a signal that overlaps the signal transmitted by the nearby conductors, causing incorrect readings.

2) The variations in magnetic flux in the power lines may induce an electromotive force on the signal transferring cables (in particular non-twisted cables), that, being a closed circuit, generates a current. This interference current, multiplied by the circuit resistance, gives a voltage value that overlaps the signal to be transmitted, distorting the sensor measurement.

3) False contacts can alter the signal with the consequent variation in the temperature detected.

In specific cases, when the rules for connecting the Pt100 sensors are not complied with, the following anomalies can occur between the SCS box and the temperature control unit:

- a) incorrect temperature readings, alarms or anomalous tripping
- b) mechanical / electrical fault of the Pt100 sensors
- c) damage to the Pt100 inputs of the control unit.

TECSYSTEM S.r.l. has designed its own special cable to transfer the measurement signals, CEI-compliant, with all the protection requirements provided for: **model CT-ES**.

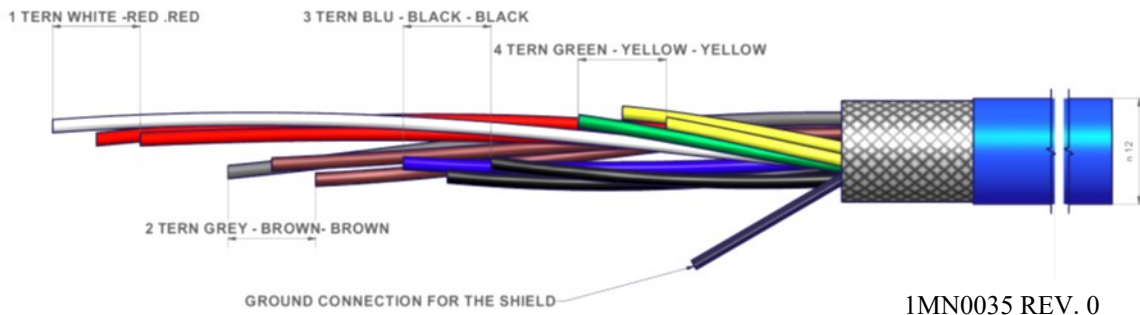

NOTE: the use of cables not complying with the above might cause reading anomalies. It is always important to take into account that any interference on the signal lines might cause anomalies on the Pt100 inputs (CH1-CH2-CH3-CH4-

All "T" series control units have linearity of the sensor signal, with a maximum error of 1% of full scale value.

TEMPERATURE SENSOR DIAGNOSTICS

In case of failure or exceeded full scale value of one of the thermometric sensors installed on the machine to protect, the FAULT relay opens immediately with the relative warning of faulty sensor on the corresponding channel.

Fcc indicates sensor short-circuited or minimum full scale value of the control unit exceeded -40°C

Foc indicates sensor interrupted or maximum full scale value of the control unit exceeded 242°C

To eliminate the message and reset the opening of the Fault contact, it is necessary to check the Pt100 connections and replace the faulty sensor (if any). If the minimum/maximum full scale value has been reached, check that the ambient conditions match the control unit reading.

Note: exceeding the minimum/maximum full scale value can also be caused by interference on the sensor lines; in this case we recommend that you check: the correct installation of the sensors and above all of the extension cable (as stated in the paragraph MEASUREMENT SIGNAL TRANSFER)

TEMPERATURE DIAGNOSTICS

When one of the temperature sensors senses a temperature 1°C higher than the alarm threshold, 5 seconds later the **ALARM** relay switches and the AL/AUX LED turns on: the page of the channel which generated the alarm displays ON near the passed threshold (**AL0, AL1-AL2 or AUX1-AUX2**).

When the taken temperature returns to equal or lower values than the set limit for relay switching, these relays de-energize with consequent turning off of relevant LED.

DISPLAY MODE

Pressing the **MODE** key, the display modes can be set:

- **SCAN:** the monitoring unit displays a sequence of all activated channels (each 2 seconds)
- **HIGH:** the monitoring unit automatically displays the hottest channel
- **MAN:** manual reading of the channels temperature using the up/down ▲▼ keys
- **MEMO:** the monitoring unit displays the alarm log updated to the last reset. Select the channels through the ▲ ▼ keys and press RESET to reset the values.

USE AND WORKING OF T512 CONTROL UNIT

The control unit T512 is composed by 3 interchangeable Pt100 cards.

PROGRAMMING SEQUENCE

T512

PROGRAMMING MENU

Introduction page to the programming parameters.

FUNCTION DESCRIPTION	DISPLAY PAGE
<p>Press and hold the PRG / SET key for 7 seconds until the PROGRAMMING MENU page is displayed. Press the ▲ ▼ keys and place the cursor → on the function desired. Press the ENT / RST key to confirm your choice.</p>	<div style="border: 1px solid black; padding: 5px;"> <p>PROGRAMMING MENU</p> <p>1 → Channels setting</p> <p>2 T512 Setting</p> <p>3 Factory Default</p> </div>

PROGRAMMING OF CHANNELS SETTING PAGE

Selecting **Channels setting**, the page allowing to set the programming parameters for each channel is shown.

STEP	FUNCTION DESCRIPTION	DISPLAY PAGE
1	<p>The cursor → is positioned at the first available channel. Press the ▲ ▼ keys to select the page programming of other channels. Press the ▶ key to proceed to step 2.</p>	<div style="border: 1px solid black; padding: 5px;"> <p>CH <u>12</u> ON PT100 SET</p> <p>AL0 ON AL0 60°C</p> <p>Rel AL >AL1 90°C</p> <p>Mode 1 >AL2 119°C</p> </div>
2	<p>Press the ▲ ▼ keys to enable (ON) or disable (OFF) the channel. Press the ▶ key to proceed to step 3.</p>	<div style="border: 1px solid black; padding: 5px;"> <p>CH <u>12 ON</u> PT100 SET</p> <p>AL0 ON AL0 60°C</p> <p>Rel AL >AL1 90°C</p> <p>Mode 1 >AL2 119°C</p> </div>
3	<p>Press the ▲ ▼ keys to enable (ON) or disable (OFF) the Alarm AL0 threshold. Press the ▶ key to proceed to step 4 (if AL0 ON) or to step 5 if (AL0 OFF).</p>	<div style="border: 1px solid black; padding: 5px;"> <p>CH 12 ON PT100 SET</p> <p>AL0 <u>ON</u> AL0 60°C</p> <p>Rel AL >AL1 90°C</p> <p>Mode 1 >AL2 119°C</p> </div>
4	<p>Press the ▲ ▼ keys to set the Alarm AL0 threshold. Press the ▶ key to proceed to step 5.</p>	<div style="border: 1px solid black; padding: 5px;"> <p>CH 12 ON PT100 SET</p> <p>AL0 ON AL0 <u>60°C</u></p> <p>Rel AL >AL1 90°C</p> <p>Mode 1 >AL2 119°C</p> </div>
5	<p>Press ▲ ▼ keys to select the relay set (AL1-AL2 or AUX1-AUX2) where 1 and 2 thresholds must be connected. Press ▶ key to proceed to step 6.</p>	<div style="border: 1px solid black; padding: 5px;"> <p>CH 12 ON PT100 SET</p> <p>AL0 ON AL0 60°C</p> <p>Rel <u>AL</u> >AL1 90°C</p> <p>Mode 1 >AL2 119°C</p> </div>

6	<p>Press the ▲ ▼ keys to set the Alarm AL1 (or AUX1) threshold.</p> <p>Press the ► key to proceed to step 7.</p>	<p>CH 12 ON PT100 SET AL0 ON AL0 60°C Rel AL >AL1 90°C Mode 1 >AL2 119°C</p>
7	<p>Press ▲ ▼ keys to set the AL1 (or AUX1) relay intervention logic when the set threshold is reached.</p> <p>Mode 1 (>): intervention for T°>threshold Mode 2 (<): intervention for T°<threshold Mode 3 (><): intervention for T°<threshold just exceeded</p> <p>Mode 4 (><): same logic as mode 3, but with storage in MEMO page only for the first alarm occurred among AL1, AL2, AUX1, AUX2</p> <p>Press ► key to proceed to step 8.</p>	<p>CH 12 ON PT100 SET AL0 ON AL0 60°C Rel AL >AL1 90°C Mode <u>1</u> >AL2 119°C</p>
8	<p>Press the ▲ ▼ keys to set the threshold alarm AL2 (or AUX2).</p> <p>Press F2 to return to the page PROGRAMMING MENU</p>	<p>CH 12 ON PT100 SET AL0 ON AL0 60°C Rel AL >AL1 90°C Mode 1 >AL2 119°C</p>

NOTES:

- Press the ◀ key to return to the previous step.
- Press the F2 key to return to the **PROGRAMMING MENU**.
- Press the F1 key to exit the programming mode if you do not need to set other parameters.
- The value of alarm threshold 1 cannot be higher than the threshold value of alarm 2.

PROGRAMMING T512 PAGE SETTING

Selecting T512 SETTING it appears the page that allow you to load the T512 base operating settings.

STEP	FUNCTION DESCRIPTION	DISPLAY PAGE
1	<p>The cursor → is placed near the setting on which you want to operate</p> <p>Press ▲ ▼ keys to change the selection</p> <p>Press ENTER key to confirm the choice.</p> <p>NOTE: several optional selections may depend on the unit model.</p>	<p>T512 SETTING 1→Display Contrast </p>
2	<p>By selecting Display Contrast the page to adjust the display contrast is shown.</p> <p>Press ▲ ▼ keys to modify it.</p>	<p>CONTRAST SETTING</p> <p>■■■■■■■ 0123456789</p>

NOTES:

- Press the F2 key to return to the **T512 SETTING**
- Press the F1 key to exit the programming mode if you do not need to set other parameters.

FACTORY DEFAULT SELECTION

Selecting **FACTORY DEFAULT** the factory settings of the control unit can be restored.

Attention, pressing (yes) all programmed data will be erased and replaced with the default ones.

STEP	FUNCTION DESCRIPTION	DISPLAY PAGE
1	Press the ▲ ▼ keys to select yes or no. Press the ENTER key to confirm your choice. Setting YES after selecting the default data, the control unit resets and returns to the display on the screen "Temperatures".	<div style="border: 1px solid black; padding: 10px;"> FACTORY DEFAULT Reset data? → Press Enter </div>

NOTES:

Press the **F2** key to return to the **PROGRAMMING MENU**.

Press the **F1** key to exit the programming mode and return to display mode temperatures.

FACTORY DEFAULT SETTINGS

The selection of the factory default includes:

- All 12 channels enable "ON".
- SCAN mode setting.
- For the storage of temperature alarms and configuration, see example screen on the right.

ALARM AND CONFIGURATION

CH 12 ON	PT100 SET
AL0 ON	AL0 60°C
Rel AL	>AL1 90°C
Mode 1	>AL2 119°C

RELAYS LOGIC (AL/AUX).

T512 PROGRAMMING ALARMS

INDICATION OF OPTIONAL PROGRAM STEPS

AL1= 90°C - AL2 = 119°C

CH 12 ON	PT100 SET
AL0 ON	AL0 60°C
Rel AL	>AL1 90°C
Mode <u>1</u>	>AL2 119°C

STATUS ALARM L1 L2

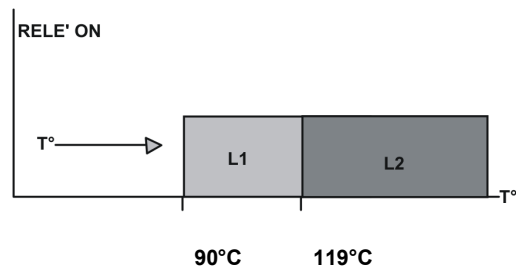

SWITCHING OVER THE PRESET AL1 and AL2 VALUES

CH 12 ON	PT100 SET
AL0 ON	AL0 60°C
Rel AL	>AL1 90°C
Mode <u>2</u>	>AL2 119°C

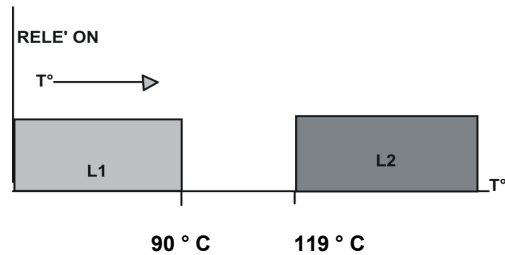

SWITCHING BELOW THE PRESET AL1 VALUE SWITCHING OVER THE PRESET AL2 VALUE

CH 12 ON	PT100 SET
AL0 ON	AL0 60°C
Rel AL	>AL1 90°C
Mode <u>3</u>	>AL2 119°C

SWITCHING OVER THE PRESET AL2 VALUE

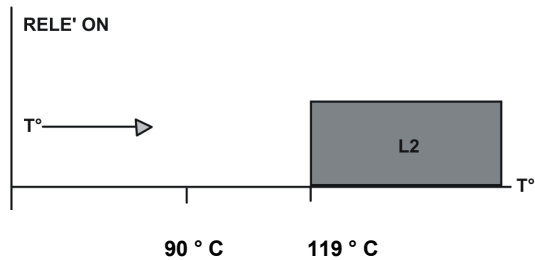

SWITCHING IF THE VALUE RETURNS BELOW AL1 SET VALUE

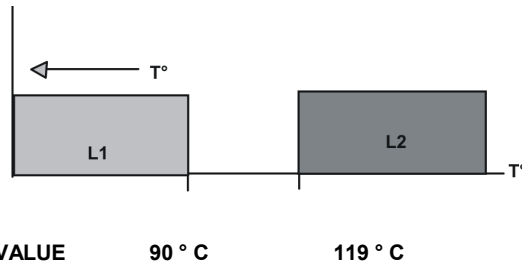

MODE 4: In mode 4, the alarm intervention logic is exactly the same as mode 3. The difference lies in the all-time alarm display page (MEMO page): when in mode 4 only the first intervention of one of the following alarms is stored and displayed :

- AL1 or AUX1 (temperature lower than the minimum threshold, with threshold already exceeded)
- AL2 or AUX2 (temperature higher than the maximum threshold)

In this case, from the MODE page the first channel triggering the alarm signal can be unequivocally identified. After the first alarm, the all-time alarm storage in MEMO page is inhibited, but not the interventions and the signal in SCAN, MAN, HIGH pages. To reset the storage inhibition, press **RESET** key in MEMO page for all the channels that work in mode 4.

On the contrary, AL0 and FAULT don't cause the alarm inhibition. Once it is inhibited, due to the switching of AL1, AL2, AUX1, AUX2, data are not stored.

ATTENTION: if mode 4 is not reset on all the channels, the monitoring unit will not be able to identify the first alarm occurred on AL1, AL2, AUX1, AUX2.

NOTE: the alarms are stored in the log after approximately 5 seconds after the triggering of the alarm. If the monitoring unit is turned off before these 5 seconds, the alarm is not stored in the log.



ATTENTION:

We recommend you to check the programming before starting to use the control unit.

The default parameters set by TECSYSTEM might not suit your requirements.

Programming the device is the end user's responsibility: the set alarm thresholds and the enabled functions described in this manual must be checked (by a specialized technician) referring them to the application and system characteristics on which the control unit is installed.

OPZIONE MODBUS

T512 Modbus module allows to transfer data on a RS485 network with ModBus RTU protocol.

OPERATING NOTES

For a correct working of Modbus it is necessary to load the RS485 network setup parameters: address, baud rate, parity bit (please refer to Modbus parameter programming at page 19).

The serial communication of the temperature control monitoring unit is active only when the T512 is in monitoring mode and not in programming mode.

DATA TRANSMISSION ON MODBUS NETWORK

Modbus output allows to read all the data shown in the registers 1-12 and to write the ones shown in the rewritable registers: 49-60 for AL0 thresholds, 73-84 for AL1 thresholds, 97-108 for AL2 thresholds, 123- (REMOTE RESET)

RS485 ELECTRICAL CONNECTIONS

As far as the signal cable to be used in order to ensure the correct network operation is concerned, we recommend you follow the provisions of the EIA RS485 standard which suggests using a 24AWG twisted pair.

The twisted pair that connects units in RS485 might need a 120 ohm end resistor on the last unit of the series.

Connect the twisted pair paying attention to polarities and lay the network avoiding to make sharp bends or ring windings in order not to modify line impedance.

Connection RS485 terminal 61 (-) 62 (+). If necessary, the GND terminal (60) for grounding is also available.

Always position the RS485 twisted pair far from power cables.

DATA FRAME

The frame in asynchronous transmission consists of: 1 start bit, 8 data bits, 1 parity bit (even or odd, if the parity has been set) and 1 stop bit. Admitted baud rates are: 2400, 4800, 9600 and 19200.

If not otherwise specified, the word length (DATA) is 16 bits.

DATA PACKET

A complete sequence of request/answer consists of the following:

Master request:
SLAVE ADDRESS - 1 byte
FUNCTION CODE - 1 byte
DATA - variable, it depends by function code
CRC - 2 bytes

Slave request:
SLAVE ADDRESS - 1 byte
FUNCTION CODE - 1 byte
DATA - variable, it depends by function code
CRC - 2 bytes

FUNCTION CODE

The T512 ModBus module supports the following function codes:

3₍₁₀₎: - holding register reading

16₍₁₀₎: - register multiple writing

If MODBUS receives a message and a CRC error is detected, no answer is given.

CODE 3₍₁₀₎

Request:

Slave address, code 3₍₁₀₎, Starting address HI, Starting address LO, Number of Point HI, Number of Point LO, Crc LO, Crc HI.

Answer:

Slave address, code 3₍₁₀₎, Byte count, Data HI, Data LO....., Crc LO, Crc HI.

CODE 16₍₁₀₎

Request:

Slave address, code 16₍₁₀₎, Starting address HI, Starting address LO, Number of Point HI, Number of Point LO, Byte count, Data HI, Data LO....., Crc LO, Crc HI.

Answer:

Slave address, code 16₍₁₀₎, Starting address HI, Starting address LO, Number of Register HI, Number of register LO, Crc LO, Crc HI.

The writable registers are the ones containing the following data: AL0, AL1, AL2.

Therefore the possible starting address are: 49-60 for AL0 thresholds, 73-84 for AL1 thresholds, 97-108 for AL2 thresholds. Number of Point LO parameter can be loaded from 1 to 24 (max).

If a writing request is sent to an address different from the above mentioned ones, MODBUS will answer with a 02 error code (wrong data address).

If a writing request for a number higher than 24 registers is sent (Number of point LO), MODBUS won't be able to accept the request and it won't give any answer. Therefore the query will go in "timeout".

NOTES FOR REMOTE PROGRAMMING

Also in the remote programming phase via ModBus you must take into consideration that AL1 thresholds must be lower than AL2 thresholds.

In case you try to set these thresholds incorrectly, the control unit will not proceed with the programming and storage of data, therefore in subsequent readings will read the data from the previous schedule. ERROR PROGRAMMING message will be displayed for 2 seconds.

After having sent a request for writing the control unit will take a time of about 1 to store the data in eeprom, during the storage. To confirm the display will show REMOTE PROGRAMMING message.

ERROR CODES (exception code).

In case of a wrong request, T512 will answer with modified codes and codified errors according to the following:

- 1: - Unsupported function code
- 2: - Wrong data address
- 3: - Wrong data (for instance length)

POLLING FREQUENCY

We recommend polling frequencies equal to or greater than 1 second are adopted. More frequent polling can overload the system without any benefit whatsoever. In multi-device RS485 lines, interrogated in sequence, it may be useful to enter a delay between polls in relation to: the number of connected devices, the communication speed and the number of read registers.

CRC CALCULATION

The protocol includes 2 CRC-16 bytes in each transmission. The characteristic polynomial (1100000000000101B) is used for the calculation and the result is "hung" at the end of the packet. The polynomial is used in reverse order with the most significant bit suppressed because useless for the purpose of the calculation.

PARAMETER DESCRIPTION

A - 16-bit registers
AL - A low part
AH - A high part
i,j, - METERS
(+) - EXCLUSIVE OR
Di - Datum of the «i»th of the packet
N - number of bytes in the packet excluded 2 of the CRC
G - Polynomial : 1010-0000-0000-0001
shr - shift to the right

ALGORITHM

0xFFFF -> A
0 -> i
0 -> j
Di (+) AL -> AL
j +1 -> j
shr A
if carry then G (+) A -> A
if NOT j=8 then go to 5
i +1 -> i
if NOT i = N then go to 3
11) A -> in CRC (the result is in order L,H)

MODBUS PARAMETER PROGRAMMING (only for MODBUS version)

Introduction page to the monitoring unit programming parameters

FUNCTION DESCRIPTION	PAGE DISPLAY
Keep pressed PRG/SET key for 7 seconds until PROGRAMMING MENU page appears. Press ▲ ▼ keys and move the cursor → on T512 Setting function. Press ENT/RST key to confirm the choice.	<p style="text-align: center;">PROGRAMMING MENU</p> <p style="text-align: center;">1 Channels setting</p> <p style="text-align: center;">2→ T512 Setting</p>

STEP	FUNCTION DESCRIPTION	PAGE DISPLAY
1	Position cursor → on Modbus setting. Press ▲ ▼ keys to change the selection. Press ENTER key to confirm the choice.	<p style="text-align: center;">T512 SETTING</p> <p style="text-align: center;">1 Display Contrast</p> <p style="text-align: center;">2→ Modbus setting</p> <p style="text-align: center;">3 Factory default</p>
2	Selecting Modbus Setting the page allowing to load the Modbus parameter setting is displayed. Press ◀ ▶ keys to select the parameter to modify (ADR= address, Bdr= Baud rate, PAR= parity bit). Press ▲ ▼ keys to modify it.	<p style="text-align: center;">MODBUS SETTING</p> <p style="text-align: center;">ADR → 01</p> <p style="text-align: center;">Bdr 9600</p> <p style="text-align: center;">PAR NONE</p>

NOTES:

Press **F2** key to return to T512 SETTING page.

Press **F1** key to leave the programming if you don't need to load other parameters.

Selecting T512 SETTING, the page allowing to load the operational settings for the base unit T512 is displayed.

MODBUS TEMPERATURE MAPPING

ADR_HI	ADR_LO	DATA_HI	DATA_LO	PRIMARY TABLES
0	1	TEMP_HI_CH1	TEMP_LO_CH1	HOLDING REGISTER
0	2	TEMP_HI_CH2	TEMP_LO_CH2	HOLDING REGISTER
0	3	TEMP_HI_CH3	TEMP_LO_CH3	HOLDING REGISTER
0	4	TEMP_HI_CH4	TEMP_LO_CH4	HOLDING REGISTER
0	5	TEMP_HI_CH5	TEMP_LO_CH5	HOLDING REGISTER
0	6	TEMP_HI_CH6	TEMP_LO_CH6	HOLDING REGISTER
0	7	TEMP_HI_CH7	TEMP_LO_CH7	HOLDING REGISTER
0	8	TEMP_HI_CH8	TEMP_LO_CH8	HOLDING REGISTER
0	9	TEMP_HI_CH9	TEMP_LO_CH9	HOLDING REGISTER
0	10	TEMP_HI_CH10	TEMP_LO_CH10	HOLDING REGISTER
0	11	TEMP_HI_CH11	TEMP_LO_CH11	HOLDING REGISTER
0	12	TEMP_HI_CH12	TEMP_LO_CH12	HOLDING REGISTER
0	From 13 to 24	FREE	FREE	FREE

Registers from N.1 to N.12 contain the values relevant to each channel.

In order to manage also the reading of the negative quantities and to get the correctly shifter item you have to subtract an offset of 160 to the read value.

To the Fault Foc (fault for "open" sensor ") and Fcc (fault for short circuited sensor) conditions, correspond the following messages (which have not a numerical meaning in terms of temperature):

FOC: 1024 (0x2800 hex)

FCC: 10 (0x000A hex)

CHANNEL STATE AND SETTING MAPPING

ADR_HI	ADR_LO	DATA_HI	DATA_LO	PRIMARY TABLES
0	25	STATO_AL_CH1	SETTING_CH1	HOLDING REGISTER
0	26	STATO_AL_CH2	SETTING_CH2	HOLDING REGISTER
0	27	STATO_AL_CH3	SETTING_CH3	HOLDING REGISTER
0	28	STATO_AL_CH4	SETTING_CH4	HOLDING REGISTER
0	29	STATO_AL_CH5	SETTING_CH5	HOLDING REGISTER
0	30	STATO_AL_CH6	SETTING_CH6	HOLDING REGISTER
0	31	STATO_AL_CH7	SETTING_CH7	HOLDING REGISTER
0	32	STATO_AL_CH8	SETTING_CH8	HOLDING REGISTER
0	33	STATO_AL_CH9	SETTING_CH9	HOLDING REGISTER
0	34	STATO_AL_CH10	SETTING_CH10	HOLDING REGISTER
0	35	STATO_AL_CH11	SETTING_CH11	HOLDING REGISTER
0	36	STATO_AL_CH12	SETTING_CH12	HOLDING REGISTER
0	From 37 to 48	FREE	FREE	FREE

Registers from N.25 to N.36 contain the state of the channels in the higher side and the setting in the lower side.

STATO_AL_CH n (0 = off, 1 = on)

bit 0: AL0
 bit 1: AL1
 bit 2: AL2
 bit 3: AUX1
 bit 4: AUX2
 bit 5: FAULT
 bit 6: (free)
 bit 7: (free)

SETTING_CH n (0 = off, 1 = on)

bit 0: Ch enabled
 bit 1: AL0 enabled
 bit 2: AL1-AL2 relays enabled
 bit 3: AUX1-AUX2 relays enabled
 bit 4: Present channel (connected card)
 bit 5: (free)
 bit 6: (free)
 bit 7: Modified channel (system data)

STATO_AL_CH n								SETTING_CH n							
bit7	bit6	bit5	bit4	bit3	bit2	bit1	bit0	bit7	bit6	bit5	bit4	bit3	bit2	bit1	bit0
(free)	(free)	FAULT	AUX2	AUX1	AL2	AL1	AL0	Ch modified	(free)	(free)	Ch present	AUX1-2 enabled	AL1-2 enabled	AL0 enabled	Ch enabled

AL0 MAPPING

ADR_HI	ADR_LO	DATA_HI	DATA_LO	PRIMARY TABLES
0	49	AL0_HI_CH1	AL0_LO_CH1	HOLDING REGISTER
0	50	AL0_HI_CH2	AL0_LO_CH2	HOLDING REGISTER
0	51	AL0_HI_CH3	AL0_LO_CH3	HOLDING REGISTER
0	52	AL0_HI_CH4	AL0_LO_CH4	HOLDING REGISTER
0	53	AL0_HI_CH5	AL0_LO_CH5	HOLDING REGISTER
0	54	AL0_HI_CH6	AL0_LO_CH6	HOLDING REGISTER
0	55	AL0_HI_CH7	AL0_LO_CH7	HOLDING REGISTER
0	56	AL0_HI_CH8	AL0_LO_CH8	HOLDING REGISTER
0	57	AL0_HI_CH9	AL0_LO_CH9	HOLDING REGISTER
0	58	AL0_HI_CH10	AL0_LO_CH10	HOLDING REGISTER
0	59	AL0_HI_CH11	AL0_LO_CH11	HOLDING REGISTER
0	60	AL0_HI_CH12	AL0_LO_CH12	HOLDING REGISTER
0	From 61 to 72	FREE	FREE	FREE

Registers from N.49 to N.60 contain the AL0 thresholds programmed for each channel. In order to manage also the reading of the negative values is necessary to subtract an offset of 160 to calculate the correct data.

AL1 MAPPING

ADR_HI	ADR_LO	DATA_HI	DATA_LO	PRIMARY TABLES
0	73	AL1_HI_CH1	AL1_LO_CH1	HOLDING REGISTER
0	74	AL1_HI_CH2	AL1_LO_CH2	HOLDING REGISTER
0	75	AL1_HI_CH3	AL1_LO_CH3	HOLDING REGISTER
0	76	AL1_HI_CH4	AL1_LO_CH4	HOLDING REGISTER
0	77	AL1_HI_CH5	AL1_LO_CH5	HOLDING REGISTER
0	78	AL1_HI_CH6	AL1_LO_CH6	HOLDING REGISTER
0	79	AL1_HI_CH7	AL1_LO_CH7	HOLDING REGISTER
0	80	AL1_HI_CH8	AL1_LO_CH8	HOLDING REGISTER
0	81	AL1_HI_CH9	AL1_LO_CH9	HOLDING REGISTER
0	82	AL1_HI_CH10	AL1_LO_CH10	HOLDING REGISTER
0	83	AL1_HI_CH11	AL1_LO_CH11	HOLDING REGISTER
0	84	AL1_HI_CH12	AL1_LO_CH12	HOLDING REGISTER
0	From 85 to 96	FREE	FREE	FREE

Registers from N.73 to N.84 contain the AL1 thresholds programmed for each channel. In order to manage also the reading of the negative values is necessary to subtract an offset of 160 to calculate the correct data.

AL2 MAPPING

ADR_HI	ADR_LO	DATA_HI	DATA_LO	PRIMARY TABLES
0	97	AL2_HI_CH1	AL2_LO_CH1	HOLDING REGISTER
0	98	AL2_HI_CH2	AL2_LO_CH2	HOLDING REGISTER
0	99	AL2_HI_CH3	AL2_LO_CH3	HOLDING REGISTER
0	100	AL2_HI_CH4	AL2_LO_CH4	HOLDING REGISTER
0	101	AL2_HI_CH5	AL2_LO_CH5	HOLDING REGISTER
0	102	AL2_HI_CH6	AL2_LO_CH6	HOLDING REGISTER
0	103	AL2_HI_CH7	AL2_LO_CH7	HOLDING REGISTER
0	104	AL2_HI_CH8	AL2_LO_CH8	HOLDING REGISTER
0	105	AL2_HI_CH9	AL2_LO_CH9	HOLDING REGISTER
0	106	AL2_HI_CH10	AL2_LO_CH10	HOLDING REGISTER
0	107	AL2_HI_CH11	AL2_LO_CH11	HOLDING REGISTER
0	108	AL2_HI_CH12	AL2_LO_CH12	HOLDING REGISTER
0	From 109 to 120	FREE	FREE	FREE

Registers from N.97 to N.108 contain the AL2 thresholds programmed for each channel. In order to manage also the reading of the negative values is necessary to subtract an offset of 160 to calculate the correct data.

MAPPING 121 → 125.

ADR_HI	ADR_LO	DATA_HI	DATA_LO	REGISTRO
0	121	ADR MODBUS	BDR	WORD_120
0	122	PARITY	free	WORD_121
0	123	COMMAND_HI	COMMAND_LO	WORD_122
0	124	free	free	WORD_123
0	125	free	free	WORD_124

By sending to the register 123 a writing command (CODE₁₆) containing 00000000 – 00000001 word, a remote reset procedure is activated, whose aim is to reset the log of the alarms and the min. and max. recorded temperatures stored in the unit. REMOTE RESET message confirms that the command has been executed.

At the moment the registers 122_LO and registers from 24 to 125 are not used.

ADR MODBUS								BDR							
bit7	bit6	bit5	bit4	bit3	bit2	bit1	bit0	bit7	bit6	bit5	bit4	bit3	bit2	bit1	bit0
adr_07	adr_06	adr_05	adr_04	adr_03	adr_02	adr_01	adr_01	0	0	0	0	0	0	BDR1	BDR0

Available ADR MODBUS:

adr_07...adr_00 = from 00000000 (0) to 11111111 (255)

BDR available values:

BDR1 BDR0 = 00	2400 B/S
BDR1 BDR0 = 01	4800 B/S
BDR1 BDR0 = 10	9600 B/S
BDR1 BDR0 = 11	19200 B/S

bit2...bit7 = not used

PARITY							
bit7	bit6	bit5	bit4	bit3	bit2	bit1	bit0
0	0	0	0	0	0	par_1	par_2

PARITY available values:

par_1 par_2 = 00	NONE
par_1 par_2 = 01	EVEN
par_1 par_2 = 10	ODD

bit2...bit7 = not used

WARRANTY CONDITIONS

The Product purchased is covered by the manufacturer's or seller's warranty at the terms and conditions set forth in the "Tecsystem s.r.l.'s General Conditions of Sale", available at www.tecssystem.it and / or in the purchase agreement.

The warranty is considered valid only when the product is damaged by causes attributable to TECSYSTEM srl, such as manufacturing or components defects.

The warranty is invalid if the Product proves to have been tampered with / modified, incorrectly connected, because of voltages outside the limits, non-compliance with the assembly and use technical data, as described in this instruction manual.

The warranty is always ex Corsico as stated in the "General Conditions of Sale".

TROUBLESHOOTING	CAUSES AND SOLUTIONS
The control unit does not switch on and the supply to terminals 40-42 is correct.	Check that: the connector is correctly inserted into its housing, the wires are tightened, there is no evidence of burning on the connectors. Disconnect the power supply, carry out the above and reconnect.
One of the channels is in FAULT due to FOC/FCC	Check the connections of the Pt100 sensors, check the instructions given in the paragraphs: sensor connection on page 11.
When turning on, the display shows "DATA ERROR" or "DATA LOST"	Strong interference damaged the stored data. See the paragraph Programmed data diagnostics on page 11.
All the Pt100 sensors are in FCC.	Incorrect sensor connection, the terminal block has been inserted upside down. <i>Check the connections and the terminal board.</i>
The temperature shown by one or more channels is wrong.	Contact the <i>TECSYSTEM Technical Department.</i>
Sudden trip of the main switch. The temperature is on standard levels. Just one channel has caused the trip.	Verify through MEMO function possible defective sensors. Replace the sensor. Check the measuring signal support terminal boards.
Contact <i>TECSYSTEM Technical Department if the problem persists.</i>	

EQUIPMENT DISPOSAL

European directives 2012/19/EC (WEEE) and 2011/65/EC (RoHS) have been approved to reduce electrical and electronic waste and promote the recycling and reuse of the materials and components of said equipment, cutting down on the disposal of the residues and harmful components of electrical and electronic materials.



All the electrical and electronic equipment supplied after 13 August 2005 is marked with this symbol, pursuant to European directive 2002/96/EEC on electrical and electronic waste (WEEE). Any electrical or electronic equipment marked with this symbol must be disposed of separately from normal domestic waste.

Returning used electrical devices: contact TECSYSTEM or your TECSYSTEM agent for information on the correct disposal of the devices.

TECSYSTEM is aware of the impact its products have on the environment and asks its customers active support in the correct and environmentally-friendly disposal of its devices.

UL SPECIFICATION AND RATINGS

INPUT SUPPLY	24 – 240 Vac/ Vdc (20-270Vac/Vdc) 50/60 Hz, 20VA max
ALARM OUTPUTS RELAYS	6 x 5A 250VAC-res COS=1 resistive
INPUT Pt100	MAX 12 x RTD Pt100 3 wires
OPTIONAL	RS485 output

USEFUL CONTACTS

TECHNICAL INFORMATION: ufficiotecnico@tecsystem.it

COMMERCIAL INFORMATION: info@tecsystem.it

