

ø16

A6 Series Miniature Control Units

Light duty type in short 22mm body length.

- Features IDEC's original mechanism for snap-action switching. Suitable for a wide variety of office and factory applications.
- The LED lamp contains a current-limiting resistor and a diode for protection against reverse connection.
- 16-mm mounting holes
- Available in enclosed (IP40) and waterproof (IP65), and oiltight types.
- UL recognized, CSA certified, and EN compliant



Contact Ratings (Contact Block)

Rated Insulation Voltage		250V			
Rated Thermal Current		3A			
Operating Voltage (AC/DC)		12V	24V	110V	220V
AC 50/60 Hz	Resistive Load	—	—	1.0A	0.5A
	Inductive Load	—	—	0.7A	0.5A
DC	Resistive Load	1.0A	1.0A	0.2A	—
	Inductive Load	0.7A	0.7A	0.5A	—
Contact Material		Gold-clad silver			

- Minimum applicable load: 5V AC/DC, 1 mA (applicable range may vary with operating conditions and load types)

Weight

Weight (approx.)	AL6M-M24:	8g
	AL6M-P4:	6g
	AB6M-M2:	7g
	AB6M-V2R:	9g
	AS6M-2Y2:	9g
	AS6M-2KT2A:	21g

Specifications





Operating Temperature		-25 to +55°C (no freezing)
Storage Temperature		-30 to +80°
Operating Humidity		45 to 85% RH (no condensation)
Contact Resistance		50 mΩ maximum (initial value)
Insulation Resistance		100 MΩ minimum (500V DC megger)
Dielectric Strength	Switch Unit	Between live and dead metal parts: 2,000V AC, 1 minute Between terminals of different poles: 2,000V AC, 1 minute Between terminals of the same pole: 1,000V AC, 1 minute Between contact and lamp terminals: 1,500V AC, 1 minute
	Illumination Unit	Between live part and ground: 2,000V AC, 1 minute
Vibration Resistance		Operating extremes: 5 to 55 Hz, amplitude 0.75 mm
Shock Resistance		Damage limits: 500 m/s ² (50G) Operating extremes: 200 m/s ² (20G)
Mechanical Durability (minimum operations)		Momentary: 1,000,000 operations Maintained: 100,000 operations Pushlock Turn Reset: 100,000 operations Selector Switch: 250,000 operations Key Selector Switch: 250,000 operations
Electrical Durability (minimum operations)		Other than Maintained: 100,000 operations Maintained: 50,000 operations (Switching frequency 1200 operations/h)
Degree of Protection		Enclosed (IP40) Waterproof, dust-tight (IP65)

LED Lamp Ratings (LATD Type)

Type No.	LATD-5②	LATD-1②	LATD-2②
Lamp Base	Exclusive for A series control units		
Voltage Range	5V DC ±5%	12V AC/DC ±10%	24V AC/DC ±10%
Rated Voltage	5V DC	12V AC/DC	24V AC/DC
Current Draw	AC	—	9 mA
	DC	8 mA	8 mA
Color Code ②	A (amber), G (green), JW (pure white), R (red), S (blue), W (white), Y (yellow)		
Lamp Base Color	Same as illumination color		
Voltage Marking	Die stamped on the base		
Life (reference value)	Approx. 50,000 hours (The luminance is reduced to 50% the initial intensity when used on complete DC.)		
Internal Circuit			

- Specify a color code in place of ② in the Type No.
A (amber), G (green), JW (pure white), R (red), S (blue), W (white), Y (yellow)









AL6 LED Illuminated Pushbuttons

Shape	Operation Type	Operating Voltage	Contact	Type No.		② Lens Color Code
				IP40	IP65	
Round AL6M   Marking plate size: ø13.7 mm Engraving area: ø12 mm (Depth: 0.5 mm max.)	Momentary	5V DC ±5%	SPDT	AL6M-M11②	AL6M-M11P②	Specify a color code in place of ② in the Type No. A: amber G: green JW: pure white R: red S: blue W: white Y: yellow
			DPDT	AL6M-M21②	AL6M-M21P②	
		12V AC/DC ±10%	SPDT	AL6M-M13②	AL6M-M13P②	
			DPDT	AL6M-M23②	AL6M-M23P②	
		24V AC/DC ±10%	SPDT	AL6M-M14②	AL6M-M14P②	
			DPDT	AL6M-M24②	AL6M-M24P②	
	Maintained	5V DC ±5%	SPDT	AL6M-A11②	AL6M-A11P②	
			DPDT	AL6M-A21②	AL6M-A21P②	
		12V AC/DC ±10%	SPDT	AL6M-A13②	AL6M-A13P②	
			DPDT	AL6M-A23②	AL6M-A23P②	
		24V AC/DC ±10%	SPDT	AL6M-A14②	AL6M-A14P②	
			DPDT	AL6M-A24②	AL6M-A24P②	
Square AL6Q   Marking plate size: □13.7 mm Engraving area: □12 mm (Depth: 0.5 mm max.)	Momentary	5V DC ±5%	SPDT	AL6Q-M11②	AL6Q-M11P②	
			DPDT	AL6Q-M21②	AL6Q-M21P②	
		12V AC/DC ±10%	SPDT	AL6Q-M13②	AL6Q-M13P②	
			DPDT	AL6Q-M23②	AL6Q-M23P②	
		24V AC/DC ±10%	SPDT	AL6Q-M14②	AL6Q-M14P②	
			DPDT	AL6Q-M24②	AL6Q-M24P②	
	Maintained	5V DC ±5%	SPDT	AL6Q-A11②	AL6Q-A11P②	
			DPDT	AL6Q-A21②	AL6Q-A21P②	
		12V AC/DC ±10%	SPDT	AL6Q-A13②	AL6Q-A13P②	
			DPDT	AL6Q-A23②	AL6Q-A23P②	
		24V AC/DC ±10%	SPDT	AL6Q-A14②	AL6Q-A14P②	
			DPDT	AL6Q-A24②	AL6Q-A24P②	
Rectangular AL6H   Marking plate size: 13.7 × 19.7 mm Engraving area: 12 × 18 mm (Depth: 0.5 mm max.)	Momentary	5V DC ±5%	SPDT	AL6H-M11②	AL6H-M11P②	
			DPDT	AL6H-M21②	AL6H-M21P②	
		12V AC/DC ±10%	SPDT	AL6H-M13②	AL6H-M13P②	
			DPDT	AL6H-M23②	AL6H-M23P②	
		24V AC/DC ±10%	SPDT	AL6H-M14②	AL6H-M14P②	
			DPDT	AL6H-M24②	AL6H-M24P②	
	Maintained	5V DC ±5%	SPDT	AL6H-A11②	AL6H-A11P②	
			DPDT	AL6H-A21②	AL6H-A21P②	
		12V AC/DC ±10%	SPDT	AL6H-A13②	AL6H-A13P②	
			DPDT	AL6H-A23②	AL6H-A23P②	
		24V AC/DC ±10%	SPDT	AL6H-A14②	AL6H-A14P②	
			DPDT	AL6H-A24②	AL6H-A24P②	
Rectangular w/three-sided barrier AL6G   Marking plate size: 13.7 × 19.7 mm Engraving area: 12 × 18 mm (Depth: 0.5 mm max.)	Momentary	5V DC ±5%	SPDT	AL6G-M11②	AL6G-M11P②	
			DPDT	AL6G-M21②	AL6G-M21P②	
		12V AC/DC ±10%	SPDT	AL6G-M13②	AL6G-M13P②	
			DPDT	AL6G-M23②	AL6G-M23P②	
		24V AC/DC ±10%	SPDT	AL6G-M14②	AL6G-M14P②	
			DPDT	AL6G-M24②	AL6G-M24P②	
	Maintained	5V DC ±5%	SPDT	AL6G-A11②	AL6G-A11P②	
			DPDT	AL6G-A21②	AL6G-A21P②	
		12V AC/DC ±10%	SPDT	AL6G-A13②	AL6G-A13P②	
			DPDT	AL6G-A23②	AL6G-A23P②	
		24V AC/DC ±10%	SPDT	AL6G-A14②	AL6G-A14P②	
			DPDT	AL6G-A24②	AL6G-A24P②	

• See page 7 for dimensions.

ø16 A6 Series Miniature Control Units

AL6 LED Illuminated Pilot Lights

Shape	Operating Voltage	Type No.		② Lens Color Code
		IP40	IP65	
Round AL6M-P   Marking plate size: ø13.7 mm Engraving area: ø12 mm (Depth: 0.5 mm max.)	5V DC ±5%	AL6M-P1②	AL6M-P1P②	Specify a color code in place of ② in the Type No. A: amber G: green JW: pure white R: red S: blue W: white Y: yellow
	12V AC/DC ±10%	AL6M-P3②	AL6M-P3P②	
	24V AC/DC ±10%	AL6M-P4②	AL6M-P4P②	
Square AL6Q-P   Marking plate size: □13.7 mm Engraving area: □12 mm (Depth: 0.5 mm max.)	5V DC ±5%	AL6Q-P1②	AL6Q-P1P②	
	12V AC/DC ±10%	AL6Q-P3②	AL6Q-P3P②	
	24V AC/DC ±10%	AL6Q-P4②	AL6Q-P4P②	
Rectangular AL6H-P   Marking plate size: 13.7 × 19.7 mm Engraving area: 12 × 18 mm (Depth: 0.5 mm max.)	5V DC ±5%	AL6H-P1②	AL6H-P1P②	
	12V AC/DC ±10%	AL6H-P3②	AL6H-P3P②	
	24V AC/DC ±10%	AL6H-P4②	AL6H-P4P②	
Rectangular w/three-sided barrier AL6-GP   Marking plate size: 13.7 × 19.7 mm Engraving area: 12 × 18 mm (Depth: 0.5 mm max.)	5V DC ±5%	AL6G-P1②	AL6G-P1P②	
	12V AC/DC ±10%	AL6G-P3②	AL6G-P3P②	
	24V AC/DC ±10%	AL6G-P4②	AL6G-P4P②	

• See page 7 for dimensions.

Dimensions (Illuminated Pushbuttons & Pilot Lights)

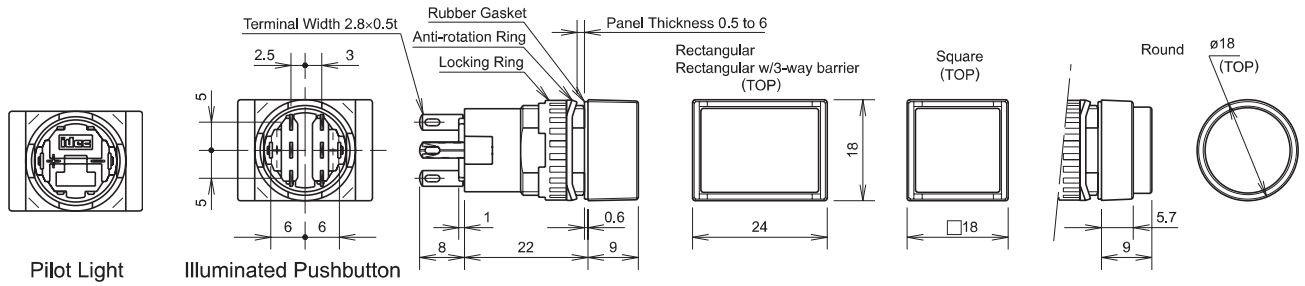

Terminal Arrangement (bottom view)

Illuminated Pushbutton

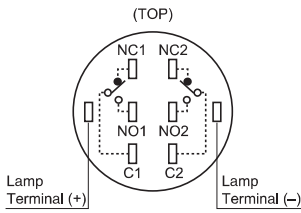

Pilot Light

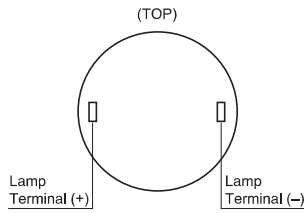

Mounting Hole Layout

Round/Square

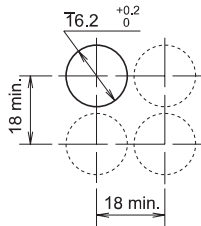

Rectangular w/3-way barrier

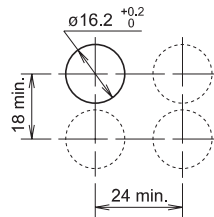









Note: Determine mounting centers to ensure easy operation.

All dimensions in mm.

ø16 A6 Series Miniature Control Units

AB6 Pushbuttons

Shape	Button Type	Operation Type	Contact	Type No.		Color Code ①②
				IP40	IP65	
Round AB6M  	Button	Momentary	SPDT	AB6M-M1①	AB6M-M1P①	B black G: green R: red S: blue W: white Y: yellow
			DPDT	AB6M-M2①	AB6M-M2P①	
		Maintained	SPDT	AB6M-A1①	AB6M-A1P①	
			DPDT	AB6M-A2①	AB6M-A2P①	
	Illumination Lens	Momentary	SPDT	AB6M-M1L②	AB6M-M1PL②	A: amber G: green R: red S: blue W: white Y: yellow
			DPDT	AB6M-M2L②	AB6M-M2PL②	
		Maintained	SPDT	AB6M-A1L②	AB6M-A1PL②	
			DPDT	AB6M-A2L②	AB6M-A2PL②	
Square AB6Q  	Button	Momentary	SPDT	AB6Q-M1①	AB6Q-M1P①	B black G: green R: red S: blue W: white Y: yellow
			DPDT	AB6Q-M2①	AB6Q-M2P①	
		Maintained	SPDT	AB6Q-A1①	AB6Q-A1P①	
			DPDT	AB6Q-A2①	AB6Q-A2P①	
	Illumination Lens	Momentary	SPDT	AB6Q-M1L②	AB6Q-M1PL②	A: amber G: green R: red S: blue W: white Y: yellow
			DPDT	AB6Q-M2L②	AB6Q-M2PL②	
		Maintained	SPDT	AB6Q-A1L②	AB6Q-A1PL②	
			DPDT	AB6Q-A2L②	AB6Q-A2PL②	
Rectangular AB6H  	Button	Momentary	SPDT	AB6H-M1①	AB6H-M1P①	B black G: green R: red S: blue W: white Y: yellow
			DPDT	AB6H-M2①	AB6H-M2P①	
		Maintained	SPDT	AB6H-A1①	AB6H-A1P①	
			DPDT	AB6H-A2①	AB6H-A2P①	
	Illumination Lens	Momentary	SPDT	AB6H-M1L②	AB6H-M1PL②	A: amber G: green R: red S: blue W: white Y: yellow
			DPDT	AB6H-M2L②	AB6H-M2PL②	
		Maintained	SPDT	AB6H-A1L②	AB6H-A1PL②	
			DPDT	AB6H-A2L②	AB6H-A2PL②	
Rectangular w/three-sided barrier AB6G  	Button	Momentary	SPDT	AB6G-M1①	AB6G-M1P①	B black G: green R: red S: blue W: white Y: yellow
			DPDT	AB6G-M2①	AB6G-M2P①	
		Maintained	SPDT	AB6G-A1①	AB6G-A1P①	
			DPDT	AB6G-A2①	AB6G-A2P①	
	Illumination Lens	Momentary	SPDT	AB6G-M1L②	AB6G-M1PL②	A: amber G: green R: red S: blue W: white Y: yellow
			DPDT	AB6G-M2L②	AB6G-M2PL②	
		Maintained	SPDT	AB6G-A1L②	AB6G-A1PL②	
			DPDT	AB6G-A2L②	AB6G-A2PL②	

• Specify a color code in place of ① or ② in the Type No.

Dimensions

(Pushbutton)

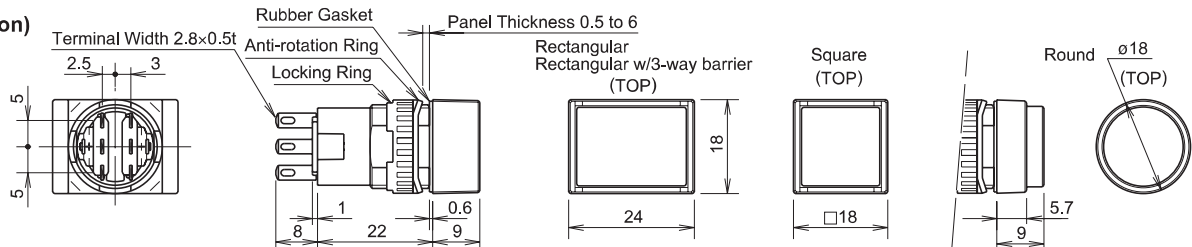

Mounting Hole Layout

• Round/Square

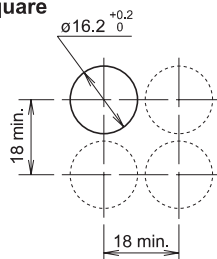

• Rectangular
• Rectangular
w/3-way barrier

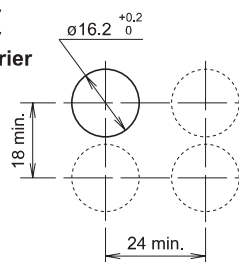

Note: Determine mounting centers to ensure easy operation.

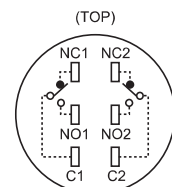

Terminal Arrangement (bottom view)

• Pushbutton



All dimensions in mm.

AB6M-V Pushbuttons (Pushlock Turn Reset)

Shape	Operation Type	Contact	Type No.		Button Color Code
			IP40	IP65	
 	Pushlock Turn Reset	SPDT	AB6M-V1R	AB6M-V1PR	R: red only
		DPDT	AB6M-V2R	AB6M-V2PR	

• Do not use the AB6M-V pushbuttons as emergency stop switches.
 For the application of emergency stop switch, use the XA or H6 series switches (ISO 13850, IEC 60947-5-5 compliant).

Dimensions

(Pushlock Turn Reset Pushbutton)

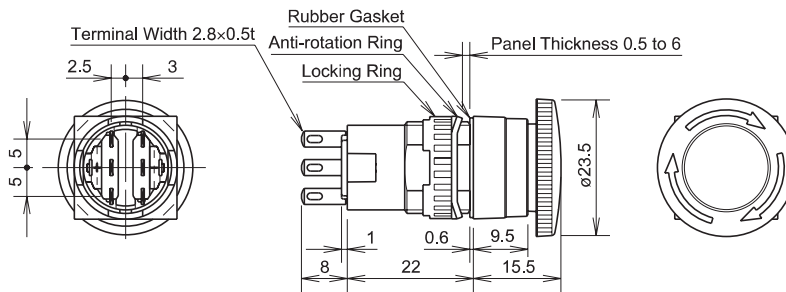

Terminal Arrangement (bottom view)

(Pushbutton)

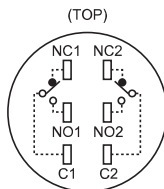

SPDT has NC1, NO1, and C1 only.

Mounting Hole Layout

• w/Mushroom Button
 (Pushlock Turn Reset)



Note: Determine mounting centers to ensure easy operation.

All dimensions in mm.

ø16 A6 Series Miniature Control Units

AS6 Selector Switches

Operator position can be changed by IDEC's original bezel rotating and locking system. The bezel can be locked at every 45° and bezel rotation is prevented while mounting on a panel.

• How to change the operator position

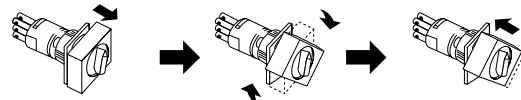

Pull out the bezel to release the lock. Rotate the bezel, and push it in at 45° intervals to lock the bezel.

3-position Types

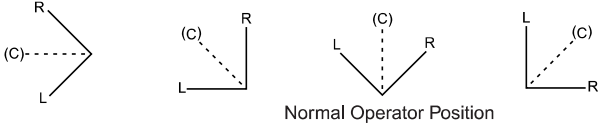

Shape	Position	Contact	Type No.	
			IP40	IP65
Round AS6M-□Y 	90° 2-position	Maintained	SPDT AS6M-2Y1	AS6M-2Y1P
			DPDT AS6M-2Y2	AS6M-2Y2P
		Spring return from right to left	SPDT AS6M-21Y1	AS6M-21Y1P
	45° 3-position	Maintained	DPDT AS6M-3Y2	AS6M-3Y2P
		Spring return from right to center	DPDT AS6M-31Y2	AS6M-31Y2P
		Spring return from left to center	DPDT AS6M-32Y2	AS6M-32Y2P
Square AS6Q-□Y 	90° 2-position	Maintained	SPDT AS6Q-2Y1	AS6Q-2Y1P
			DPDT AS6Q-2Y2	AS6Q-2Y2P
		Spring return from right to left	SPDT AS6Q-21Y1	AS6Q-21Y1P
	45° 3-position	Maintained	DPDT AS6Q-3Y2	AS6Q-3Y2P
		Spring return from right to center	DPDT AS6Q-31Y2	AS6Q-31Y2P
		Spring return from left to center	DPDT AS6Q-32Y2	AS6Q-32Y2P
Rectangular AS6H-□Y 	90° 2-position	Maintained	SPDT AS6H-2Y1	AS6H-2Y1P
			DPDT AS6H-2Y2	AS6H-2Y2P
		Spring return from right to left	SPDT AS6H-21Y1	AS6H-21Y1P
	45° 3-position	Maintained	DPDT AS6H-3Y2	AS6H-3Y2P
		Spring return from right to center	DPDT AS6H-31Y2	AS6H-31Y2P
		Spring return from left to center	DPDT AS6H-32Y2	AS6H-32Y2P
	Spring return two-way	DPDT AS6H-33Y2	AS6H-33Y2P	

Contact Operation				
Position	Operation Type	Left	Center	Right
90° 2-position	Maintained	SPDT		
			—	
	Spring return from right	DPDT		
			—	
45° 3-position	Maintained	DPDT		
	Spring return from right			
	Spring return from left			
	Two-way return			

• Bezel: black

• Knob: black

Dimensions

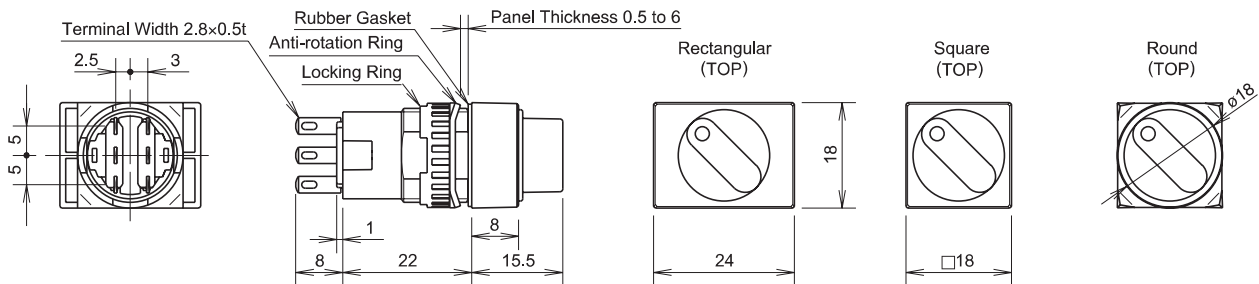

Terminal Arrangement (bottom view)

(Selector Switch)

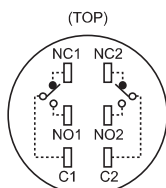

Mounting Hole Layout

• Round/Square

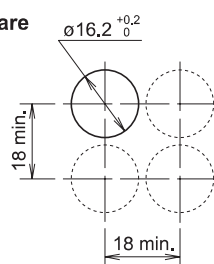



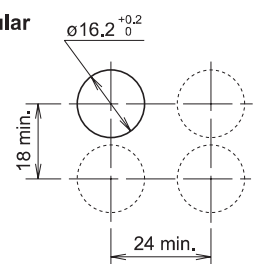



















• Rectangular



Note: Determine mounting centers to ensure easy operation.













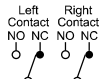

All dimensions in mm.

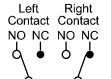
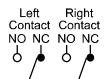
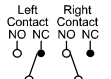
AS6M Key Selector Switches

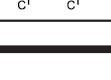
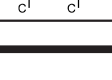
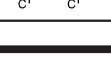

















Shape	Position	Operation Type	Key Retained at ●	Contact	Type No.			
					IP40	IP65		
 	90° 2-position	Maintained	A		SPDT	AS6M-2KT1A	AS6M-2KT1PA	
					DPDT	AS6M-2KT2A	AS6M-2KT2PA	
			B		SPDT	AS6M-2KT1B	AS6M-2KT1PB	
					DPDT	AS6M-2KT2B	AS6M-2KT2PB	
			C		SPDT	AS6M-2KT1C	AS6M-2KT1PC	
					DPDT	AS6M-2KT2C	AS6M-2KT2PC	
		Spring return from right		B		SPDT	AS6M-21KT1B	AS6M-21KT1PB
					DPDT	AS6M-21KT2B	AS6M-21KT2PB	
	A				DPDT	AS6M-3KT2A	AS6M-3KT2PA	
	B				DPDT	AS6M-3KT2B	AS6M-3KT2PB	
	C				DPDT	AS6M-3KT2C	AS6M-3KT2PC	
	D				DPDT	AS6M-3KT2D	AS6M-3KT2PD	
		Maintained		E		DPDT	AS6M-3KT2E	AS6M-3KT2PE
	G				DPDT	AS6M-3KT2G	AS6M-3KT2PG	
	H				DPDT	AS6M-3KT2H	AS6M-3KT2PH	
	B				DPDT	AS6M-31KT2B	AS6M-31KT2PB	
	D				DPDT	AS6M-31KT2D	AS6M-31KT2PD	
	G				DPDT	AS6M-31KT2G	AS6M-31KT2PG	
		Spring return from right		C		DPDT	AS6M-32KT2C	AS6M-32KT2PC
	D				DPDT	AS6M-32KT2D	AS6M-32KT2PD	
H				DPDT	AS6M-32KT2H	AS6M-32KT2PH		
	Spring return from left		C		DPDT	AS6M-32KT2C	AS6M-32KT2PC	
D				DPDT	AS6M-32KT2D	AS6M-32KT2PD		
	Spring return two-way		H		DPDT	AS6M-32KT2H	AS6M-32KT2PH	
D				DPDT	AS6M-33KT2D	AS6M-33KT2PD		

- Key is retained at ● positions and removable at ○ positions.
- Two keys are supplied.
- The front of key cylinder is made of metal.
- See page 14 for dimensions.

Contact Operation











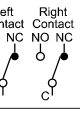
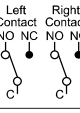

Operator Position & Contact Operation (Top View)					
Positions		Contact	↙ Left	↑ Center	↘ Right
90° 2-position		SPDT		—	
			DPDT		—
45° 3-position		DPDT			
					
					
					

AS6Q Key Selector Switches



















Shape	Position	Operation Type	Key Retained at ●	Contact	Type No.								
					IP40	IP65							
Square AS6Q  	90° 2-position	Maintained	A		SPDT	AS6Q-2KT1A	AS6Q-2KT1PA						
					DPDT	AS6Q-2KT2A	AS6Q-2KT2PA						
			B		SPDT	AS6Q-2KT1B	AS6Q-2KT1PB						
					DPDT	AS6Q-2KT2B	AS6Q-2KT2PB						
			C		SPDT	AS6Q-2KT1C	AS6Q-2KT1PC						
					DPDT	AS6Q-2KT2C	AS6Q-2KT2PC						
		Spring return from right		B		SPDT	AS6Q-21KT1B	AS6Q-21KT1PB					
					DPDT	AS6Q-21KT2B	AS6Q-21KT2PB						
	45° 3-position			Maintained		A		DPDT	AS6Q-3KT2A	AS6Q-3KT2PA			
						B		DPDT	AS6Q-3KT2B	AS6Q-3KT2PB			
						C		DPDT	AS6Q-3KT2C	AS6Q-3KT2PC			
						D		DPDT	AS6Q-3KT2D	AS6Q-3KT2PD			
		E				DPDT	AS6Q-3KT2E	AS6Q-3KT2PE					
		G				DPDT	AS6Q-3KT2G	AS6Q-3KT2PG					
			Spring return from right		B		DPDT	AS6Q-31KT2B	AS6Q-31KT2PB				
						D		DPDT	AS6Q-31KT2D	AS6Q-31KT2PD			
						G		DPDT	AS6Q-31KT2G	AS6Q-31KT2PG			
		Spring return from left					C		DPDT	AS6Q-32KT2C	AS6Q-32KT2PC		
									D		DPDT	AS6Q-32KT2D	AS6Q-32KT2PD
									H		DPDT	AS6Q-32KT2H	AS6Q-32KT2PH
	Spring return two-way		D		DPDT	AS6Q-33KT2D	AS6Q-33KT2PD						

- Key is retained at ● positions and removable at ○ positions.
- Two keys are supplied.
- The front of key cylinder is made of metal.
- See page 14 for dimensions.

Contact Operation









Operator Position & Contact Operation (Top View)					
Positions		Contact	← Left	↑ Center	→ Right
90° 2-position	Maintained 	SPDT		—	
	Spring return from right 	DPDT		—	
45° 3-position	Maintained 	DPDT			
	Spring return from right 				
	Spring return from left 				
	Spring return two-way 				

AS6H Key Selector Switches

Shape	Position	Operation Type	Key Retained at ●	Contact	Type No.							
					IP40	IP65						
 	90° 2-position	Maintained	A		SPDT	AS6H-2KT1A	AS6H-2KT1PA					
					DPDT	AS6H-2KT2A	AS6H-2KT2PA					
			B		SPDT	AS6H-2KT1B	AS6H-2KT1PB					
					DPDT	AS6H-2KT2B	AS6H-2KT2PB					
			C		SPDT	AS6H-2KT1C	AS6H-2KT1PC					
					DPDT	AS6H-2KT2C	AS6H-2KT2PC					
		Spring return from right		B		SPDT	AS6H-21KT1B	AS6H-21KT1PB				
					DPDT	AS6H-21KT2B	AS6H-21KT2PB					
	45° 3-position			Maintained		A		DPDT	AS6H-3KT2A	AS6H-3KT2PA		
						B		DPDT	AS6H-3KT2B	AS6H-3KT2PB		
						C		DPDT	AS6H-3KT2C	AS6H-3KT2PC		
						D		DPDT	AS6H-3KT2D	AS6H-3KT2PD		
		E				DPDT	AS6H-3KT2E	AS6H-3KT2PE				
		G				DPDT	AS6H-3KT2G	AS6H-3KT2PG				
			Spring return from right		B		DPDT	AS6H-31KT2B	AS6H-31KT2PB			
						D		DPDT	AS6H-31KT2D	AS6H-31KT2PD		
						G		DPDT	AS6H-31KT2G	AS6H-31KT2PG		
		Spring return from left					C		DPDT	AS6H-32KT2C	AS6H-32KT2PC	
								D		DPDT	AS6H-32KT2D	AS6H-32KT2PD
								H		DPDT	AS6H-32KT2H	AS6H-32KT2PH
		Spring return two-way		D		DPDT	AS6H-33KT2D	AS6H-33KT2PD				

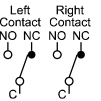
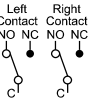
- Key is retained at ● positions and removable at ○ positions.
- Two keys are supplied.
- The front of key cylinder is made of metal.
- See page 14 for dimensions.

Contact Operation

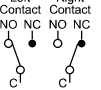
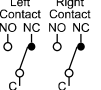
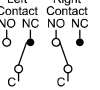
Operator Position & Contact Operation (Top View)				
Positions	Contact	Left	Center	Right
90° 2-position  Maintained  Spring return from right	SPDT		—	
	DPDT		—	
45° 3-position  Maintained  Spring return from right  Spring return from left  Spring return two-way	DPDT			

ø16 A6 Series Miniature Control Units

Dimensions

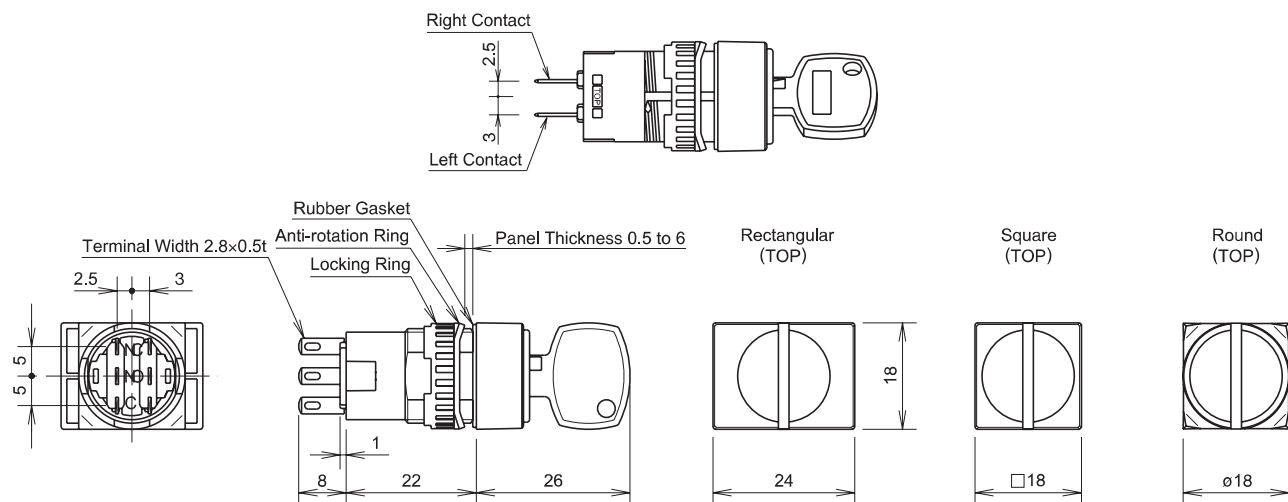

Terminal Arrangement (bottom view)

(Key Selector Switch)

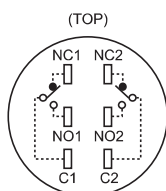

SPDT has NC1, NO1, and C1 only.

Mounting Hole Layout

• Round/Square

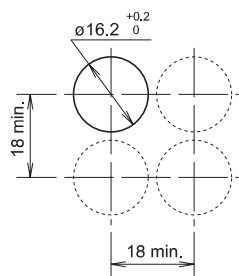



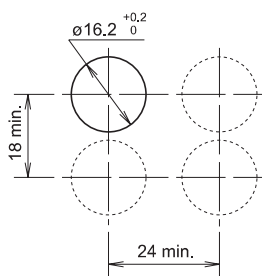





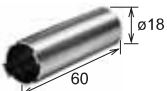

• Rectangular

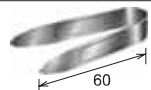

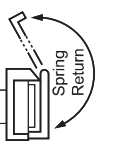
Note: Determine mounting centers to ensure easy operation.



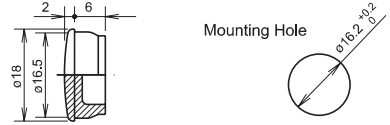

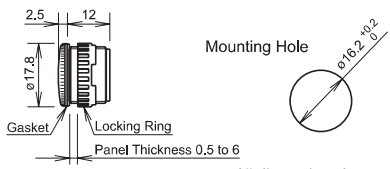

All dimensions in mm.

Accessories



Shape		Material	Type No.	Ordering Type No.	Package Quantity	Dimensions (mm)	
		Metal (nickel-plated brass)	MT-001	MT-001	1	<ul style="list-style-type: none"> Used to tighten the locking ring when installing A6 control units into a panel. Tighten the locking ring to a torque of 0.88 N·m maximum. 	
		Rubber	OR-77	OR-77	1	<ul style="list-style-type: none"> Used to install and remove the LED lamps. 	
		Stainless Steel	MT-101	MT-101	1	<ul style="list-style-type: none"> Used to install and remove lenses and buttons. 	
	For round/square units (remains 90° open)	Guard (polyarylate) Base (polyacetal)	AL-K6	AL-K6	1	<ul style="list-style-type: none"> Degree of protection: IP40 Used to protect pushbuttons from inadvertent operation. 	
	For rectangular units (remains 110° open)		AL-KH6	AL-KH6	1		
	For round/square units (180° spring return)		AL-K6S	AL-K6S	1		
			For rectangular units (180° spring return)	AL-K6SP	AL-K6SP	1	<ul style="list-style-type: none"> Degree of protection: IP65 (when used with IP65 control units) Used to protect pushbuttons from inadvertent operation.
				AL-KH6S	AL-KH6S	1	<ul style="list-style-type: none"> Degree of protection: IP40 Used to protect pushbuttons from inadvertent operation.
				AL-KH6SP	AL-KH6SP	1	<ul style="list-style-type: none"> Degree of protection: IP65 (when used with IP65 control units) Used to protect pushbuttons from inadvertent operation.
	For round units	Translucent cover: elastomer Black part: polypropylene	AL-D6	AL-D6	1	<ul style="list-style-type: none"> When mounting the control units with the dust covers installed, refer to mounting hole layout on page 18. Operating temperature: -10 to +55°C 	
	For square units		AL-DQ6	AL-DQ6	1		
	For rectangular units		AL-DH6	AL-DH6	1		
		Translucent nylon (white)	AL-V6	AL-V6PN10	10	<ul style="list-style-type: none"> When wiring the terminals, insert the lead wires into the terminal cover holes before soldering. Terminal cover is not attached and must be ordered separately. 	
	Solder Terminal	See page 18 for dimensions.	AL-C6	AL-C6	1	<ul style="list-style-type: none"> Plugs on the rear of the A series control units. 	
	PC Board Terminal		AL-C6V	AL-C6V	1		
		Rubber	Nitril rubber (black)	AL-B6	AL-B6PN05	5	<ul style="list-style-type: none"> Degree of protection: IP65 
		Metal	Metal (diecast) • Locking ring: plastic	AL-BM6	AL-BM6	1	<ul style="list-style-type: none"> Degree of protection: IP65  <p>All dimensions in mm.</p>

ø16 A6 Series Miniature Control Units

Maintenance Parts

Shape		Specification	Type No.	Ordering Type No.	Package Quantity	Color Code ①②														
	Round	Polyarylate	AL6M-L②	AL6M-L②PN05	5	Specify a color code in place of ② in the Type No. A (amber), C (clear), G (green) R (red), S (blue), Y (yellow) • Use a C (clear) lens for W (white) and JW (pure white) illumination.														
	Square		AL6Q-L②	AL6Q-L②PN05																
	Rectangular		AL6H-L②	AL6H-L②PN05																
	Round	Polyarylate	AB6M-B①	AB6M-B①PN05		5	Specify a color code in place of ① in the Type No. B (black), G (green), R (red) S (blue), W (white), Y (yellow)													
	Square		AB6Q-B①	AB6Q-B①PN05																
	Rectangular		AB6H-B①	AB6H-B①PN05																
	Round	Acrylic	AL6M-W	AL6M-WPN05		5	• White													
	Square		AL6Q-W	AL6Q-WPN05																
	Rectangular		AL6H-W	AL6H-WPN05																
	Round (installed on round units)	Translucent color lens	AL6M-LK2-M②	AL6M-LK2-M②	1	<ul style="list-style-type: none"> Specify a color code in place of ② in the Type No. Degree of protection: IP65 ② Color Code <table border="1" data-bbox="1161 853 1422 1037"> <thead> <tr> <th>Translucent Color Lens</th> <th>Opaque Button</th> </tr> </thead> <tbody> <tr> <td>A (amber)</td> <td>B (black)</td> </tr> <tr> <td>G (green)</td> <td>G (green)</td> </tr> <tr> <td>R (red)</td> <td>R (red)</td> </tr> <tr> <td>S (blue)</td> <td>S (blue)</td> </tr> <tr> <td>W (white)</td> <td>W (white)</td> </tr> <tr> <td>Y (yellow)</td> <td>Y (yellow)</td> </tr> </tbody> </table>	Translucent Color Lens	Opaque Button	A (amber)	B (black)	G (green)	G (green)	R (red)	R (red)	S (blue)	S (blue)	W (white)	W (white)	Y (yellow)	Y (yellow)
		Translucent Color Lens	Opaque Button																	
	A (amber)	B (black)																		
	G (green)	G (green)																		
	R (red)	R (red)																		
	S (blue)	S (blue)																		
W (white)	W (white)																			
Y (yellow)	Y (yellow)																			
Square (installed on square units)	Translucent color lens	AL6Q-LK2-Q②	AL6Q-LK2-Q②																	
	Opaque button	AB6Q-BK2-Q②	AB6Q-BK2-Q②																	
Rectangular (installed on square units)	Translucent color lens	AL6Q-LK2-H②	AL6Q-LK2-H②																	
	Opaque button	AB6Q-BK2-H②	AB6Q-BK2-H②																	
		Plastic	HA9Z-LN	HA9Z-LNPN10	10	• Black														
				Metal			AL6-LP	AL6-LPPN10												
	For key selector switches	Brass with nickel plating			AS6-SK-132	AS6-SK-132PN02	2	• Thickness 2.0 mm												

LED Lamps

Operating Voltage	Current Draw		Type No.	Ordering Type No.	② Illumination Color Code	Package Quantity	Base
	AC	DC					
 5V DC ±5%	—	8 mA	LATD-5②	LATD-5②	Specify a color code in place of ② in the Ordering Type No.	1	Exclusive for A6 series
				LATD-5②PN10		10	
 12V AC/DC ±10%	9 mA	8 mA	LATD-1②	LATD-1②	A: amber G: green JW: pure white R: red S: blue W: white Y: yellow	1	
				LATD-1②PN10		10	
 24V AC/DC ±10%	9 mA	8 mA	LATD-2②	LATD-2②		1	
				LATD-2②PN10		10	

Transformer

Shape	Primary Voltage	Secondary Voltage	Type No.	Applicable LED Lamp
	100/110V AC	24V AC, 0.5W	TWR512	LATD-2②
	200/220V AC		TWR522	
	400/440V AC		TWR542	

- Terminal covers are supplied with separate mounting type transformers.
- Connect only one LATD LED to separate mounting type transformers.
- Use mounting bracket BC9Z-E/NS35N when using on 400/440V primary voltage.

Specifications

Operating Voltage	100/110V AC, 200/220V AC, 400/440V AC (50/60 Hz)	
Power Consumption	2.4VA	
Rated Insulation Voltage	600V	
Insulation Resistance	100 MΩ minimum (500V DC megger)	
Standard Operating Condition	Operating Temperature	-30 to +60°C (no freezing)
	Relative Humidity	35 to 85% (no condensation)
Vibration Resistance	Operation Extremes	5 to 55 Hz, amplitude 0.5 mm
	Damage Limits	1,000 m/s ²
Shock Resistance	2500V AC, 1 minute	
Dielectric Strength	M3.5	
Terminal Screw	2 mm ² maximum, 2 wires maximum	
Applicable Wire		

Dimensions

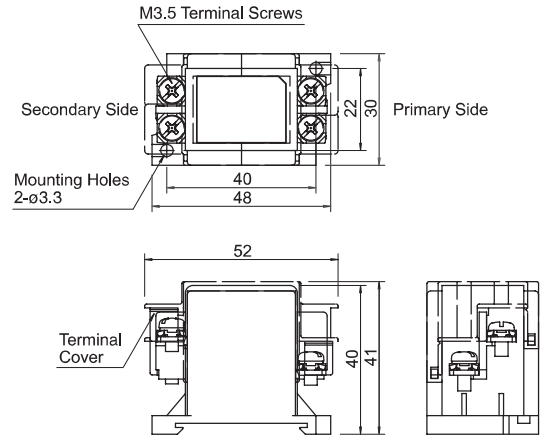

Accessories

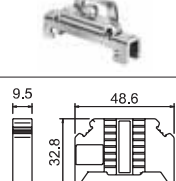
Description	Appearance	Description	Type No.	Ordering Type No.	Package Quantity
DIN Rail		Aluminum Weight: Approx. 200g	BAA1000	BAA1000PN10	10
		Steel Weight: Approx. 320g	BAP1000	BAP1000PN10	
Mounting Clip		Steel Weight: Approx. 15g	BNL6	BNL6PN10	
		Plastic Weight: Approx. 15g	BC9Z-E/NS35N	BC9Z-E/NS35NPN10	

- Use mounting clip BC9Z-E/NS35N when using on 400/440V primary voltage.

Maintenance Parts

Dimensions

- Switch Guard (Degree of protection: IP40)

For Round/Square Units
(AL-K6) (AL-K6S)

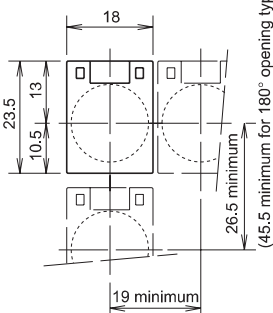

For rectangular units
(AL-KH6) (AL-KH6S)

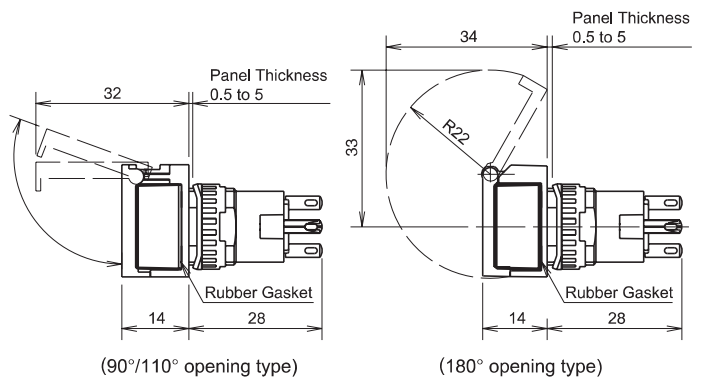
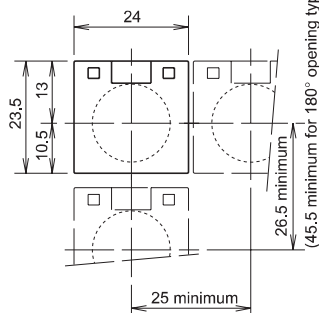

All dimensions in mm.

ø16 A6 Series Miniature Control Units

• Switch Guard (Degree of protection: IP65)

For Round/Square Units
(AL-K6SP)

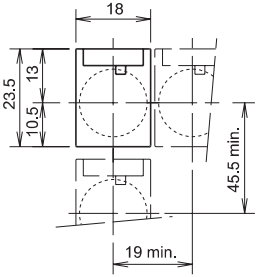

For Rectangular Units
(AL-KH6SP)

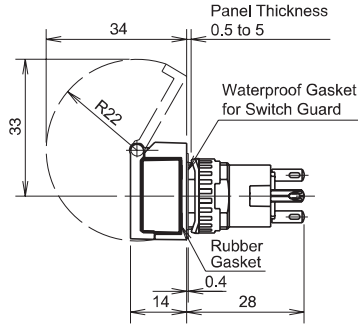
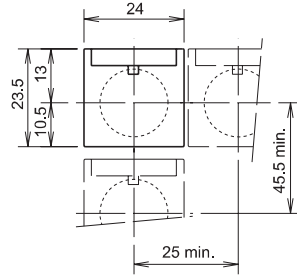

• Socket

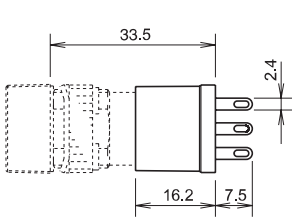

Solder Terminal Type
(AL-C6)

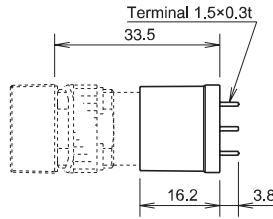
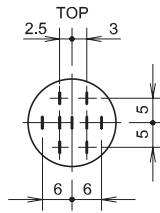

PC Board Terminal Type
(AL-C6V)

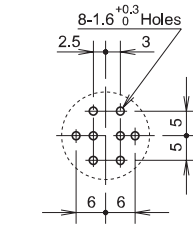

PC Board
Mounting Hole Layout
(Bottom View)

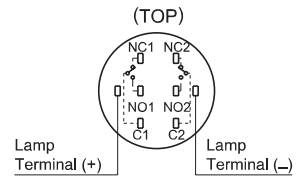

Terminal Arrangement
(Bottom View)

• Terminal Cover

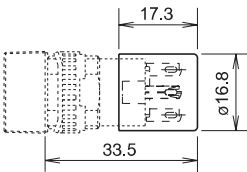

Note: When wiring the terminals, insert the lead wires into the terminal cover holes before soldering.

• Dust Cover

For Round Units
(AL-D6)

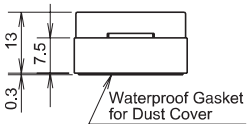
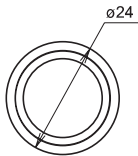

For Square Units
(AL-DQ6)

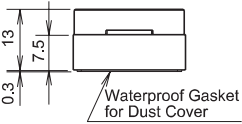
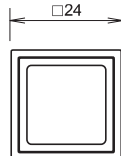

For Rectangular Units
(AL-DH6)

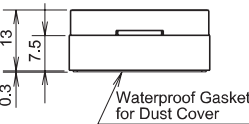
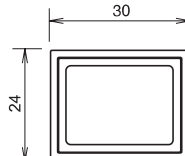

• Mounting Hole Centers

Round/Square Units

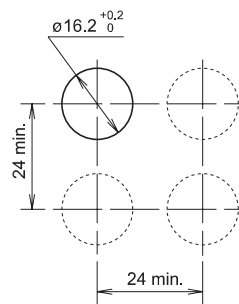

Rectangular Units

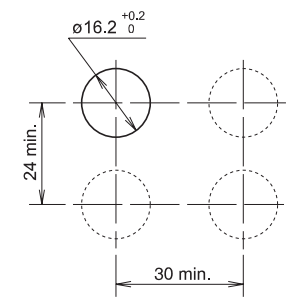

• Large Lens and Large Button

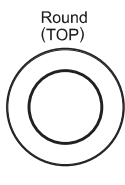
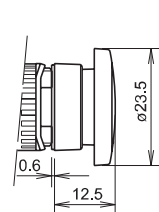
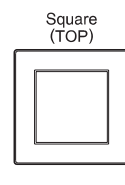
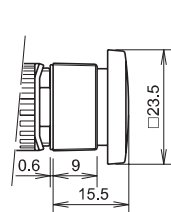
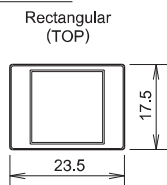
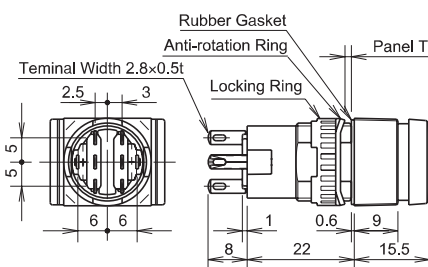

All dimensions in mm.

Safety Precautions

- Turn off the power to A series control units before starting installation, removal, wiring, maintenance, and inspection of the control units. Failure to turn power off may cause electrical shocks or fire hazard.
- To avoid a burn on your hand, use the lamp holder tool when replacing lamps.
- For wiring, use wires of a proper size to meet the voltage and current requirements. Failure to tighten terminal screws may cause overheating and create a fire hazard.

Operating Instructions

Replacement of Lens and Marking Plate

• Removal

Remove the lens assembly (color lens, marking plate, lens holder, and spring) by holding the color lens recesses with the Lens Removal Tool (MT-101) and pulling it out. Remove the marking plate by disengaging the latches between the color lens and lens holder. The marking plate must be engraved on the front side as shown at right.

When using a color film, insert it between the color lens and marking plate.

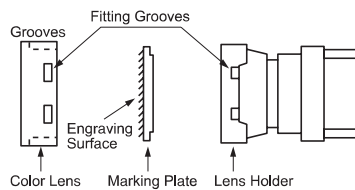

• Installation

Place the marking plate on the lens holder in the correct direction, and press the color lens onto the lens holder to engage the latches. Put the spring on the lens holder and insert the lens holder into the housing in the correct direction.

Marking

For A series illuminated pushbuttons, legends and symbols can be engraved on the built-in marking plates, or printed film can be inserted under the lens for labelling purposes.

Marking Plate & Engraving Area

	Round	Square	Rectangular
Built-in Marking Plate and Engraving Area			
	<ul style="list-style-type: none"> • Engraving must be made on the engraving area within 0.5mm deep. • The marking plate is made of white acrylic resin. 		
Applicable Marking Film (not supplied)			
	<ul style="list-style-type: none"> • Thickness = 0.1 mm × 1 film • Recommended film material: polyester 		

Replacing the LED Lamp

• Removal

Use the lamp holder tool (OR-77) to remove lamps. Do not use pliers.

• Installation

Use the lamp holder tool (OR-77) to install lamps. Note the correct side of the tool for removal or installation.

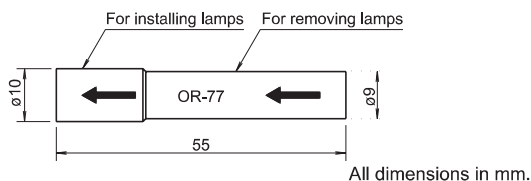

Panel Mounting

When mounting the control units into a panel, use the optional locking ring wrench (MT-001) to tighten the locking ring. Do not use pliers. Tightening torque must not exceed 0.88 N·m. Excessive tightening will damage the locking ring.

Wiring

Solder the terminal at 350°C within 3 seconds using a 60W soldering iron. Sn-Ag-Cu type is recommended when using lead-free solder. When soldering, do not touch the control unit with the soldering iron. Also ensure that no tensile force is applied to the terminal. Do not bend the terminal or apply excessive force to the terminal. Use a non-corrosive rosin flux.

Installing the Socket

Install the socket on the control unit with the TOP markings on the control unit and the socket placed in the same direction.

Switch Guard

Waterproof (IP65) / oiltight type switch guards must be used with waterproof (IP65) / oiltight type control units only. Even if IP65 type switch guards are installed, enclosed type (IP40) control units are not made waterproof.

Item		Switch Guard	
		IP65 (waterproof)	IP40 (enclosed type)
Control Unit	IP65 (waterproof)	IP65	IP40
	IP40 (enclosed type)	IP40	IP40

Operating Voltage of LED Lamps

The operating voltage of 5V DC is measured at complete DC.

Other Notes

• Close Proximity Mounting

When mounting pilot lights or illuminated pushbuttons collectively or lighting them continuously, heat may cause the ambient temperature to rise above the rated operating temperature. When the mounting panel is not made of metal or when the control units are mounted in an enclosed panel, provide for ventilation or lower the operating voltage.

• Replacement of Buttons (Illuminated/Non-illuminated)

Do not replace buttons of maintained action units while the button is in the locked position. Replacing the button in the locked position may damage the internal mechanism. Be sure to release the button before replacing.

• Operating and Storage Environment

1. Make sure that the operating/storage temperature and humidity are within the ratings.
2. Do not use enclosed type units in an environment subject to oil, water or dust accumulation. In such an area, use the waterproof/oiltight units (IP65).

• Microswitch Contacts

Do not connect NO and NC contacts of a microswitch to different voltages or different power sources to prevent a dead short-circuit.

• IP65 Type Units

IP65 type units are evaluated by conventional cutting and cooling oils, and can not be used with some special oils. Contact IDEC for resistance against specific oils.

ø16 Flush Silhouette L6/A6 Series Accessories

New flush silhouette bezels for L6/A6 series ø16mm miniature control units

- Accessories for L6/A6 control units.
- Bezel Size
 - Round: ø24 mm (Panel Cut-out: ø20.2 mm)
 - Square: □24 mm (Panel Cut-out: □20.2 mm)
 - Rectangular: 24×30 mm (Panel Cut-out: 20.2×26.2 mm)





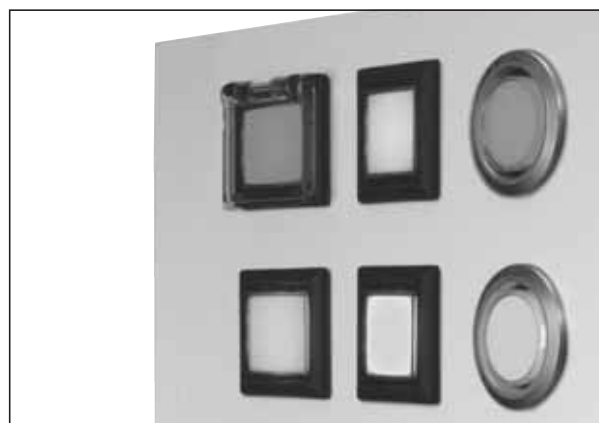



• Applicable models

L6 Series	A6 Series
Illuminated Pushbutton	Illuminated Pushbutton
Pilot Light	Pilot Light
Pushbutton	Pushbutton
Selector Switch	Selector Switch
Key Selector Switch	Key Selector Switch
Illuminated Selector Switch	Illuminated Selector Switch
Lever Switch	
Buzzer	





Note: Flush silhouette bezels cannot be used for mushroom buttons or lenses.

Flush Bezel

	Shape	Specification	Type	Package Quantity	Remarks
Flush Bezel	Round 	Metal (aluminum color)	LA9Z-SM61	1	• Degree of protection: IP65 (only when used with IP65 control units)
	Round 	Plastic (black)	LA9Z-S61B	1	
	Square 	Plastic (black)	LA9Z-S71B	1	
	Rectangular 	Plastic (black)	LA9Z-S81B	1	
Switch Guard with Flush Bezel (Spring Return) Rectangular 		Plastic	LA9Z-KS8	1	• Used for L6/A6 rectangular pushbuttons and illuminated pushbuttons. Cannot be used for selector switches, illuminated selector switches, and lever switches. • Degree of protection: IP65 (only when used with IP65 control units)
Rubber Boot		Round	LA9Z-DS6	1	• Rubber boot is supplied with a flush bezel. • Degree of protection: IP65 • Applicable type: L6/A6 series illuminated pushbuttons and pushbuttons
		Square	LA9Z-DS7	1	
		Rectangular	LA9Z-DS8	1	

Note: Terminal covers and maintenance parts for L6/A6 other than those shown above can also be used, except switch guard (AL-K) and rubber boot (AL-D).

Shape	Specification	Type	Package Quantity	Remarks
Round 	Plastic (black)	LA9Z-BS6	1	<ul style="list-style-type: none"> Degree of protection: IP65 Panel thickness: 0.5 to 5 mm
Square 	Plastic (black)	LA9Z-BS7	1	
Rectangular 	Plastic (black)	LA9Z-BS8	1	

Ordering Information

- Control units are not supplied with flush bezels. Order flush bezels together with control units.

Specifications

- Based on L6/A6 series control unit specifications.

Dimensions

Flush Bezel

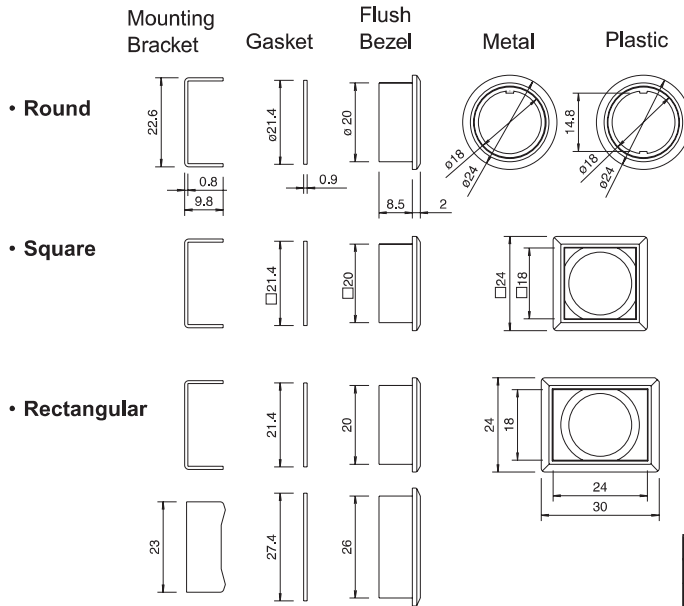

Flush Bezel with Control Units

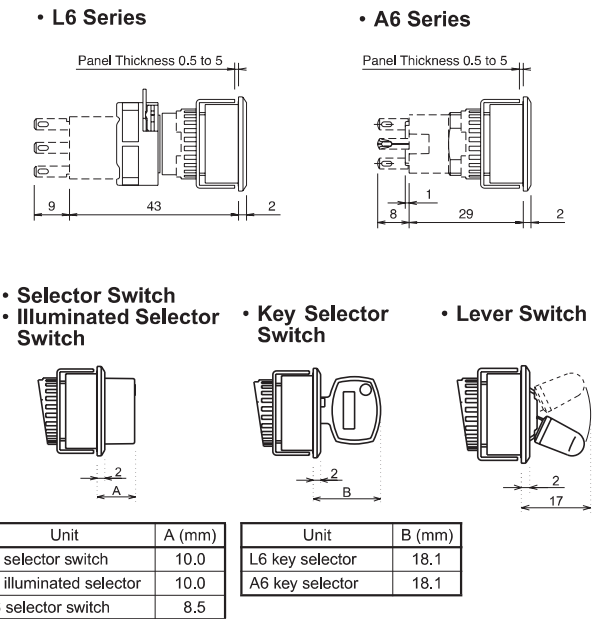

Mounting Hole Layout

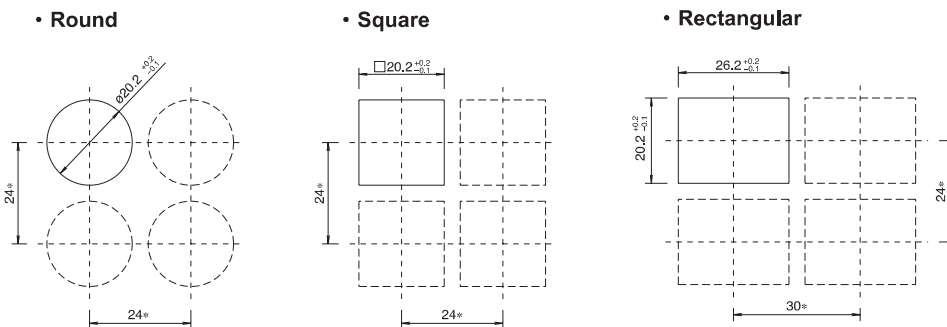

*When mounting the rubber boot:
 Round and square types: 27 mm minimum
 Rectangular type: Vertical 27 mm, Horizontal 33 mm minimum

Mounting hole layout for the L6 series is the same for both straight-lever contact type and L-lever contact type.

Flush Bezel with Switch Guard

• L6 Series

• A6 Series

[Mounting Hole Layout]

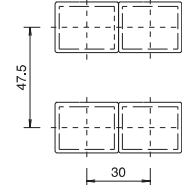
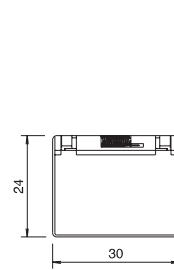
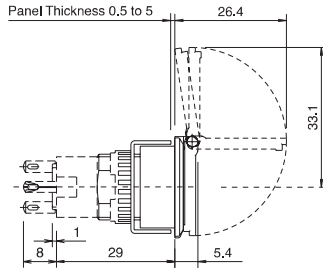
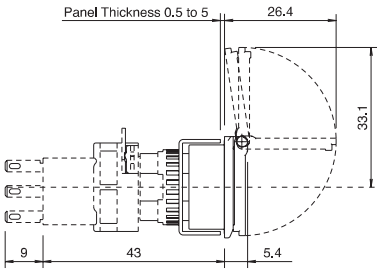

Mounting holes are the same size as rectangular flush bezels.

Mounting Hole Plug

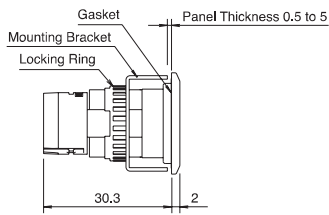

• Round

• Square

• Rectangular

Mounting holes are the same size as flush bezels.

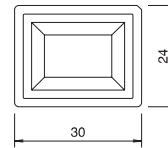
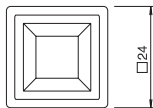
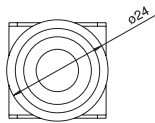

Rubber Boot

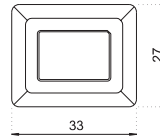
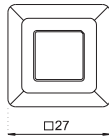
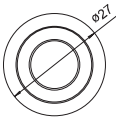
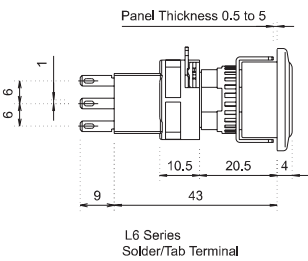

All dimensions in mm.

Safety Precautions

- Turn off the power to the control units before starting installation, removal, wiring, maintenance, and inspection of the products. Failure to turn power off may cause electrical shocks or fire hazard.
- To avoid burning your hand, use the lamp holder tool when replacing lamps.
- For wiring, use wires of a proper size to meet the voltage and current requirements and solder correctly. Improper soldering may cause overheating and fire hazard. Also, when using tab terminals, use appropriate quick connect receptacles.

Instructions

Panel Mounting of Flush Bezels

• L6 series

1. Remove the contact block from the operator. Remove the locking ring and anti-rotation ring. To remove the operator from the contact block, turn the locking lever in the direction opposite to the arrow on the housing.
2. Attach the flush bezel to the operator. Then insert the assembly into the panel. Attach the mounting bracket and tighten the locking ring. (Do not use the anti-rotation ring supplied with the operator.)
For round flush bezels, place the projection on the bezel to the groove on the TOP side of the operator and mount onto the panel.
3. Insert the contact block, with the TOP markings on the contact block and the operator placed in the same direction. Then lock the units, turning the locking lever in the direction of the arrow.

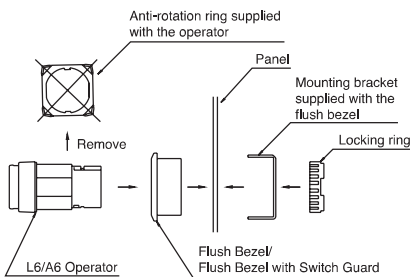

• A6 series

1. Remove the locking ring and anti-rotation ring from the operator.
2. Attach the flush bezel to the operator. Then insert the assembly into the panel. Attach the mounting bracket and tighten the locking ring. (Do not use the anti-rotation ring supplied with the operator.)
For round flush bezels, place the projection on the bezel to the groove on the TOP side of the operator and mount onto the panel.

Panel Mounting of Flush Bezels with Switch Guard

For installation, see Panel Mounting of Flush Bezels.

Installing the Rubber Boot

Attach the rubber boot and the flush bezel to the operator. Then insert the assembly into the panel. Attach the mounting bracket and tighten the locking ring. Tighten the locking ring to the recommended tightening torque of 0.88N·m. (Do not use the anti-rotation ring supplied with the operator.)

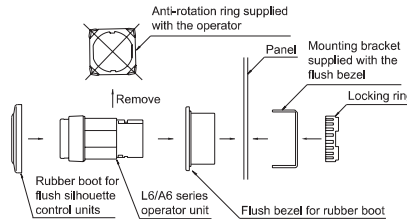

• Precautions for Installing the Rubber Boot

Install the rubber boot to wrap around the entire periphery of the flush bezel. Make sure that the projection on the rubber boot is placed into the groove on the back of the bezel. If the projection is not placed correctly, the normal waterproof/dustproof characteristics are not ensured.

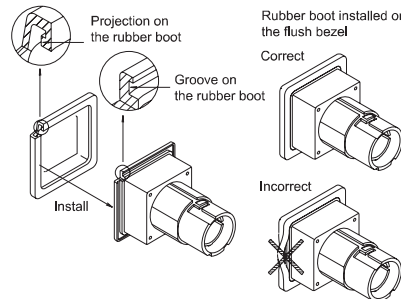

Replacing the Lens

• Removing

Remove the lens assembly (lens, marking plate, and lens holder) from the operator by holding the lens removal tool (MT-101) and pull out.

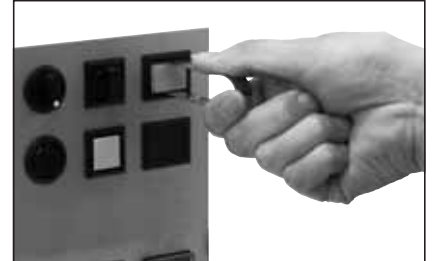

• Installing

Insert the operator in the correct direction.

• For other instructions, refer to L6 series catalog and page 19.