

## FEATURES

- Excellent resistance to corrosive media (stainless steel barrel and rod)
- Mountings integrated in the front and MP4 cap in the rear cover for trunnion mounting
- Compact threaded mount for direct attachment of front or rear covers on machine
- Double acting cylinders with or without pneumatic cushioning

## GENERAL

<b>Detection</b>	Equipped for magnetic position detectors
<b>Fluid</b>	Air or inert gas, filtered, lubricated or not
<b>Operating pressure</b>	[1 bar = 100 kPa]
<b>single acting</b>	2 to 10 bar
<b>double acting</b>	10 bar, max.
<b>Ambient temperature</b>	-20°C to +70°C
<b>Optimal max. speed</b>	≤ 1 m/s (for optimal service life)
<b>Max. speed rate</b>	2 m/s
<b>Standards</b>	ISO 6432



## CONSTRUCTION

<b>Barrel</b>	Non-magnetic stainless steel
<b>Rod</b>	Stainless steel
<b>Front and rear ends</b>	Anodised light alloy (stainless steel: SSC option)
<b>Cushioning seals</b>	PUR (polyurethane)
<b>Cushioning <sup>(a)</sup></b>	Pneumatic, adjustable from both sides with captive screw
<b>Rod nut / neck nut</b>	Galvanised steel
<b>Piston</b>	Light alloy POM (polyacetal) fitted with an annular permanent magnet
<b>Piston seals</b>	PUR (polyurethane)
<b>Dismounting</b>	Cannot be dismounted

Double acting <sup>(a)</sup> cushioning length
Ø 16 mm = 12,5 mm
Ø 20 mm = 17,5 mm
Ø 25 mm = 18 mm

<sup>(a)</sup> CSH option

## HOW TO ORDER

### 15-DIGIT PRODUCT CODE

**G 435 A - S N - - - - A00**

**Thread connection**  
G = ISO 16030

**Product series**  
435

**Revision letter**  
A = Initial release

**Diameter (mm)**  
G = 8                    K = 16  
H = 10                  L = 20  
J = 12                  M = 25

**Rod options 1**  
S = Double acting  
1 = Single acting rod in  
2 = Through rod (double acting)  
3 = Single acting rod out <sup>(1)</sup>  
<sup>(1)</sup> Available in bore size: 12, 16, 20 and 25  
All cylinders delivered with rod nut.

**Rod options 2**  
N = Stainless steel male thread rod end + rod nut

### Options

- A00** = Not cushioned piston, prepared for magnetic detection
  - CSH** = Pneumatic cushioned piston, prepared for magnetic detection <sup>(2)</sup>
  - SSC** = Stainless Steel Covers, FPM Rod Seal, Prepared for Magnetic Detection, Not Cushioned <sup>(3)</sup>
  - AT1** = Cushioned and non cushioned piston, prepared for magnetic detection, certified for ATEX 1/21 zones
  - AT2** = Cushioned and non cushioned piston, prepared for magnetic detection, certified for ATEX 2/22 zones
- <sup>(2)</sup> Available in bore size: 16, 20 and 25 (double acting only)  
<sup>(3)</sup> Available in bore size: 12, 16, 20 and 25 (double acting only) delivered with SS rod nuts

### Recommended standard strokes (mm) <sup>(4)</sup>

Ø mm	connect. Ø	25	50	80	100	160	max. stroke
8	M5	SD	SD	D	D		400
10	M5	SD	SD	D	D		400
12	M5	SDO	SDO	D	D		400
16	M5	SDO	SDO	D	D		400
20	G1/8	SDO	SDO	D	D		400
25	G1/8	SDO	SDO	D	D	D	900

Strokes range available up to "max. stroke" column on the right.  
Please note strokes marked in grey exceed the maximum recommended.

<sup>(4)</sup> Other strokes on request. / Min. stroke: 5 mm  
D = Double acting only / SD = Single & Double acting  
SDO = Single acting rod in + Single acting rod out + Double acting



[Configurator - CAD Files](#)



## POSITION DETECTORS

Magnetic position detectors must be ordered separately: "T" model, [reed switch](#) or [magneto-resistive](#) type

**INSTALLATION**

- The cylinders can be mounted in any position without affecting operation
- Each cylinder is delivered with a neck nut and a rod nut
- Mountings: **catalogue number**

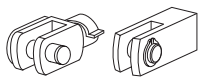
Ø (mm)	 Front or rear flange <b>MF8</b>		 High foot (per unit) <b>MS3</b>		 Rear trunnion	
	steel	st. steel	steel	st. steel	steel	st. steel
8 - 10	<b>P493AG42A000A00</b>	-	<b>P493AG425000A00</b>	-	<b>P493AG42C000A00</b>	-
12 - 16	<b>P493AJ42A000A00</b>	<b>P493AJ42A200A00</b>	<b>P493AJ425000A00</b>	<b>P493AJ425200A00</b>	<b>P493AJ42C000A00</b>	<b>P493AJ42C200A00</b>
20	<b>P493AL42A000A00</b>	<b>P493AL42A200A00</b>	<b>P493AL425000A00</b>	<b>P493AL425200A00</b>	<b>P493AL42C000A00</b>	<b>P493AL42C200A00</b>
25	<b>P493AL42A000A00</b>	<b>P493AL42A200A00</b>	<b>P493AL425000A00</b>	<b>P493AL425200A00</b>	<b>P493AL42C000A00</b>	<b>P493AL42C200A00</b>

Ø (mm)	 female rod clevis ISO 8140 - RP 102 P <b>AP2</b>		 spherical rod end ISO 8139 - RP 103 P <b>AP6</b>		 front neck nut <b>MR3</b>	
	steel	st. steel	steel	st. steel	steel	st. steel
8 - 10	<b>P493AG431000A00</b>	-	<b>P493AG432000A00</b>	-	<b>P493AG42F000A00</b>	-
12 - 16	<b>P493AJ431000A00</b>	<b>P493AJ431200A00</b>	<b>P493AJ432000A00</b>	-	<b>P493AJ42F000A00</b>	<b>P493AJ42F200A00</b>
20	<b>P493AL431000A00</b>	<b>P493AL431200A00</b>	<b>P493AL432000A00</b>	-	<b>P493AL42F000A00</b>	<b>P493AL42F200A00</b>
25	<b>P493A3131000A00</b>	<b>P493AM431200A00</b>	<b>P493A3132000A00</b>	-	<b>P493AL42F000A00</b>	<b>P493AL42F200A00</b>

- Pipe connections G 1/8 have standard thread according to ISO 16030
- Installation/maintenance instructions are included with each cylinder

**DIMENSIONS (mm), WEIGHT (kg)**

[Configurator - CAD Files](#)



**SINGLE-ROD TYPE CYLINDER**

Bare cylinder, single and double acting  
Supplied with front cover nut  
ISO 6432



**THROUGH-ROD TYPE CYLINDER**

Bare cylinder, double acting  
Supplied with front cover nut  
ISO 6432

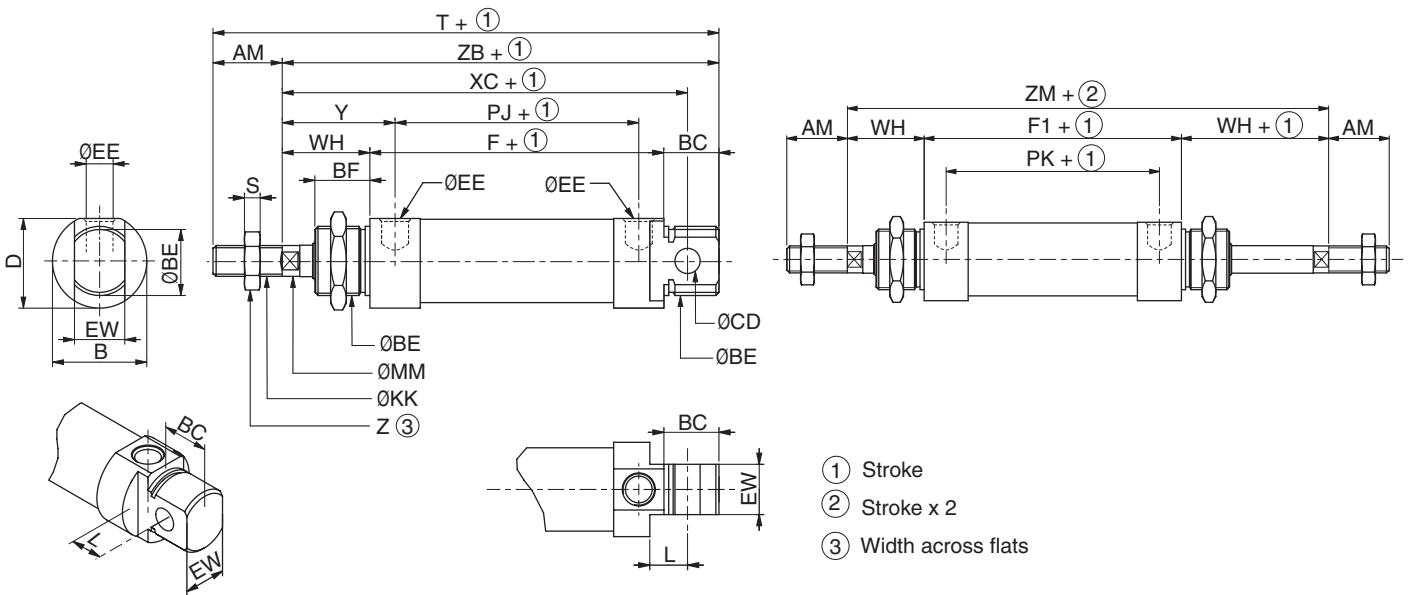

Ø	AM	B	BC	ØBE	BF	ØCD	D	ØEE	EW	F	F1	ØKK	L	MM	PJ	PK	S	T	WH	XC	Y
8	12	16	12	M12x1,25	12	4 H 9	15	M5	8 d 13	46	-	M4x0,7	6	4	34	-	2	86	16	64	22
10	12	16	12	M12x1,25	12	4 H 9	15	M5	8 d 13	46	-	M4x0,7	6	4	34	-	2	86	16	64	22
12	16	19	14	M16x1,5	14	6 H 11	18	M5	12 d 11	48,5	48,5	M6x1	9	6	34,5	34,5	3	100,3	22	75	29
16	16	19	14	M16x1,5	14	6 H 11	18	M5	12 d 11	55	55	M6x1	9	6	41,5	41,5	3	107	22	82	28,5
20	20	27	17,5	M22x1,5	17,5	8 H 11	25,4	G 1/8	16 d 11	63,5	63,5	M8x1,25	12	8	47,3	47,3	4	125	24	95	32
25	22	30	17,5	M22x1,5	17,5	8 H 11	28,5	G 1/8	16 d 11	68,5	68,5	M10x1,25	12	10	52,5	52,5	5	136	28	104	36

Ø	Z	ZB	ZM	weight	
				(4)	(5)
8	7	74	-	0,030	0,020
10	7	74	-	0,030	0,040
12	10	84,5	82,5	0,070	0,090
16	10	91	99	0,100	0,100
20	13	105	111,5	0,170	0,160
25	17	114	124,5	0,200	0,200

(4) Cylinder weight at 0 mm stroke.  
(5) Weight to be added per additional 100 mm length.

NOTE:  
- Single and double acting Rod-In have the same dimensions.  
- Use twice Nominal Stroke for Single Acting Rod Out.  
- The mountings are always delivered separately

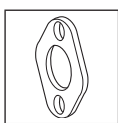

**MOUNTING**  
Front or rear flange  
MF8

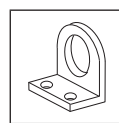

**MOUNTING**

High foot  
Foot mounting are supplied in single units,  
not in pairs  
MS3

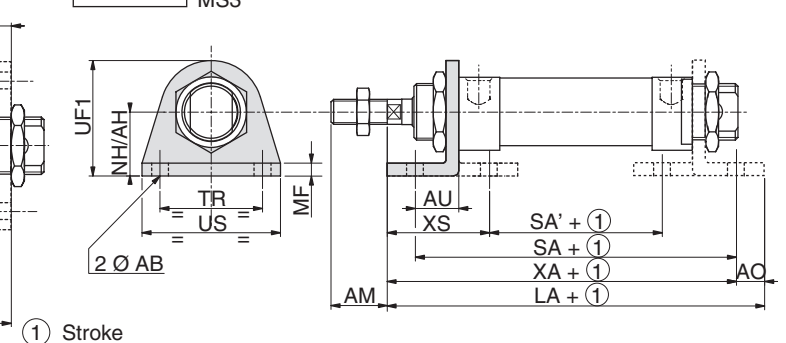
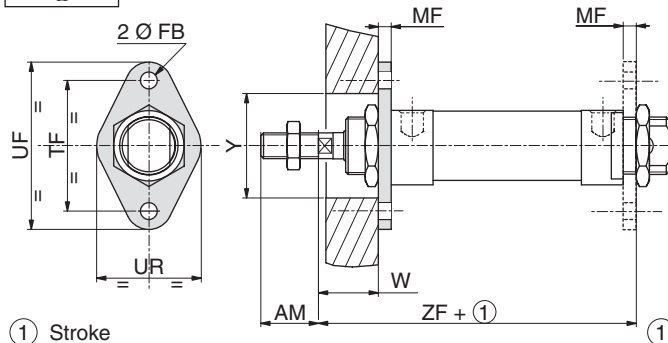

Ø (mm)	AM	ZF	MF	Y	W	ØFB	UF	TF	UR	weight
08	12	65	3	22	13	4,5	40	30	22	0,020
10	12	65	3	22	13	4,5	40	30	22	0,020
12	16	74,5	4	22	18	5,5	52	40	30	0,020
16	16	81,0	4	22	18	5,5	52	40	30	0,020
20	20	92,5	5	31	19	6,6	64	50	40	0,040
25	22	101,5	5	31	23	6,6	64	50	40	0,040

Ø (mm)	UF1	NH/AH	TR	US	MF	ØAB	AM	AU	XS	SA	SA'	XA	LA	AO	weight
08	26	16	25	35	3	4,5	12	11	24	68	30	73	78	5	0,030
10	26	16	25	35	3	4,5	12	11	24	68	30	73	78	5	0,030
12	32	20	32	42	4	5,5	16	14	32	76,5	28,5	84,5	90,5	6	0,050
16	32	20	32	42	4	5,5	16	14	32	83	35	91	97	6	0,050
20	45	25	40	54	5	6,6	20	17	36	97,5	39,5	104,5	113,5	9	0,100
25	45	25	40	54	5	6,6	22	17	40	102,5	44,5	113,5	122,5	9	0,100

01426GB-2016/R02  
Availability, design and specifications are subject to change without notice. All rights reserved.

**DIMENSIONS (mm), WEIGHT (kg)**

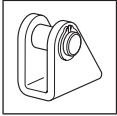

**MOUNTING**  
Rear trunnion

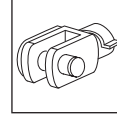

**MOUNTING**  
Female rod clevis  
ISO 8140  
AP2 (steel)

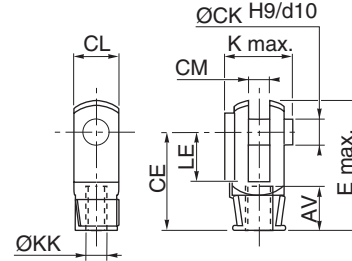
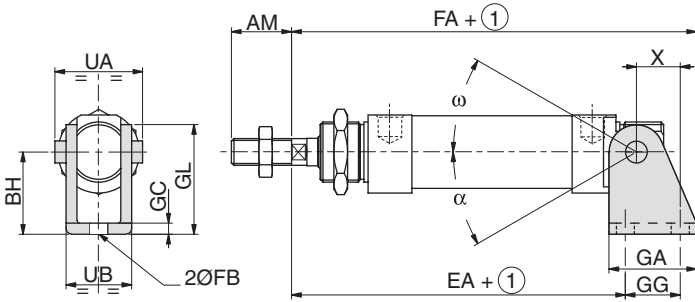

① Stroke

Ø (mm)	AM	BH	EA	FA	FB	GA	GC	GG	GL	UA	UB	X	α	ω	weight
8-10	12	24	62,7	79	4,5	20	2,5	12,5	29	18	13	11,2	7°	160°	0,020
12	16	27	72,5	93	5,5	25	3	16	34	25	18	13,5	50°	180°	0,050
16	16	27	79,5	100	5,5	25	3	16	34	25	18	13,5	47°	180°	0,050
20	20	30	91	117	6,6	32	4	20	40	32	24	16	8°	168°	0,080
25	20	30	100	126	6,6	32	4	20	40	32	24	16	8°	168°	0,080

Ø (mm)	Ø CK	CM	K	AV	LE	CE	CL	ØKK	E max.	weight
8-10	4	4 <sup>+0,01</sup> <sub>+0,01</sub>	11	8	8	16	8	M4x0,7	22,5	0,010
12-16	6	6 <sup>+0,01</sup> <sub>+0,01</sub>	16,5	12	12	24	12	M6x1	33,5	0,020
20	8	8 <sup>+0,01</sup> <sub>+0,01</sub>	22	15	16	32	16	M8x1,25	45	0,050
25	10	10 <sup>+0,01</sup> <sub>+0,01</sub>	26	20	20	40	20	M10x1,25	56	0,100

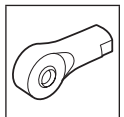

**MOUNTING**  
Spherical rod end  
ISO 8139  
AP6 (steel)

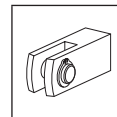

**MOUNTING**  
Female rod clevis  
ISO 8140  
AP2 (stainless steel)

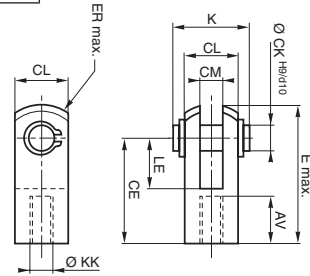
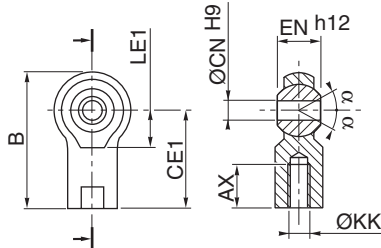

Ø (mm)	AX	B	CE1	ØCN	LE1	ØKK	EN	α	weight
8-10	8	36	27	5	10	M4x0,7	8	4°	0,020
12-16	12	40	30	6	11	M6x1	9	4°	0,030
20	15	48	36	8	13	M8x1,25	12	4°	0,050
25	20	57	43	10	15	M10x1,25	14	4°	0,070

Ø (mm)	CL max.	ØKK	CM	ØCN	E max.	AV min.	LE	CE	weight
8-10	8	M4x0,7	4	4	21	10	8	16	0,005
12-16	12	M6x1	6	6	31	12	12	24	0,015
20	16	M8x1,25	8	8	42	16	16	32	0,036
25	20	M10x1,25	10	10	52	20	20	40	0,075

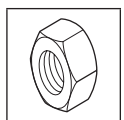

**MOUNTING**  
Front neck nut  
MR3

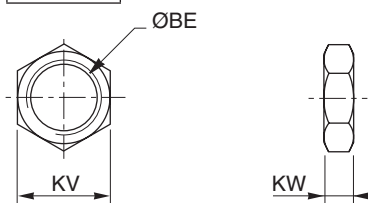

Ø (mm)	ØBE	KV	KW	weight
8	M12x1,25	19	6	0,010
10	M12x1,25	19	6	0,010
12	M16x1,5	19	4	0,010
16	M16x1,5	19	4	0,010
20	M22x1,5	27	5	0,010
25	M22x1,5	27	5	0,010