

SST 02-038-032-10-H-1D1-0.5-J5

Measuring Light Curtains

Measuring Light Curtains

Compatible Receivers:

SSR 02-038-032-10-H-AC2-DN2-0.5-J12

SSR 02-038-032-10-H-AC2-DP2-0.5-J12

SSR 02-038-032-10-H-ANN-DN4-0.5-J12

SSR 02-038-032-10-H-ANN-DP4-0.5-J12



Product Data	
Channel Spacing	10 mm
Function	Transmitter
Operation Mode	Thru Beam
Supply Voltage	18 - 30 V dc
Connection	0.5 m cable with 5 pin, M12 plug
Sensing Range	10 m
Length	380 mm
Active Height	315 mm
Housing	33 x 36 mm

Technical Data	
Supply Voltage	18 - 30 V dc
Reverse Polarity Protected	Yes
Current Consumption	100 mA
Number of Channels	32
Number of Cross Scanning Beams	94
Number of Parallel Beams	32
Distance, Beams Pinch Point	5 mm
Test Input	Yes
Power On Indicator	Green LED
Light Source	Infrared (880 nm)
Profile Dimensions (w x d)	33 x 36 mm
Housing Material, Front Lens	Polycarbonate
Housing Material, Profile	Aluminium (black anodised)
Cable	5 x 0,2 mm ²
Cable Sleeve	PVC Ø 5,9 mm

Environmental Data	
Vibration	10 - 55 Hz, 0,5 mm
Shock	30 g
Operation Temperature	-30 to +60 °C
Storage Temperature	-40 to +80 °C
Sealing Class	IP 67

Approvals

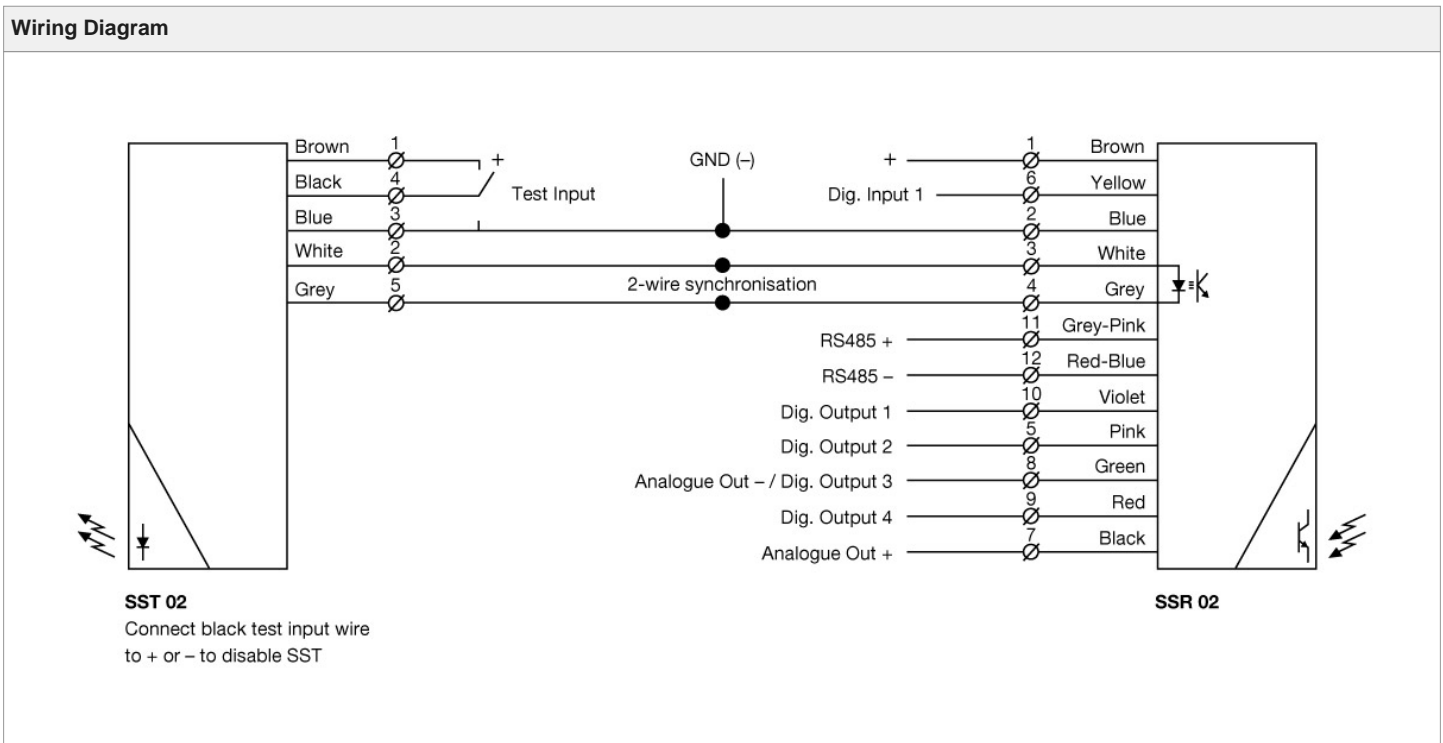



Connections

5 pin, M12

Sensor Plug
(Male)

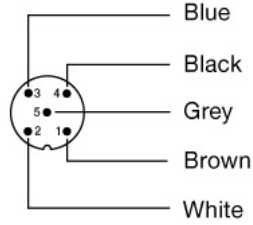
Cable Plug
(Female)



Parallel Displacement



Beam Patterns

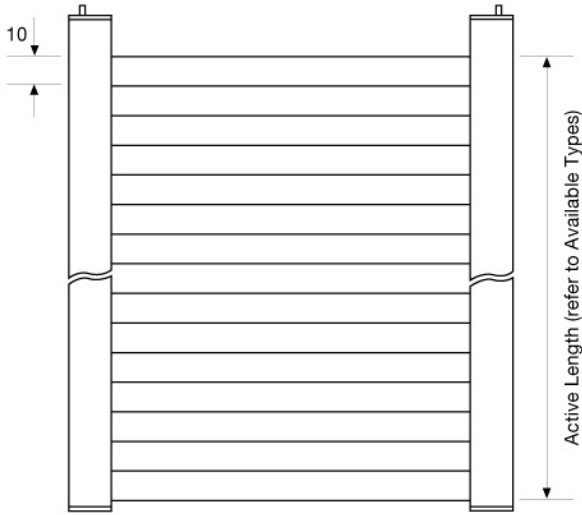

Parallel Beams

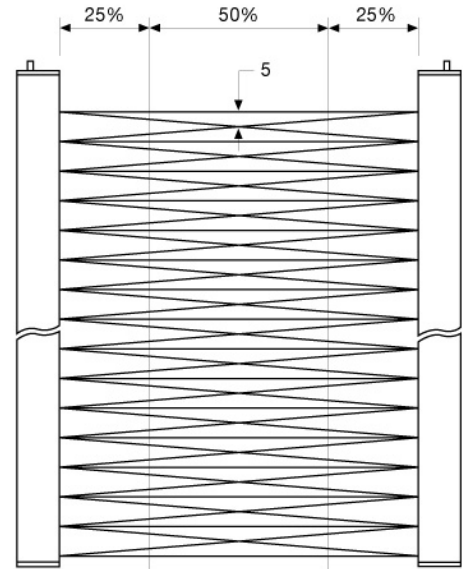

Cross Beams

10 mm channel spacing

Dimensions

