

Disc-Type Handwheels • light metal

24600.0316



Product Description

There are gripping indentations on the rear sides. For all handwheels, the hub is machined, rim is turned and mirror-finished on all sides. The unmachined raw surfaces have been blasted clean. Together with their mirror-polished rim, these handwheels therefore present a finish which generally does not require additional lacquering.

Material

Axle part

- Steel, zinc-plated by galvanization

Handwheel

- Aluminium permanent-mould casting

Cylindrical handle EH 24530

- DIN 7708 - thermosetting plastic (PF 31), black similar to RAL 9005

Assembly

Shaft-end washers EH 22270. for axial fastening.

More information

Further products

- Shaft-End Washers
- Cylindrical Handles, rotating

Drawing

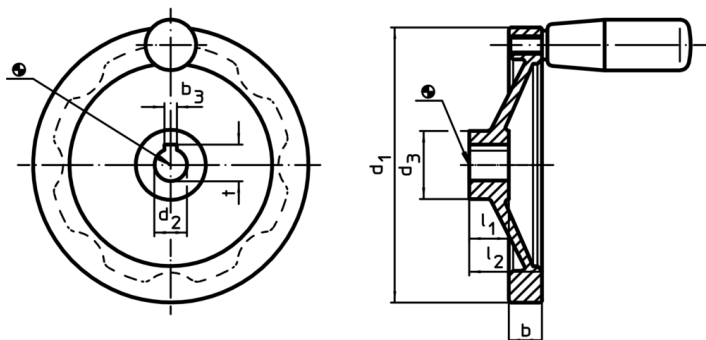

The orientation of the hub keyway may be different than shown in the drawing.

Order information

Dimensions						Hub keyway, DIN 6885 sheet 1		Corresponding cylindrical handle EH 24530.	max.		Art. No.
d ₁	d ₂ H7	d ₃	b	l ₁	l ₂ ~	b ₃	t	[mm]	[°C]	[g]	
[mm]						[mm]		[mm]			
with keyway, with cylindrical handle EH 24530.											
140	16	36	16.5	19	36	5	18.3	23 x M8	110	510	24600.0316

Compliance

RoHS compliant

Contains lead - compliant according to exceptions 6a / 6b / 6c

Contains SVHC substances >0,1% w/w

Contains lead - SVHC list [REACH] as of 10.06.2022

Contains Proposition 65 substances



Lead can cause cancer and reproductive harm from exposure
<https://www.P65Warnings.ca.gov/>

Free from Conflict Minerals

This product does not contain any substances designated as "conflict minerals" such as tantalum, tin, gold or tungsten from the Democratic Republic of Congo or adjacent countries.