

SPIROL[®]

DISC SPRINGS

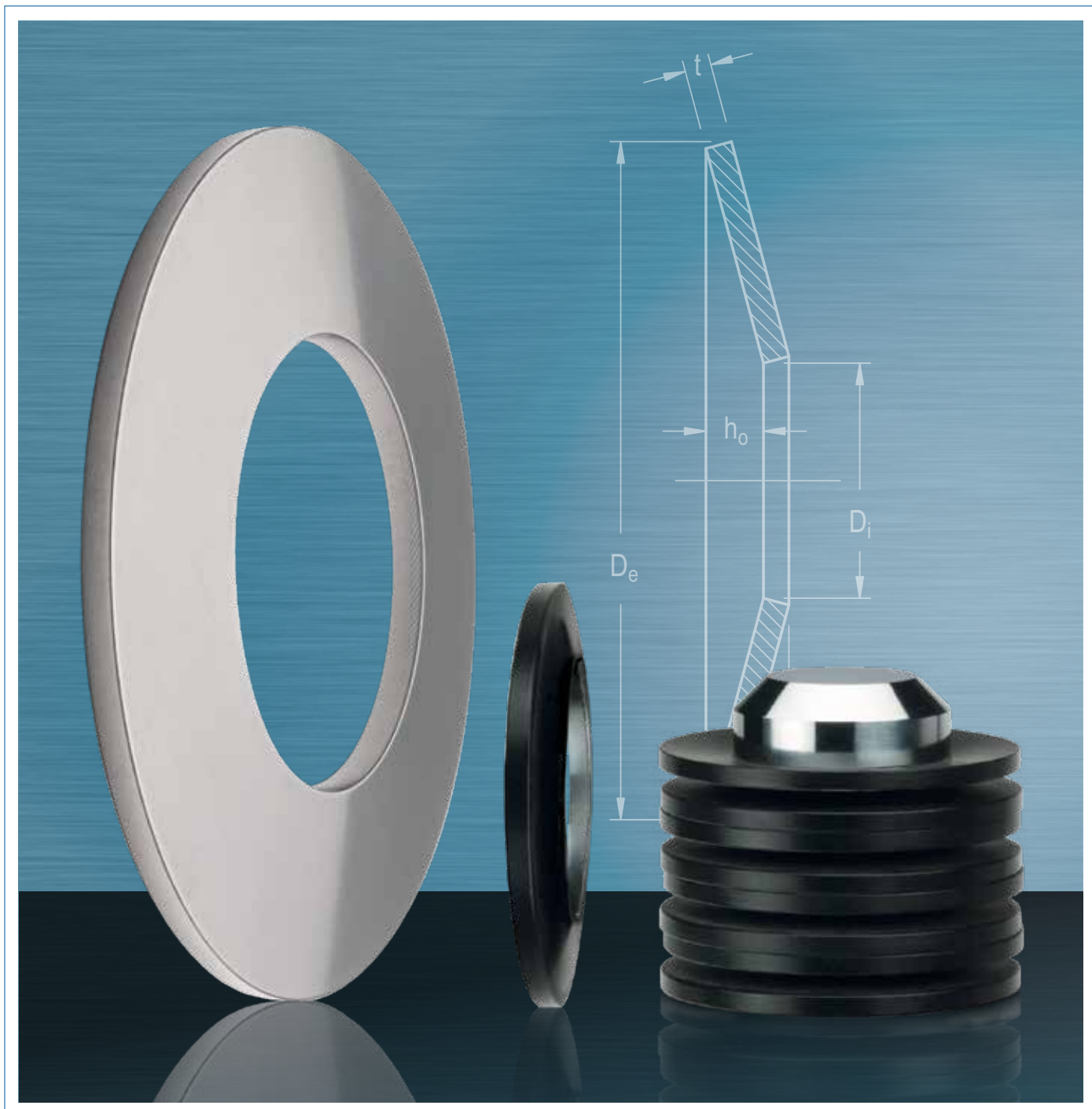



Disc Springs are conically-shaped, washer-type components designed to be axially loaded. What makes Disc Springs unique is that based on the standardized calculations of DIN EN 16984 (formerly DIN 2092), the deflection for a given load is predictable and the minimum life cycle can be determined. Disc Springs can be statically loaded either continuously or intermittently, or dynamically subjected to continuous load cycling. They can be used singly or in multiples, stacked parallel, in series or in a combination thereof.

The advantages of Disc Springs compared to other types of springs include the following:

- **A wide range of load/deflection characteristics**
- **High load capacity with small deflection**
- **Space savings – high load to size ratio**
- **Consistent performance under design loads**
- **Longer fatigue life**
- **Inherent dampening especially with parallel stacking**
- **Flexibility in stack arrangement to meet your application requirements**

DIMENSIONAL DESIGNATIONS

D_e = External Diameter of Disc
 D_i = Internal Diameter of Disc
 l_o = Free Height of Disc
 t = Material Thickness of Disc
 h_o = Free Cone Height of Disc

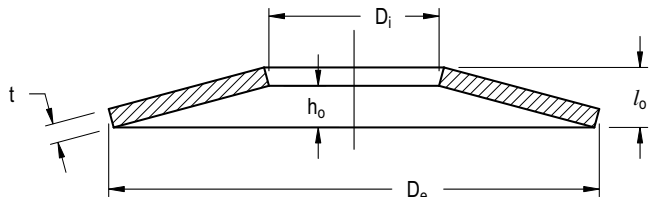

SYMBOLS AND UNITS USED IN THE APPLICATION OF DISC SPRINGS

F = Force or Load Applied	N
s = Deflection of Disc Resulting from an Applied Force	mm
σ = Stress	MPa
E = Modulus of Elasticity	MPa
μ = Poisson's Ratio	—



DISC SPRINGS

STANDARD PRODUCT RANGE

DIN EN 16983 RANGE (formerly DIN 2093) **SPIROL** offers the full range of DIN EN 16983 (formerly DIN 2093) Group 1 and 2 Disc Springs in Series A, B, and C.

SPIROL STANDARD RANGE

In addition to the DIN specified sizes, SPIROL stocks its own standard size range in outside diameters from 8mm to 200mm in order to meet the diverse needs of its customers. SPIROL Standard Disc Springs meet all material, dimensional tolerance, and quality specifications as laid out in DIN EN 16983 (formerly DIN 2093) but in diameter and thickness combinations that are not included in the DIN standard.

STANDARD PRODUCT DEFINITIONS

PROPERTY	GROUP 1	GROUP 2
THICKNESS	<1.25mm	1.25mm up to 6mm
MATERIAL	Code B – Carbon Steel C67S (1.1231) / UNS G10700	Code W – Alloy Steel 51CrV4 (1.8159) / UNS G61500
HARDNESS	HV 425-510 (HRC 43-50)	HRC 42-52 (HV 412-544)
FINISH	Code R – Zinc Phosphate and Oil	

Within each Group there are three Series — A, B, and C. These series are differentiated by material thicknesses and the corresponding force/deflection curves they generate ([see page 2](#)). DIN EN 16983 (formerly DIN 2093) categorizes the three series by the following approximate ratios:

SERIES A	$D_e/t \approx 18$	$h_o/t \approx 0.4$
SERIES B	$D_e/t \approx 28$	$h_o/t \approx 0.75$
SERIES C	$D_e/t \approx 48$	$h_o/t \approx 1.3$

See pages 10-14 for SPIROL's offering.

In addition to the standard offerings, SPIROL offers a line of austenitic **Stainless Steel Disc Springs**.

MATERIAL	Code D – SAE 301 Stainless Steel Full Hard (X10CrNi18-8 No 1.4310 / UNS 30100)
FINISH	Code K – Plain finish, not oiled.

See page 15 for SPIROL's offering.

SPECIALS

SPIROL will work with the customer to develop special Disc Springs to meet the requirements of the application. Factors to take into consideration are forces, working parameters, environment, duty cycle, and required life. SPIROL can provide special dimensions, materials, finishes, and packaging to suit the application.

TO ORDER: Product / $D_e \times D_i \times t$ / material code / finish code

EXAMPLE: DSC 25 x 12.2 x 0.7 BR

THEORETICAL VERSUS MEASURED DEFLECTION

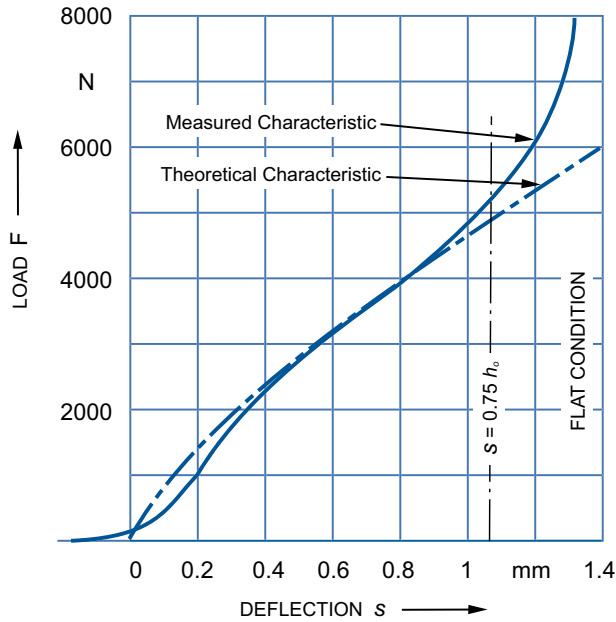

At the lower range, the actual measured curve departs slightly from the theoretical due to residual stresses.

In the mid range – the usual working range – the actual measured deflection very closely coincides with the theoretical.

As the deflection increases, the force moment arm shortens and the force required increases sharply. When the s/h_0 ratio exceeds 0.75, the deviation from the theoretical increases sharply. Accordingly, force/deflection predictability is limited to 75% of total deflection (h_0).

The graph demonstrates the characteristic of a DIN EN 16983 (formerly DIN 2093) Disc Spring, Group 2, Series B 50 x 25.4 x 2.

LOAD/DEFLECTION RELATIONSHIP

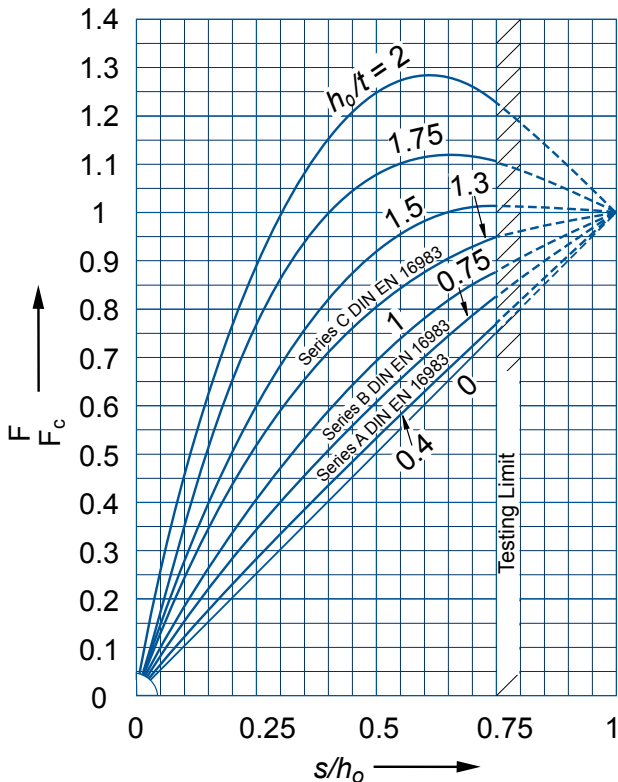

The load/deflection curve of a single Disc Spring is not linear. Its shape depends on the ratio of cone height (h_0) to the thickness (t) (h_0/t). If the ratio is small, 0.4 (DIN Series A), the characteristic is virtually a straight line. The load deflection becomes increasingly curved as the ratio h_0/t increases.

Up to a ratio of 1.5, Disc Springs may safely be taken to the flat position.

At a ratio of 1.5 the curve is flat for a considerable range of deflection. This is a useful consideration for wear compensation.

Above 1.5 the Disc Spring exhibits increasingly regressive characteristics and is capable of push-through and therefore needs to be fully supported.

At ratios over 2, the Disc Springs may invert when taken towards the flat position.

F_c is the design force of the Disc Spring in the flattened position.

CRITICAL STRESS POINTS

When a Disc Spring is loaded, compressive stresses are generated at Points I and IV. Compressive stresses typically act on the upper surface of the Disc.

At the theoretical Point (O) between Points I and IV, the stress must not exceed the yield strength of the Disc material (1,400 – 1,600 MPa for the specified materials) to ensure that there will be no permanent deformation (set).

Tensile stresses at Points II and III are the basis for fatigue life calculations. Tensile stresses typically act on the lower surface of the Disc.

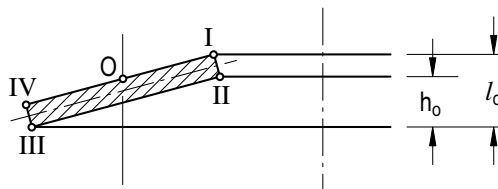

STATIC LOADING

Static loading is defined as carrying a constant load or an occasionally changing load at relatively long time intervals not exceeding ten thousand cycles per design life. In these cases the highest calculated stress at Point O is most critical and should not exceed 1400 - 1600 MPa. The standard range of Disc Springs may be used in static loading conditions without the need to perform theoretical stress calculations. Under these conditions, spring set is not a factor with stresses up to $S = 0.75 h_0$.

DYNAMIC LOADING

One of the key benefits of using DIN Disc Springs is the fact that they can be used in high frequency cyclic applications where fatigue life is a primary concern. In order to realize the maximum benefit of Disc Springs in these applications, there are a few considerations that must be taken into account. In simplified terms, the following techniques will help to ensure that the proper Disc Spring is selected to meet the application requirements.

Understand the Application:

Knowing the loading of the Disc Spring is crucial and requires specifics on such information as preload, working forces, displacement, motion profile, and frequency. Other factors such as the required life, the working temperature, and environmental conditions that may require corrosion protection or cleanliness requirements all will contribute to actual fatigue life and need to be taken into account.

Design to Minimize Stresses:

The fatigue life of a Disc Spring is directly related to the magnitude of stresses developed in the part as it cycles. This applies to both the maximum stress developed during the highest loading part of the cycle as well as the differential stress between the full load and the unloaded or preloaded condition.

Select the Proper Configuration:

In order to minimize the stresses in the part, it is often recommended to utilize the ability of Disc Springs to be oriented into preassembled stacks consisting of Discs in series or parallel. Parallel Discs allow for increased forces for a given size Disc, while Discs in series allow for extended stroke lengths for the application. Both of these will enable the design to minimize the stresses generated in each Disc, thus extending its life.

The process to estimate fatigue life for a Disc Spring is iterative in nature. It is not possible to select a fatigue life and then work backward to arrive at a Disc Spring configuration. The basic steps to estimating fatigue life are as follows:



1. Determine the application requirements in the least loaded state. This should specify the force required for the Disc Springs to exert in the minimally compressed condition.
2. Determine the fully loaded condition of the Disc Spring. This may be specified by a length of travel or an additional load that will be exerted on the Disc Spring.
3. Using the above information, select the configuration of Disc Springs that is likely to work in a static application. This should be based on:
 - Size and Series of the Discs so that a minimum preload of approximately 15% - 20% of the maximum load rating of the Disc is maintained at all times. If this preload is not maintained, it is likely that the Disc Spring will fail at the top ID edge due to reversing compressive stresses.
 - The number of Discs to accommodate required travel. The maximum deflection must not exceed the recommended compression of the Disc.
 - Orientation and quantity of Discs so that the maximum load rating of the Discs is not exceeded during the highest loaded portion of the application.
 - As a general rule, it is better to use larger and lighter duty Disc Springs (Series B or C) in an application than smaller and heavier duty Disc Springs (Series A).
4. Using the selected size of the Disc Spring, determine the compression that will be present at the two extreme conditions. If only forces are known, then the calculations need to be performed to determine what the compression will be. These can either be interpolated from the catalog values or discretely determined using the formulae provided in DIN EN 16984. When using the formulae, both stress and the resulting spring force are determined by the compression of the Disc Spring.
5. For the Disc Spring selected, determine what the critical point of the Disc will be. Depending on the Disc being used, critical points may be on the following edges:
 - Bottom ID Point II
 - Bottom OD Point IIIIn practice, it is best to evaluate the stresses at both points. The highest stressed edge will be the limiting factor for the determining the life of the Disc Spring.
6. Calculate the stresses for both Points II & III at both compression levels. This can be accomplished by interpolating values from the catalog tables, but it is best to utilize the well proven formulae provided in DIN EN 16984.
7. Using the charts in *Figure 1* and *Figure 2*, determine the intersection of the minimum stress on the abscissa and the maximum stress on the ordinate.
8. As a rule, it is best to maintain the 15% - 20% preload on the Disc in the least stressed condition, then minimize the travel required per Disc.

The charts below represent typical expected life of Discs tested under laboratory conditions. To use these charts properly, it is necessary to determine the stresses at both minimum and maximum deflection points of the Disc. Tensile stresses are always the determining factor in causing failure due to fatigue, so as a minimum, evaluating the stresses at Points II and III is required. It is recommended that both be evaluated and the worst case used.

GROUP 1 $t < 1.25\text{mm}$

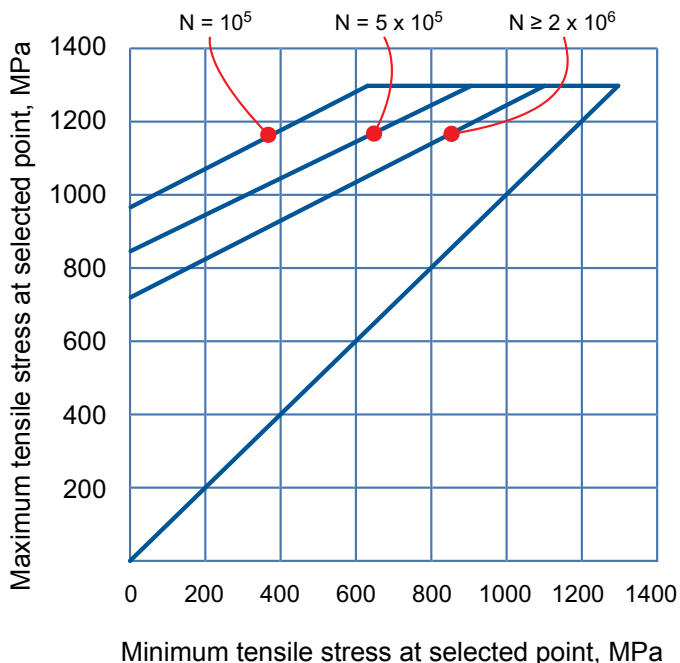

Figure 1

GROUP 2 $1.25\text{mm} \leq t \leq 6.0\text{mm}$

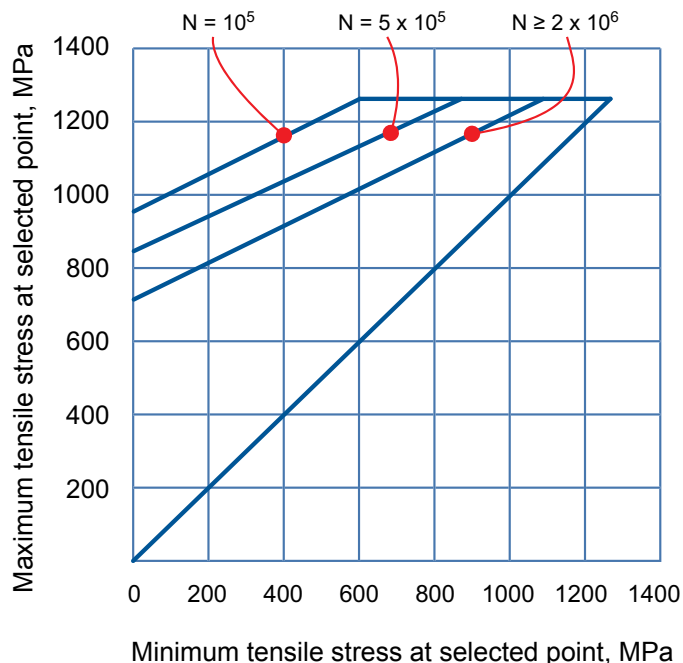

Figure 2

These values are based on laboratory testing using fatigue testing equipment producing sinusoidal loading cycles and resulting in a 99% probability of fatigue life. These figures are valid for single Discs and stacks in series of 10 Discs or fewer utilizing a 15% - 20% preload. Cycling was performed at room temperature and at a rate not to induce significant heating utilizing hardened and highly polished surfaces and guidance.

Stacking Discs in parallel greatly reduces fatigue life as individual Disc deflections may be attenuated due to interactions with the mating Disc, resulting in localized higher stresses. High frequency applications without proper lubrication may also reduce fatigue life due to heat generated from friction. Guiding of stacked Discs, design of the abutting surfaces, and the use of hardened washers is especially important in fatigue applications. Misalignment of mating Discs must be uniform to prevent contact points which will result in stress concentrations and premature failure.

These values only apply to DIN standard materials that are not shot peened. Shot peening Discs can extend the fatigue life of certain Discs, but testing is required to determine the exact benefit.

SIZING AND SELECTION

- Select the Disc with the largest outside diameter (D_o). This reduces the stresses at a given force (F)/deflection (s) ratio and thus enhances fatigue life. An outside (D_o) to inside diameter (D_i) of 1.7 to 2.2 also enhances performance and longevity.
- Select a Disc that achieves the maximum force required at less than 75% of its deflection. Deflection of 75% of cone height (h_o) should be the design maximum. Reducing deflection increases fatigue life.
- Force/deflection curves can be changed by varying the cone height (h_o) to thickness (t) ratio. Curves for Discs may be plotted with the force/deflection data provided on pages **10-15** at 25%, 50%, 75% and 100% of deflection.
- Thicker Discs have greater damping (hysteresis) characteristics.

FATIGUE LIFE

- Fatigue life can be improved by increasing preload and reducing maximum deflection. This will likely require additional Discs in series, but will extend life.
- Shot peening induces favorable compressive stresses on the Disc surface. This reduces the likelihood of fatigue failure due to tensile stresses which generally start on the surface.
- Presetting is defined as a single or repeated compression of a heat treated Disc to the flat condition. The strains induced give rise to plastic deformation, the spring thereby loses height. The remaining free conical height (h_o) results from the residual stresses being at an equilibrium of forces and moments. The Disc will no longer plastically deform during subsequent loading. This allows for higher load stresses and longer fatigue life.

MATERIALS AND FINISHES

- High carbon and alloy steel materials provide excellent strength and endurance life in most applications. The standard coating of zinc phosphate and oil provides adequate protection from humidity and occasional moisture. More effective protective finishes are available, but these tend to wear off in dynamic applications.
- Electroplated finishes should always be avoided. Hydrogen embrittlement poses too great of a risk in highly loaded Discs having a hardness over HRC 40.
- Austenitic stainless steel is a very good choice for static and low cycle applications. It provides high forces and excellent corrosion resistance. This material will continue to work harden with use so cycle life is limited, but creep resistance is good.
- For dynamic applications where corrosion protection is required, precipitation hardening stainless steels are recommended. These steels are nearly as strong as the standard Disc materials and very corrosion resistant.
- At temperatures over approximately 200°F (100°C), standard Disc materials can begin to creep, or take a set. Between 300°F - 400°F (150°C - 200°C) the materials lose their strength and are no longer considered viable. Stainless steels are a bit more temperature resistant, but only up to 575°F (300°C).

ORIENTATION

- Shorter stacks are more efficient. This is particularly important under dynamic loading. Discs at the moving end of the stack are overdeflected whereas Discs at the opposite end are underdeflected. This results from the friction between the individual Discs as well as the Discs and the guiding mandrel or sleeve. Use of the largest practical outside diameter Discs will reduce the number of individual Discs and total stack height. It is recommended that total stack height not exceed three times the external Disc diameter (D_o) or ten total Discs.
- When Discs are used in parallel, the following factors should be considered:
 1. In dynamic applications, the generation of heat;
 2. The relationship between loading and unloading forces due to friction;
 3. Hysteresis, the increased damping resulting from friction between the Discs; and
 4. Lubrication – A must in parallel Disc applications.
- Lubrication is required for the efficient use and extended life of Discs. In moderate applications, a solid lubricant such as molybdenum disulfide will generally suffice. In severe and corrosive applications, an oil or grease lubricant housed in a chamber may be required.
- Hardened thrust washers will alleviate surface damage/indentation when Discs are used in conjunction with soft materials.

DISC SPRINGS – STACKING

STACKING

Stacking individual Disc Springs provides the designer with:

- A wide range of possible force/deflection combinations;
- The ability to design application specific load curves – both progressive and regressive; and
- The opportunity to design a range of dampening characteristics into the design.

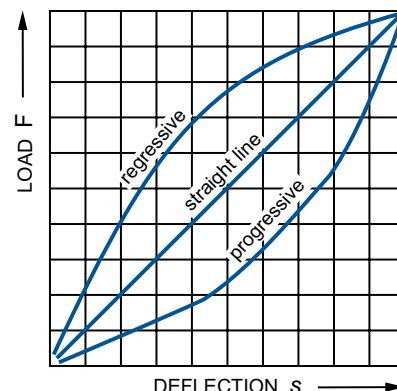

METHODS OF STACKING

IN PARALLEL

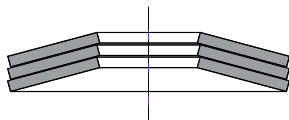

Deflection: Same as single Disc

Force: Single Disc multiplied by the number of Discs

IN SERIES

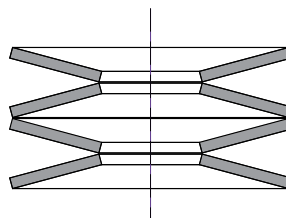

Deflection: Single Disc multiplied by the number of Discs

Force: Same as single Disc

IN COMBINATION

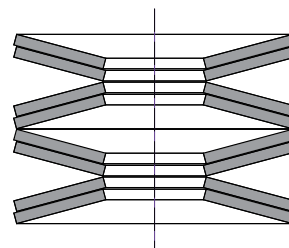

Deflection: Single Disc multiplied by the number of Discs in series

Force: Single Disc multiplied by the number of parallel Discs in a set

Consideration needs to be given to the friction between the parallel Disc surfaces. A reasonable allowance is 2 - 3% of the force for each sliding surface – a greater force for loading and a lesser force for unloading. Discs in parallel should be well lubricated and it is suggested that the number of Discs in a parallel set be limited to a maximum of 4 to reduce the deviation from calculated to measured characteristics. Discs in parallel have increased self-dampening (hysteresis) characteristics.

STACK CONSTRUCTION

EVEN NUMBER OF DISCS

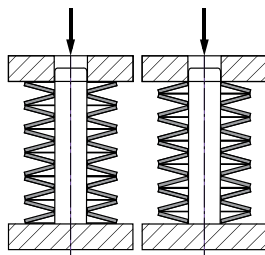

RIGHT **WRONG**

ODD NUMBER OF DISCS

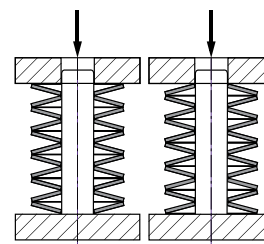

RIGHT **WRONG**

It is normally desirable to have both ends rest on the larger outer edge of the Disc. With an uneven number of pairs in a stack, this is not possible. In this case, the end resting on the outer edge should be arranged to be on the end on which the force is applied – the moving end of the stack.

DISC SPRINGS – STACKING

PRE-STACKED

SPIROL offers pre-stacked Disc Springs (greased or ungreased) in custom configurations packaged in shrink wrap with a perforated tab for ease of insertion into the assembly. This saves time and helps to mistake-proof the assembly process.



STACK GUIDANCE

Stacks need to be guided to keep the Discs in position. The preferred method is internal, such as a rod through the inside diameter. In case of external guidance, a sleeve is suggested. In either case, the guiding component should be case hardened to 58 HRC with a depth not less than 0.6mm and have a ground finish.

Since the diameter of the Discs change when compressed, the following clearance values are recommended:

D_e or D_i (mm)	CLEARANCE (mm)
Up to 16	0.2
Over 16 to 20	0.3
Over 20 to 26	0.4
Over 26 to 31.5	0.5
Over 31.5 to 50	0.6
Over 50 to 80	0.8
Over 80 to 140	1.0
Over 140 to 250	1.6

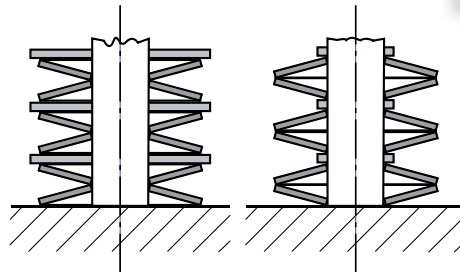

RIGHT

WRONG

The stability of a Disc with a thickness of 1mm or less can present a problem at the bearing surfaces. In such cases, the use of intermediate flat Discs is recommended with outside diameter contact.

PROGRESSIVE LOAD CURVES

Progressive loading can be obtained by assembling stacks in which Discs will deflect consecutively when loaded. Generally, this is done by 1) stacking single, double and triple parallel sets in series, or 2) stacking Discs of various thickness in series. It is, however, necessary to provide a means to limit the compression of the weaker Disc to avoid overstressing while the stronger Discs are still in process of compression.

DISC STACKS WITH PROGRESSIVE CHARACTERISTIC LOAD CURVES AND STROKE LIMITERS TO AVOID OVERLOAD

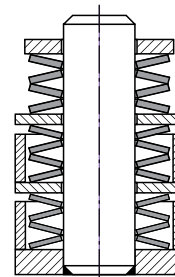

WASHERS AND RINGS

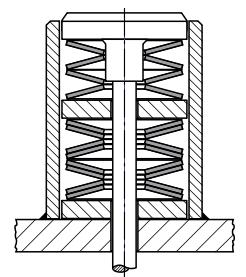

SLEEVE AND STOP

DIAMETER TOLERANCE

Outside Diameter: D_e h12
 Inside Diameter: D_i H12

Concentricity: $D_e \leq 50\text{mm}$ $2 \cdot IT 11$
 $D_e > 50\text{mm}$ $2 \cdot IT 12$

D_e or D_i RANGE mm	D_e TOLERANCE MINUS mm	D_i TOLERANCE PLUS mm	CONCENTRICITY TOLERANCE ¹
3 to 6	0.12	0.12	0.15
Over 6 to 10	0.15	0.15	0.18
Over 10 to 18	0.18	0.18	0.22
Over 18 to 30	0.21	0.21	0.26
Over 30 to 50	0.25	0.25	0.32
Over 50 to 80	0.30	0.30	0.60
Over 80 to 120	0.35	0.35	0.70
Over 120 to 180	0.40	0.40	0.80
Over 180 to 250	0.46	0.46	0.92

1) In reference to Outside Diameter D_e

THICKNESS TOLERANCE (t)

THICKNESS RANGE mm	TOLERANCE mm	
	PLUS	MINUS
From 0.2 to 0.6	0.02	0.06
Over 0.6 to under 1.25	0.03	0.09
From 1.25 to 3.8	0.04	0.12
Over 3.8 to 6	0.05	0.15

FREE OVER-ALL HEIGHT (l_o) TOLERANCE

THICKNESS RANGE (t) mm	TOLERANCE mm	
	PLUS	MINUS
Less than 1.25	0.10	0.05
From 1.25 to 2	0.15	0.08
Over 2 to 3	0.20	0.10
Over 3 to 6	0.30	0.15

SPRING FORCE TOLERANCE

The following deviations apply for normal applications:

The static load (F) of a single Disc shall be determined for a Disc in the loaded state using a suitable lubricant. The pressure plates between which the Disc is compressed must be hardened, ground and polished.

THICKNESS (t) mm	PERMISSIBLE DEVIATION in load F at $s = 0.75 h_o$ as a percentage
Less than 1.25	+ 25 % - 7.5 %
From 1.25 to 3	+ 15 % - 7.5 %
Over 3 to 6	+ 10 % - 5 %

DISC SPRINGS TO DIN EN 16983 (formerly DIN 2093)

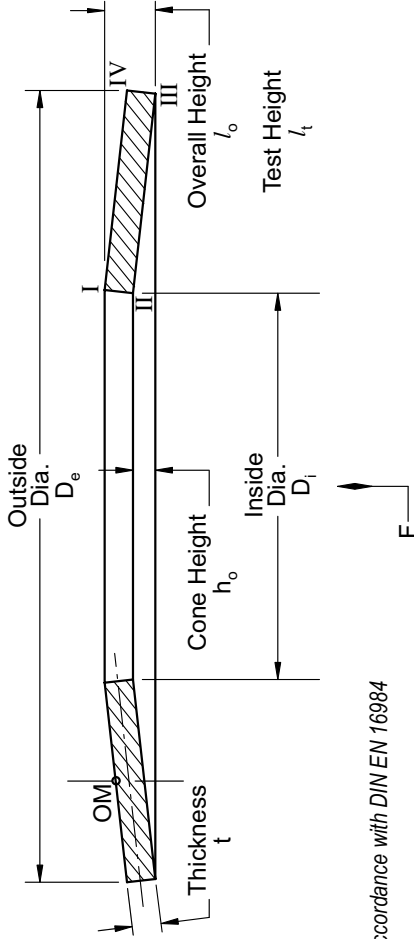

Deflection s in mm
Force F in N

Stress σ in MPa

Values calculated in accordance with DIN EN 16984 (formerly DIN 2092)

STANDARD MATERIALS	
B	"t" less than 1.25mm High Carbon Steel HV 425 - 510 HRC 43 - 50
W	"t" 1.25mm and thicker Alloy Steel HV 412 - 544 HRC 42 - 52
STANDARD FINISH	
R	Phosphate coated, oiled

Refer to page 15 for SPIROL Stainless Steel Disc Springs.

TO ORDER: Product / $D_e \times D_i \times t$ / material code / finish code
EXAMPLE: DSC 25 x 12.2 x 0.7 BR

DIN Series	Design Force, Deflection and Stresses Based on $E = 206 \text{ kMPa}$ and $\mu = 0.3$																												
	Dimensions				Preload, $s = 0.15 h_o$			$s = 0.25 h_o$			$s = 0.5 h_o$			$F_t @ l_o - 0.75 h_o$			$s = h_o$												
	D_e	D_i	t	l_o	h_o	h_o/t	s	l_t	F	σ_{II}	σ_{III}	s	l_t	F	σ_{II}	σ_{III}	s	l_t	F	σ_{II}	σ_{III}	s	F	σ_{OM}					
	8.0	3.2	0.30	0.55	0.25	0.83	0.04	0.51	29	113	247	0.06	0.49	46	207	401	0.13	0.43	79	511	750	0.19	0.36	104	912	1,046	0.25	126	-1,332
	8.0	3.2	0.40	0.60	0.20	0.50	0.03	0.57	43	212	214	0.05	0.55	69	365	350	0.10	0.50	130	792	666	0.15	0.45	186	1,281	949	0.20	238	-1,421
	8.0	3.2	0.50	0.70	0.20	0.40	0.03	0.67	79	299	249	0.05	0.65	128	511	408	0.10	0.60	246	1,083	782	0.15	0.55	357	1,717	1,123	0.20	465	-1,776
C	8.0	4.2	0.20	0.45	0.25	1.25	0.04	0.41	14	-7	253	0.06	0.39	21	8	409	0.13	0.33	33	114	753	0.19	0.26	39	319	1,034	0.25	42	-1,003
B	8.0	4.2	0.30	0.55	0.25	0.83	0.04	0.51	33	99	308	0.06	0.49	52	184	501	0.13	0.43	89	467	938	0.19	0.36	118	847	1,312	0.25	142	-1,505
A	8.0	4.2	0.40	0.60	0.20	0.50	0.03	0.57	48	198	268	0.05	0.55	78	343	439	0.10	0.50	147	749	837	0.15	0.45	210	1,218	1,194	0.20	269	-1,605
	10.0	3.2	0.30	0.65	0.35	1.17	0.05	0.60	34	39	234	0.09	0.56	51	90	378	0.18	0.48	82	308	697	0.26	0.39	98	652	957	0.35	108	-1,147
	10.0	3.2	0.50	0.85	0.35	0.70	0.05	0.80	104	253	302	0.09	0.76	165	447	492	0.18	0.68	296	1,021	925	0.26	0.59	404	1,721	1,299	0.35	500	-1,911
	10.0	4.2	0.40	0.70	0.30	0.75	0.05	0.66	50	134	249	0.08	0.63	79	241	405	0.15	0.55	140	570	760	0.23	0.48	189	988	1,066	0.30	232	-1,384
	10.0	4.2	0.50	0.75	0.25	0.50	0.04	0.71	68	208	221	0.06	0.69	110	359	361	0.13	0.63	206	778	688	0.19	0.56	294	1,260	981	0.25	377	-1,441
	10.0	4.2	0.60	0.85	0.25	0.42	0.04	0.81	111	277	250	0.06	0.79	182	473	410	0.13	0.73	347	1,008	785	0.19	0.66	502	1,604	1,125	0.25	662	-1,730
C	10.0	5.2	0.25	0.55	0.30	1.20	0.05	0.51	20	2	235	0.08	0.48	30	21	380	0.15	0.40	48	133	702	0.23	0.32	58	336	965	0.30	63	-957
B	10.0	5.2	0.40	0.70	0.30	0.75	0.05	0.66	56	124	298	0.08	0.63	88	224	485	0.15	0.55	155	539	912	0.23	0.47	209	943	1,281	0.30	257	-1,531
A	10.0	5.2	0.50	0.75	0.25	0.50	0.04	0.71	75	198	266	0.06	0.69	122	343	435	0.13	0.63	228	749	829	0.19	0.56	325	1,218	1,182	0.25	418	-1,595
	12.0	4.2	0.40	0.80	0.40	1.00	0.06	0.74	55	76	238	0.10	0.70	85	149	385	0.20	0.60	141	411	714	0.30	0.50	178	786	988	0.40	206	-1,228
	12.0	4.2	0.50	0.90	0.40	0.80	0.06	0.84	91	158	266	0.10	0.80	143	285	432	0.20	0.70	249	683	809	0.30	0.60	331	1,193	1,130	0.40	402	-1,535
	12.0	5.2	0.50	0.90	0.40	0.80	0.06	0.84	96	137	303	0.10	0.80	150	251	493	0.20	0.70	263	611	923	0.30	0.60	350	1,080	1,291	0.40	424	-1,619
	12.0	5.2	0.60	0.95	0.35	0.58	0.05	0.90	122	213	279	0.09	0.86	196	372	455	0.18	0.78	361	828	863	0.26	0.69	506	1,367	1,222	0.35	641	-1,700
	12.0	6.2	0.50	0.85	0.35	0.70	0.05	0.80	84	139	291	0.09	0.76	134	249	475	0.18	0.68	239	582	894	0.26	0.59	326	1,001	1,259	0.35	404	-1,544
	12.0	6.2	0.60	0.95	0.35	0.58	0.05	0.90	133	204	325	0.09	0.86	214	358	531	0.18	0.78	394	801	1,007	0.26	0.69	552	1,329	1,429	0.35	699	-1,853

DISC SPRINGS TO DIN EN 16983 (formerly DIN 2093)

DIN Series	Dimensions											Design Force, Deflection and Stresses Based on E = 206 kMPa and $\mu = 0.3$																	
	D _e	D _i	t	l ₀	h ₀	h ₀ /t	Preload, s = 0.15 h ₀				s = 0.25 h ₀				s = 0.5 h ₀				F _t @ l ₀ - 0.75 h ₀				s = h ₀						
							s	l _t	F	σ_{th}	σ_{tm}	s	l _t	F	σ_{th}	σ_{tm}	s	l _t	F	σ_{th}	σ_{tm}	s	l _t	F	σ_{th}	σ_{tm}	s	F	σ_{0M}
	23.0	8.2	0.70	1.50	0.80	1.14	0.12	1.38	183	37	245	0.20	1.30	279	87	397	0.40	1.10	448	295	733	0.60	0.90	544	626	1,007	0.80	602	-1,173
	23.0	8.2	0.80	1.55	0.75	0.94	0.11	1.44	214	42	237	0.19	1.36	332	175	384	0.38	1.18	560	457	714	0.56	0.99	719	846	991	0.75	842	-1,257
	23.0	8.2	0.90	1.70	0.80	0.89	0.12	1.58	311	125	277	0.20	1.50	486	233	449	0.40	1.30	829	589	837	0.60	1.10	1,078	1,066	1,164	0.80	1,279	-1,508
	23.0	10.2	0.90	1.65	0.75	0.83	0.11	1.54	295	115	289	0.19	1.46	463	213	469	0.38	1.28	802	531	877	0.56	1.09	1,058	953	1,225	0.75	1,273	-1,500
	23.0	10.2	1.00	1.70	0.70	0.70	0.11	1.60	339	158	277	0.18	1.53	538	282	451	0.35	1.35	964	655	849	0.53	1.18	1,315	1,119	1,195	0.70	1,629	-1,556
	23.0	12.2	1.25	1.85	0.60	0.48	0.09	1.76	532	231	304	0.15	1.70	863	399	497	0.30	1.55	1,630	868	949	0.45	1.40	2,331	1,404	1,356	0.60	3,000	-1,834
	23.0	12.2	1.50	2.10	0.60	0.40	0.09	2.01	875	308	344	0.15	1.95	1,432	527	565	0.30	1.80	2,748	1,124	1,085	0.45	1.65	3,986	1,788	1,560	0.60	5,184	-2,200
C	25.0	12.2	0.70	1.60	0.90	1.29	0.14	1.47	219	-13	309	0.23	1.38	331	4	499	0.45	1.15	515	136	919	0.68	0.92	600	396	1,259	0.90	635	-1,238
B	25.0	12.2	0.90	1.60	0.70	0.78	0.11	1.50	233	99	239	0.18	1.43	367	181	389	0.35	1.25	644	440	730	0.53	1.07	862	776	1,023	0.70	1,050	-1,238
A	25.0	12.2	1.50	2.05	0.55	0.37	0.08	1.97	634	249	239	0.14	1.91	1,040	425	393	0.28	1.78	2,007	898	757	0.41	1.64	2,926	1,419	1,091	0.55	3,821	-1,622
	28.0	10.2	0.80	1.75	0.95	1.19	0.14	1.61	229	23	232	0.24	1.51	348	62	375	0.48	1.28	553	239	692	0.71	1.04	662	532	950	0.95	723	-1,078
	28.0	10.2	1.00	2.00	1.00	1.00	0.15	1.85	398	84	278	0.25	1.75	615	165	451	0.50	1.50	1,022	459	837	0.75	1.25	1,289	880	1,158	1.00	1,486	-1,419
	28.0	10.2	1.25	2.25	1.00	0.80	0.15	2.10	654	176	312	0.25	2.00	1,030	319	507	0.50	1.75	1,799	765	949	0.75	1.50	2,394	1,340	1,326	1.00	2,902	-1,774
	28.0	10.2	1.50	2.20	0.70	0.47	0.11	2.10	617	247	211	0.18	2.03	1,003	424	346	0.35	1.85	1,899	911	660	0.53	1.68	2,723	1,461	943	0.70	3,511	-1,490
	28.0	12.2	1.00	1.95	0.95	0.95	0.14	1.81	380	80	288	0.24	1.71	590	156	467	0.48	1.48	992	425	870	0.71	1.24	1,268	807	1,208	0.95	1,482	-1,415
	28.0	12.2	1.25	2.10	0.85	0.68	0.13	1.97	530	169	277	0.21	1.89	844	300	451	0.43	1.68	1,519	691	849	0.64	1.46	2,083	1,172	1,196	0.85	2,590	-1,583
	28.0	12.2	1.50	2.25	0.75	0.50	0.11	2.14	709	235	261	0.19	2.06	1,149	406	426	0.38	1.88	2,159	883	812	0.56	1.69	3,077	1,431	1,157	0.75	3,949	-1,676
C	28.0	14.2	0.80	1.80	1.00	1.25	0.15	1.65	287	-7	319	0.25	1.55	435	13	515	0.50	1.30	681	154	950	0.75	1.05	801	422	1,304	1.00	859	-1,282
B	28.0	14.2	1.00	1.80	0.80	0.80	0.12	1.68	303	94	254	0.20	1.60	476	174	414	0.40	1.40	832	429	776	0.60	1.20	1,107	765	1,086	0.80	1,342	-1,282
	28.0	14.2	1.25	2.10	0.85	0.68	0.13	1.97	570	161	315	0.21	1.89	907	287	513	0.43	1.68	1,634	667	968	0.64	1.46	2,240	1,138	1,365	0.85	2,785	-1,702
A	28.0	14.2	1.50	2.15	0.65	0.43	0.10	2.05	633	216	246	0.16	1.99	1,033	371	403	0.33	1.83	1,970	795	772	0.49	1.66	2,841	1,274	1,106	0.65	3,680	-1,562
C	31.5	16.3	0.80	1.85	1.05	1.31	0.16	1.69	255	-19	278	0.26	1.59	384	-9	448	0.53	1.33	594	94	825	0.79	1.06	687	308	1,130	1.05	722	-1,077
B	31.5	16.3	1.25	2.15	0.90	0.72	0.14	2.02	498	124	278	0.23	1.93	791	224	449	0.45	1.70	1,409	530	844	0.68	1.47	1,913	917	1,187	0.90	2,359	-1,442
	31.5	16.3	1.50	2.40	0.90	0.60	0.14	2.27	785	186	307	0.23	2.18	1,260	326	501	0.45	1.95	2,314	734	950	0.68	1.73	3,230	1,223	1,346	0.90	4,077	-1,730
A	31.5	16.3	1.75	2.45	0.70	0.40	0.11	2.35	850	223	243	0.18	2.28	1,391	382	399	0.35	2.10	2,669	814	766	0.53	1.92	3,871	1,296	1,102	0.70	5,036	-1,570
	31.5	16.3	2.00	2.75	0.75	0.38	0.11	2.64	1,342	282	292	0.19	2.56	2,199	481	480	0.38	2.38	4,239	1,020	924	0.56	2.19	6,173	1,615	1,331	0.75	8,054	-1,923
	34.0	12.3	1.00	2.20	1.20	1.20	0.18	2.02	386	22	249	0.30	1.90	587	63	403	0.60	1.60	930	250	742	0.90	1.30	1,110	563	1,018	1.20	1,208	-1,153
	34.0	12.3	1.25	2.45	1.20	0.96	0.18	2.27	610	98	276	0.30	2.15	946	188	448	0.60	1.85	1,587	500	833	0.90	1.55	2,024	938	1,154	1.20	2,359	-1,442
	34.0	12.3	1.50	2.70	1.20	0.80	0.18	2.52	919	173	304	0.30	2.40	1,447	313	493	0.60	2.10	2,527	750	923	0.90	1.80	3,363	1,313	1,290	1.20	4,076	-1,730
	34.0	14.3	1.25	2.40	1.15	0.92	0.17	2.23	586	93	284	0.29	2.11	913	177	461	0.58	1.83	1,546	466	858	0.86	1.54	1,993	868	1,193	1.15	2,347	-1,435
	34.0	14.3	1.50	2.55	1.05	0.70	0.16	2.39	770	167	274	0.26	2.29	1,224	297	447	0.53	2.03	2,192	687	841	0.79	1.76	2,990	1,172	1,183	1.05	3,704	-1,572
	34.0	16.3	1.50	2.55	1.05	0.70	0.16	2.39	812	158	304	0.26	2.29	1,291	283	495	0.53	2.03	2,313	660	933	0.79	1.76	3,155	1,131	1,313	1.05	3,908	-1,658
	34.0	16.3	2.00	2.85	0.85	0.43	0.13	2.72	1,284	260	274	0.21	2.64	2,097	445	449	0.43	2.43	4,003	952	860	0.64	2.21	5,783	1,520	1,234	0.85	7,498	-1,790
C	35.5	18.3	0.90	2.05	1.15	1.28	0.17	1.88	303	-12	264	0.29	1.76	458	2	427	0.58	1.48	712	108	786	0.86	1.19	832	320	1,078	1.15	884	-1,042
B	35.5	18.3	1.25	2.25	1.00	0.80	0.15	2.10	464	91	251	0.25	2.00	731	168	409	0.50	1.75	1,277	416	766	0.75	1.50	1,699	743	1,073	1.00	2,059	-1,258
A	35.5	18.3	2.00	2.80	0.80	0.40	0.12	2.68	1,139	230	249	0.20	2.60	1,864	393	409	0.40	2.40	3,576	837	785	0.60	2.20	5,187	1,332	1,128	0.80	6,747	-1,611
	40.0	14.3	1.25	2.65	1.40	1.12	0.21	2.44	591	44	251	0.35	2.30	904	98	406	0.70	1.95	1,459	319	750	1.05	1.60	1,780	664	1,033	1.40	1,984	-1,213
	40.0	14.3	1.50	2.80	1.30	0.87	0.20	2.61	760	118	245	0.33	2.48	1,188	218	398	0.65	2.15	2,040	542	743	0.98	1.83	2,668	973	1,034	1.30	3,184	-1,351
	40.0	14.3	2.00	3.05	1.05	0.53	0.16	2.89	1,112	227	214	0.26	2.79	1,800	393	349	0.53	2.53	3,363	855	664	0.79	2.26	4,769	1,387	943	1.05	6,096	-1,455

DISC SPRINGS TO DIN EN 16983 (formerly DIN 2093)

DIN Series	Design Force, Deflection and Stresses Based on E = 206 kMPa and $\mu = 0.3$																																								
	Dimensions					Preload, $s = 0.15 h_0$					$s = 0.25 h_0$					$s = 0.5 h_0$					$F_t @ l_0 - 0.75 h_0$					$s = h_0$															
	D_e	D_i	t	l_0	h_0	h_0/t	s	l_t	F	σ_{th}	σ_{tm}	σ_{im}	s	l_t	F	σ_{th}	σ_{tm}	σ_{im}	s	l_t	F	σ_{th}	σ_{tm}	σ_{im}	s	l_t	F	σ_{th}	σ_{tm}	σ_{im}	s	l_t	F	σ_{th}	σ_{tm}	σ_{im}	s	l_t	F	σ_{th}	σ_{tm}
	40.0	16.3	1.50	2.80	1.30	0.87	0.20	2.61	783	107	265	0.33	2.48	1,224	199	430	802	0.65	2.15	2,102	503	802	0.98	1.83	2,749	911	1,118	1.30	3,281	-1,392											
	40.0	16.3	2.00	3.10	1.10	0.55	0.17	2.94	1,222	216	246	0.28	2.83	1,972	375	402	764	0.55	2.55	3,663	825	764	0.83	2.29	5,169	1,349	1,084	1.10	6,580	-1,571											
	40.0	18.3	2.00	3.15	1.15	0.58	0.17	2.98	1,355	209	285	0.29	2.86	2,182	365	466	883	0.58	2.58	4,030	810	883	0.86	2.29	5,656	1,338	1,052	1.15	7,171	-1,712											
C	40.0	20.4	1.00	2.30	1.30	1.30	0.20	2.11	375	-15	261	0.33	1.98	565	-4	422	776	0.65	1.65	876	98	776	0.86	1.32	1,017	305	1,063	1.30	1,072	-1,024											
B	40.0	20.4	1.50	2.65	1.15	0.77	0.17	2.48	702	108	265	0.29	2.36	1,109	196	431	810	0.58	2.08	1,953	474	810	0.86	1.79	2,621	835	1,136	1.15	3,201	-1,359											
	40.0	20.4	2.00	3.10	1.10	0.55	0.17	2.94	1,348	203	296	0.28	2.83	2,175	354	484	920	0.55	2.55	4,041	783	920	0.83	2.28	5,701	1,288	1,307	1.10	7,258	-1,733											
A	40.0	20.4	2.25	3.15	0.90	0.40	0.14	3.02	1,428	229	246	0.23	2.93	2,336	392	403	774	0.68	2.47	6,500	835	774	0.68	2.47	6,500	1,328	1,112	0.90	8,456	-1,595											
	40.0	20.4	2.50	3.45	0.95	0.38	0.14	3.31	2,045	275	284	0.24	3.21	3,351	470	466	896	0.71	2.74	9,390	997	896	0.71	2.74	9,390	1,579	1,290	0.95	12,243	-1,871											
C	45.0	22.4	1.25	2.85	1.60	1.28	0.24	2.61	689	-13	307	0.40	2.45	1,041	4	497	914	0.80	2.05	1,620	134	914	1.20	1.65	1,891	389	1,253	1.60	2,007	-1,227											
B	45.0	22.4	1.75	3.05	1.30	0.74	0.20	2.86	963	119	266	0.33	2.73	1,524	214	433	814	0.65	2.40	2,701	512	814	0.98	2.07	3,646	892	1,144	1.30	4,475	-1,396											
A	45.0	22.4	2.50	3.50	1.00	0.40	0.15	3.35	1,695	224	234	0.25	3.25	2,773	383	384	737	0.75	2.75	7,716	815	737	0.75	2.75	7,716	1,296	1,059	1.00	10,037	-1,534											
	50.0	18.4	1.50	3.15	1.65	1.10	0.25	2.90	761	42	229	0.41	2.74	1,166	93	370	684	0.83	2.33	1,890	294	684	1.24	1.91	2,319	605	942	1.65	2,600	-1,104											
	50.0	18.4	2.00	3.65	1.65	0.83	0.25	3.40	1,419	137	263	0.41	3.24	2,229	251	428	800	0.83	2.83	3,868	610	800	1.24	2.41	5,114	1,079	1,116	1.65	6,163	-1,471											
	50.0	18.4	2.50	4.15	1.65	0.66	0.25	3.90	2,424	232	298	0.41	3.74	3,870	409	486	916	0.83	3.33	7,002	926	916	1.24	2.91	9,643	1,552	1,291	1.65	12,038	-1,839											
	50.0	20.4	2.00	3.50	1.50	0.75	0.23	3.28	1,243	136	244	0.38	3.13	1,966	244	397	745	0.75	2.75	3,478	578	745	1.13	2.38	4,687	1,000	1,045	1.50	5,745	-1,371											
	50.0	20.4	2.50	3.85	1.35	0.54	0.20	3.65	1,862	215	240	0.34	3.51	3,008	373	393	746	0.68	3.18	5,601	817	746	1.01	2.84	7,919	1,334	1,060	1.35	10,098	-1,543											
	50.0	22.4	2.00	3.60	1.60	0.80	0.24	3.36	1,427	125	286	0.40	3.20	2,247	228	466	872	0.80	2.80	3,924	566	872	1.20	2.40	5,222	985	1,220	1.60	6,329	-1,511											
	50.0	22.4	2.50	3.90	1.40	0.56	0.21	3.69	2,023	209	270	0.35	3.55	3,261	364	442	806	0.70	3.20	6,044	806	838	1.05	2.85	8,510	1,324	1,190	1.40	10,817	-1,653											
C	50.0	25.4	1.25	2.85	1.60	1.28	0.24	2.61	565	-11	254	0.40	2.45	854	2	410	755	0.80	2.05	1,328	106	755	1.20	1.65	1,550	312	1,035	1.60	1,646	-1,006											
	50.0	25.4	1.50	3.10	1.60	1.07	0.24	2.86	808	32	276	0.40	2.70	1,242	74	447	828	0.80	2.30	2,028	250	828	1.20	1.90	2,512	528	1,145	1.60	2,844	-1,207											
B	50.0	25.4	2.00	3.40	1.40	0.70	0.21	3.19	1,226	128	264	0.35	3.05	1,949	230	430	810	0.70	2.70	3,491	537	810	1.05	2.35	4,762	923	1,140	1.40	5,898	-1,408											
	50.0	25.4	2.25	3.75	1.50	0.67	0.23	3.53	1,821	165	312	0.38	3.38	2,905	292	508	959	0.75	3.00	5,249	675	959	1.13	2.63	7,217	1,147	1,353	1.50	8,997	-1,697											
	50.0	25.4	2.50	3.90	1.40	0.56	0.21	3.69	2,154	204	302	0.35	3.55	3,473	355	494	897	0.55	3.55	8,214	897	897	0.83	3.27	11,976	1,418	1,135	1.40	11,519	-1,760											
A	50.0	25.4	3.00	4.10	1.10	0.37	0.17	3.94	2,594	249	249	0.28	3.83	4,255	424	409	787	0.55	3.55	8,214	897	787	0.83	3.27	11,976	1,418	1,135	1.40	11,519	-1,760											
C	56.0	28.5	1.50	3.45	1.95	1.30	0.29	3.16	966	-17	299	0.49	2.96	1,458	-4	483	889	0.98	2.48	2,259	112	889	1.46	1.99	2,622	350	1,218	1.95	2,766	-1,174											
B	56.0	28.5	2.00	3.60	1.60	0.80	0.24	3.36	1,213	94	255	0.40	3.20	1,910	173	415	778	0.80	2.80	3,335	428	778	1.20	2.40	4,438	765	1,090	1.60	5,379	-1,284											
A	56.0	28.5	3.00	4.30	1.30	0.43	0.20	4.11	2,539	216	247	0.33	3.98	4,142	371	404	775	0.65	3.65	7,895	795	775	0.98	3.32	11,388	1,274	1,110	1.30	14,762	-1,565											
	60.0	20.5	2.00	4.20	2.20	1.10	0.33	3.87	1,650	58	272	0.55	3.65	2,528	125	440	866	1.10	3.10	4,097	386	866	1.65	2.55	5,026	784	1,119	2.20	5,636	-1,346											
	60.0	20.5	2.50	4.70	2.20	0.88	0.33	4.37	2,657	149	303	0.55	4.15	4,151	276	491	1,110	1.10	3.60	7,102	688	1,110	1.65	3.05	9,255	1,237	1,273	2.20	11,008	-1,682											
	60.0	25.5	2.50	4.40	1.90	0.76	0.29	4.12	2,181	143	277	0.48	3.93	3,447	259	451	847	0.95	3.45	6,081	616	847	1.43	2.98	8,175	1,072	1,187	1.90	9,997	-1,527											
	60.0	25.5	3.00	4.65	1.65	0.55	0.25	4.40	2,786	213	254	0.41	4.24	4,495	369	414	787	0.83	3.83	8,352	812	787	1.24	3.41	11,784	1,330	1,117	1.65	15,002	-1,592											
	60.0	30.5	2.50	4.50	2.00	0.80	0.30	4.20	2,578	128	347	0.50	4.00	4,059	236	564	1,058	1.00	3.50	7,088	583	1,058	1.50	3.00	9,432	1,041	1,481	2.00	11,433	-1,747											
	60.0	30.5	3.00	4.70	1.70	0.57	0.26	4.45	3,155	204	307	0.43	4.28	5,083	356	502	953	0.85	3.85	9,407	793	953	1.28	3.43	13,226	1,309	1,353	1.70	16,792	-1,782											
	60.0	30.5	3.50	5.00	1.50	0.43	0.23	4.78	4,039	255	288	0.38	4.63	6,591	437	472	905	0.75	4.25	12,574	937	905	1.13	3.88	18,153	1,499	1,297	1.50	23,528	-1,834											
C	63.0	31.0	1.80	4.15	2.35	1.31	0.35	3.80	1,566	-19	332	0.59	3.56	2,364	-4	536	986	1.18	2.98	3,658	130	986	1.76	2.39	4,238	402	1,351	2.35	4,463	-1,315											
B	63.0	31.0	2.50	4.25	1.75	0.70	0.26	3.99	1,850	127	252	0.44	3.81	2,942	227	410	773	0.88	3.38	5,270	531	773	1.31	2.94	7,189	912	1,088	1.75	8,904	-1,360											
	63.0	31.0	3.00	4.70	1.70	0.57	0.26	4.45	2,808	186	270	0.43	4.28	4,524	324	441	838	0.85	3.85	8,373	721	838	1.28	3.43	11,772	1,190	1,189	1.70	14,946	-1,586											
A	63.0	31.0	3.50	4.90	1.40	0.40	0.21	4.69	3,301	224	241	0.40	4.55	5,399	383	380	729	0.70	4.20	10,359	815	729	1.05	3.85	15,025	1,296	1,047	1.40	19,545	-1,524											
	70.0	30.5	2.50	4.90	2.40	0.96	0.36	4.54	2,421	78	293	0.60	4.30	3,755	153	475	883	1.80	3.10	8,031	422	883	1.80	3.10	8,031	806	1,225	2.40	9,360	-1,430											

DISC SPRINGS TO DIN EN 16983 (formerly DIN 2093)

DIN Series	Dimensions											Design Force, Deflection and Stresses Based on $E = 206 \text{ kMPa}$ and $\mu = 0.3$																					
	D_e	D_i	t	l_0	h_0	h_0/t	Preload, $s = 0.15 h_0$						$s = 0.25 h_0$						$s = 0.5 h_0$						$F_t @ l_0 - 0.75 h_0$						$s = h_0$		
							s	l_t	F	σ_{th}	σ_{tm}	s	l_t	F	σ_{th}	σ_{tm}	s	l_t	F	σ_{th}	σ_{tm}	s	l_t	F	σ_{th}	σ_{tm}	s	l_t	F	σ_{th}	σ_{tm}	s	F
	70.0	30.5	3.00	5.10	2.10	0.70	0.32	4.79	2.941	155	266	0.53	4.58	4.676	276	433	814	1.05	4.05	8.376	640	814	1.58	3.53	11.426	1.093	1.145	2.10	14.152	-1.502			
	70.0	35.5	3.00	5.10	2.10	0.70	0.32	4.79	3.162	147	302	0.53	4.58	5.028	264	493	928	1.05	4.05	9.007	617	928	1.58	3.53	12.287	1.060	1.307	2.10	15.218	-1.615			
	70.0	35.5	4.00	5.80	1.80	0.45	0.27	5.53	5.376	250	294	0.45	5.35	8.757	430	482	921	0.90	4.90	16.634	925	921	1.35	4.45	23.923	1.486	1.319	1.80	30.919	-1.845			
C	71.0	36.0	2.00	4.60	2.60	1.30	0.39	4.21	1.895	-19	330	0.65	3.95	2.861	-5	532	125	1.30	3.30	4.432	125	980	1.95	2.65	5.144	388	1.342	2.60	5.426	-1.295			
B	71.0	36.0	2.50	4.50	2.00	0.80	0.30	4.20	1.838	92	247	0.50	4.00	2.894	169	402	754	1.50	3.00	6.725	417	754	1.50	3.00	6.725	744	1.055	2.00	8.152	-1.246			
A	71.0	36.0	4.00	5.60	1.60	0.40	0.24	5.36	4.511	230	245	0.40	5.20	7.379	393	402	837	0.80	4.80	14.157	837	772	1.20	4.40	20.535	1.332	1.109	1.60	26.712	-1.594			
C	80.0	41.0	2.25	5.20	2.95	1.31	0.44	4.76	2.452	-22	337	0.74	4.46	3.698	-9	544	117	1.48	3.73	5.715	117	1,000	2.21	2.99	6.613	379	1,370	2.95	6.950	-1,311			
B	80.0	41.0	3.00	5.30	2.30	0.77	0.35	4.96	2.817	107	267	0.58	4.73	4.450	196	434	814	1.15	4.15	7.838	474	814	1.73	3.57	10.518	835	1,142	2.30	12.844	-1,363			
	80.0	41.0	4.00	6.20	2.20	0.55	0.33	5.87	5.407	203	298	0.55	5.65	8.726	354	486	924	1.10	5.10	16.213	783	924	1.65	4.55	22.874	1,288	1,314	2.20	29.122	-1,738			
A	80.0	41.0	5.00	6.70	1.70	0.34	0.26	6.45	7.192	258	248	0.43	6.28	11.821	439	407	786	0.85	5.85	22.928	924	786	1.28	5.42	33.559	1,453	1,135	1.70	43.952	-1,679			
C	90.0	46.0	2.50	5.70	3.20	1.28	0.48	5.22	2.800	-14	315	0.80	4.90	4.232	2	509	130	1.60	4.10	6.585	130	938	2.40	3.30	7.684	385	1,286	3.20	8.157	-1,246			
B	90.0	46.0	3.50	6.00	2.50	0.71	0.38	5.63	3.675	120	258	0.63	5.38	5.836	216	421	509	1.25	4.75	10.416	509	792	1.88	4.12	14.161	879	1,114	2.50	17.487	-1,363			
A	90.0	46.0	5.00	7.00	2.00	0.40	0.30	6.70	6.888	223	240	0.50	6.00	11.267	382	394	814	1.00	6.00	21.617	814	757	1.50	5.50	31.354	1,295	1,088	2.00	40.786	-1,586			
	100.0	41.0	4.00	7.20	3.20	0.80	0.48	6.72	5.535	131	269	0.80	6.40	8.714	238	437	814	1.60	5.60	15.219	577	818	2.40	4.80	20.251	1,017	1,144	3.20	24.547	-1,465			
	100.0	41.0	5.00	7.75	2.75	0.55	0.41	7.34	7.650	216	247	0.69	7.06	12.345	374	404	814	1.38	6.38	22.937	823	767	2.06	5.69	32.361	1,346	1,089	2.75	41.201	-1,574			
C	100.0	51.0	2.70	6.20	3.50	1.30	0.53	5.68	3.165	-17	303	0.88	5.33	4.779	-3	490	116	1.75	4.45	7.410	116	902	2.63	3.57	8.609	357	1,235	3.50	9.091	-1,191			
B	100.0	51.0	3.50	6.30	2.80	0.80	0.42	5.88	3.572	91	246	0.70	5.60	5.624	167	399	411	1.40	4.90	9.823	411	749	2.10	4.20	13.070	734	1,049	2.80	15.843	-1,235			
	100.0	51.0	4.00	7.00	3.00	0.75	0.45	6.55	5.482	124	292	0.75	6.25	8.673	225	476	540	1.50	5.50	15.341	540	894	2.25	4.75	20.674	944	1,255	3.00	25.338	-1,512			
	100.0	51.0	5.00	7.80	2.80	0.56	0.42	7.38	8.637	204	303	0.70	7.10	13.924	355	496	789	1.40	6.40	25.810	789	942	2.10	5.70	36.339	1,301	1,337	2.80	46.189	-1,764			
A	100.0	51.0	6.00	8.20	2.20	0.37	0.33	7.87	10.401	249	250	0.55	7.65	17.061	424	411	897	1.10	7.10	32.937	897	790	1.65	6.55	48.022	1,418	1,139	2.20	62.711	-1,663			
C	112.0	57.0	3.00	6.90	3.90	1.30	0.59	6.32	3.865	-17	299	0.98	5.93	5.834	-4	483	112	1.95	4.95	9.038	112	889	2.93	3.97	10.489	350	1,218	3.90	11.064	-1,174			
B	112.0	57.0	4.00	7.20	3.20	0.80	0.48	6.72	4.852	94	255	0.80	6.40	7.639	173	415	428	1.60	5.60	13.341	428	778	2.40	4.80	17.752	765	1,090	3.20	21.518	-1,284			
A	112.0	57.0	6.00	8.50	2.50	0.42	0.38	8.13	9.672	212	234	0.63	7.88	15.800	363	384	777	1.25	7.25	30.215	777	737	1.88	6.62	43.707	1,239	1,058	2.50	56.737	-1,505			
C	125.0	64.0	3.50	8.00	4.50	1.29	0.68	7.33	5.635	-16	323	1.13	6.88	8.514	0	522	129	2.25	5.75	13.231	129	961	3.38	4.62	15.416	388	1,318	4.50	16.335	-1,273			
B	125.0	64.0	5.00	8.50	3.50	0.70	0.53	7.98	7.697	128	266	0.88	7.63	12.238	229	433	537	1.75	6.75	21.924	537	816	2.63	5.87	29.908	923	1,149	3.50	37.041	-1,415			
C	140.0	72.0	3.80	8.70	4.90	1.29	0.74	7.97	6.299	-16	306	1.23	7.48	9.514	-2	495	119	2.45	6.25	14.773	119	911	3.68	5.02	17.195	362	1,249	4.90	18.199	-1,203			
B	140.0	72.0	5.00	9.00	4.00	0.80	0.60	8.40	7.631	94	258	1.00	8.00	12.014	173	419	428	2.00	7.00	20.982	428	787	3.00	6.00	27.920	764	1,101	4.00	33.843	-1,293			
C	160.0	82.0	4.30	9.90	5.60	1.30	0.84	9.06	8.058	-18	304	1.40	8.50	12.162	-6	491	111	2.80	7.10	18.832	111	904	4.20	5.70	21.843	350	1,238	5.60	23.022	-1,189			
B	160.0	82.0	6.00	10.50	4.50	0.75	0.68	9.83	10.873	109	258	1.13	9.38	17.203	197	420	474	2.25	8.25	30.431	474	790	3.38	7.12	41.008	830	1,109	4.50	50.260	-1,333			
C	180.0	92.0	4.80	11.00	6.20	1.29	0.93	10.07	9.698	-15	295	1.55	9.45	14.646	-2	476	115	3.10	7.90	22.731	115	877	4.65	6.35	26.442	350	1,201	6.20	27.966	-1,169			
B	180.0	92.0	6.00	11.10	5.10	0.85	0.77	10.34	10.568	77	244	1.28	9.83	16.558	144	396	742	2.55	8.55	28.552	368	742	3.83	7.27	37.502	672	1,035	5.10	44.930	-1,192			
C	200.0	102.0	5.50	12.50	7.00	1.27	1.05	11.45	13.104	-12	306	1.75	10.75	19.817	5	494	131	3.50	9.00	30.882	131	910	5.25	7.25	36.111	381	1,247	7.00	36.423	-1,213			

STAINLESS STEEL DISC SPRINGS

STANDARD MATERIAL	
D	Austenitic Stainless Steel
STANDARD FINISH	
K	Plain

TO ORDER: Product / D_e x D_i x D_o x t / material code / finish code
 EXAMPLE: DSC 25 x 12.2 x 0.9 DK

DIN Series	Dimensions											Design Force, Deflection and Stresses Based on E = 190 kMPa and μ = 0.3																	
	D _e	D _i	t	l _o	h _o	h _o /t	Preload, s = 0.15 h _o					s = 0.25 h _o					s = 0.5 h _o					F _t @ l _o - 0.75 h _o					s = h _o		
							s	l _t	F	σ _{ti}	σ _{th}	s	l _t	F	σ _{ti}	σ _{th}	s	l _t	F	σ _{ti}	σ _{th}	s	l _t	F	σ _{ti}	σ _{th}	s	l _t	F
A	8.0	4.2	0.40	0.60	0.20	0.50	0.03	0.57	45	183	247	0.05	0.55	72	317	405	0.10	0.50	136	691	772	0.15	0.45	193	1,124	1,102	0.20	248	-1,480
B	10.0	5.2	0.40	0.70	0.30	0.75	0.05	0.66	51	114	275	0.08	0.63	81	207	448	0.15	0.55	143	497	841	0.23	0.48	193	870	1,181	0.30	237	-1,412
A	10.0	5.2	0.50	0.75	0.25	0.50	0.04	0.71	69	183	245	0.06	0.69	112	317	401	0.13	0.63	211	691	764	0.19	0.56	300	1,123	1,090	0.25	385	-1,471
B	12.5	6.2	0.50	0.85	0.35	0.70	0.05	0.80	70	119	238	0.09	0.76	111	213	387	0.18	0.68	198	497	730	0.26	0.59	271	853	1,027	0.35	335	-1,281
A	12.5	6.2	0.70	1.00	0.30	0.43	0.05	0.96	135	217	239	0.08	0.93	221	372	392	0.15	0.85	421	797	750	0.23	0.78	608	1,275	1,076	0.30	789	-1,537
B	14.0	7.2	0.50	0.90	0.40	0.80	0.06	0.84	70	87	238	0.10	0.80	111	160	387	0.20	0.70	194	395	725	0.30	0.60	258	705	1,016	0.40	312	-1,192
A	14.0	7.2	0.80	1.10	0.30	0.38	0.05	1.06	160	211	217	0.08	1.03	262	360	356	0.15	0.95	505	762	686	0.23	0.88	735	1,206	988	0.30	959	-1,431
C	16.0	8.2	0.40	0.90	0.50	1.25	0.08	0.83	51	-6	228	0.13	0.78	77	9	368	0.25	0.65	121	108	678	0.38	0.53	142	297	930	0.50	153	-911
B	16.0	8.2	0.60	1.05	0.45	0.75	0.07	0.98	100	101	238	0.11	0.94	159	182	388	0.23	0.83	281	437	728	0.34	0.71	378	765	1,023	0.45	464	-1,230
A	16.0	8.2	0.90	1.25	0.35	0.39	0.05	1.20	204	208	220	0.09	1.16	334	356	360	0.18	1.08	643	756	693	0.26	0.99	934	1,200	996	0.35	1,217	-1,435
C	18.0	9.2	0.45	1.05	0.60	1.33	0.09	0.96	74	-20	251	0.15	0.90	111	-13	406	0.30	0.75	171	77	746	0.45	0.60	197	269	1,020	0.60	206	-970
B	18.0	9.2	0.70	1.20	0.50	0.71	0.08	1.13	136	111	238	0.13	1.08	215	199	388	0.25	0.95	384	469	730	0.38	0.32	522	811	1,028	0.50	645	-1,257
A	18.0	9.2	1.00	1.40	0.40	0.40	0.06	1.34	254	206	222	0.10	1.30	416	353	363	0.20	1.20	798	751	698	0.30	0.47	1,157	1,195	1,003	0.40	1,505	-1,437
C	20.0	10.2	0.50	1.15	0.65	1.30	0.10	1.05	86	-14	241	0.16	0.99	130	-4	389	0.33	0.83	202	90	716	0.49	0.66	234	281	981	0.65	247	-944
B	20.0	10.2	0.80	1.35	0.55	0.69	0.08	1.27	176	119	238	0.14	1.21	281	212	388	0.28	1.08	504	494	732	0.41	0.94	690	846	1,031	0.55	857	-1,279
A	20.0	10.2	1.10	1.55	0.45	0.41	0.07	1.48	309	204	223	0.11	1.44	506	350	366	0.23	1.33	968	746	702	0.34	1.21	1,403	1,190	1,008	0.45	1,823	-1,438
C	22.5	11.2	0.60	1.40	0.80	1.33	0.12	1.28	147	-21	279	0.20	1.20	222	-13	450	0.40	1.00	341	91	827	0.60	0.80	392	310	1,132	0.80	410	-1,086
B	22.5	11.2	0.80	1.45	0.65	0.81	0.10	1.35	180	86	234	0.16	1.29	283	158	380	0.33	1.13	492	392	712	0.49	0.96	653	703	995	0.65	789	-1,177
A	22.5	11.2	1.25	1.75	0.50	0.40	0.08	1.68	391	206	216	0.13	1.63	639	353	354	0.25	1.50	1,227	751	679	0.38	1.38	1,779	1,195	977	0.50	2,314	-1,414
C	25.0	12.2	0.70	1.60	0.90	1.29	0.14	1.47	202	-12	285	0.23	1.38	305	3	460	0.45	1.15	475	125	847	0.68	0.93	553	365	1,161	0.90	586	-1,142
B	25.0	12.2	0.90	1.60	0.70	0.78	0.11	1.50	214	92	221	0.18	1.43	338	167	359	0.35	1.25	594	406	674	0.53	1.08	795	716	944	0.70	969	-1,142
A	25.0	12.2	1.50	2.05	0.55	0.37	0.08	1.97	585	230	221	0.14	1.91	959	392	363	0.28	1.78	1,851	829	698	0.41	1.64	2,699	1,309	1,006	0.55	3,524	-1,496
C	28.0	14.2	0.80	1.80	1.00	1.25	0.15	1.65	265	-7	294	0.25	1.55	401	12	475	0.50	1.30	628	142	876	0.75	0.77	739	389	1,203	1.00	792	-1,182
B	28.0	14.2	1.00	1.80	0.80	0.80	0.12	1.68	279	87	235	0.20	1.60	439	160	382	0.40	1.40	767	395	715	0.60	1.20	1,021	706	1,001	0.80	1,238	-1,182
A	28.0	14.2	1.50	2.15	0.65	0.43	0.10	2.05	584	199	227	0.16	1.99	953	342	372	0.33	1.83	1,817	734	712	0.49	1.66	2,620	1,175	1,021	0.65	3,394	-1,441
C	31.5	16.3	0.80	1.85	1.05	1.31	0.16	1.69	235	-17	256	0.26	1.59	354	-8	413	0.53	1.33	548	86	761	0.79	0.87	634	284	1,042	1.05	666	-993
B	31.5	16.3	1.25	2.15	0.90	0.72	0.14	2.02	459	115	284	0.23	1.93	729	206	414	0.45	1.70	1,300	488	779	0.68	1.48	1,764	846	1,095	0.90	2,176	-1,330
C	35.5	18.3	0.90	2.05	1.15	1.28	0.17	1.88	279	-11	244	0.29	1.76	422	2	394	0.58	1.48	657	100	725	0.86	1.19	767	295	994	1.15	815	-961
B	35.5	18.3	1.25	2.25	1.00	0.80	0.15	2.10	428	84	232	0.25	2.00	674	155	377	0.50	1.75	1,177	383	707	0.75	1.50	1,567	685	990	1.00	1,899	-1,161
C	40.0	20.4	1.00	2.30	1.30	1.30	0.20	2.11	345	-14	241	0.33	1.98	521	-4	389	0.65	1.65	808	90	716	0.98	1.33	938	281	981	1.30	989	-944
B	40.0	20.4	1.50	2.65	1.15	0.77	0.17	2.48	648	99	245	0.29	2.36	1,023	181	398	0.58	2.08	1,802	437	747	0.86	1.79	2,418	770	1,048	1.15	2,953	-1,253
C	45.0	22.4	1.25	2.85	1.60	1.28	0.24	2.61	635	-12	284	0.40	2.45	961	4	458	0.80	2.05	1,495	123	843	1.20	1.65	1,744	359	1,156	1.60	1,851	-1,132
C	50.0	25.4	1.25	2.85	1.60	1.28	0.24	2.61	521	-10	234	0.40	2.45	787	2	378	0.80	2.05	1,225	98	697	1.20	1.65	1,430	288	955	1.60	1,518	-928
C	56.0	28.5	1.50	3.45	1.95	1.30	0.29	3.16	891	-16	276	0.49	2.96	1,345	-4	446	0.98	2.48	2,084	104	820	1.46	0.52	2,419	323	1,124	1.95	2,551	-1,083
C	63.0	31.0	1.80	4.15	2.35	1.31	0.35	3.80	1,445	-18	306	0.59	3.56	2,180	-4	494	1.18	2.98	3,373	120	910	1.76	2.39	3,909	370	1,246	2.35	4,116	-1,213
C	71.0	36.0	2.00	4.60	2.60	1.30	0.39	4.21	1,748	-17	304	0.65	3.95	2,639	-4	491	1.30	3.30	4,088	115	904	1.95	2.65	4,744	358	1,238	2.60	5,004	-1,195

Mechanical Braking System



Application:

Braking systems for off-highway equipment are commonly designed to be hydraulically actuated. In most cases, braking occurs when pressurized fluid compresses stationary friction Discs against plates that rotate with the drive shaft. The amount of friction between each set of plates controls the deceleration of the vehicle. Without an additional fail safe system, this design alone has limited reliability. If a hydraulic seal is compromised, or the hydraulic cylinder loses pressure for any reason, the brakes fail.

Solution:

The mechanical back-up design uses **SPIROL** Disc Springs. Under normal circumstances, the hydraulic system holds a constant pressure on Disc Springs stacked in series. If pressure fails to be maintained, the stack of Disc Springs decompresses to actuate the braking mechanism. A compression spring or wave spring is not capable of providing the force required (in the space available) to actuate the brakes. The reliability of this safety system is dependent on the consistent performance of Disc Springs. In this critical application, the Disc Spring's performance and level of predictability improves product quality and ensures overall safety.

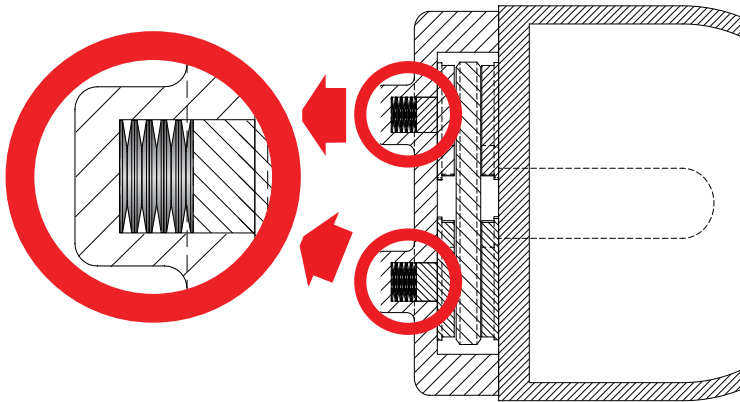

SPIROL Disc Springs have a consistently high capacity to store potential mechanical energy. The conical design of SPIROL Disc Springs makes their spring characteristics and performance more predictable than traditional compression springs. Disc Springs are also capable of providing more force in less space than a compression spring or wave spring. They are commonly stacked in multiples to achieve application specific spring rates: a stack in series provides less force over more travel; a stack in parallel provides more force over less travel. The precise tolerances of each individual Disc Spring provides unparalleled performance predictability when they are stacked (either in series or in parallel).

SPIROL Disc Springs also allow fatigue endurance to be predicted. Stress analysis enables the minimum cycle life of Disc Springs (singularly or stacked) to be calculated as a part of the application's design.

Pick-Off Unit for CNC Machines

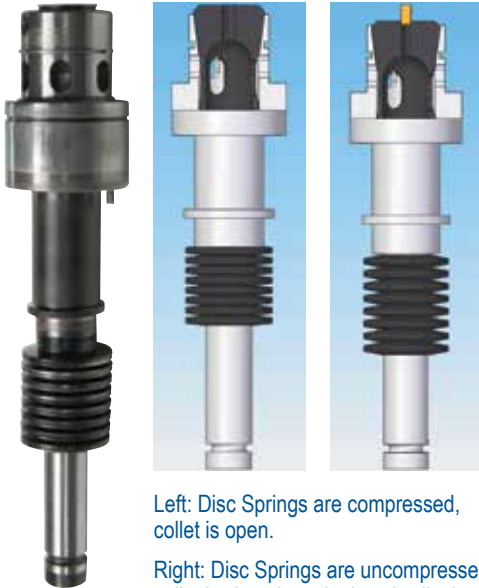

Left: Disc Springs are compressed, collet is open.

Right: Disc Springs are uncompressed, collet is closed, work piece is clinched.

Application:

Pick-off spindles in CNC screw machines are designed to hold a part as it is cut to length and then finished. The spindle uses a collet to release the part when it is complete and then clinch a new part.

When the machine is setup, the clamping force required to hold each part in the collet must be precisely calibrated to prevent the finished product from slipping (if the force is too low) or being crushed (if the force is too high). This calibration is dependent on the geometry and material of the final product. After calibration, the quality of the finished product relies on a consistent clamping force for thousands of cycles at a time.

Solution:

This high degree of reliability is provided by **SPIROL** Disc Springs. When the collet is opened, 16 SPIROL Disc Springs stacked in series are compressed by a hydraulic cylinder. Each time the force from the cylinder is released, SPIROL Disc Springs provide a consistent force to close the collet on the part.

Pipe Supports for Industrial Pipe Systems

Application:

As mandated by the ASME code for pressure piping, proper design and installation is critical for the performance and safety of piping systems. Industrial pipe systems are primarily supported by rod hangers, base line or base elbow supports. While these static supports are used to carry weight, dynamic supports are necessary to control loads on the pipe system.

Solution:

For example, in heat exchanger applications, SPIROL Disc Springs are used to accept thermal dynamics. As the temperature of the fluid within the pipe changes, the pipe will expand (when hot) and contract (when cold) accordingly. SPIROL Disc Springs support the system by maintaining a constant pressure at any temperature. This consistency is transmitted to the pipe joint and is essential for maintaining a proper seal. A well sealed gasket prevents fluids from escaping and reduces costly maintenance.

SPIROL Disc Springs offer an advantage to coil springs by providing an equivalent displacement in a fraction of the space. In many instances, such as under a heat exchanger's bottom flange, this space savings is required. SPIROL Disc Springs are the solution to providing a robust, maintenance free support system for industrial pipe systems.

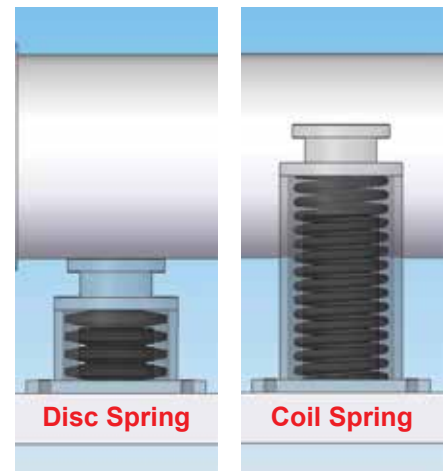
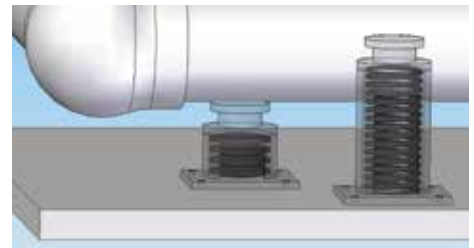

Disc Spring

Coil Spring

A coil spring cannot provide the proper support given the limited space in this example. Only a Disc Spring stack is able to package the required load and travel in the restricted space.



Please refer to www.SPIROL.com for current specifications and standard product offerings.

SPIROL Application Engineers will review your application needs and work with you to recommend the optimum solution. One way to start the process is to visit our **Optimal Application Engineering** portal at **SPIROL.com**.

Technical Centers

Americas **SPIROL International Corporation**
30 Rock Avenue
Danielson, Connecticut 06239 U.S.A.
Tel. +1 860 774 8571
Fax. +1 860 774 2048

SPIROL Shim Division
321 Remington Road
Stow, Ohio 44224 U.S.A.
Tel. +1 330 920 3655
Fax. +1 330 920 3659

SPIROL Canada
3103 St. Etienne Boulevard
Windsor, Ontario N8W 5B1 Canada
Tel. +1 519 974 3334
Fax. +1 519 974 6550

SPIROL Mexico
Avenida Avante #250
Parque Industrial Avante Apodaca
Apodaca, N.L. 66607 Mexico
Tel. +52 81 8385 4390
Fax. +52 81 8385 4391

SPIROL Brazil
Rua Mafalda Barnabé Soliane, 134
Comercial Vitória Martini, Distrito Industrial
CEP 13347-610, Indaiatuba, SP, Brazil
Tel. +55 19 3936 2701
Fax. +55 19 3936 7121

Europe **SPIROL France**
Cité de l'Automobile ZAC Croix Blandin
18 Rue Léna Bernstein
51100 Reims, France
Tel. +33 3 26 36 31 42
Fax. +33 3 26 09 19 76

SPIROL United Kingdom
17 Princewood Road
Corby, Northants
NN17 4ET United Kingdom
Tel. +44 1536 444800
Fax. +44 1536 203415

SPIROL Germany
Ottostr. 4
80333 Munich, Germany
Tel. +49 89 4 111 905 71
Fax. +49 89 4 111 905 72

SPIROL Spain
08940 Cornellà de Llobregat
Barcelona, Spain
Tel. +34 93 669 31 78
Fax. +34 93 193 25 43

SPIROL Czech Republic
Sokola Tůmy 743/16
Ostrava-Mariánské Hory 70900
Czech Republic
Tel/Fax. +420 417 537 979

SPIROL Poland
ul. Solec 38 lok. 10
00-394, Warszawa, Poland
Tel. +48 510 039 345

Asia Pacific **SPIROL Asia Headquarters**
1st Floor, Building 22, Plot D9, District D
No. 122 HeDan Road
Wai Gao Qiao Free Trade Zone
Shanghai, China 200131
Tel. +86 21 5046 1451
Fax. +86 21 5046 1540

SPIROL Korea
160-5 Seokchon-Dong
Songpa-gu, Seoul, 138-844, Korea
Tel. +86 (0) 21 5046-1451
Fax. +86 (0) 21 5046-1540

e-mail: info@spirol.com