

SUHNER[®]

TOOLholder

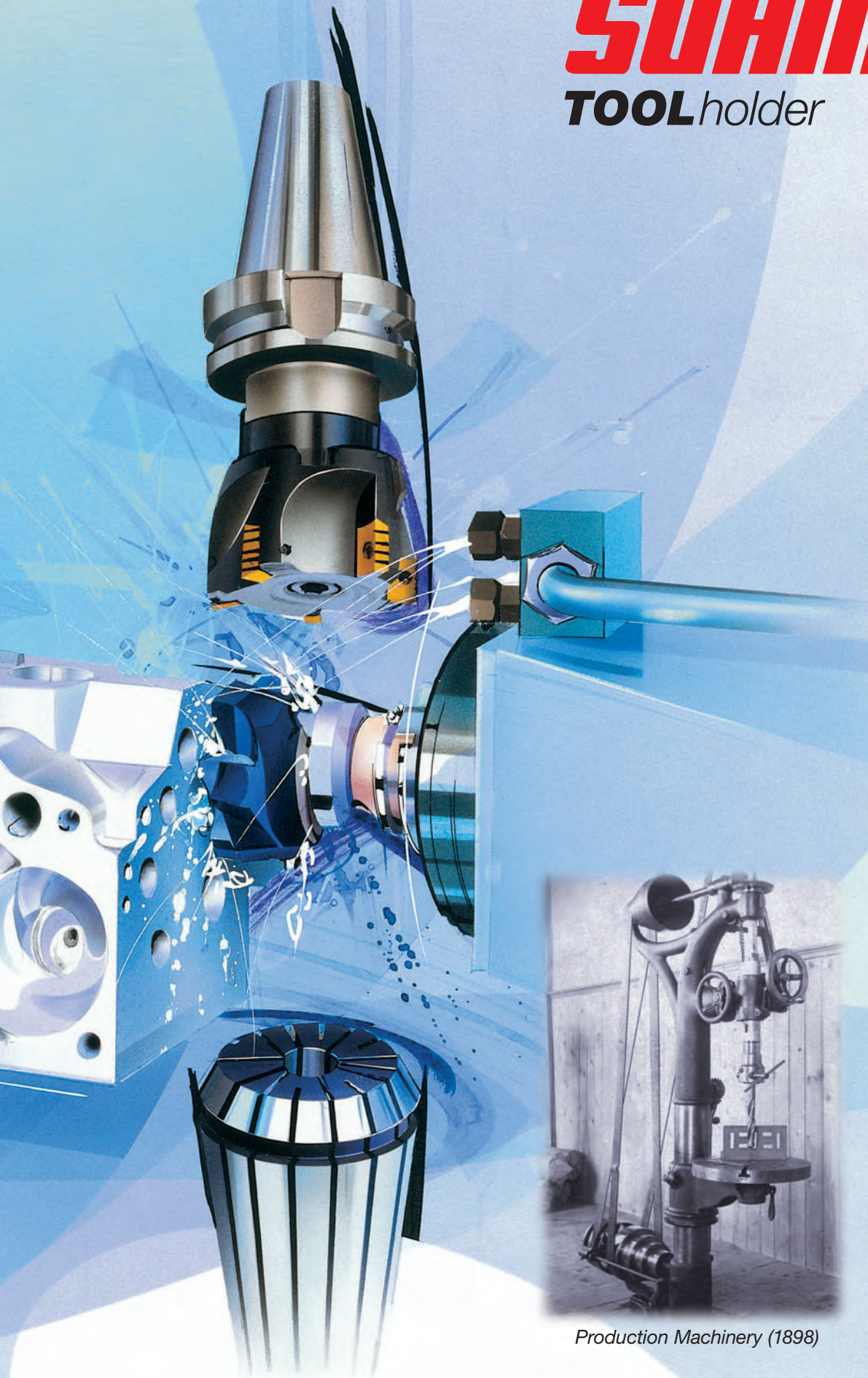

Production Machinery (1898)



Das TOOLholder-Programm nach SUHNER-Erfahrungen

Die richtige Auswahl von den Bearbeitungseinheiten angepassten Werkzeugspannelementen ist sehr wichtig, um optimale spanabhebende Bearbeitungsoperationen zu realisieren und eine lange Standzeit der Schneidwerkzeuge zu erhalten.

In diesem Bereich besitzt SUHNER einmalige Erfahrungen, da sie sowohl Bearbeitungseinheiten als auch Werkzeugmaschinen konzipiert und herstellt.

Dies erlaubt SUHNER, ein umfassendes Sortiment an Werkzeughaltern und Zubehörteilen anzubieten, die bestens zu den in diesem Katalog aufgeführten Bearbeitungseinheiten passen.

Lassen Sie sich von uns beraten.

The TOOLholder program based on SUHNER experiences

Proper selection of toolholders and machining units is very important to help obtain best machining results and to extend cutting tool life.

SUHNER has the experience in application engineering in complete machine tool design and build as well as in the manufacturing of machining units and spindles.

The SUHNER toolholder program with accessories is wide and comprehensive which always allows for an ideal combination of toolholders with respective machining units as illustrated in this catalog.

Le TOOLholder programme selon SUHNER

Afin que les opérations d'usinage par enlèvements de copeaux soient exécutées dans les meilleures conditions de précision et de durabilité des outils de coupe, le choix du porte-outil est très important, car il doit également correspondre parfaitement à l'unité d'usinage qui est mise en œuvre.

Dans ce domaine SUHNER a acquis une inestimable expérience, puisqu'il est à la fois concepteur-constructeur d'unités d'usinage et également de machines-outils, ce qui lui a permis de sélectionner un impressionnant programme de porte-outils et accessoires, qui correspondent exactement à toutes les unités d'usinage figurant au présent catalogue.

N'hésitez pas à nous interroger.

- CNC-Universal-Bohrfutter, Typ WT, Seiten G 09, G 11 und G 13
- ▲ Universal CNC drill chuck type WT, pages G 09, G 11, and G 13
- Mandrin de perçage universel CNC, type WT, pages G 09, G 11 et G 13

Typ / Type	WT 1	WT 2	WT 3
Spannbereich Clamping range Plage de serrage	0,5–8 mm	1–13 mm	3–16 mm
Rundlaufabweichung max. Max. run-out TIR Faux-rond max.	0,03 mm	0,03 mm	0,03 mm
Haltekraft bei 15 Nm Clamping force at 15 Nm Force de serrage 15 Nm	30 Nm	40 Nm	45 Nm
Anzugsmoment max. Max. assembly torque Traction max.	10 Nm	20 Nm	20 Nm
Haltekraft bei 20 Nm Holding force at 20 Nm Force de serrage 20 Nm	—	80 Nm	90 Nm
min ⁻¹ bis RPM up to t.min ⁻¹ jusqu'à	35 000 min	35 000 min	35 000 min

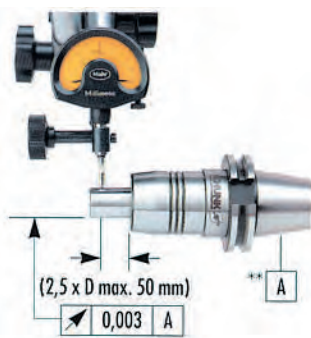
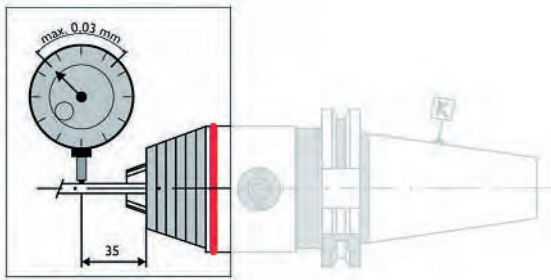

- Dehnspannfutter
Seiten G 11, G 12
und G 14

Hohe Rundlaufgenauigkeit

Höchste Dauerrundlauf- und Wiederholgenauigkeit von $\leq 3 \mu\text{m}$. Dadurch gleichmässiger Schneideneingriff der Werkzeuge und geringerer Verschleiss. Mehr als 4-fache Standzeitverbesserungen sind keine Seltenheit. Ihr Kostenvorteil, der sich leicht nachrechnen lässt.

- ▲ Expansion chucks
Page G 11, G 12,
and G 14

Highest TIR

Highest TIR accuracy and repeatability of $\leq 3 \mu\text{m}$. The result is a precise interference between tool cutting edge and workpiece rendering less tool wear. A quadrupling of the tool life can be a common result that would drastically increase your cost savings.

- Mandrins expansibles
Pages G 11, G 12
et G 14

Précision maximum

Précision maximum en concentricité permanente et précision en répétabilité $\leq 3 \mu\text{m}$. Grâce à elles, les arêtes de l'outil attaquent toujours uniformément et s'usent du même coup moins. Il n'est pas rare, que les outils durent quatre fois plus longtemps.



Wartungsfrei

Ein vollkommen geschlossenes System. Kein Eindringen von Schmutz, Kühl-/Schmierstoffen oder Spänen möglich. Wartungsfrei. Hohe Lebensdauer. 1 Jahr Garantie!

Maintenance-free

A completely enclosed system. No penetration of oil, grease, coolant, or chips is possible. Maintenance-free. High life expectancy. 1 year guarantee.

Mandrins exempts d'entretien

Système entièrement fermé. Les copeaux, le liquide d'arrosage et de lubrification ne peuvent pas pénétrer. Mandrins exempts d'entretien. Grande longévité et une année de garantie.

- Spannzangen W 1502, S 7–10, ER 8–ER 50, DIN 6499
- ▲ Collets W 1502, S 7–10, ER 8–ER 50, DIN 6499
- Pinces W 1502, S 7–10, ER 8–ER 50, DIN 6499

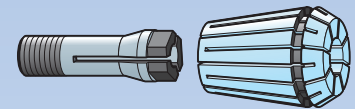

Seite / Page: **G 02**

- Gewindebohrzangen, ohne und mit Längenausgleich
- ▲ Tapping collets, with and without compensation
- Pinces pour tarauds, sans et avec compensation

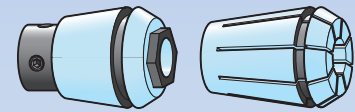

Seite / Page: **G 04**

- Werkzeugspannelemente mit Spannzangen ER 8–ER 50
- ▲ Toolholder systems, with collets ER 8–ER 50
- Porte-outils avec des pinces ER 8–ER 50



Seite / Page: **G 05**

- Aufsetzbare Schnellwechsel-Bohrfutter, DIN 55058
- ▲ Over spindle quick-change drilling chucks, DIN 55058
- Douilles DIN 55058 à changement rapide

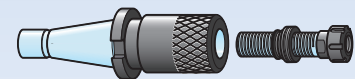

Seite / Page: **G 07**

- Schnellwechseleinsätze WE und Futter
- ▲ Quick-change adapters WE and toolholders
- Adaptateurs à changement rapide WE et porte-outils

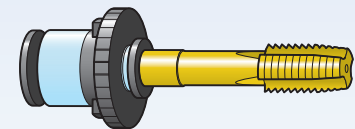

Seite / Page: **G 08**

- Steilkegel-Werkzeughalter SK 30 und SK 40, DIN 2080
- ▲ Taper toolholder cone S.A. 30 and S.A. 40, DIN 2080
- Mandrin avec attachement S.A. 30 et S.A. 40, DIN 2080



Seite / Page: **G 10**

- Hohlschaft-Werkzeughalter HSK 50, HSK 63, DIN 69893
- ▲ Hollow shaft toolholder HSK 50, HSK 63, DIN 69893
- Mandrin à cône-creux HSK 50, HSK 63, DIN 69893



Seite / Page: **G 12**

- Modulares Werkzeugsystem ABS 50, HSK 63
- ▲ Modular tooling system ABS 50, HSK 63
- Système de porte-outils modulaire ABS 50, HSK 63



Seite / Page: **G 14**

- Werkzeugspannsysteme für Mehrspindelköpfe
- ▲ Toolholder systems for multiple-spindle heads
- Système porte-outils pour têtes multibroches

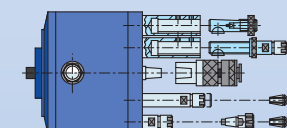

Seite / Page: **G 16**



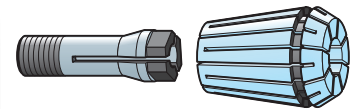

∅ 0,5–∅ 34

- **Spannzangen**
ER DIN 6499
- ▲ **Collets**
ER DIN 6499
- **Pinces**
ER DIN 6499

W 1502 / ER 8–50



● Typ
▲ Type
■ Type

W 1502

∅ mm	● Best.-Nr. ▲ Order No. ■ N° de cde.	∅ mm	● Best.-Nr. ▲ Order No. ■ N° de cde.
0,5	140 212 00	2,1	140 219 21
0,6	140 213 00	2,2	140 219 22
0,7	140 214 00	2,3	140 218 23
0,8	140 215 00	2,4	140 219 24
0,9	140 216 00	2,5	140 220 00
1,0	140 217 00	2,6	140 220 26
1,1	140 217 11	2,7	140 220 27
1,2	140 217 12	2,8	140 220 28
1,3	140 217 13	2,9	140 220 29
1,4	140 217 14	3,0	140 221 00
1,5	140 218 00	3,1	140 221 31
1,6	140 218 16	3,2	140 221 32
1,7	140 218 17	3,3	140 221 33
1,8	140 219 18	3,4	140 221 34
1,9	140 218 19	3,5	140 221 35
2,0	140 219 00	—	—

● Geeignet für:
▲ Used with:
■ Se monte sur:

W 1502	MH / 2
ER 8	MH / 5
ER 11	MH / 7
ER 20	MH / 13
S 7–10	PBW 4
ER 11	BEM 3
ER 11	BEW 3

G02



● Typ
▲ Type
■ Type

ER 8

∅ mm	● Best.-Nr. ▲ Order No. ■ N° de cde.
1,0–0,5	140 222
1,5–1,0	140 223
2,0–1,5	140 224
2,5–2,0	140 225
3,0–2,5	140 226
3,5–3,0	140 227
4,0–3,5	140 228
4,5–4,0	140 229
5,0–4,5	140 230
—	—
—	—
—	—
—	—
—	—
—	—

● Typ
▲ Type
■ Type

ER 11

∅ mm	● Best.-Nr. ▲ Order No. ■ N° de cde.
1,0–0,5	140 231
1,5–1,0	140 232
2,0–1,5	140 233
2,5–2,0	140 234
3,0–2,5	140 235
3,5–3,0	140 236
4,0–3,5	140 237
4,5–4,0	140 238
5,0–4,5	140 239
5,5–5,0	140 240
6,0–5,5	140 241
6,5–6,0	140 242
7,0–6,5	140 243
—	—
—	—

● Typ
▲ Type
■ Type

ER 20

∅ mm	● Best.-Nr. ▲ Order No. ■ N° de cde.
1,0– 0,5	140 247
1,5– 1,0	140 248
2,0– 1,5	140 249
2,5– 2,0	140 250
3,0– 2,5	140 251
4,0– 3,0	140 252
5,0– 4,0	140 253
6,0– 5,0	140 254
7,0– 6,0	140 255
8,0– 7,0	140 256
9,0– 8,0	140 257
10,0– 9,0	140 258
11,0–10,0	140 259
12,0–11,0	140 260
13,0–12,0	140 261

● Typ
▲ Type
■ Type

ER 40

∅ mm	● Best.-Nr. ▲ Order No. ■ N° de cde.	∅ mm	● Best.-Nr. ▲ Order No. ■ N° de cde.
4,0– 3,0	59 528 01	16,0–15,0	59 528 13
5,0– 4,0	59 528 02	17,0–16,0	59 528 14
6,0– 5,0	59 528 03	18,0–17,0	59 528 15
7,0– 6,0	59 528 04	19,0–18,0	59 528 16
8,0– 7,0	59 528 05	20,0–19,0	59 528 17
9,0– 8,0	59 528 06	21,0–20,0	59 528 18
10,0– 9,0	59 528 07	22,0–21,0	59 528 19
11,0–10,0	59 528 08	23,0–22,0	59 528 20
12,0–11,0	59 528 09	24,0–23,0	59 528 21
13,0–12,0	59 528 10	25,0–24,0	59 528 22
14,0–13,0	59 528 11	26,0–25,0	59 528 23
15,0–14,0	59 528 12	27,0–26,0	59 528 24

ER-GB

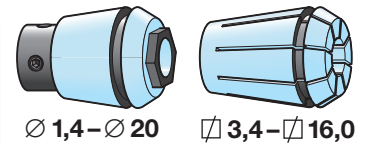
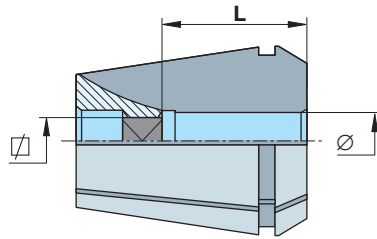

Ø 1,4 - Ø 20 ▨ 3,4 - ▨ 16,0

ER-ET

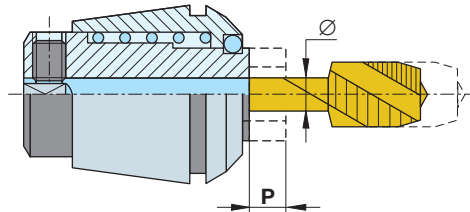

● **Gewindebohrzangen**
ER-GB ohne Längenausgleich
ER-ET mit Längenausgleich

▲ **Tapping collets**
ER-GB without compensation
ER-ET with compensation

■ **Pinces pour tarauds**
ER-GB sans compensation
ER-ET avec compensation

ER-GB / ER-ET

- Die Gewindebohrzangen werden gleich wie die Standard-ER-Spannzangen montiert.
- Der Typ **ER-GB** enthält einen Vierkant. Er ist ohne Längenausgleich ausgeführt. Dadurch kann er nur verwendet werden, wenn die Drehzahl genau mit dem Vorschub synchronisiert ist.
- Der Typ **ER-ET** ist mit einem axialen Längenausgleich ausgeführt.
- Auf Anfrage können wir die Ausführung in Inch-Abmessungen liefern.

- ▲ Tapping collets are used the same way as standard ER collets.
- Type **ER-GB** includes a square drive without length compensation. It can only be used in CNC applications with synchronized spindle speed and feed motion.
- Type **ER-ET** includes an axial length compensation.
- Tapping collets in inch dimensions are available upon request.

- Les pinces pour tarauds se montent de la même façon et à la place des pinces standard type ER.
- Le type **ER-GB** comporte un 4 pans (▨). Il est sans compensation, donc ne convient que si la vitesse de rotation est parfaitement synchronisée avec celle de l'avance.
- Le type **ER-ET** comporte une compensation axiale.
- Sur demande toutes exécutions aux côtes en inch.

Typ / Type		ER-GB 16			
Ø	▨	L	● Best.-Nr.	▲ Order No.	■ N° de cde.
mm	mm	mm			
4,5	3,4	18	59 530 01		
5,5	4,3	18	59 530 02		
6,0	4,9	18	59 530 03		
7,0	5,5	18	59 530 04		
—	—	—	—	—	—
—	—	—	—	—	—
—	—	—	—	—	—
—	—	—	—	—	—
—	—	—	—	—	—
—	—	—	—	—	—

Typ / Type		ER-GB 20			
Ø	▨	L	● Best.-Nr.	▲ Order No.	■ N° de cde.
mm	mm	mm			
4,5	3,4	18	59 530 11		
5,5	4,3	18	59 530 12		
6,0	4,9	18	59 530 13		
7,0	5,5	18	59 530 14		
8,0	6,2	22	59 530 15		
9,0	7,0	22	59 530 16		
10,0	8,0	25	59 530 17		
—	—	—	—	—	—
—	—	—	—	—	—
—	—	—	—	—	—
—	—	—	—	—	—

Typ / Type		ER-GB 25			
Ø	▨	L	● Best.-Nr.	▲ Order No.	■ N° de cde.
mm	mm	mm			
4,5	3,4	18	59 530 21		
5,5	4,3	18	59 530 22		
6,0	4,9	18	59 530 23		
7,0	5,5	18	59 530 24		
8,0	6,2	22	59 530 25		
9,0	7,0	22	59 530 26		
10,0	8,0	25	59 530 27		
11,0	9,0	25	59 530 28		
12,0	9,0	25	59 530 29		
—	—	—	—	—	—
—	—	—	—	—	—

Typ / Type		ER-GB 32			
Ø	▨	L	● Best.-Nr.	▲ Order No.	■ N° de cde.
mm	mm	mm			
4,5	3,4	18	59 530 41		
5,5	4,3	18	59 530 42		
6,0	4,9	18	59 530 43		
7,0	5,5	18	59 530 44		
8,0	6,2	22	59 530 45		
9,0	7,0	22	59 530 46		
10,0	8,0	25	59 530 47		
11,0	9,0	25	59 530 48		
12,0	9,0	25	59 530 49		
14,0	11,0	25	59 530 50		
16,0	12,0	25	59 530 51		
—	—	—	—	—	—

Typ / Type		ER-GB 40			
Ø	▨	L	● Best.-Nr.	▲ Order No.	■ N° de cde.
mm	mm	mm			
7,0	5,5	18	59 530 61		
8,0	6,2	22	59 530 62		
9,0	7,0	22	59 530 63		
10,0	8,0	25	59 530 64		
11,0	9,0	25	59 530 65		
12,0	9,0	25	59 530 66		
14,0	11,0	25	59 530 67		
16,0	12,0	25	59 530 68		
18,0	14,5	25	59 530 69		
20,0	16,0	28	59 530 70		
—	—	—	—	—	—

Typ / Type		ER-ET 12		
Ø	P	● Best.-Nr.	▲ Order No.	■ N° de cde.
mm	mm			
1,40	5,5	59 530 81		
1,60	5,5	59 530 82		
1,80	5,5	59 530 83		
2,00	5,5	59 530 84		
2,20	5,5	59 530 85		
2,50	5,5	59 530 86		
2,80	5,5	59 530 87		
3,00	5,5	59 530 88		
3,15	5,5	59 530 89		
3,50	5,5	59 530 90		
3,55	5,5	59 530 91		
—	—	—	—	—
—	—	—	—	—
—	—	—	—	—
—	—	—	—	—
—	—	—	—	—

Typ / Type		ER-ET 16		
Ø	P	● Best.-Nr.	▲ Order No.	■ N° de cde.
mm	mm			
1,40	7,0	59 531 01		
1,60	7,0	59 531 02		
1,80	7,0	59 531 03		
2,00	7,0	59 531 04		
2,20	7,0	59 531 05		
2,50	7,0	59 531 06		
2,80	7,0	59 531 07		
3,00	7,0	59 531 08		
3,15	7,0	59 531 09		
3,50	7,0	59 531 10		
3,55	7,0	59 531 11		
4,00	7,0	59 531 12		
4,50	7,0	59 531 13		
5,00	7,0	59 531 14		
5,50	7,0	59 531 15		
6,00	7,0	59 531 16		
6,20	7,0	59 531 17		
—	—	—	—	—
—	—	—	—	—

Typ / Type		ER-ET 20		
Ø	P	● Best.-Nr.	▲ Order No.	■ N° de cde.
mm	mm			
2,24	7,0	59 531 21		
2,50	7,0	59 531 22		
2,80	7,0	59 531 23		
3,00	7,0	59 531 24		
3,15	7,0	59 531 25		
3,50	7,0	59 531 26		
3,55	7,0	59 531 27		
4,00	7,0	59 531 28		
4,50	7,0	59 531 29		
5,00	7,0	59 531 30		
5,50	7,0	59 531 31		
6,00	7,0	59 531 32		
6,20	7,0	59 531 33		
6,30	7,0	59 531 34		
7,00	7,0	59 531 35		
—	—	—	—	—
—	—	—	—	—
—	—	—	—	—

Typ / Type		ER-ET 25		
Ø	P	● Best.-Nr.	▲ Order No.	■ N° de cde.
mm	mm			
2,50	10,0	59 531 41		
2,80	10,0	59 531 42		
3,00	10,0	59 531 43		
3,15	10,0	59 531 44		
3,50	10,0	59 531 45		
3,55	10,0	59 531 46		
4,00	10,0	59 531 47		
4,50	10,0	59 531 48		
5,00	10,0	59 531 49		
5,50	10,0	59 531 50		
6,00	10,0	59 531 51		
6,20	10,0	59 531 52		
6,30	10,0	59 531 53		
7,00	10,0	59 531 54		
7,10	10,0	59 531 55		
8,00	10,0	59 531 56		
8,50	10,0	59 531 57		
9,00	10,0	59 531 58		
10,00	10,0	59 531 59		
—	—	—	—	—

Typ / Type		ER-ET 32		
Ø	P	● Best.-Nr.	▲ Order No.	■ N° de cde.
mm	mm			
4,50	13,0	59 531 61		
5,00	13,0	59 531 62		
5,50	13,0	59 531 63		
6,00	13,0	59 531 64		
6,20	13,0	59 531 65		
6,30	13,0	59 531 66		
7,00	13,0	59 531 67		
7,10	13,0	59 531 68		
8,00	13,0	59 531 69		
8,50	13,0	59 531 70		
9,00	13,0	59 531 71		
10,00	13,0	59 531 72		
10,50	13,0	59 531 73		
11,00	13,0	59 531 74		
11,20	13,0	59 531 75		
12,00	13,0	59 531 76		
12,50	13,0	59 531 77		
—	—	—	—	—
—	—	—	—	—



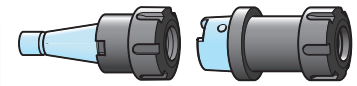

ER 16 – ER 32

- **Werkzeugspannelemente**
mit Spannzangen
- ▲ **Toolholder systems**
with collets
- **Porte-outils**
avec des pinces

ER 16 – ER 32



● Geeignet für: ▲ Used with: ■ Sa monte sur:	● Abmessungen für Aufbau ▲ Assembly dimensions ■ Cotations pour implantation	● Bezeichnung ▲ Description ■ Désignation	● Typ ▲ Type ■ Type	● Best.-Nr. ▲ Order No. ■ N° de cde.
BEM 6 BEM 6 D BEW 6		<ul style="list-style-type: none"> ● Schnellwechseleinsatz/Zangenspannung ER 16 ▲ Quick-change adapter for ER 16 collets ■ Adaptateur p. changem. rapide, serrage par pince ER 16 	SE 16/ER 16	50 649 02
		<ul style="list-style-type: none"> ● Spannmutter für Schnellwechseleinsatz SE 16/ER 16 ▲ Collet nut for quick-change toolholders SE 16/ER 16 ■ Ecrou de raccordement p. adaptateurs SE 16/ER 16 	SM/ER 16	50 649 01
BEM 12 BEM 12 D BEW 12		<ul style="list-style-type: none"> ● Schnellwechseleinsatz/Zangenspannung ER 25 ▲ Quick-change adapter for ER 25 collets ■ Adaptateur p. changem. rapide, serrage par pince ER 25 	SE 25/ER 25	50 648 02
		<ul style="list-style-type: none"> ● Spannmutter für Schnellwechseleinsatz SE 25/ER 25 ▲ Collet nut for quick-change toolholders SE 25/ER 25 ■ Ecrou de raccordement p. adaptateurs SE 25/ER 25 	SM/ER 25	50 648 01
BEM 12 BEX 15		<ul style="list-style-type: none"> ● Spannzangenhalter, zylindrisch ER 16 ▲ Straight collet toolholder ER 16 ■ Porte-pince cylindrique ER 16 	RF 16/ER 16	59 532 01
BEM 20 BEM 25 H BEA 25 CNC GEM 20 BEX 15 ISO		<ul style="list-style-type: none"> ● Spannfutter ISO 30 für Spannzange ER 32 ▲ Toolholder ISO 30 for collet ER 32 ■ Porte-outil ISO 30 avec serrage par pince ER 32 	ISO 30/ER 32	140 265
		<ul style="list-style-type: none"> ● Fließbohrfutter ISO 30 für Spannzange ER 25 ▲ Flow drill toolholder ISO 30 for collet ER 25 ■ Mandrin pour fluoperçage ISO 30 par pince ER 25 	ISO 30/FLI 30	58 659 01

G05



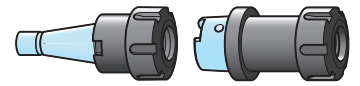

ER 16 – ER 32

● **Werkzeugspannelemente**
mit Spannzangen

▲ **Toolholder systems**
with collets

■ **Porte-outils**
avec des pinces

ER 32 – ER 50



<ul style="list-style-type: none"> ● Geeignet für: ▲ Used with: ■ Sa monte sur: 	<ul style="list-style-type: none"> ● Abmessungen für Aufbau ▲ Assembly dimensions ■ Cotations pour implantation 	<ul style="list-style-type: none"> ● Bezeichnung ▲ Description ■ Désignation 	<ul style="list-style-type: none"> ● Typ ▲ Type ■ Type 	<ul style="list-style-type: none"> ● Best.-Nr. ▲ Order No. ■ N° de cde.
BEM 28 BEX 35		<ul style="list-style-type: none"> ● Spannfutter ISO 40 für Spannzange ER 32 ▲ Toolholder ISO 40 for collet ER 32 ■ Porte-outil ISO 40 avec serrage par pince ER 32 	ISO 40/ER 32	59 541 02
BEM 20 BEM 25 H BEX 15		<ul style="list-style-type: none"> ● Spannfutter HSK-C 50 für Spannzange ER 32 ▲ Toolholder HSK-C 50 for collet ER 32 ■ Porte-outil HSK-C 50 avec serrage par pince ER 32 	HSK-C 50/ER 32	59 534 01
BEX 35		<ul style="list-style-type: none"> ● Spannfutter HSK-C 63 für Spannzange ER 40 ▲ Toolholder HSK-C 63 for collet ER 40 ■ Porte-outil HSK-C 63 avec serrage par pince ER 40 	HSK-C 63/ER 40	59 535 01
BEM 20 BEM 25 H BEX 15		<ul style="list-style-type: none"> ● Spannfutter ABS 50 für Spannzange ER 32 ▲ Toolholder ABS 50 for collet ER 32 ■ Porte-outil ABS 50 avec serrage par pince ER 32 	ABS 50/ER 32	59 536 01
BEX 35		<ul style="list-style-type: none"> ● Spannfutter ABS 63 für Spannzange ER 40 ▲ Toolholder ABS 63 for collet ER 40 ■ Porte-outil ABS 63 avec serrage par pince ER 40 	ABS 63/ER 40	59 537 01





TR 12 - TR 28

● **Aufsetzbare Schnellwechsel-Bohrfutter** für Bohr-, Reib- und Senkwerkzeuge

▲ **Over spindle quick-change drilling chucks** for drilling, chamfering and counterboring tools

■ **Douilles DIN à changement rapide d'outils**, porte-alésoir et porte-foret

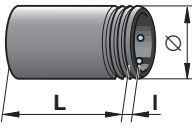
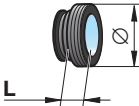
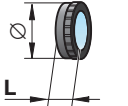
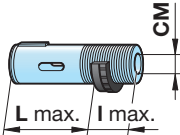
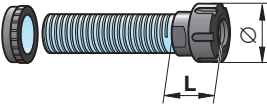
● Geeignet für: ▲ Used with: ■ Se monte sur:	● Typ ▲ Type ■ Type	● Best.-Nr. ▲ Order No. ■ N° de cde.	● Abmessungen für Aufbau ▲ Assembly dimensions ■ Cotations pour implantation	● Bezeichnung ▲ Description ■ Désignation
BEM 6 ST	ASBA 12 ASBA 16 ASBA 20 ASBA 25 ASBA 28	58 722 01 907 109 58 722 02 58 722 03 907 110	L=52 l=9 Ø24 L=67 l=10 Ø30 L=72 l=11 Ø38 L=79 l=12 Ø45 L=81 l=12 Ø48	 <p>● Schnellwechselfutter für Stellhülzenspindel DIN 55058 ▲ Quick-change spindle sleeve for automotive spindle type DIN 55058 ■ Douille pour changement rapide sur broche DIN 55058</p>
BEM 6 ST	SSM 12 SSM 16 SSM 20 SSM 25 SSM 28	58 723 01 907 112 58 723 02 58 723 03 907 114	L=9 Ø22 L=10 Ø26 L=11 Ø33 L=12 Ø40 L=12 Ø42	 <p>● Stellmutter auf Werkzeughalter für Schnellwechselfutter ▲ Depth adjustment nut for quick-change toolholders and sleeve ■ Ecrou de réglage sur porte-outil pour changement rapide</p>
BEM 6 ST	SM 12 SM 16 SM 20 SM 25 SM 28	58 724 01 907 113 58 724 02 58 724 03 907 115	L=12 Ø20 L=12 Ø25 L=12 Ø32 L=12 Ø37 L=12 Ø40	 <p>● Stellmutter auf Werkzeughalter für Stellhülzenspindel DIN 55058 ▲ Depth adjustment nut for automotive spindle toolholders type DIN 55058 ■ Ecrou de réglage sur porte-outil pour broche DIN 55058</p>
BEM 6 ST	D 12-6 D 16/0-MK 0 D 16/1-MK 1 D 20/1-MK 1 D 25/1-MK 1 D 25/2-MK 2 D 28/1-MK 1 D 28/2-MK 2	58 726 01 907 116 907 117 58 726 02 58 726 03 58 726 05 907 121 907 122	Metr. 6 L=53 l=25 MK 0 L=76 l=37 MK 1 L=76 l=37 MK 1 L=79 l=37 MK 1 L=85 l=38 MK 2 L=85 l=38 MK 1 L=85 l=38 MK 2 L=85 l=38	 <p>● Stellhülsen DIN 6327, CM 0 bis CM 2. Lange Ausführung auf Anfrage ▲ Automotive toolholder DIN 6327 with CM 0 up to CM 2. Extended length version upon request ■ Broche douille DIN 6327, CM 0 à CM 2. Version longue sur demande</p>
BEM 6 ST	SH 12/ER 11 SH 16/ER 16 SH 20/ER 20 SH 28/ER 25	58 725 01 907 120 58 725 02 907 125	L=35 Ø19 L=42 Ø28 L=48 Ø34 L=45 Ø42	 <p>● Werkzeughalter für Spannzangen ER 11 bis ER 25 ▲ Automotive toolholder for collets ER 11 up to ER 25 ■ Porte-outil pour pinces ER 11 à ER 25</p>



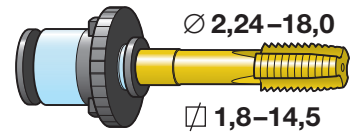

● Schnellwechseleinsätze und Futter zum Gewindeschneiden

▲ Quick-change adapters and toolholders for tapping

■ Adaptateurs à changement rapide et porte-outils pour le taraudage

WF 0-1 / WE 0-2

● Geeignet für: ▲ Used with: ■ Se monte sur:	● Gewindeschneid-Schnellwechselfutter ▲ Quick-change tapping adapter ■ Mandrin à changement rapide	● Typ ▲ Type ■ Type	WF 0	● Best.-Nr. ▲ Order No. ■ N° de cde.	907 252	● Schnellwechseleinsätze ▲ Quick-change tap insert ■ Porte-taraud à ch. rapide																																																																												
GEM 6 GEM 8						<table border="1"> <thead> <tr> <th colspan="3">Typ / Type</th> <th>WE 0</th> </tr> <tr> <th>\varnothing mm</th> <th>\varnothing mm</th> <th>● Best.-Nr. ▲ Order No. ■ N° de cde.</th> <th></th> </tr> </thead> <tbody> <tr><td>2,24</td><td>1,80</td><td>907 259</td><td></td></tr> <tr><td>2,50</td><td>2,10</td><td>907 253</td><td></td></tr> <tr><td>2,50</td><td>2,00</td><td>907 260</td><td></td></tr> <tr><td>2,80</td><td>2,24</td><td>907 261</td><td></td></tr> <tr><td>2,80</td><td>2,10</td><td>907 254</td><td></td></tr> <tr><td>3,50</td><td>2,70</td><td>907 255</td><td></td></tr> <tr><td>3,15</td><td>2,50</td><td>907 262</td><td></td></tr> <tr><td>3,55</td><td>2,80</td><td>907 263</td><td></td></tr> <tr><td>4,00</td><td>3,15</td><td>907 264</td><td></td></tr> <tr><td>4,00</td><td>3,00</td><td>907 256</td><td></td></tr> <tr><td>4,50</td><td>3,55</td><td>907 265</td><td></td></tr> <tr><td>4,50</td><td>3,40</td><td>907 257</td><td></td></tr> <tr><td>5,00</td><td>4,00</td><td>907 266</td><td></td></tr> <tr><td>5,60</td><td>4,50</td><td>907 267</td><td></td></tr> <tr><td>6,00</td><td>4,90</td><td>907 258</td><td></td></tr> <tr><td>6,30</td><td>5,00</td><td>907 268</td><td></td></tr> <tr><td>8,00</td><td>6,20</td><td>907 269</td><td></td></tr> </tbody> </table>	Typ / Type			WE 0	\varnothing mm	\varnothing mm	● Best.-Nr. ▲ Order No. ■ N° de cde.		2,24	1,80	907 259		2,50	2,10	907 253		2,50	2,00	907 260		2,80	2,24	907 261		2,80	2,10	907 254		3,50	2,70	907 255		3,15	2,50	907 262		3,55	2,80	907 263		4,00	3,15	907 264		4,00	3,00	907 256		4,50	3,55	907 265		4,50	3,40	907 257		5,00	4,00	907 266		5,60	4,50	907 267		6,00	4,90	907 258		6,30	5,00	907 268		8,00	6,20	907 269	
Typ / Type			WE 0																																																																															
\varnothing mm	\varnothing mm	● Best.-Nr. ▲ Order No. ■ N° de cde.																																																																																
2,24	1,80	907 259																																																																																
2,50	2,10	907 253																																																																																
2,50	2,00	907 260																																																																																
2,80	2,24	907 261																																																																																
2,80	2,10	907 254																																																																																
3,50	2,70	907 255																																																																																
3,15	2,50	907 262																																																																																
3,55	2,80	907 263																																																																																
4,00	3,15	907 264																																																																																
4,00	3,00	907 256																																																																																
4,50	3,55	907 265																																																																																
4,50	3,40	907 257																																																																																
5,00	4,00	907 266																																																																																
5,60	4,50	907 267																																																																																
6,00	4,90	907 258																																																																																
6,30	5,00	907 268																																																																																
8,00	6,20	907 269																																																																																

● Geeignet für: ▲ Used with: ■ Se monte sur:	● Gewindeschneid-Schnellwechselfutter ▲ Quick-change tapping adapter ■ Mandrin à changement rapide	● Typ ▲ Type ■ Type	WF 1	● Best.-Nr. ▲ Order No. ■ N° de cde.	906 749	● Schnellwechseleinsätze ▲ Quick-change tap insert ■ Porte-taraud à ch. rapide																																																																																
GEM 12						<table border="1"> <thead> <tr> <th colspan="3">Typ / Type</th> <th>WE 1</th> </tr> <tr> <th>\varnothing mm</th> <th>\varnothing mm</th> <th>● Best.-Nr. ▲ Order No. ■ N° de cde.</th> <th></th> </tr> </thead> <tbody> <tr><td>2,80</td><td>2,10</td><td>906 750</td><td></td></tr> <tr><td>3,15</td><td>2,50</td><td>906 762</td><td></td></tr> <tr><td>3,50</td><td>2,70</td><td>906 751</td><td></td></tr> <tr><td>4,00</td><td>3,15</td><td>906 763</td><td></td></tr> <tr><td>4,00</td><td>3,00</td><td>906 752</td><td></td></tr> <tr><td>4,50</td><td>3,40</td><td>906 753</td><td></td></tr> <tr><td>4,50</td><td>3,55</td><td>906 764</td><td></td></tr> <tr><td>6,00</td><td>4,90</td><td>906 754</td><td></td></tr> <tr><td>6,30</td><td>5,00</td><td>906 765</td><td></td></tr> <tr><td>7,00</td><td>5,50</td><td>906 755</td><td></td></tr> <tr><td>7,10</td><td>5,60</td><td>906 766</td><td></td></tr> <tr><td>8,00</td><td>6,20</td><td>906 756</td><td></td></tr> <tr><td>9,00</td><td>7,00</td><td>906 757</td><td></td></tr> <tr><td>9,00</td><td>7,10</td><td>906 767</td><td></td></tr> <tr><td>10,00</td><td>8,00</td><td>906 758</td><td></td></tr> <tr><td>11,00</td><td>9,00</td><td>906 759</td><td></td></tr> <tr><td>11,20</td><td>9,00</td><td>906 768</td><td></td></tr> <tr><td>12,00</td><td>9,00</td><td>906 760</td><td></td></tr> </tbody> </table>	Typ / Type			WE 1	\varnothing mm	\varnothing mm	● Best.-Nr. ▲ Order No. ■ N° de cde.		2,80	2,10	906 750		3,15	2,50	906 762		3,50	2,70	906 751		4,00	3,15	906 763		4,00	3,00	906 752		4,50	3,40	906 753		4,50	3,55	906 764		6,00	4,90	906 754		6,30	5,00	906 765		7,00	5,50	906 755		7,10	5,60	906 766		8,00	6,20	906 756		9,00	7,00	906 757		9,00	7,10	906 767		10,00	8,00	906 758		11,00	9,00	906 759		11,20	9,00	906 768		12,00	9,00	906 760	
Typ / Type			WE 1																																																																																			
\varnothing mm	\varnothing mm	● Best.-Nr. ▲ Order No. ■ N° de cde.																																																																																				
2,80	2,10	906 750																																																																																				
3,15	2,50	906 762																																																																																				
3,50	2,70	906 751																																																																																				
4,00	3,15	906 763																																																																																				
4,00	3,00	906 752																																																																																				
4,50	3,40	906 753																																																																																				
4,50	3,55	906 764																																																																																				
6,00	4,90	906 754																																																																																				
6,30	5,00	906 765																																																																																				
7,00	5,50	906 755																																																																																				
7,10	5,60	906 766																																																																																				
8,00	6,20	906 756																																																																																				
9,00	7,00	906 757																																																																																				
9,00	7,10	906 767																																																																																				
10,00	8,00	906 758																																																																																				
11,00	9,00	906 759																																																																																				
11,20	9,00	906 768																																																																																				
12,00	9,00	906 760																																																																																				



<ul style="list-style-type: none"> ● Geeignet für: ▲ Used with: ■ Se monte sur: 	<ul style="list-style-type: none"> ● Gewindeschneid-Schnellwechselfutter ▲ Quick-change tapping adapter ■ Mandrin à changement rapide 	<ul style="list-style-type: none"> ● Typ ▲ Type ■ Type 	ISO 30 POT 2	<ul style="list-style-type: none"> ● Best.-Nr. ▲ Order No. ■ N° de cde. 	<p style="text-align: right;">58 771 01</p>																																																										
						<ul style="list-style-type: none"> ● Schnellwechseleinsätze ▲ Quick-change tap insert ■ Porte-taraud à ch. rapide 																																																									
GEM 20						WE 2																																																									
						<table border="1" style="width: 100%; border-collapse: collapse;"> <thead> <tr> <th colspan="2">Typ / Type</th> <th>Best.-Nr.</th> </tr> <tr> <th>Ø mm</th> <th>□ mm</th> <th>Order No.</th> </tr> </thead> <tbody> <tr><td>6,0</td><td>4,9</td><td>907 128</td></tr> <tr><td>6,3</td><td>5,0</td><td>907 138</td></tr> <tr><td>7,0</td><td>5,5</td><td>907 129</td></tr> <tr><td>7,1</td><td>5,6</td><td>907 139</td></tr> <tr><td>8,0</td><td>6,3</td><td>907 140</td></tr> <tr><td>8,0</td><td>6,2</td><td>907 130</td></tr> <tr><td>9,0</td><td>7,0</td><td>907 131</td></tr> <tr><td>9,0</td><td>7,1</td><td>907 141</td></tr> <tr><td>10,0</td><td>8,0</td><td>907 132</td></tr> <tr><td>11,0</td><td>9,0</td><td>907 133</td></tr> <tr><td>11,2</td><td>9,0</td><td>907 143</td></tr> <tr><td>12,0</td><td>9,0</td><td>907 134</td></tr> <tr><td>12,5</td><td>10,0</td><td>907 144</td></tr> <tr><td>14,0</td><td>11,0</td><td>907 135</td></tr> <tr><td>14,0</td><td>11,2</td><td>907 145</td></tr> <tr><td>16,0</td><td>12,0</td><td>907 136</td></tr> <tr><td>18,0</td><td>14,5</td><td>907 137</td></tr> </tbody> </table>	Typ / Type		Best.-Nr.	Ø mm	□ mm	Order No.	6,0	4,9	907 128	6,3	5,0	907 138	7,0	5,5	907 129	7,1	5,6	907 139	8,0	6,3	907 140	8,0	6,2	907 130	9,0	7,0	907 131	9,0	7,1	907 141	10,0	8,0	907 132	11,0	9,0	907 133	11,2	9,0	907 143	12,0	9,0	907 134	12,5	10,0	907 144	14,0	11,0	907 135	14,0	11,2	907 145	16,0	12,0	907 136	18,0	14,5	907 137
Typ / Type		Best.-Nr.																																																													
Ø mm	□ mm	Order No.																																																													
6,0	4,9	907 128																																																													
6,3	5,0	907 138																																																													
7,0	5,5	907 129																																																													
7,1	5,6	907 139																																																													
8,0	6,3	907 140																																																													
8,0	6,2	907 130																																																													
9,0	7,0	907 131																																																													
9,0	7,1	907 141																																																													
10,0	8,0	907 132																																																													
11,0	9,0	907 133																																																													
11,2	9,0	907 143																																																													
12,0	9,0	907 134																																																													
12,5	10,0	907 144																																																													
14,0	11,0	907 135																																																													
14,0	11,2	907 145																																																													
16,0	12,0	907 136																																																													
18,0	14,5	907 137																																																													

- Alternative Spanntechniken für Gewindebohrer, geeignet für SUHNER-Gewindeschneideeinheiten
- ▲ Alternative toolholder systems for taps suitable for use with SUHNER tapping units
- Autre technique de serrage des tarauds, adaptée aux unités de taraudage SUHNER

<ul style="list-style-type: none"> ● Geeignet für: ▲ Used with: ■ Se monte sur: 	<ul style="list-style-type: none"> ● Abmessungen für Aufbau ▲ Assembly dimensions ■ Cotations pour implantation 	<ul style="list-style-type: none"> ● Bezeichnung ▲ Description ■ Désignation 	<ul style="list-style-type: none"> ● Typ ▲ Type ■ Type 	<ul style="list-style-type: none"> ● Best.-Nr. ▲ Order No. ■ N° de cde.
GEM 6 GEM 6 CN		<ul style="list-style-type: none"> ● Bohrfutter B 12, Spannbereich: Ø 0,5–8,0 mm. Haltekraft: max. 30 Nm, 5000 min⁻¹ ▲ Drill chuck B 12, clamping range 0.5–8.0 mm diameter. Clamping force maximum 30 Nm, 5000 RPM ■ Mandrin B 12, plage de serrage: Ø 0,5–8,0 mm. Force de serrage: 30 Nm, 5000 t.min⁻¹ 	WT 1	59 538 01
GEM 12		<ul style="list-style-type: none"> ● Bohrfutter B 16, Spannbereich: Ø 1,0–13,0 mm. Haltekraft: max. 80 Nm, 5000 min⁻¹ ▲ Drill chuck B 16, clamping range 1.0–13.0 mm diameter. Clamping force maximum 80 Nm, 5000 RPM ■ Mandrin B 16, plage de serrage: Ø 1,0–13,0 mm. Force de serrage: 80 Nm, 5000 t.min⁻¹ 	WT 2	59 538 02

G09



<ul style="list-style-type: none"> ● Adapter für Aufnahme in Bohrmaschine für die Gewindeschneidapparate GSX, Seiten D 60, D 61 ▲ Adapter for mounting in drilling machine for tapping attachment GSX, pages D 60 and D 61 ■ Adaptateur pour logement de perceuse pour appareils à tarauder GSX, pages D 60 et D 61 														
<ul style="list-style-type: none"> ● Aufnahme ▲ Adaption ■ Adaptation 	Morse				DIN 2080			MAS-BT		Zyl.				
	MK 1	MK 2	MK 3	MK 4	SK 30 M 12	SK 40 M 16	SK 50 M 24	BT 40 M 16	BT 50 M 24	Ø 8	Ø 10	Ø 12	Ø 16	Ø 20
3 Jt	903 910	903 911	903 912	903 913	—	904 741	904 742	906 628	906 630	—	—	—	—	—
33 Jt	903 906	903 907	903 908	903 909	—	903 930	906 626	906 627	906 629	8252 201	8252 202	8252 203	8252 204	8252 207
4 Jt	—	903 915	903 916	903 917	—	906 622	905 100	—	—	—	—	—	—	—
B-16	903 940	903 941	903 942	903 943	—	906 634	906 635	906 637	906 638	—	—	—	—	—
3/8"-24	906 605	906 606	906 607	—	—	—	—	—	—	—	—	—	—	—
1/2"-20	906 608	906 609	906 610	—	—	—	—	—	—	—	—	—	—	—
3/4"-16	—	906 611	906 612	—	—	—	—	906 640	906 641	—	—	—	—	—
1/2"-20	—	903 919	903 921	903 923	903 929	903 931	903 932	906 642	906 643	—	—	903 936	903 937	903 938

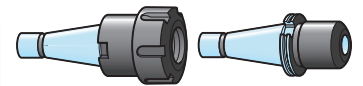

● Steilkegel-Werkzeughalter SK DIN 2080

▲ Taper toolholder, shank type S.A. DIN 2080

■ Mandrin à attachement S.A. DIN 2080

ISO 30 – ISO 40



● Geeignet für: ▲ Used with: ■ Se monte sur:	● Typ ▲ Type ■ Type	● Best.-Nr. ▲ Order No. ■ N° de cde.	● Abmessungen für Aufbau ▲ Assembly dimensions ■ Cotations pour implantation	● Bezeichnung ▲ Description ■ Désignation
BEM 20/BEX 15	ISO 30/MK 1	140 196	MK 1 L=50 Ø25	<p>● Einsatzhülsen SK/MK Kombi. DIN 6383 ▲ Morse taper adapters, combi. DIN 6383 ■ Douille de réduction ISO/CM. DIN 6383</p>
BEM 20/BEX 15	ISO 30/MK 2	140 197	MK 2 L=50 Ø32	
BEM 20/BEX 15	ISO 30/MK 3	140 198	MK 3 L=70 Ø40	
BEM 28/BEX 35	ISO 40/MK 1	140 199	MK 1 L=50 Ø25	
BEM 28/BEX 35	ISO 40/MK 2	140 200	MK 2 L=50 Ø32	<p>● Bohrfutteraufnahme B 16 ▲ Drill chuck adapter B 16 ■ Mandrin pour perceuse montage B 16</p>
BEM 28/BEX 35	ISO 40/MK 3	140 201	MK 3 L=65 Ø40	
BEM 28/BEX 35	ISO 40/MK 4	140 204	MK 4 L=95 Ø48	
BEM 20/BEX 15	ISO 30/B 16	58 657 01	B 16 L=35 I=20	
BEM 28/BEX 35	ISO 40/B 16	58 657 02	B 16 L=35 I=20	<p>● Weldon-Spannfutter DIN 6359 ▲ End mill adapter, Weldon DIN 6359 ■ Mandrin de serrage Weldon DIN 6359</p>
BEM 20/BEX 15	ISO 30/W 6	59 539 01	W 6 L=40 Ø25	
BEM 20/BEX 15	ISO 30/W 8	59 539 02	W 8 L=40 Ø28	
BEM 20/BEX 15	ISO 30/W 10	59 539 03	W 10 L=40 Ø35	
BEM 20/BEX 15	ISO 30/W 12	59 539 04	W 12 L=40 Ø42	
BEM 20/BEX 15	ISO 30/W 16	59 539 06	W 16 L=50 Ø48	
BEM 20/BEX 15	ISO 30/W 20	59 539 08	W 20 L=63 Ø52	
BEM 28/BEX 35	ISO 40/W 6	59 539 11	W 6 L=50 Ø25	
BEM 28/BEX 35	ISO 40/W 8	59 539 12	W 8 L=50 Ø28	
BEM 28/BEX 35	ISO 40/W 10	59 539 13	W 10 L=50 Ø35	
BEM 28/BEX 35	ISO 40/W 12	59 539 14	W 12 L=50 Ø42	
BEM 28/BEX 35	ISO 40/W 14	59 539 15	W 14 L=50 Ø44	
BEM 28/BEX 35	ISO 40/W 16	59 539 16	W 16 L=63 Ø48	
BEM 28/BEX 35	ISO 40/W 18	59 539 17	W 18 L=63 Ø50	
BEM 28/BEX 35	ISO 40/W 20	59 539 18	W 20 L=63 Ø52	
BEM 28/BEX 35	ISO 40/W 25	59 539 19	W 25 L=90 Ø65	
BEM 28/BEX 35	ISO 40/W 32	59 539 20	W 32 L=100 Ø72	
BEM 28/BEX 35	ISO 40/A 25	58 681 01	ABS 25 L=50 Ø13	<p>● ABS-Aufnahme für ABS-Schaft, Seite G 14 ▲ ABS adapters with ABS shank, page G 14 ■ Mandrin ABS pour montage queue ABS, page G 14</p>
BEM 28/BEX 35	ISO 40/A 32	58 681 02	ABS 32 L=50 Ø16	
BEM 28/BEX 35	ISO 40/A 40	58 681 03	ABS 40 L=50 Ø20	
BEM 28/BEX 35	ISO 40/A 50	58 681 04	ABS 50 L=50 Ø28	
BEM 28/BEX 35	ISO 40/A 63	58 681 05	ABS 63 L=70 Ø34	

G10

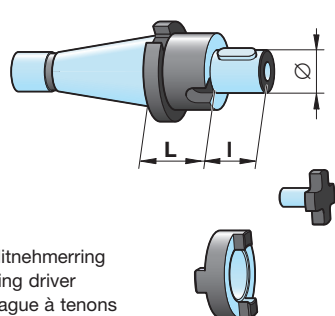
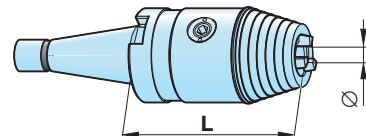
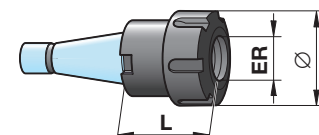
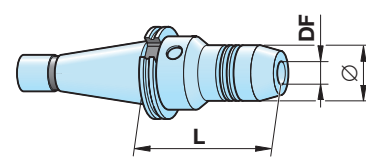
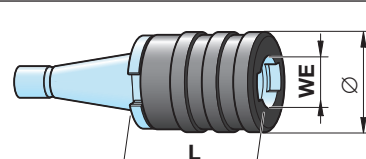
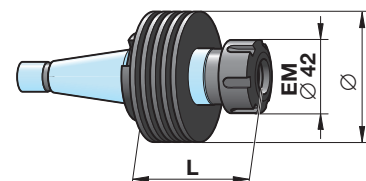
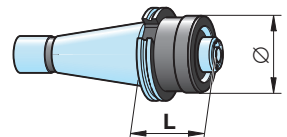

<ul style="list-style-type: none"> ● Geeignet für: ▲ Used with: ■ Se monte sur: 	<ul style="list-style-type: none"> ● Typ ▲ Type ■ Type 	<ul style="list-style-type: none"> ● Best.-Nr. ▲ Order No. ■ N° de cde. 	<ul style="list-style-type: none"> ● Abmessungen für Aufbau ▲ Assembly dimensions ■ Cotations pour implantation 			<ul style="list-style-type: none"> ● Bezeichnung ▲ Description ■ Désignation 	
BEM 20/BEX 15	ISO 30/FD 13	58 647 02	L=25	l=22	∅13	 <ul style="list-style-type: none"> ● Mitnehmerring ▲ Ring driver ■ Bague à tenons 	<ul style="list-style-type: none"> ● Kombi-Aufsteckfräsdorne DIN 6358 zur Aufnahme von Fräsern mit Längs- und Quernut ▲ Combination face mill adapter DIN 6358 for cutters with transversal slot or key drive ■ Mandrin à double usage DIN 6358 pour fraise avec rainures en long et transversal
BEM 20/BEX 15	ISO 30/FD 16	58 647 01	L=25	l=27	∅16		
BEM 20/BEX 15	ISO 30/FD 22	58 647 03	L=23	l=31	∅22		
BEM 28/BEX 35	ISO 40/FD 13	58 647 08	L=42	l=22	∅13		
BEM 28/BEX 35	ISO 40/FD 16	58 679 01	L=42	l=27	∅16		
BEM 28/BEX 35	ISO 40/FD 22	58 679 02	L=40	l=31	∅22		
BEM 28/BEX 35	ISO 40/FD 27	58 679 03	L=40	l=33	∅27		
BEM 28/BEX 35	ISO 40/FD 32	58 679 04	L=38	l=38	∅32		
BEM 28/BEX 35	ISO 40/FD 40	58 679 05	L=38	l=41	∅40		
BEX 35/BEX 45	ISO 40/WT 5	59 540 03	30 Nm	L=62	∅0,5-8		<ul style="list-style-type: none"> ● CNC-Universalbohrfutter bis 7000 min⁻¹ ▲ NC drill chucks up to 7000 RPM ■ Mandrin de perçage NC jusqu'à 7000 t.min⁻¹
BEX 35/BEX 45	ISO 40/WT 6	59 540 04	80 Nm	L=83	∅1-13		
BEX 35/BEX 45	ISO 40/WT 7	59 540 05	90 Nm	L=83	∅3-16		
BEM 20/BEX 15	ISO 30/ER 25	59 541 01	L=43	∅42	ER 25		<ul style="list-style-type: none"> ● Spannzangenhalter für ER-Spannzangen, Seite G 03 ▲ Toolholder for ER collet, page G 03 ■ Mandrin pour pince ER, page G 03
BEM 20/BEX 15	ISO 30/ER 32	140 265	L=50	∅50	ER 32		
BEM 28/BEX 35	ISO 40/ER 32	59 541 02	L=50	∅50	ER 32		
BEM 28/BEX 35	ISO 40/ER 40	59 541 03	L=55	∅63	ER 40		
BEM 20/BEX 15	ISO 30/DF 6	59 542 01	DF 6	L=72	∅26		<ul style="list-style-type: none"> ● Dehnspannfutter (Werkzeugtoleranz: h6) ▲ Expansion chuck (Tool tolerance: h6) ■ Mandrin expansible (tolérance h6 des outils)
BEM 20/BEX 15	ISO 30/DF 8	59 542 02	DF 8	L=72	∅28		
BEM 20/BEX 15	ISO 30/DF 10	59 542 03	DF 10	L=72	∅30		
BEM 20/BEX 15	ISO 30/DF 12	59 542 04	DF 12	L=72	∅32		
BEM 28/BEX 35	ISO 40/DF 6	59 542 05	DF 6	L=81	∅26		
BEM 28/BEX 35	ISO 40/DF 8	59 542 06	DF 8	L=81	∅28		
BEM 28/BEX 35	ISO 40/DF 10	59 542 07	DF 10	L=81	∅30		
BEM 28/BEX 35	ISO 40/DF 12	59 542 08	DF 12	L=81	∅32		
BEM 28/BEX 35	ISO 40/DF 16	59 542 09	DF 16	L=81	∅38		
BEM 28/BEX 35	ISO 40/DF 20	59 542 10	DF 20	L=81	∅42		
BEM 28/BEX 35	ISO 40/DF 32	59 542 11	DF 32	L=81	∅63		
BEM 28/BEX 35	ISO 40/WE 2	59 543 03	WE 2	L=59	∅36		
BEM 28/BEX 35	ISO 40/WE 3	59 543 04	WE 3	L=97	∅53		
BEM 28/BEX 35	ISO 40/WE 4	59 543 05	WE 4	L=149	∅78		
BEM 28/BEX 35	ISO 40/WE 5	59 543 06	WE 5	L=165	∅96		
BEM 20 BEX 15 ISO	ISO 30/FLI 30	58 659 01	EM ∅42	L=87	∅69		<ul style="list-style-type: none"> ● Fließbohrfutter für Spannzange ER 25 ▲ Flow drill toolholder for ER 25 collets ■ Mandrin pour fluoperçage par pince ER 25
BEM 28/BEX 35	ISO 40/HSK 40	59 544 01	HSK 40	L=40	∅40		
BEM 28/BEX 35	ISO 40/HSK 50	59 544 02	HSK 50	L=60	∅50		
BEM 28/BEX 35	ISO 40/HSK 63	59 544 03	HSK 63	L=75	∅63		<ul style="list-style-type: none"> ● Hohlenschaft-Werkzeughalter HSK-A, Handspannung, Seite G 12 ▲ Hollow shaft toolholder HSK-A, manual chucking, page G 12 ■ Mandrin cône-creux HSK-A, serrage manuel, page G 12



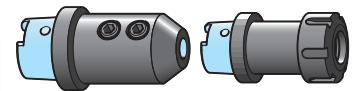

● Hohlenschaft-Werkzeughalter HSK, DIN 69893, für manuellen Wechsel

▲ Hollow shaft toolholder HSK, DIN 69893, for manual tool change

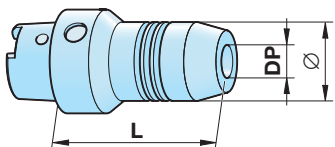
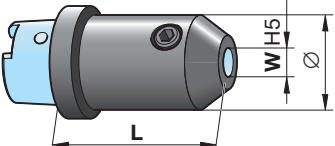
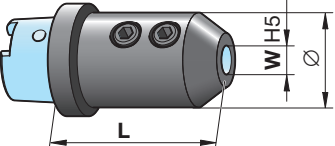

■ Mandrin à cône-creux HSK, DIN 69893, pour changement manuel

HSK 50 - HSK 63

● Geeignet für: ▲ Used with: ■ Se monte sur:	● Typ ▲ Type ■ Type	● Best.-Nr. ▲ Order No. ■ N° de cde.	● Abmessungen für Aufbau ▲ Assembly dimensions ■ Cotations pour implantation	● Bezeichnung ▲ Description ■ Désignation
BEM 20/BEX 15	HSK 50/DP 6	59 545 01	DP 6 L=62 Ø26	<p>● Hydraulik-Dehnspannfutter für Werkzeugtoleranz h6 bei Ø 6 und 8 mm, h7 bei Ø 10 bis 20 mm</p> <p>▲ Hydraulic expansion chuck, for tool tolerance h6 Ø 6 and 8 mm, h7 Ø 10 to 20 mm</p> <p>■ Mandrin expansible hydraulique pour outil h6 Ø 6 et 8 mm, h7 Ø 10 à 20 mm</p>
BEM 20/BEX 15	HSK 50/DP 8	59 545 02	DP 8 L=62 Ø28	
BEM 20/BEX 15	HSK 50/DP 10	59 545 03	DP 10 L=67 Ø30	
BEM 20/BEX 15	HSK 50/DP 12	59 545 04	DP 12 L=77 Ø32	
BEM 20/BEX 15	HSK 50/DP 16	59 545 05	DP 16 L=82 Ø38	
BEM 20/BEX 15	HSK 50/DP 20	59 545 06	DP 20 L=82 Ø42	
BEX 35	HSK 63/DP 6	59 545 11	DP 6 L=62 Ø26	
BEX 35	HSK 63/DP 8	59 545 12	DP 8 L=62 Ø28	
BEX 35	HSK 63/DP 10	59 545 13	DP 10 L=67 Ø30	
BEX 35	HSK 63/DP 12	59 545 14	DP 12 L=77 Ø32	
BEX 35	HSK 63/DP 16	59 545 15	DP 16 L=82 Ø38	
BEX 35	HSK 63/DP 20	59 545 16	DP 20 L=82 Ø42	
BEM 20/BEX 15	HSK 50/W 6	59 545 21	W 6 L=60 Ø25	 <p>● Ausführung bis Ø 20 mm ▲ Design up to dia. 20 mm ■ Exécution jusqu'au Ø 20 mm</p>
BEM 20/BEX 15	HSK 50/W 8	59 545 22	W 8 L=60 Ø28	
BEM 20/BEX 15	HSK 50/W 10	59 545 23	W 10 L=65 Ø35	
BEM 20/BEX 15	HSK 50/W 12	59 545 24	W 12 L=75 Ø42	
BEM 20/BEX 15	HSK 50/W 14	59 545 25	W 14 L=75 Ø44	
BEM 20/BEX 15	HSK 50/W 16	59 545 26	W 16 L=80 Ø48	
BEM 20/BEX 15	HSK 50/W 18	59 545 27	W 18 L=80 Ø50	<p>● Zylinderschaftaufnahme nach DIN 1835-2, Form E (Whistle notch)</p> <p>▲ Side lock holder according to DIN 1835-2, form E (Whistle notch)</p> <p>■ Mandrin de serrage cylindrique, selon DIN 1835-2, forme E (Whistle notch)</p>
BEM 20/BEX 15	HSK 50/W 20	59 545 28	W 20 L=80 Ø52	
BEX 35	HSK 63/W 6	59 545 31	W 6 L=60 Ø25	
BEX 35	HSK 63/W 8	59 545 32	W 8 L=60 Ø28	
BEX 35	HSK 63/W 10	59 545 33	W 10 L=65 Ø35	
BEX 35	HSK 63/W 12	59 545 34	W 12 L=75 Ø42	
BEX 35	HSK 63/W 14	59 545 35	W 14 L=75 Ø44	 <p>● Ausführung ab Ø 25 mm ▲ Design from dia. 25 mm ■ Exécution à partir de Ø 25 mm</p>
BEX 35	HSK 63/W 16	59 545 36	W 16 L=80 Ø48	
BEX 35	HSK 63/W 18	59 545 37	W 18 L=80 Ø50	
BEX 35	HSK 63/W 20	59 545 38	W 20 L=80 Ø52	
BEX 35	HSK 63/W 25	59 545 39	W 25 L=95 Ø65	
BEX 35	HSK 63/W 32	59 545 40	W 32 L=100 Ø72	
BEM 20/BEX 15	HSK 50/ER 16	59 545 51	ER 16 L=60 Ø28	<p>● Spannzangenhalter für ER-Spannzange, Seite G 03</p> <p>▲ Collet chuck for collet ER, page G 03</p> <p>■ Mandrin pour pince ER, page G 03</p>
BEM 20/BEX 15	HSK 50/ER 32	59 545 52	ER 32 L=75 Ø50	
BEX 35	HSK 63/ER 16	59 545 53	ER 16 L=100 Ø28	
BEX 35	HSK 63/ER 32	59 545 54	ER 32 L=100 Ø50	

G12

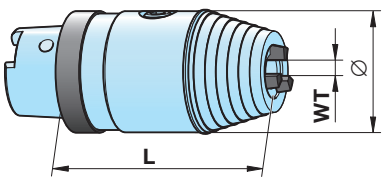
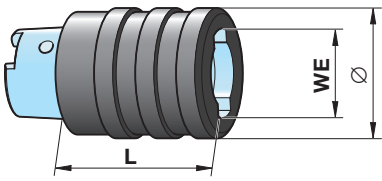
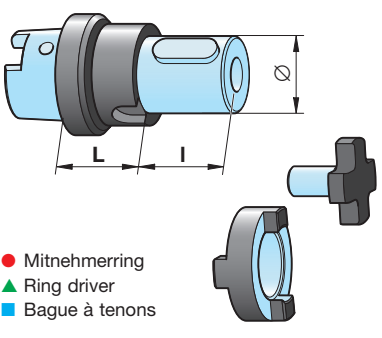
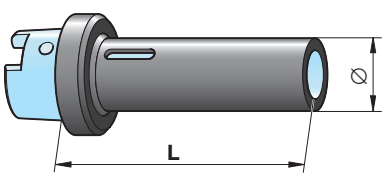
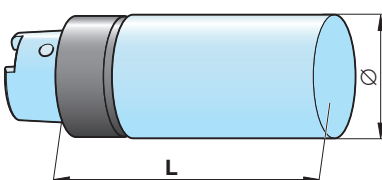
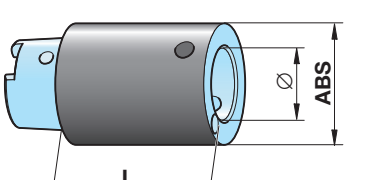

● Geeignet für: ▲ Used with: ■ Se monte sur:	● Typ ▲ Type ■ Type	● Best.-Nr. ▲ Order No. ■ N° de cde.	● Abmessungen für Aufbau ▲ Assembly dimensions ■ Cotations pour implantation	● Bezeichnung ▲ Description ■ Désignation
BEM 20/BEX 15	HSK 50/WT 8	59 546 01	WT 0,5-8 L=98 Ø 36	 <ul style="list-style-type: none"> ● CNC-Universalspindelbohrfutter, bis 35 000 min⁻¹, 30, 80, 90 Nm ▲ NC drill chucks, up to 35 000 RPM, 30, 80, 90 Nm ■ Mandrin de perçage NC, jusqu'à 35 000 t.min⁻¹, 30, 80, 90 Nm
BEM 20/BEX 15	HSK 50/WT 9	59 546 02	WT 1-13 L=98 Ø 50	
BEX 35	HSK 63/WT 10	59 546 03	WT 0,5-8 L=99 Ø 36	
BEX 35	HSK 63/WT 11	59 546 04	WT 1-13 L=98 Ø 50	
BEX 35	HSK 63/WT 12	59 546 05	WT 3-16 L=103 Ø 50	
BEM 20/BEX 15	HSK 50/WE 2	59 546 11	WE 2 L=81 Ø 60	 <ul style="list-style-type: none"> ● Gewindeschneid-Schnellwechselfutter, Druck, Zug ▲ Quick-change spindle adapter. Tension and compression ■ Mandrin de taraudage à changement rapide, compression, extension
BEX 35	HSK 63/WE 2	59 546 13	WE 2 L=71 Ø 60	
BEX 35	HSK 63/WE 3	59 546 14	WE 3 L=115 Ø 86	
BEM 20/BEX 15	HSK 50/FD 16	59 546 21	Ø 16 L=40 l=27	 <ul style="list-style-type: none"> ● Kombi-Aufsteckfräsdorne zur Aufnahme von Fräsern mit Längs- und Quernut ▲ Combination face mill adapter for cutters with transversal slot or key drive ■ Mandrin à double usage pour fraise avec rainures en long et transversal <p>● Mitnehmerring ▲ Ring driver ■ Bague à tenons</p>
BEM 20/BEX 15	HSK 50/FD 22	59 546 22	Ø 22 L=38 l=31	
BEM 20/BEX 15	HSK 50/FD 27	59 546 23	Ø 27 L=53 l=33	
BEM 20/BEX 15	HSK 50/FD 32	59 546 24	Ø 32 L=51 l=38	
BEX 35	HSK 63/FD 16	59 546 25	Ø 16 L=40 l=27	
BEX 35	HSK 63/FD 22	59 546 26	Ø 22 L=38 l=31	
BEX 35	HSK 63/FD 27	59 546 27	Ø 27 L=53 l=33	
BEX 35	HSK 63/FD 32	59 546 28	Ø 32 L=51 l=38	
BEX 35	HSK 63/FD 40	59 546 29	Ø 40 L=56 l=41	
BEM 20/BEX 15	HSK 50/MK 1	59 546 31	MK 1 L=100 Ø 25	 <ul style="list-style-type: none"> ● Morsekegel-Einsatzhülse mit Antriebslappen DIN 228B ▲ Morse taper adapters and flat tang DIN 228B ■ Douille cône-morse avec tenon DIN 228B
BEM 20/BEX 15	HSK 50/MK 2	59 546 32	MK 2 L=120 Ø 32	
BEM 20/BEX 15	HSK 50/MK 3	59 546 33	MK 3 L=140 Ø 40	
BEX 35	HSK 63/MK 1	59 546 34	MK 1 L=100 Ø 25	
BEX 35	HSK 63/MK 2	59 546 35	MK 2 L=120 Ø 32	
BEX 35	HSK 63/MK 3	59 546 36	MK 3 L=140 Ø 40	
BEX 35	HSK 63/MK 4	59 546 37	MK 4 L=160 Ø 48	
BEM 20/BEX 15	HSK 50/RG 1	59 546 41	HSK 50 L=200 Ø 64	 <ul style="list-style-type: none"> ● Rohlinge für die Herstellung von Sonderwerkzeugen Ø=HRC 28-32/HSK=HRC 60 ▲ Spindle adapter blanks for special purpose tooling Ø=HRC 28-32/HSK=HRC 60 ■ Ebauche pour réalisation outils spéciaux Ø=HRC 28-32/HSK=HRC 60
BEX 35	HSK 63/RG 1	59 546 42	HSK 63 L=200 Ø 81	
BEM 20/BEX 15	HSK 50/A 25	59 546 51	ABS 25 L=50 Ø 13	 <ul style="list-style-type: none"> ● ABS-Aufnahmen für Werkzeugaufnahmen Seite G 14 ▲ ABS adapters for end mill adapter page G 14 ■ Mandrin ABS pour les porte-outil en page G 14
BEM 20/BEX 15	HSK 50/A 32	59 546 52	ABS 32 L=50 Ø 16	
BEM 20/BEX 15	HSK 50/A 40	59 546 53	ABS 40 L=60 Ø 20	
BEM 20/BEX 15	HSK 50/A 50	59 546 54	ABS 50 L=70 Ø 28	
BEX 35	HSK 63/A 25	59 546 55	ABS 25 L=50 Ø 13	
BEX 35	HSK 63/A 32	59 546 56	ABS 32 L=50 Ø 16	
BEX 35	HSK 63/A 40	59 546 57	ABS 40 L=60 Ø 20	
BEX 35	HSK 63/A 50	59 546 58	ABS 50 L=70 Ø 28	
BEX 35	HSK 63/A 63	59 546 59	ABS 63 L=80 Ø 34	
BEX 35	HSK 63/A 80	59 546 60	ABS 80 L=100 Ø 46	
BEX 15	HSK 50/MV	59 899 01	HSK 50 L=11 Ø 50	 <ul style="list-style-type: none"> ● Messingverschlussringe ▲ Brass collars ■ Bague d'arrêt en laiton
BEX 35/BEX 45	HSK 63/MV	59 899 02	HSK 63 L=14 Ø 63	
BEX 65	HSK 100/MV	59 899 03	HSK 100 L=23 Ø 100	



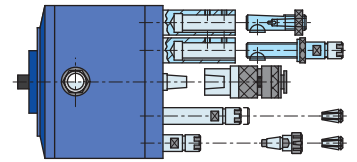

● Werkzeugspannsysteme für Mehrspindelköpfe Typ MHS

▲ Toolholder systems for multiple-spindle heads type MHS

■ Système porte-outils pour têtes multibroches type MHS



G16



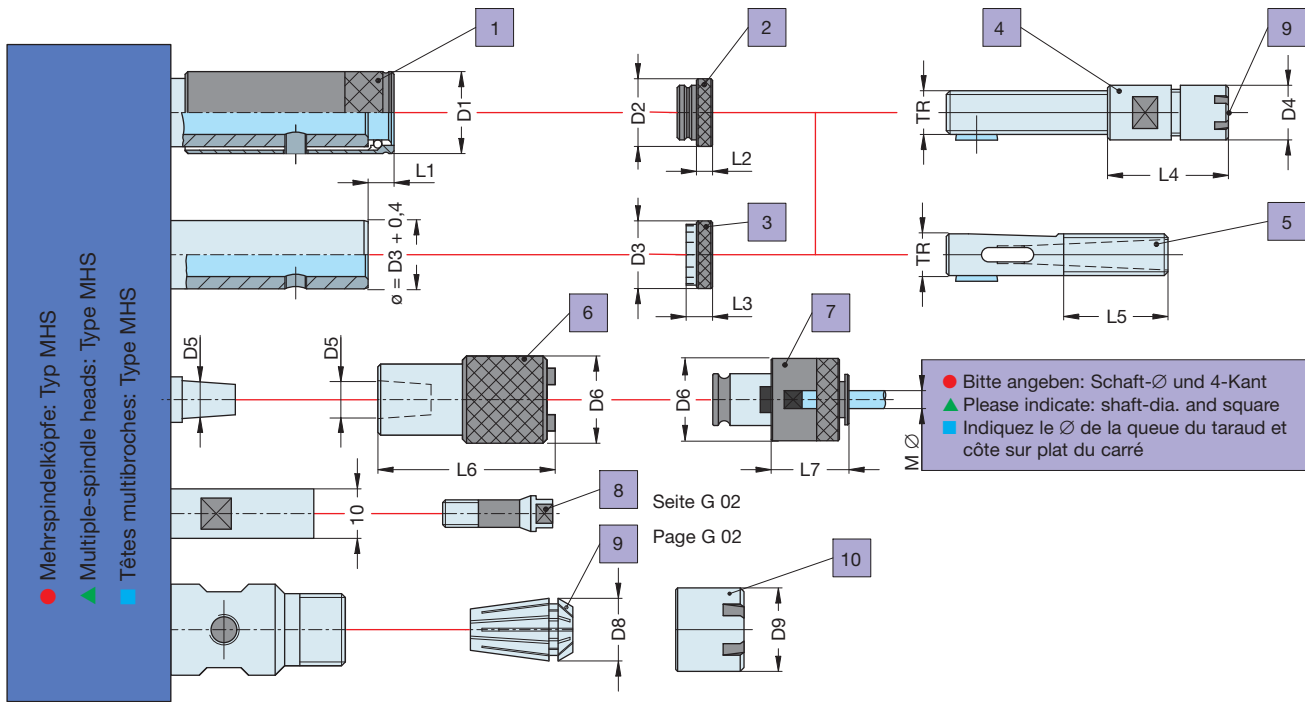

1	● Schnellwechselfutter ▲ Quick-ch. toolholder ■ Mandrin à ch. rapide	Type	ASBA 12	ASBA 16	ASBA 20	ASBA 25	ASBA 28	ASBA 32
		Order No.	58 722 01	907 109	58 722 02	58 722 03	907 110	58 722 04
2	● Stellmutter ▲ Quick-ch. adj. lock nut ■ Ecrou de réglage	Type	SSM 12	SSM 16	SSM 20	SSM 25	SSM 28	SSM 32
		Order No.	58 723 01	907 112	58 723 02	58 723 03	907 114	58 723 04
3	● Stellmutter ▲ Adjustment lock nut ■ Ecrou de réglage	Type	SM 12	SM 16	SM 20	SM 25	SM 28	SM 32
		Order No.	58 724 01	907 113	58 724 02	58 724 03	907 115	58 724 04
4	● Stellhülse-Spannzangenfutter ▲ Automotive collet toolholder ■ Douille porte-pince	Type	SH12 / ER11	SH16 / ER16	SH20 / ER20	—	SH28 / ER25	—
		Order No.	58 725 01	907 120	58 725 02	—	907 125	—
		TR	12 x 1,5	16 x 1,5	20 x 2	—	28 x 2	—
5	● Stellhülse mit Morsekonusaufnahme DIN 6327 ▲ Automotive morse taper toolholder DIN 6327 ■ DIN 6327 Douille réglable pour cône Morse	Type	D12 - 6	D16 - 0	D20 - 1	D25 - 1	D28 - 1	D 32 - 2
		Order No.	58 726 01	907 116	58 726 02	58 726 03	907 121	58 726 04
		TR	12 x 1,5	16 x 1,5	20 x 2	25 x 2	28 x 2	32 x 3
		Type	—	D16 - 1	—	D25 - 2	D28 - 2	D 32 - 3
		Order No.	—	907 117	—	58 726 05	907 122	58 726 06
		TR	—	16 x 1,5	—	25 x 2	28 x 2	32 x 3
6	● Gewindeschneid-Schnellwechselfutter ▲ Quick-change tap holder ■ Porte-taraud à changement rapide	Type	WF0 / B10	WF0 / B12	WF1 / B12	WF1 / B16	WF2 / B16	WF2 / B18
		Order No.	58 727 01	907 252	58 727 03	906 749	58 727 05	58 727 06
		M / Ø	M1 - M10 / Ø2,5 - 7,2	M1 - M10 / Ø2,5 - 7,2	M3 - M12 / Ø3,5 - 11,3	M3 - M12 / Ø3,5 - 11,3	M8 - M20 / Ø7 - 18	M8 - M20 / Ø7 - 18
7	● Einsatz mit Sicherheitskupplung ▲ Tap insert with safety clutch ■ Adaptateur taraud avec friction	Type	WES0B	WES0B	WES1B	WES1B	WES2B	WES2B
		Order No.	58 728 01	58 728 02	58 728 03	58 728 04	58 728 05	58 728 06
		M / Ø	M1 - M10	M1 - M10	M3 - M12	M3 - M12	M8 - M20	M8 - M20
10	● Spannmutter ▲ Collet nut ■ Ecrou serrage	Type / No.	ER-8-M / 921 266 00	ER-11-M / 921 267 00	ER-16-M / 921 268 00	ER-20-M / 921 269 00	ER-25-M / 921 270 00	
		Order No.	D8 = ER8 D9 = 12	D8 = ER11 D9 = 15,8	D8 = ER16 D9 = 21	D8 = ER20 D9 = 27	D8 = ER25 D9 = 35	

