

430TB INTERFACE C TEE CONNECTOR

Application

Separable tee shape connector (bolted type) designed to connect polymeric insulated cable to equipment (transformers, switchgear, motors, ...).

Also connects cable to cable when using the appropriate mating parts.

Technical characteristics

- A thick conductive EPDM jacket provides a total safe to touch screen.
- Each separable connector is tested for AC withstand and partial discharge prior to leaving the factory.

Up to 36 kV
630 A (800 A)

6/10 (12) kV
6.35/11 (12) kV
8.7/15 (17.5) kV
12/20 (24) kV
12.7/22 (24) kV
18/30 (36) kV
19/33 (36) kV

Design

Separable connector comprising:

1. Conductive EPDM insert.
2. Conductive EPDM jacket.
3. Insulating EPDM layer moulded between the insert and the jacket.
4. Type C interface as described by CENELEC EN 50180 and 50181.
5. Conductor connector.
6. Basic insulating plug (with VD point).
7. Cable reducer.
8. Conductive rubber cap.
9. Clamping screw.
10. Earthing lead.

The screen break design enables cable outer sheath testing without removing or dismantling the connector.

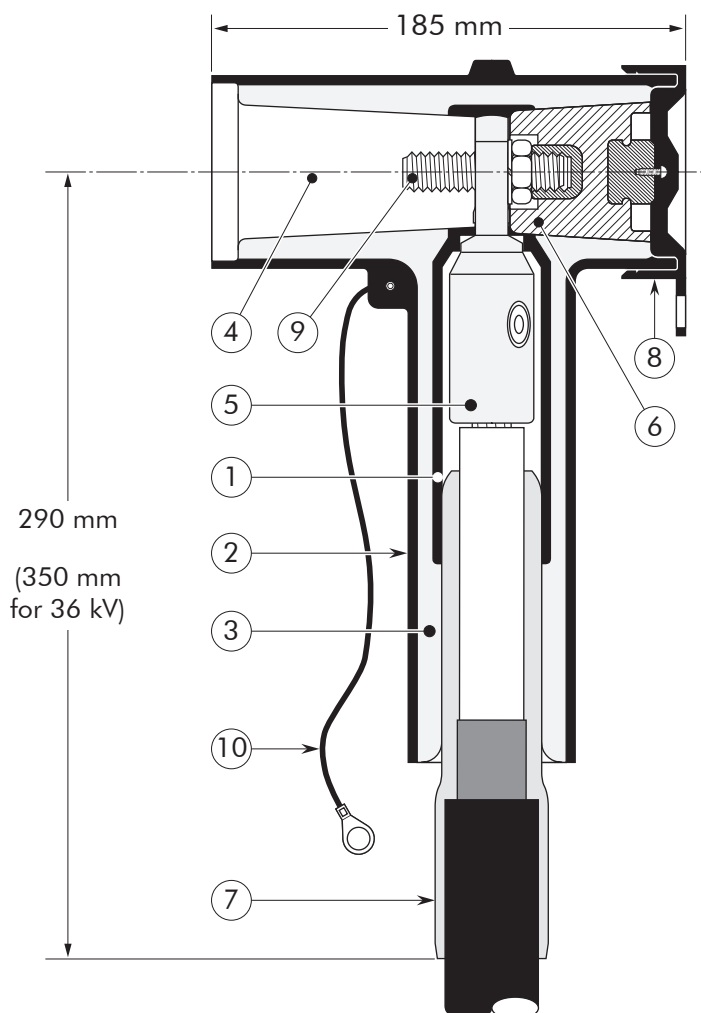

Specifications and standards

The 430TB separable connector meets the requirements of CENELEC HD 629.1.

Separable connector type	Voltage U_m (kV)	Current I_r (A)	Current I_r (A) When installed on an appropriate equipment bushing and when using a copper (-11-2) or a bolted (-12-5 or -14-5) conductor contact	Conductor sizes (mm ²)	
				min	max
430TB/G	12	630	800	35	300
K430TB/G	24	630	800	35	300
M430TB/G	36	630	800	50	240

Kit contents

The complete (K)(M)430TB/G tee connector kit comprises 3 x the following components:

The kit also comprises silicone grease, field control mastic, installation rod, installation instructions and crimp chart.

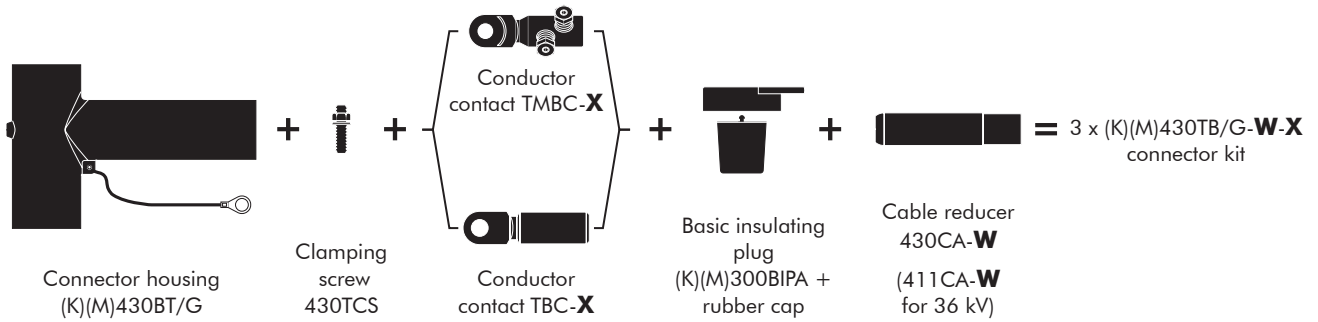

Ordering instructions

To order the tee connector, select the ordering part number which gives you the best centring of your core insulation diameter and substitute **X** using table X, according to your conductor size and type.

Example:

The cable is 24 kV, 150 mm² compact stranded copper with a diameter over core insulation of 27.5 mm.

Order





3 x K430TB/G-18-95.240-14-5 tee connector kit.

Table W

Ordering part number	Voltage (Um) (kV)	Dia. over core insulation (mm)	
		min	max
3 x 430TB/G-11-X	12	12.0	17.5
3 x 430TB/G-16-X	12	17.0	23.5
3 x 430TB/G-18-X	12	19.0	32.6
3 x K430TB/G-11-X	24	12.0	17.5
3 x K430TB/G-16-X	24	17.0	23.5
3 x K430TB/G-18-X	24	19.0	32.6
3 x M430TB/G-11-X	36	12.0	17.5
3 x M430TB/G-15-X	36	16.0	22.0
3 x M430TB/G-19-X	36	20.0	26.5
3 x M430TB/G-22-X	36	23.5	31.0
3 x M430TB/G-25-X	36	26.5	32.5
3 x M430TB/G-27-X	36	28.5	37.5

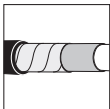
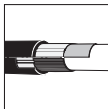
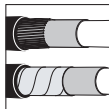
Table X

Conductor sizes (mm ²)	Aluminium conductor			Copper conductor	
	DIN hexagonal	Deep indent	Bolted	DIN hexagonal	Bolted
35	35(K)M-10-2	35KM-10-1	16.95-14-5	35(K)M-11-2	16.95-14-5
50	50(K)M-10-2	50(K)M-10-1		50(K)M-11-2	
70	70(K)M-10-2	70(K)M-10-1	50.150-14-5	70(K)M-11-2	95.240-14-5
95	95(K)M-10-2	95(K)M-10-1		120.300-12-5	
120	120(K)M-10-2	120(K)M-10-1	120.300-12-5		120(K)M-11-2
150	150(K)M-10-2	150(K)M-10-1		120.300-12-5	150(K)M-11-2
185	185(K)M-10-2	185(K)M-10-1	120.300-12-5		185(K)M-11-2
240	240(K)M-10-2	240(K)M-10-1		120.300-12-5	240(K)M-11-2
300	300(K)M-10-2	-	120.300-12-5		300(K)M-11-2

					
For use with copper tape screened cables. Order: Kit MT.	For use with Alupe or C 33-226 cables. Please contact our representative.	For use with easy strip semi-conductive screened cables. Order: Field control mastic (type MFC).	For use with other cable types. Please contact our representative.	For applications outdoors and in humid climate. Order: +MWS.	When installed on an appropriate equipment bushing: 800 A continuously