

WIM200-Q25L-LI-EXI-H1141

Magnetically Actuated Linear Position Sensor

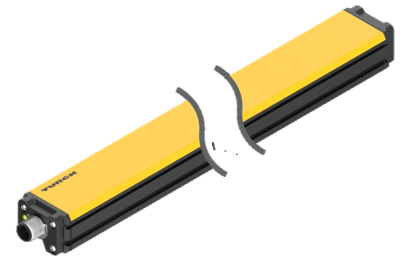
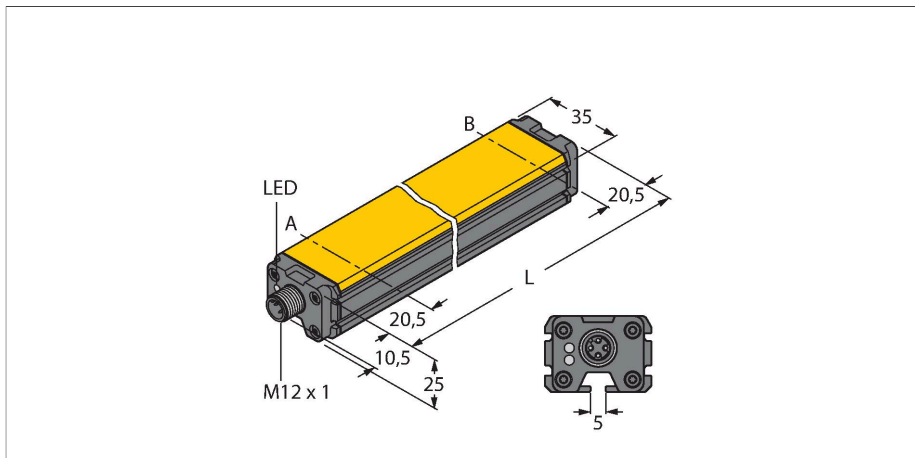

Technical data

Type	WIM200-Q25L-LI-EXI-H1141
ID	1536645
Measuring principle	Magnetic
General data	
Measuring range	200 mm
Resolution	0.2 mm/10 bit
Repeatability	≤ 0.1% of measuring range IA - BI depending on positioning element
Linearity deviation	≤ 1 %
Temperature drift	≤ ± 0.03 % / K
Electrical data	
Operating voltage	14...30 VDC
Residual ripple	≤ 10 % U _{ss}
Isolation test voltage	≤ 0.5 kV
Short-circuit protection	yes
Wire breakage/Reverse polarity protection	yes / Complete
Output function	4-pin, Analog output
Current output	4...20 mA
Load resistance current output	≤ [(U _B - 14 V) / 20 mA] kΩ
Sample rate	200 Hz
Approval acc. to	KEMA 03 ATEX 1122 X Issue no. 2
Internal capacitance (C _i)/inductance (L _i)	0 nF/0 μH
Device marking	Ⓔ II 2 G Ex ia IIC T6 Gb / II 2 D Ex ia II-IC T85 °C Db (max. U _i = 30V, I _i = 120mA, P _i = 675mW)
Mechanical data	
Design	Profile, Q25L

Features

- Rectangular, aluminium / plastic
- Many mounting possibilities
- Immune to external magnetic fields
- Extremely short blind zones
- 2-wire, 14...30 VDC
- Analog output
- 4 ... 20 mA
- Male connector, M12 x 1

Wiring diagram

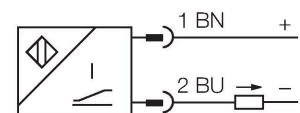

Functional principle

Linear position sensors operate on the Hall principle and accomplish simple control tasks. They provide an output signal proportional to the actuating magnet. The polarity of the magnet has no effect on the output signal. The outstanding features of these robust sensors are excellent repeatability, resolution and linearity, excellent electromagnetic capability and a broad temperature range.

Technical data

Dimensions	241 x 35 x 25 mm
Housing material	Aluminum/plastic, PA6-GF30
Active area material	Plastic, PA6-GF30
Electrical connection	Connector, M12 × 1
Environmental conditions	
Ambient temperature	-25...+65 °C
	For explosion hazardous areas see instruction leaflet
Vibration resistance	55 Hz (1 mm)
Shock resistance	30 g (11 ms)
Protection class	IP67
MTTF	131 years

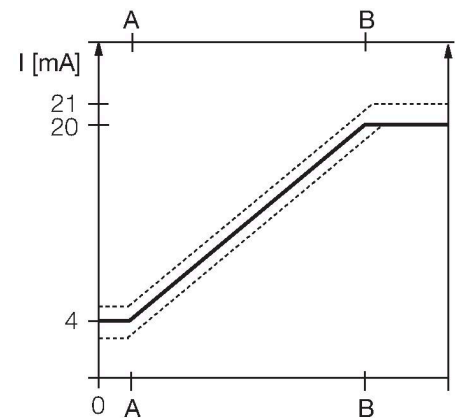

Mounting instructions

Mounting instructions/Description

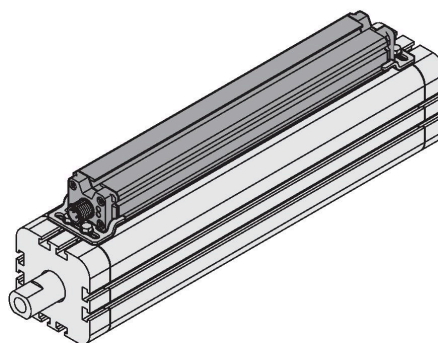
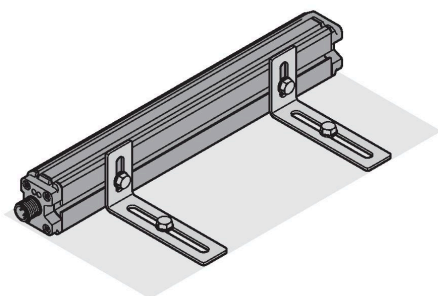
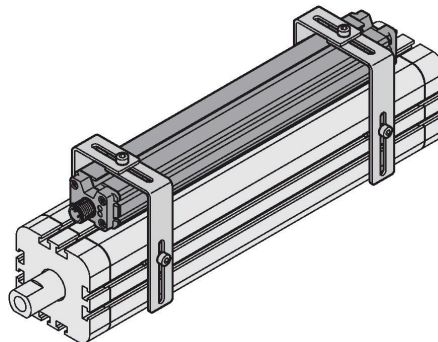
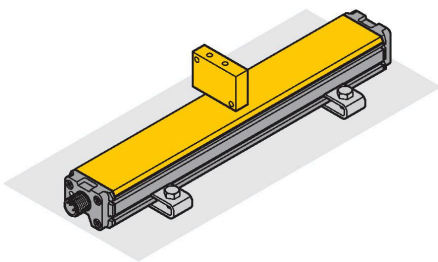

Numerous accessories allow the sensor to be mounted in various positions. Opposite to the active face, the sensor housing features a mounting groove for which sliding blocks are available. The lateral slot profiles can be used for mounting, too.

When used with an external positioning element, the sensor can either be mounted with the active face located opposite or laterally to the mounting surface. Drilling slots guarantee highest flexibility for fine adjustment.

The mounting accessories for linear position sensors can be adjusted to the respective cylinder sizes. The stainless steel accessories guarantee safe and robust mounting as well as highest flexibility.

Accessories

M1-Q25L

6901045

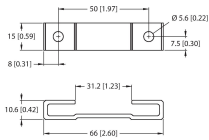

Mounting foot for linear position sensors LI-Q25L; material: aluminum; 2 pcs. per bag

M2-Q25L

6901046

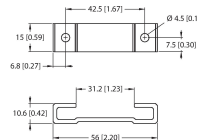

Mounting foot for linear position sensors LI-Q25L; material: aluminum; 2 pcs. per bag

MB1-Q25

6901026

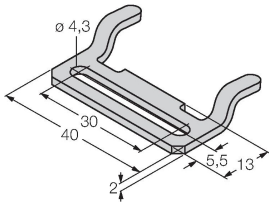

Mounting clip for linear position sensor Q25L; material: Stainless steel; 2 pcs. per bag

MB2.1-Q25

6901027

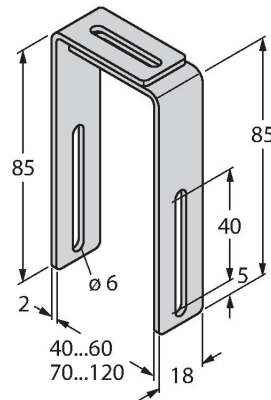

Mounting bracket for linear position sensors Q25L for mounting on pneumatic cylinders (40...60 mm); material: Stainless steel; 4 pcs. per bag

MB2.2-Q25(4PCS)

6901028

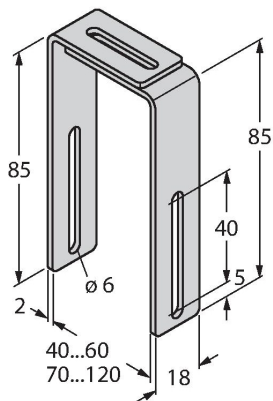

Mounting bracket for linear position sensors Q25L, for mounting on pneumatic cylinders (70...120 mm); material: Stainless steel; 4 pcs. per bag

M4-Q25L

6901048

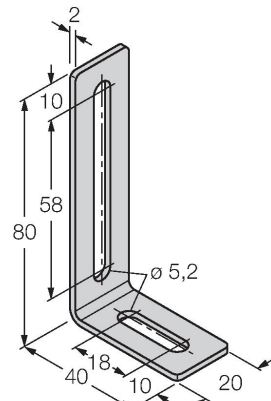

Mounting bracket and sliding block for linear position sensors LI-Q25L; material: Stainless steel; 2 pcs. per bag

MN-M4-Q25

6901025

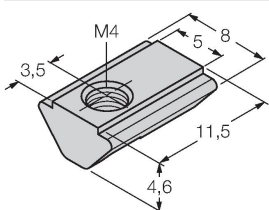

Sliding block with M4 thread for the backside profile of the LI-Q25L; material: galvanized steel; 10 pcs. per bag

MN-M5-Q25

6901039

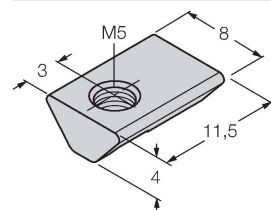

Sliding block with M5 thread for the backside profile of the LI-Q25L; material: Stainless steel; 10 pcs. per bag

DM-Q12

6900367

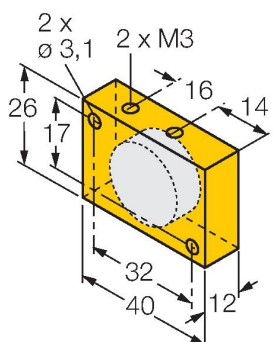

Actuator, rectangular, plastic, attainable switching distance 58 mm on BIM-(E)M12 magnetic field sensors or 49 mm on BIM-EG08 magnetic field sensors; for Q25L linear position sensors: recommended distance between the sensor and magnet: 3...5 mm

DMR15-6-3

6900216

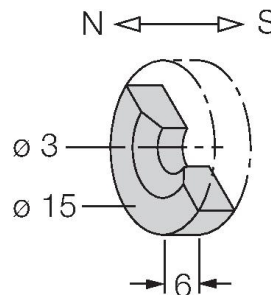

Actuation magnet, \varnothing 15 mm (\varnothing 3 mm), h: 6 mm; attainable switching distance 36 mm on BIM-(E)M12 magnetic field sensors or 32 mm on BIM-EG08 magnetic field sensors; for Q25L linear position sensors: recommended distance between the sensor and magnet: 3...4 mm

DMR20-10-4 6900214

Actuation magnet; \varnothing 20 mm (\varnothing 4 mm), h: 10 mm; attainable switching distance 59 mm on BIM-(E)M12 magnetic field sensors or 50 mm on BIM-EG08 magnetic field sensors; for Q25L linear position sensors: recommended distance between the sensor and magnet: 3...4 mm

DMR31-15-5 6900215

Actuation magnet, \varnothing 31 mm (\varnothing 5 mm), h: 15 mm; attainable switching distance 90 mm on BIM-(E)M12 magnetic field sensors or 78 mm on BIM-EG08 magnetic field sensors; for Q25L linear position sensors: recommended distance between the sensor and magnet: 3...5 mm

P1-WIM-Q25L 6901088

Guided positioning element for WIM-Q25L, inserted in the sensor groove.

Accessories

Dimension drawing	Type	ID	
	IMX12-AI01-2I-2IU-H0/24VDC	7580305	Isolating transducer; 2-channel; power supply of passive 2-wire isolating transducers with HART communication as well as connection of active 2-wire transmitters, SIL2 acc. to IEC61508; Ex-proof version; selectable with either current source/sink or voltage output; removable screw terminals; 24 VDC power supply

Instructions for use

Intended use	This device fulfills the directive 2014/34/EC and is suited for use in explosion hazardous areas according to EN60079-0:2012 + A11 -11:2012. In order to ensure correct operation to the intended purpose it is required to observe the national regulations and directives.
For use in explosion hazardous areas conform to classification	II 2 G and II 2 D (Group II, Category 2 G, electrical equipment for gaseous atmospheres and category 2 D, electrical equipment for dust atmospheres)
Marking (see device or technical data sheet)	<p>⊕ II 2 G Ex ia IIC T6 Gb and ⊕ II 2 D Ex ia IIIC T85 °C Db acc. to EN 60079-0, -11</p> <p>⊕ II 2 D and Ex ia IIIC T100°C Db acc. to EN61241</p>
Local admissible ambient temperature	-25...+66 °C
Installation/Commissioning	<p>These devices may only be installed, connected and operated by trained and qualified staff. Qualified staff must have knowledge of protection classes, directives and regulations concerning electrical equipment designed for use in explosion hazardous areas. Please verify that the classification and the marking on the device comply with the actual application conditions.</p> <p>This device is only suited for connection to approved Exi circuits according to EN 60079-0 and EN 60079-11. Please observe the maximum admissible electrical values. After connection to other circuits the sensor may no longer be used in Exi installations. When interconnected to (associated) electrical equipment, it is required to perform the "Proof of intrinsic safety" (EN60079-14).</p>
Installation and mounting instructions	Avoid static charging of cables and plastic devices. Please only clean the device with a damp cloth. Do not install the device in a dust flow and avoid build-up of dust deposits on the device. If the devices and the cable could be subject to mechanical damage, they must be protected accordingly. They must also be shielded against strong electro-magnetic fields. The pin configuration and the electrical specifications can be taken from the device marking or the technical data sheet. In order to avoid contamination of the device, please remove possible blanking plugs of the cable glands or connectors only shortly before inserting the cable or opening the cable socket.
Special conditions for safe operation	The device must be protected against any kind of mechanical damage, avoid static charging.
Service/Maintenance	Repairs are not possible. The approval expires if the device is repaired or modified by a person other than the manufacturer. The most important data from the approval are listed.