



MULTIFUNCTION ELECTRONIC SYSTEM

New P7 electronic system is a unique multifunction process control device capable of managing the complete machine tool by means of Pre-Process, In-Process, and Post-Process measurement controls; machine vibration monitoring and automatic wheel balancing; optimizing the working and wheel dressing cycles.

IN-PROCESS (1) The workpiece is continuously measured during the grinding process and the machine cycle is adjusted based on the amount of stock to be removed. Marposs In-Process systems optimize feed rates to produce parts with excellent surface finishes, very tight dimensional tolerances and maintain the best cycle time.

POST-PROCESS (2) Marposs Post-Process measurement systems measure critical dimensions on ground or turned parts and is able to generate compensation signals to the machine tool control.

WHEEL BALANCING (3) A properly balanced grinding wheel can improve the surface quality of individual workpieces and extend spindle life. Marposs Wheel Balancer line is the best solution to continuously monitor the grinding wheel condition and compensate the detected imbalance condition of the grinding wheel.

MONITORING (4) Acoustic technology, to detect subtle changes in sounds produced while grinding, can be used for extremely precise machine control when the wheel is touching the part or the dresser. Acoustic systems are particularly useful for preventing collisions and detecting machine and tool abnormalities, such as chipped grinding wheels and dresser faults.

Advantages

- Real time grinding cycle check without the need for a dedicated unit
- Increased machine efficiency
- Reduction in unproductive cycle times
- Improved surface finish quality
- Automatic compensation for wear on the grinding wheel or other tools
- Automatic machine and/or process deviation check
- Measurement insensitive to environmental conditions and to electromagnetic interference generated by machine power devices
- Continuous monitoring of grinding wheel position and condition
- Continuous checking of collision dangers caused by incorrect grinding wheel movements
- Continuous checking of deterioration of the rolling parts

Application

P7 system provides a versatile and capable solution to meet all control and monitoring requirements in the machine tool starting from measurement before, during, and after the grinding process up to continuous vibration monitoring and automatic compensation of wheel imbalance conditions.

Configurable to suit multiple gauge applications, P7 is capable of managing measuring heads, electronic and pneumatic plugs, touch probes, and acoustic emission (AE) sensors.

Features typically requiring high precision control include: inside and outside diameters of bearing races, flat surfaces, shoulders, part thickness and match fit parts. In addition P7 can provide feedback for part position and part recognition. P7 can process both smooth and interrupted surfaces.

Measurement data (from measuring heads, touch and acoustic sensors) are constantly compared with pre-set values providing all the necessary information to optimize the machining and dimensional control processes.

The HW and SW modularity of P7 covers a wide range of applications, such as:

- Single and multiple diameters (both In-Process and Post-Process)
- Simultaneous measurement of two diameters with taper check.
- Pre-Process measurement for the machining of match-ground parts.
- Active or Passive positioning (Lateral Locating).
- In process and/or Post Process independent application capability
- Post process size control feedback using measurement trend calculation.
- Process control and capability index data.

P7 can be connected to all Marposs electro-mechanical balancers to control machine vibrations and dynamically compensate any wheel imbalance to improve the surface finish and geometry of the workpiece, and extend the wheel life.

The availability of different technical solutions and the complete range of balancing heads can solve many kinds of applications, guaranteeing fast balancing cycles, maintenance free life and reducing machine downtime

Benefits

Cost Effective: Integration and control of a wide range of functions within a single and modular unit like measurement, part positioning, wheel balancing, gap control for efficient "wheel-to-part" or "dresser -to-wheel" positioning

Ergonomic: Simple operation. Programmable "Hot Keys" shortcut to frequently used functions. TFT color display of gauging, balancing and survey results and process data.

Productive: Reduction of downtime. The use of wide measurement range (25.4 mm) allows for rapid and automatic part changeover. Balancing cycles accomplished automatically in under one minute, eliminating static balancing and reducing grinder downtime.



IP Measure - Controls



IP Measure - 2 diameters + taper



PP Measure - Bars



PP Measure - Histogram



Automatic Wheel balancing



Gap and Crash controls

Flexibility and Modularity

P7 modular platform permits a wide range of HW and SW options to be configured to suit specific applications. The system is available in different enclosure types with local or remote operator panel, provide mounting solutions for all machine types.

The system utilizes a series of cards to control inputs from a wide range of measurement, electro-mechanical balancer and sensing devices. Other modules provide logical I/O, field bus support and graphic display control.

The P7 memory can accommodate up to several different part programs. These can be created, edited or recalled not only from the operator panel, but also through the machine's CNC control (when using Fieldbus communication), reducing possible human error.

Remapping of the P7 I/O provides for ultimate flexibility.

Ease of Use

Color high - definition display, ergonomic membrane keypad, minimal number of keys, simple icon (ISO 700) driven inter active human interface, are the elements that provide rapid and efficient operator use.

Hotkeys can be programmed freely to the most frequently used function or display pages.

A diagnostic system keeps all functions under control and verifies the validity of programmed parameters.

Safe, Rugged and Environmentally Friendly

The P7 has been developed in accordance with European Community Safety and Electronics directives. P7 elements are housed in a suitably insulated and protected case. They are made of self-extinguishing materials that do not emit dioxin or furans.



Remote panel with graphic display



Integrated mainframes mechanical structures



Integrated mainframe 4 slots - 1/2 19" - 4HE



Integrated mainframe 6 slots - 19" - 3HE

Measuring Heads

Electronic Units

Balancing Heads

Software

Sensors

Accessories

System Hardware

P7 is available in three different drawer versions with a passive back plane that can be configured using different function cards (measurement, wheel balancing, survey, I/O's interfacing) according to the specific application.

CPU MASTER CARD - Utilizing the latest technology in the field of industrial microcontrollers. This guarantees high sampling frequencies increasing all performances even in extreme applications. This card is always present inside the unit for the complete management of the graphic display and function cards.

FIELD BUS CARDS - Made in compliance with Interbus-S and Profibus DP standards. This card can be inserted as an additional module on the CPU Master card.

GRAPHIC DISPLAY - TFT color 5.5" display.

POWER SUPPLY CARD / 24 VDC - This card is always present inside the unit for the complete management of the function cards.

A/E SENSOR and TOUCH PROBE - Acoustic emission control for gap and crash monitoring and for touch probe connection for part locating and grinding wheel set-up environment. This card can be inserted as an additional module on the Power Supply card.

CPU MEASUREMENT CARD - Available for LVDT (full bridge), HBT (half bridge) and Air-Gap transducers. Each module includes the circuit for the electric retraction of the gauge contacts. A transducer expansion card can be inserted on this module to increase measurement capability.

WHEEL BALANCER CPU CARD - Available for balancing heads with optical/infrared transmission system (Contactless) and optical/infrared transmission system equipped with integrated acoustic emission sensor.

CPU SENSORS - Configurable for fixed or contactless, split or ring-shaped acoustic sensors

INTERFACE CARDS - Parallel interface board with 64 programmable Inputs/Outputs to handle machine. Interface logic BCD or Binary.

ETHERNET CARD - Made in compliance with Ethernet communication standards to perform remote P7 connection.

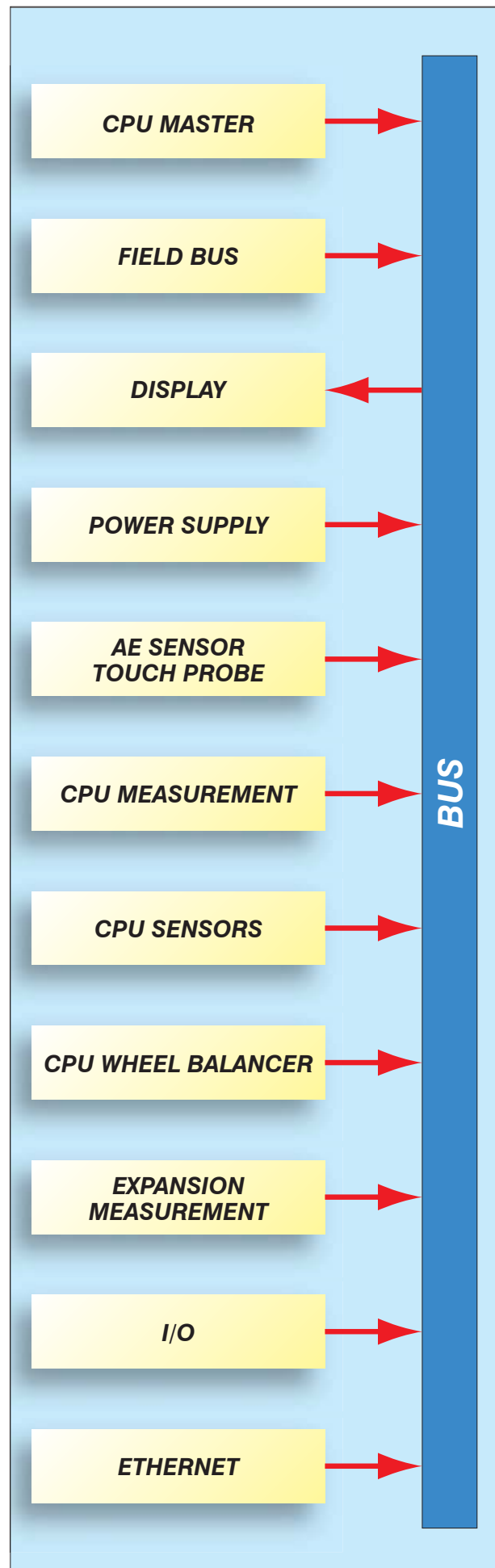

Drawers Rear View

- 1 Integrated mainframe 4 slots - 1/2 19" width and 4 HE height
- 2 Integrated mainframe 6 slots - 19" width and 3 HE height
- 3 Integrated mainframe 8 slots - 19" width and 4 HE height



- J1 Remote Panel connection
- J2 Additional mainframe connection

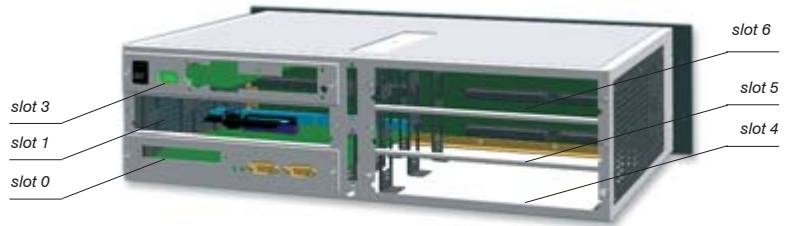

Slot # 0 CPU Master card (always present)

Slot # 3 24 VDC Power Supply card (always present)

Slot #1 ÷ # 7 Functions Cards

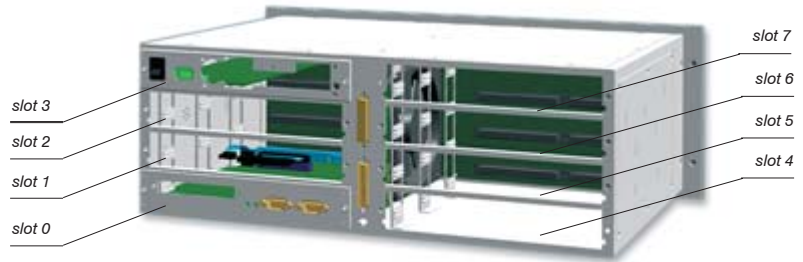

Panel Front View

- 1 Display 5.5" TFT colors 320x240 pixels, 1/4 VGA
- 2 Operating key pad
- 3 Function keys
- 4 Icons

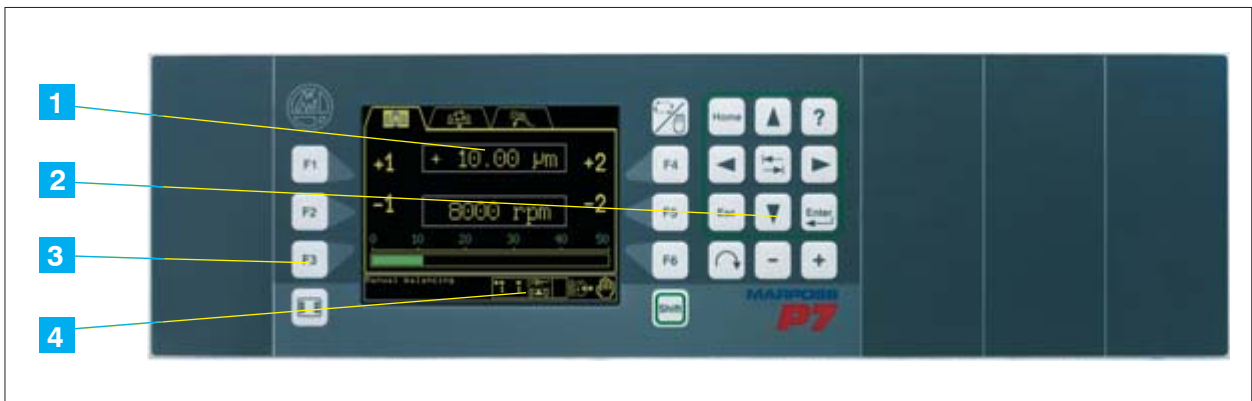

Electronic boards

Master CPU card

All master CPUs have two RS232 serial ports, a system software check LED and a card power check LED.

Possible configurations:

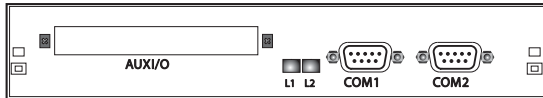

Master CPU card

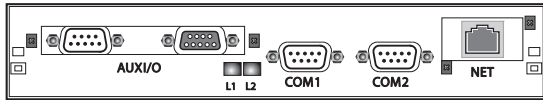

Master CPU card + fieldbus connection (optional) + Ethernet interface (optional)

Card for I/Os, power supply, acoustic sensors and touch sensors

Measurement values are supplied in BCD or binary format through the I/Os.

Possible configurations:

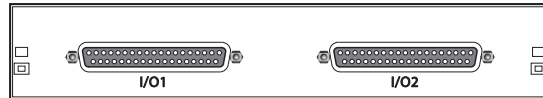

64 I/O card

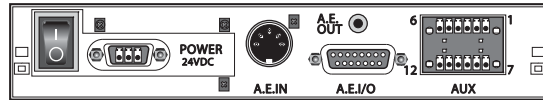

Power supply card + 2 touch probes (optional) + acoustic sensor (optional)

Measurement CPU card

The card which acquires and conditions the signal has connectors for connecting the measuring heads, analog output and temperature sensors with a maximum of 8 channels (4 connectors with modularity level 2).

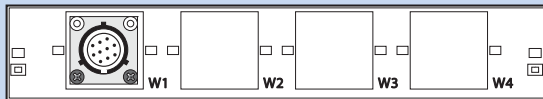

Two-channel card.

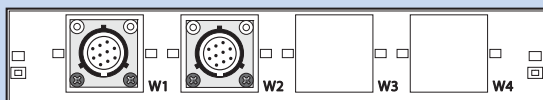

Four-channel card.

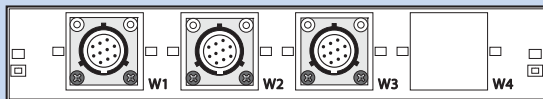

Six-channel card.

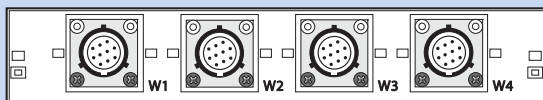

Eight-channel card.

Balancer CPU card

The card which acquires and conditions the signal has connectors for connecting the balancing heads, vibration sensors (accelerometers) and speed of rotation sensors, with a maximum of 2 channels.

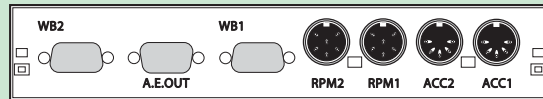

Manual balancing card.

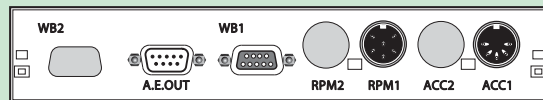

1-channel automatic/manual balancing card.

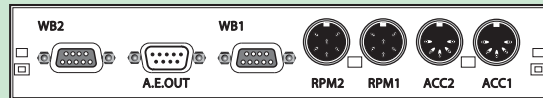

2-channel automatic/manual balancing card.

Sensors CPU card

The card which acquires and conditions the signal has connectors for connecting the acoustic sensors (up to 4 channels), analog output and analog input for auxiliary sensors (up to 2 channels).

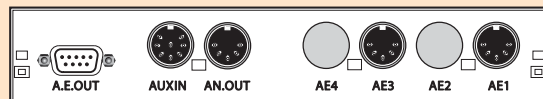

Two-sensor card.

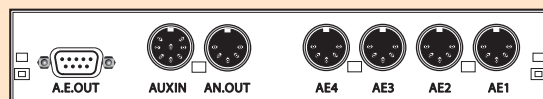

Four-sensor card.

Dimensions for Mainframes, Stand Alone Unit and Panels

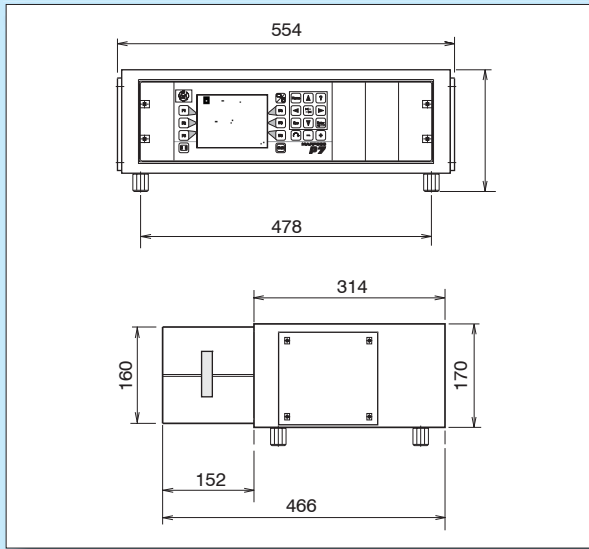

Stand Alone Unit 19" - 3HE

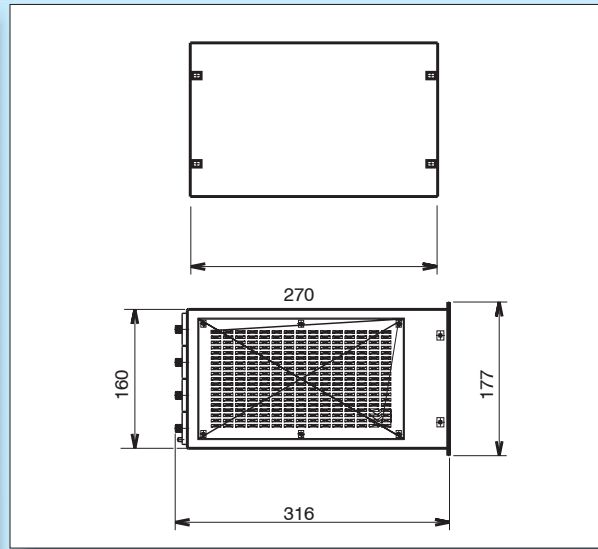

Integrated Mainframe 1/2 19" - 4HE

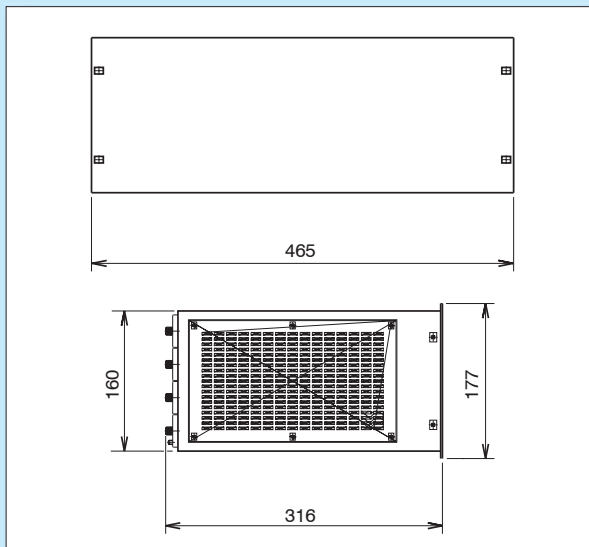

Integrated Mainframe 19" - 4HE

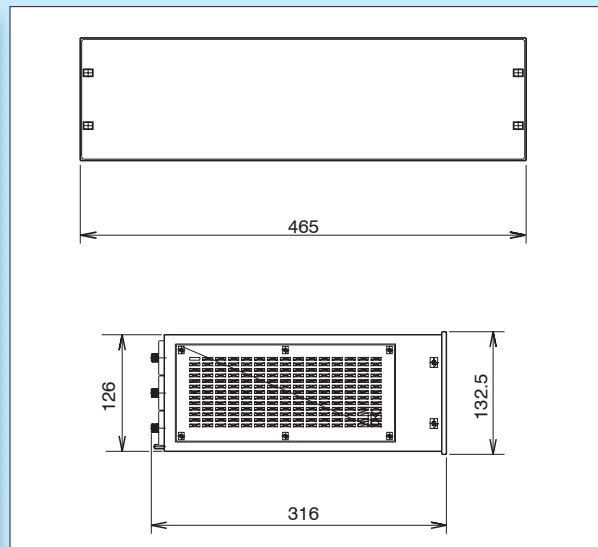

Integrated Mainframe 19" - 3HE

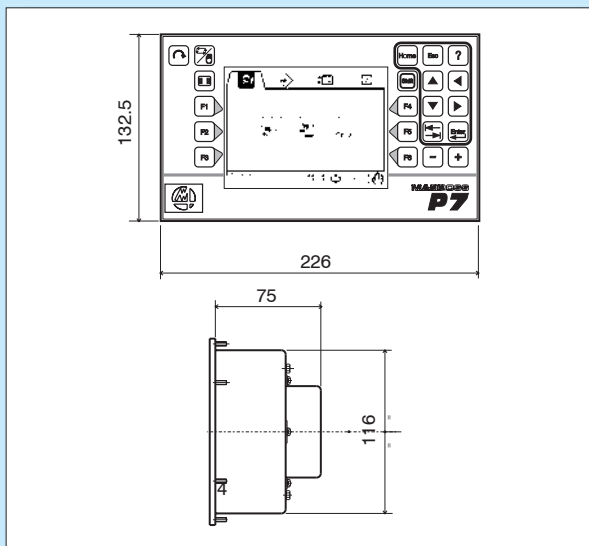

Remote Panel 1/2 19" - 3HE

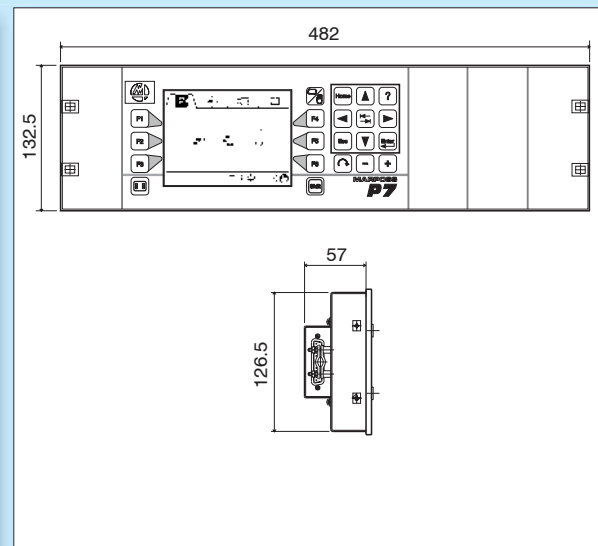

Remote Panel 19" - 3HE

HARDWARE CONFIGURATION

MACHINE INTERFACES		
Optoinsulated configurable BCD or I/O with protected outputs	number of signals	64 programmable I/O
	operating voltage	24 VDC (-15/+20)%
	Sink/Source	Yes
	input current	5mA / 24V
	output current	100mA / 24V
Serial	number of ports (type)	2 (RS232E)
	transmission protocol	according to specific needs
	transmission rate	programmable from 9600 up to 115200 bauds
Field bus	max. connection distance	15 mt (50 feet)
	Yes	Profibus/Interbus-S
Power Supply	voltage	24 VDC (-15/+20)% IEC 1131-2
	consumption	60W

CPU MEASUREMENTS		
Elaboration	speed	2,000 samples/second
Transducers channels	Air Gap, LVDT, HBT	up to 8 channel/4 connectors, modularity 2

EXPANSION MEASUREMENTS		
Transducers channels	Air Gap, LVDT, HBT	up to 8 channel/4 connectors, modularity 2

DISPLAY		
Graphic LCD	dimensions	320 x 240 pxls, ¼ VGA (5,5")
	HW technology	TFT (colors)
	standard measure resolution	0.1 µm (0.000001")
	scales	1000 / 500 / 100 µm (.04" / .02" / .004")
Remote panel	standard balancing resolution	0.01 µm (0.0000001")
	max. remotable distance	30 mt (98 feet)

CPU WHEEL BALANCER		
Elaboration	peak - rms	0 ÷ 50 µm - 0 ÷ 30 mm/s
Logic I/O's for Gap Eliminator and Crash	inputs operating voltage	24 V DC
	Sink / Source	Yes
	outputs type	relays 24 VDC/AC-optoinsulated 24 VDC 10mA

ADDITIONAL FUNCTIONS		
Gap Eliminator & Crash	number of channels	2 (1 Gap + 1 Crash)
	A/E sensor (fixed or rotating)	1
Logic I/O	inputs operating voltage	24 V DC
	Sink / Source	Yes
	output type	relays 24 VDC/AC-optoinsulated 24 VDC 10mA
Analog Output for Gap signal	full-range output voltage	1 Vp
Touch Probe for positioning cycles	logic I/O output type	solid state relays ± 50V / 40 mA External LED connection possible
	response time to touch	30µs (opening), 50µs (closing)

QUALITY & RELIABILITY SPECIFICATIONS

	GENERAL REQUIREMENT ACCORDING TO:	TEST SPECIFICATION ACCORDING TO:
SAFETY: Operating conditions, transport and storage	EN60204	EN60204
EMC IMMUNITY		
- radiated electromagnetic fields	EN61000-4-3 RF Immunity	Acceptance criterion: A
- electrostatic discharge	EN61000-4-2 ESD Immunity	Acceptance criterion: B
- electromagnetic field induced on cables	EN61000-4-6 Conducted RF Immunity	Acceptance criterion: A
- burst on peripheral	EN61000-4-4 EFTB Immunity	Acceptance criterion: B
- magnetic fields	EN61000-4-8 Magnetic Field Immunity	Acceptance criterion: A
- Electromagnetic Emission	CISPR 11	CISPR 11
1) Radiated at high frequencies	from 30 to 1,000 MHz	Passed
2) Conducted Emission	from 0.15 to 30 MHz	Passed



MARPOSS
www.marposs.com

For a full list of address locations, please consult the Marposs official website

D6P00704G0 - Edition 07/2006 - Specifications are subject to modifications
© Copyright 2006 MARPOSS S.p.A. (Italy) - All rights reserved.

MARPOSS, ® and Marposs product names/signs mentioned or shown herein are registered trademarks or trademarks of Marposs in the United States and other countries. The rights, if any, of third parties on trademarks or registered trademarks mentioned in the present publication are acknowledged to the respective owners.

Marposs has an integrated system to manage the Company quality, the environment and safety, attested by ISO 9001, ISO 14001 and OHSAS 18001 certifications. Marposs has further been qualified EAQF 94 and has obtained the Q1-Award.



MARPOSS