

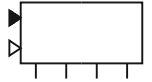

OL-One-line distributor
VOE-B



Use:

In OL[®]-lubrication systems following the one-line system

Technical data:

Operating pressure air: max. 10 bar
min. outlet pressure +1 bar
Operating pressure oil: max. 45 bar
min. outlet pressure +20 bar
Relief pressure oil: <1,2 bar
Medium: Mineral oil
Grade of filtration: ≤3 µm
Operating viscosity
Metering element 1: ≤250 mm²/s
Metering element 2 ... 7: ≤3000 mm²/s
Temperature range: -20 ... +160 °C
Tightening torque of the throttle screw: max. 1 Nm

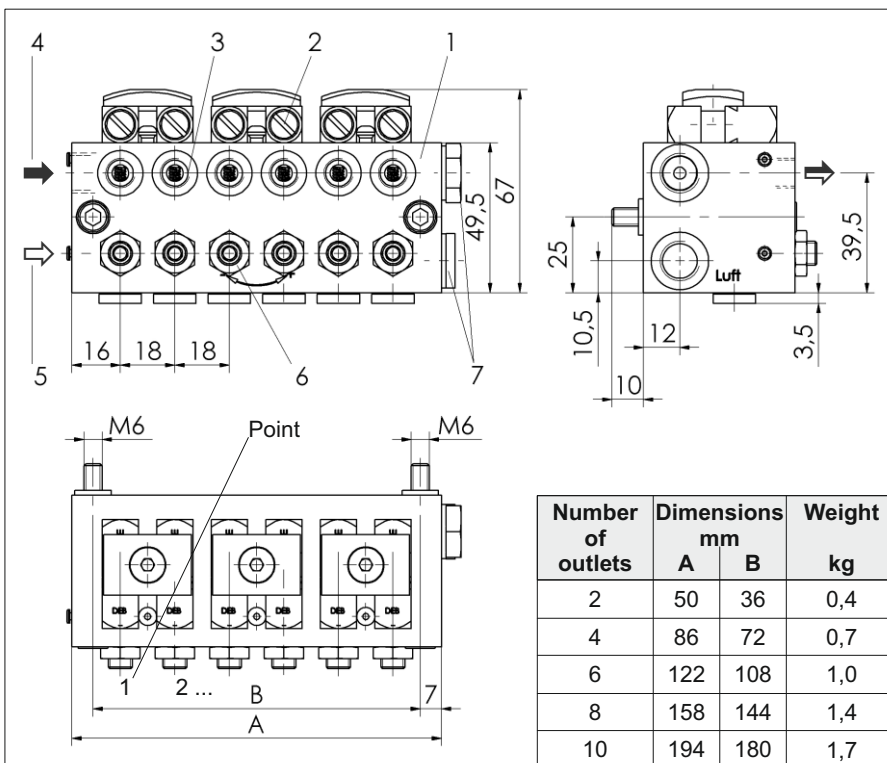

- Subject to modifications -

Note on dimensional drawing:

- Item
- 1 Connection block
 - 2 Metering element
 - 3 Outlet G 1/8
 - 4 Oil connector G 1/4
 - 5 Compressed-air supply G 1/4
 - 6 Air adjustment screw
 - 7 Lock screw
(available for versions with one-sided main line connections only)

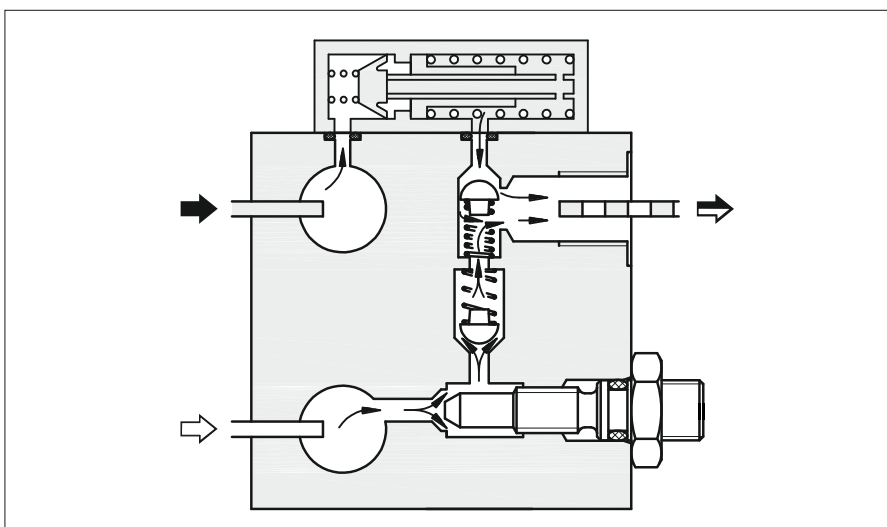

Mode of operation:

The distributor leads the lubricant volumes supplied by the metering elements to the various outlets separately. Every outlet an air adjustment screw is assigned to. Such screw enables the required compressed-air volume to be adjusted.

Outlets, which are not needed, can be provided with dummy elements (DEB-D/O/V). The outlet orifice should be closed by means of protective plug (WOERNER-purchase-no. 914.700-04).

For metering element functional scheme see back page, please!

Order designation:

Metering element

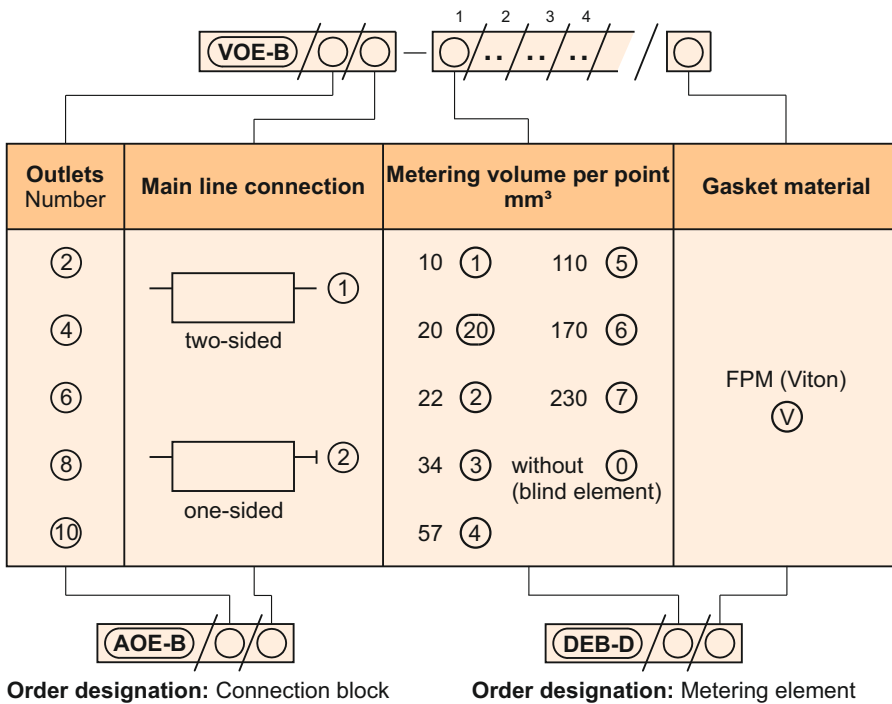
Order example:

 OL-One-line distributor VOE-B with 4 outlets, main line connections one-sided, metering volumes of 22, 57, 110, 230 mm³, gasket material FPM.

Order designation:
VOE-B/4/2-2/4/5/7/V
Order designation:
DEB-D/5/V
Order designation:
DEB-D/0/V

- Subject to modifications -

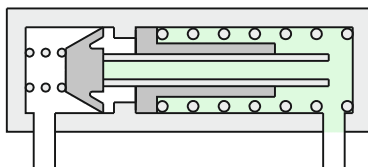
Functional scheme:

Idle position

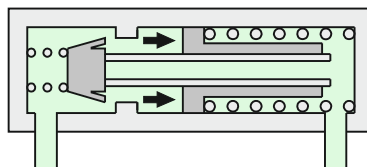

Lubricant delivery and pressure build-up. Metered lubricant volume is allocated.

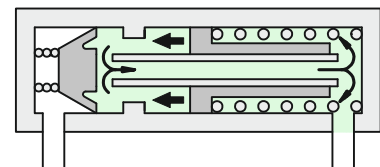

Pressure relief at inlet. Lubricant in metering element is rearranged.

Technical documents also valid for this product:

E0152 EN Spare parts



Important information about this data sheet

Reproduction, also in extracts, only permitted with the approval of the firm of EUGEN WOERNER GmbH & Co. KG.

All the information in this data sheet has been examined for correctness with great care. Nevertheless, WOERNER cannot assume any liability for losses or damage resulting directly or indirectly from the application of the information contained in this data sheet.

All products from WOERNER may only be used as intended and corresponding to the information in this data sheet.

For products supplied with operating instructions, the additional directives and information contained in them are to be complied with.

Materials deviating from those mentioned in this data sheet and the technical documents which further apply may only be poured into and processed in the appliances and systems manufactured and supplied by WOERNER by following agreement with and written approval by WOERNER.

The safety and danger information stated in the safety data sheets of the substances used must be taken into account at all costs.

Transportation of gases, liquefied gases, gases under pressure, vapours and liquids, the vapour pressure of which is more than 0,5 bar above normal atmospheric pressure (1013 mbar) at the maximum admissible temperature, of easy inflammable or explosive media as well as transportation of foodstuffs is forbidden.

Information on EU Directive 2011/95/EU (RoHS)

In its controls and switching devices, WOERNER only uses materials which fulfil the criteria of EU Directive 2011/95/EU. To the extent that hexavalent chromium has been used as corrosion protection in the parts which we produce ourselves, it has already been replaced by other environmentally tolerable protective measures.

The mechanical devices supplied by WOERNER are not affected by EU Directive 2011/95/EU.

But as WOERNER is conscious of its responsibility towards the environment, we shall also use materials fulfilling the requirements of the Directive for devices not covered by EU Directive 2011/95/EU as soon as they are generally available and their use is technically possible.