

### INDICATOR CENTERING HOLDER

- Center cylinders or holes on machine tools
- Can be used with dial test indicators or dial indicators

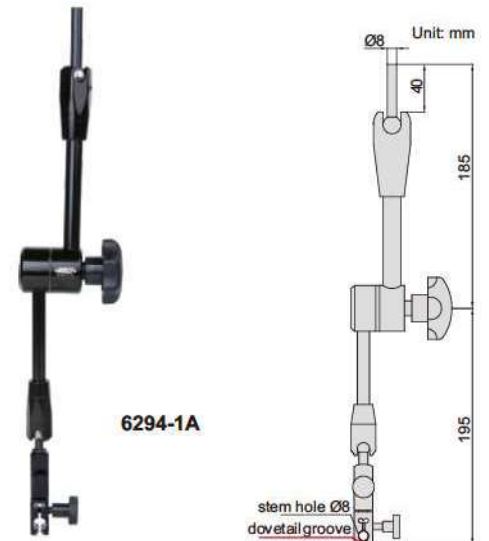

**Code**  
**6294-1A**



### 3D ELECTRONIC EDGE FINDERS

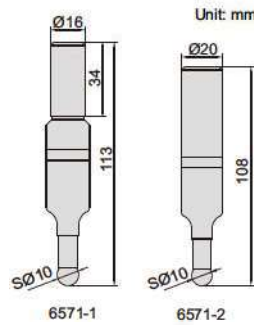
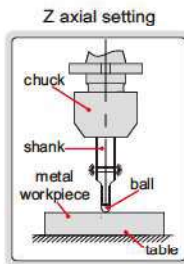
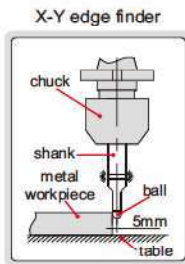
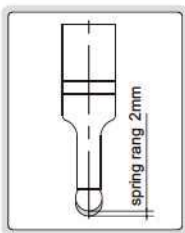

Code	Shank	Contact ball	Accuracy	Battery
6571-1	Ø16mm	SØ10mm	10µm	A23S, 12Vx1 pc
6571-2	Ø20mm	SØ10mm	10µm	A23S, 12Vx1 pc

- The shank is electrically conducted to the metal workpiece through the chuck and table, the LED lights up, when the ball touches the workpiece
- Not suitable for rotary use
- Hardened contact ball

### ELECTRONIC EDGE FINDERS

- The shank is electrically conducted to the metal workpiece through the chuck and table, the LED lights up and the beeper sounds (only for 6566-3), when the ball touches the workpiece
- Not suitable for rotary use
- Hardened shank and contact ball

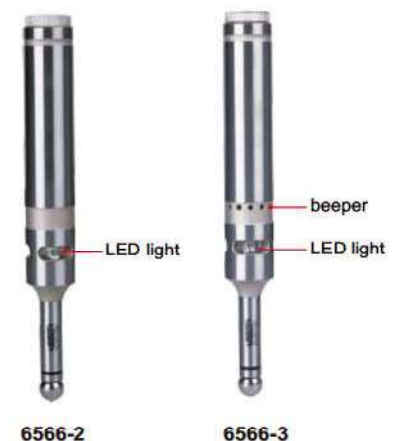
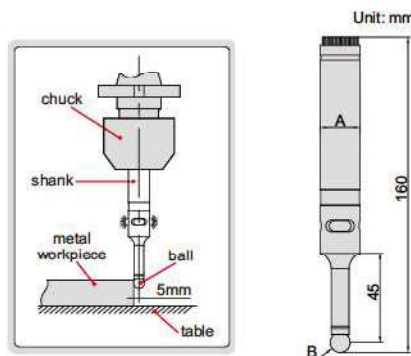

Code	Shank (A)	Contact ball (B)	Accuracy	Beeper	Battery
6566-2	Ø20mm	SØ10mm	5µm	without	23AE, 12Vx1pc
6566-3	Ø20mm	SØ10mm	5µm	with	23AE, 12Vx1pc