

Höhenverstellbare und rollbare Maschinen-Stützfüße!



FSR/600/3



FSR/600/1



FSR/RF/600/3

Maschinen-Transportfahrzeuge und Hebegeräte finden Sie ab der Katalog-Seite T 32.

Räder:

- ▶ Aus Polyamid 6 mit Gleitlager
- ▶ Bruchsicher bei hoher Belastung, geringer Rollwiderstand

Gehäuse:

- ▶ Gehäuseteil aus Aluminium, pulverbeschichtet (Elfenbein)
- ▶ Befestigungselemente aus C45
- ▶ Feststellfuß aus Aluminium/Gummi
- ▶ Mit Nivellierspindel für die Höhenverstellung

Feststell-Rollen

Serie FSR, FSR/RF

Ident-Nr.	Bestell-Nr.	Bauhöhe fest					mm	mm	mm	mm	Rückenloch-Ø	kg
		mm	mm	mm	mm	mm						
Lenkrollen												
0016572	FSR/050/1	42	18	71	81	50	-	-	-	IGM8x12	40	
0016578	FSR/300/1	50	25	83	95	60	-	-	-	IGM12x15	200	
0016579	FSR/300/3	50	22	83	95	60	73 x 73	58 x 58	6,5	-	200	
0016580	FSR/600/1	63	33	102	117	83,5	-	-	-	IGM12x15	400	
0016581	FSR/600/3	63	29	102	117	83,5	90 x 90	70 x 70	9	-	400	
Lenkrollen mit Radfeststeller												
0029635	FSR/RF/600/3	60	55	90	-	25	90 x 90	70 x 70	9,5	-	800	



FSR/1800/3



FSR/RF/800/3



FSR/RF/1000/3



FSR/1300/3



FSR/1300/1

Feststell-Rollen

Serie FSR, FSR/RF

Ident-Nr.	Bestell-Nr.	Bauhöhe fest			mm	mm	mm	mm	mm	mm	Rückenloch-Ø	kg
		mm	mm	mm								
Lenkrollen												
0016573	FSR/1000/1	72	34	120	138	90	-	-	-	IGM16x16	700	
0016574	FSR/1000/3	72	31	120	138	90	95 x 95	70 x 70	11	-	700	
0016575	FSR/1300/1	72	34	121	139	89,5	-	-	-	IGM16x16	900	
0016576	FSR/1300/3	72	31	121	139	89,5	95 x 95	70 x 70	11	-	900	
0016577	FSR/1800/3	92	54	130	155	115	100 x 100	70 x 70	13	-	1200	
Lenkrollen mit Radfeststeller												
0029636	FSR/RF/800/3	75	55	108	-	25	90x90	70x70	9,5	-	1000	
0029637	FSR/RF/1000/3	75	55	110	160	65,5	95x95	70x70	9,5	-	1000	

Räder:

- ▶ Aus Polyamid 6 mit Gleitlager
- ▶ Bruchsicher bei hoher Belastung, geringer Rollwiderstand

Gehäuse:

- ▶ Gehäuseteil aus **Guss**
- ▶ Befestigungselemente aus C45
- ▶ Feststellfuß aus **Stahl/Kunststoff**
- ▶ Mit Nivellierspindel für die Höhenverstellung



SIGERIST

CARL SIGERIST AG CH-8207 Schaffhausen Ebnatstrasse 162 www.sigerist.ch
Phone 0041 52 644 34 30 Fax 0041 52 644 34 01

CARL SIGERIST AG **TECHNICAL INNOVATIONS SINCE 1867**



METALIKA
Locking systems **KACIN**
www.metalika-kacin.com

Rolling Machine Foot

No backlash - integrated guidable caster

Innovative design:

Position STAND

- no backlash, swiveling foot
- good vibration damping

Position ROLLING

- precise positioning through tie-rod

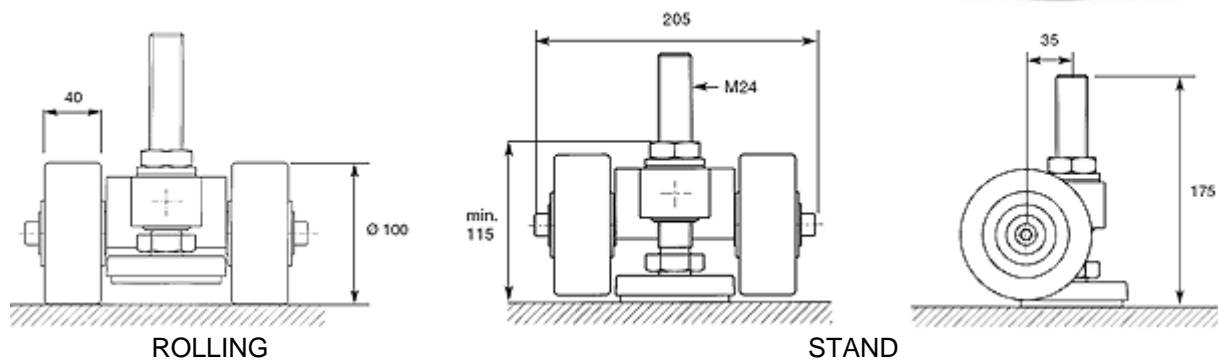

Typ	 kg	Turning Radius R mm	Price €	Price \$
SPR-500 (Polyamid-wheels, with ball bearing)	500	120	208.00	270.00

Discount:
 above USD 1500.--/ EURO 1000.-- 10%

Rolling Machine Foot, Light Type

no backlash

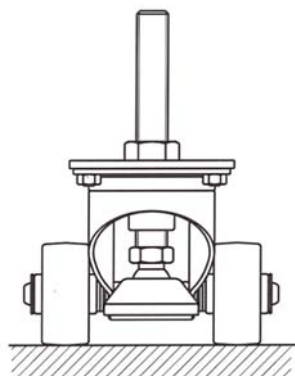

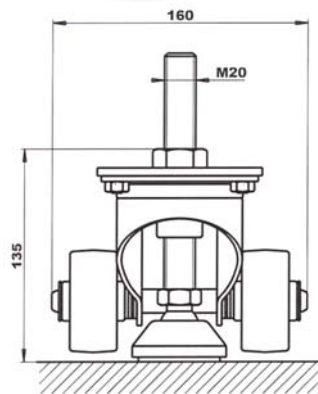

Position ROLLING

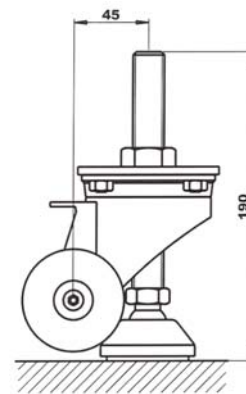

Position STAND

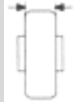

Position STAND

 mm	 mm	Turning Radius R mm	 kg	Type	Price €	Price \$
65	30	105	200	SRP-200	108.00	140.00

Discount:
 above USD 1500.--/ EURO 1000.-- 10%





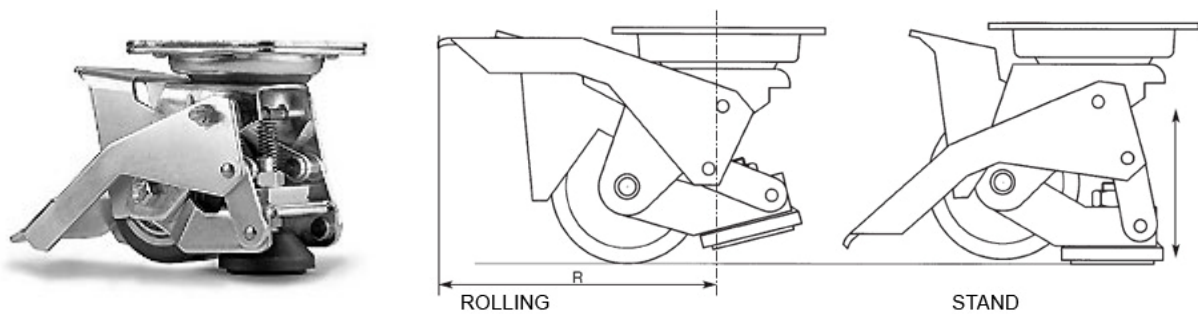

Levelling Caster Standard

Levelling Caster with adjustable mount

The force necessary to service the levers doesn't depend on the weight of the load.

- SLK = Wheel Polyamid
- SLP = Wheel Polyurethane with ball bearings
- SLKX = Wheel Polyamid, housing and caster in stainless



 mm	 mm	 mm	 mm	 mm	 mm	turning radius R mm	 kg	Type	Price €	Price \$
80	25	105x85	80x60	9	117-123	150	150	SLP 01/80	77.00	100.00
75	40	105x85	80x60	9	115-123	150	300	SLP 01/75	110.00	143.00
125	50	135x110	105x80	13	171-181	190	450	SLP 1/125	146.00	190.00
65	30	105x85	80x60	9	110-118	150	100	SLK 01/65	62.00	80.00
80	30	105x85	80x60	9	117-123	150	200	SLK 01/80	69.00	90.00
75	40	105x85	80x60	9	115-123	150	300	SLK 01/75	107.00	139.00
125	50	135x110	105x80	13	175-181	190	450	SLK 1/125	139.00	180.00
125	50	140x110	105x80	13	160-176	190	400	SLKX 1/125	280.00	480.00

Discount:
 above USD 1500.--/ EURO 1000.-- 10%

Levelling Caster Light Execution







Levelling Caster with adjustable mount

- in the position levelling, the housing is free of load and can be turned
- good manoeuvrability thanks to the long distance between the wheels
- wheels nylon with plain bore
- Levelling foot reinforced polyamide diameter 40 mm with NBR rubber pad
- length of the wheel shaft: 100 mm



ROLLING

STAND

 mm	 mm	 mm	 mm	 mm	turning radius mm	 kg	Type	Price €	Price \$
40	2 x 15	M 10	20	65-69	60	100	SLK 41/40	39.00	50.00

Discount:
 above USD 1500.--/ EURO 1000.-- 10%

Levelling Caster Stainless

Levelling Caster with adjustable mount







- good manoeuvrability thanks to the long distance between the wheels
- wheels nylon with plain bore
- Levelling foot polyamid diameter 40 mm with NBR rubber pad
- height adjusting range (foot operated): 8 mm, by turning the caster around the mount
- ground clearance of the mount: 5 mm, can be improved up to 20 mm by swivelling the mount
- sizes overall: length 140 mm, width 100 mm



ROLLING



STAND

 mm	 mm	 mm	 mm	 mm	turning radius mm	 kg	Type	Price €	Price \$
50	2 x 15	M 10	20	ROLLING 77 LEVELLING 77-85	80	100	SLKX 5/50	240.00	310.00

Discount:
 above USD 1500.--/ EURO 1000.-- 10%

Levelling Caster System Synchro-Lift

By handling one pedal, 4 levelling elements relieve the wheels at the same time.

- distance between the levelling casters can be chosen individually
- to handle the system, only 2 levelling casters must be accessible
- very good manoeuvrability thank to the side position of the wheels
- max. charge 200 kg/levelling-caster (800 kg/system)
- height 180 mm
- turning radius 120 mm
- wheels (diameter 100 mm) PU or polyamid
- length of the axe 160mm
- the levelling elements can be adjusted individually, lifting height 10 mm
- distance between the fixing wholes on the plate 80 x 60 mm (for screws M8)
- the system can be used for 2 or 4 levelling casters

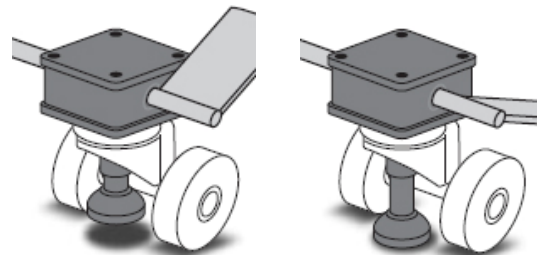

ROLLING

STAND

Price:









size 2x1 m

€ 1850.00 net/system

\$ 2400.00 net/system

Caster for heavy loads and low eight



 mm	 mm	 mm	 mm	 mm	 mm	 mm	 kg	Type	Price €	Price \$
50	2x25	90x90	70x70	9.5	85	25	800	ACMT-600F	47.00	60.00

Discount:
 above USD 1500.--/ EURO 1000.-- 10%

Screwless Shaft-Hub Connection

- stainless steel 1.4301 (A2)
- minimal space requirement
- fast and easy mounting

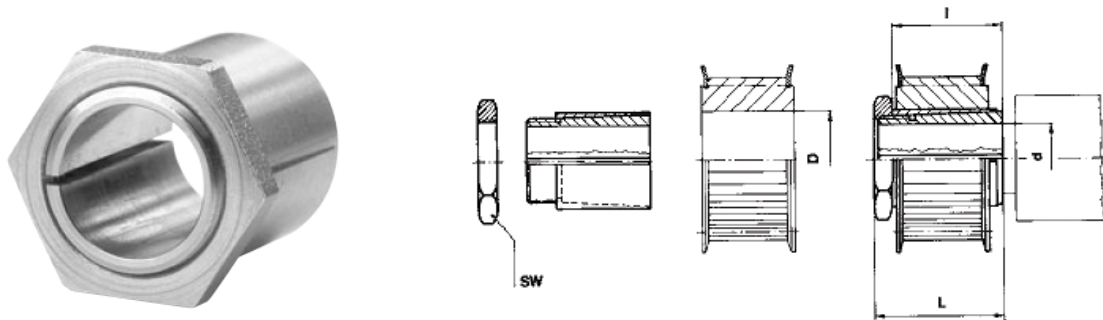

Type	d +/- 0,01	D-0,03	L	I	thread	SW	M (Nm)	tightrening torque	Price €	Price \$
SZ-5,00	5	10	15	12,5	M8x0,5	10	4	5	11.00	16.00
SZ-6,00	6	10	15	12,5	M8x0,5	10	7	8	11.00	16.00
SZ-6,35	6,35	10	15	12,5	M8x0,5	10	7	8	11.00	16.00
SZ-8,00	8	14	22	19	M12x1	16	14	15	13.00	16.00
SZ-9,00	9	14	22	19	M12x1	16	14	15	13.00	16.00
SZ-10,00	10	17	22	18,5	M15x1	18	18	19	17.00	16.00
SZ-11,00	11	17	22	18,5	M15x1	18	18	19	17.00	16.00
SZ-12,00	12	17	22	18,5	M15x1	18	18	19	17.00	16.00
SZ-14,00	14	20	28	23	M17x1	20	24	25	17.00	22.00
SZ-15,00	15	20	28	23	M17x1	20	24	25	20.00	22.00

Discount:
 above USD 1500.--/ EURO 1000.-- 10%