



## Electronic Flow Monitor for liquids



measuring  
•  
monitoring  
•  
analysing



### KAL-K



- Range: approx. 4 - 200 cm/s
- $p_{\max}$ : 100 bar
- Temperature of medium: -20 ... +80 °C  
Option: 0 ... +120 °C
- Process connection:  
G 1/4, G 1/2, G 3/4  
M12x1, 1/4" NPT, 1/2" NPT, 3/4" NPT  
Tri-Clamp®
- Material sensor:  
1.4305; 1.4301; 1.4404; 1.4571
- Intelligent temperature compensation
- No moving parts
- Minimal pressure loss



SS

KOBOLD companies worldwide:

ARGENTINA, AUSTRALIA, AUSTRIA, BELGIUM, BULGARIA, CANADA, CHILE, CHINA, COLOMBIA, CZECHIA, EGYPT, FRANCE, GERMANY, GREAT BRITAIN, HUNGARY, INDIA, INDONESIA, ITALY, MALAYSIA, MEXICO, NETHERLANDS, PERU, POLAND, REPUBLIC OF KOREA, ROMANIA, SINGAPORE, SPAIN, SWITZERLAND, TAIWAN, THAILAND, TUNISIA, TURKEY, USA, VIETNAM

KOBOLD Messring GmbH  
Nordring 22-24  
D-65719 Hofheim/Ts.  
Head Office:  
+49(0)6192 299-0  
+49(0)6192 23398  
info.de@kobold.com  
www.kobold.com



**Method of operation**

The model KAL-... electronic flow monitor continuously monitors liquid media. It is suited for securely monitoring flows with minimum pressure loss. Sensitivity to soiling is significantly reduced by means of a single-part sensor.

**Theory of operation**

The operation of the model KAL-... electronic flow monitor is based on the calorimetric principle. The end face of the sensor is heated to a few degrees above the temperature of the flow medium. When the medium flows, the heat generated in the sensor is transferred to the medium, ie, the sensor is cooled. The cooling procedure is an accurate measure of the flow velocity.

The sensor signal is compared with the reference data stored in a microcontroller. An alarm signal and/or an analogue signal (4-20mA) that is proportional to the flow velocity is output if the actual flow velocity deviates from the desired flow velocity. The microcontroller allows the flow indicator to be easily calibrated and the temperature to be compensated.

**Features**

- Optimal temperature compensation
- Intelligent switching
- Measuring range adjustment
- No moving parts
- Easy to install and commission
- Minimal pressure loss
- Easy to use

**Measuring /switching ranges**

NW [mm]	approx. measuring range l/min water	NW [mm]	approx. measuring range l/min water
8	0.12 - 6.0	40	3.0 - 150
10	0.19 - 9.4	50	4.7 - 235
15	0.42 - 21.8	60	6.8 - 340
20	0.75 - 37.7	80	12.0 - 603
25	1.18 - 59.0	100	18.8 - 942
30	1.7 - 84.8	150	42.4 - 2120

**Important:** The flow velocity has been converted for the nominal pipe size for the specified measuring ranges. Please note that the flow velocity approaches zero in the pipeline in the direction of the wall. Depending on the nominal pipe size, depth of engagement of the sensor, and flow profile, the deviations from the specified flow rates can be of considerable magnitude.

**Temperature compensation**

The temperature of the KOBOLD flow monitor is compensated with a microcontroller. All data required for temperature compensation are stored in EEPROMS, and are maintained for at least 10 years after power failure. The instruments may be easily adjusted by the customer to suit process conditions.

The measured flow rate is compared with the zero-point adjustment values stored in the EEPROM and the stored characteristic curves. The data is processed by the microcontroller and controls the alarm signal or the analogue output.

The sensor switch point is absolutely consistent, as the sensor has been adapted to suit the process data.

**Drift of the switch point by temperature influence**

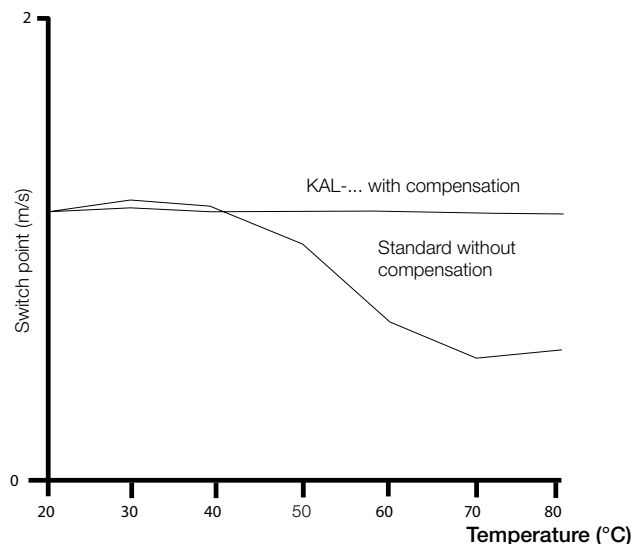

**Range of models**

**Compact devices**

- KAL-A... Flow meter with analogue output (4-20 mA)
- KAL-AK Flow meter /-monitor with analogue output (4-20 mA) and alarm signal (PNP/NPN, N/O contact)
- KAL-K... Flow indicator alarm signal (PNP/NPN, N/O contact)

**Separate version**

- KAL-... Sensor
- KAL-E1... Electronics with relay contact for flow monitoring
- KAL-E2... Electronics with relay contact and trend display for flow monitoring
- KAL-E3... Electronics with relay contact for flow and temperature monitoring trend display for flow monitoring



**Technical Details (electronics)**

Case material: glass-fibre-reinforced polyamide  
 Sensor material: Stainless steel (see order details)  
 Power supply: 24 V<sub>DC</sub> ±10%,  
 110 V<sub>DC</sub> ±30%,  
 110, 230 V<sub>AC</sub> -20/+10%,  
 Power input: max. 4.5 W (typically 1,2 W)  
 max. 3.6 W für 24 V<sub>DC</sub>  
 Ambient temperature: -20°C ... +60°C  
 Medium temperature: -20°C ... +80°C (standard version)  
 0°C ... +120°C (high temp. version)  
 CIP compatibility: max. 140°C non-operating  
 Max. pressure: 100 bar  
 Warm up time: max. 12 s  
 Switching range: approx. 4 cm/s to 200 cm/s  
 Temperature gradient: unlimited  
 Response time: 5.6 ... 12 s typically  
 on request: 2- 5.6 s (KAL-KS...)  
 Flow rate indication: trend display with 8-digit LED chain  
 Switch point adjustm.: with potentiometer, optical indication  
 on LED chain with flashing LED  
 Output indicator: LED, red = alarm,  
 green = flow OK  
 Electr. connection: cable gland M16x1.5; connector  
 M12x1 (only 24 V<sub>DC</sub> version)  
 circular connector 3/8" with socket  
 (230/115 V-versions) or  
 connector M12x1 with socket and  
 2 m cable, 24 V<sub>DC</sub> version

Switch output:  
 24 V<sub>DC</sub> version: semiconductor, PNP/NPN  
 switchable, max. 400 mA,  
 short-circuit proof  
 relay max. 0,2 A /110 V<sub>DC</sub>  
 110 V<sub>DC</sub> version: relay max. 5 A  
 110 V<sub>AC</sub>, 230 V<sub>AC</sub> version: actual value ≥ setpoint value;  
 (standard setting: green LED  
 is energized) output switched  
 available as option  
 N/O function:  
 N/C function:  
 Protection: IP65



**Order Details (Example: KAL-K1215 S PG 3)**

Version	Connection	Material stainless steel / version					Type of contact	Electr. connection	Power supply
		1.4301		1.4305	1.4571				
		Standard Version	Extended version	Standard Version	Standard Version	Extended version			
Standard Version (-20...+80°C)	G 1/4	KAL-K1308	-	-	KAL-K1408 <sup>1)</sup>	-	S = N/O contact O = N/C contact	PG = Cable gland M16x1.5 ST = connector M12x1 <sup>2)</sup> SK = Circular connector with socket	0 = 230 V <sub>AC</sub> 1 = 110 V <sub>AC</sub> 3 = 24 V <sub>DC</sub> 6 = 110 V <sub>DC</sub>
	G 1/2	KAL-K1315	KAL-K6315	KAL-K1215	KAL-K1415	KAL-K6415			
	G 3/4	KAL-K1320	KAL-K6320	-	KAL-K1420 <sup>1)</sup>	KAL-K6420 <sup>1)</sup>			
	M 12x1	KAL-K0312	-	-	-	-			
	1/4" NPT	KAL-K5308	KAL-K8308	-	KAL-K5408 <sup>1)</sup>	KAL-K8408 <sup>1)</sup>			
	1/2" NPT	KAL-K5315	KAL-K8315	-	KAL-K5415	KAL-K8415			
	3/4" NPT	KAL-K5320	KAL-K8320	-	KAL-K5420 <sup>1)</sup>	KAL-K8420 <sup>1)</sup>			
Tri-Clamp®, DIN 32676	-	-	-	KAL-K4440 <sup>3)</sup>	-				
Version for high temperature (0...+120°C)	G 1/4	KAL-KH1308	KAL-KH6308	-	KAL-KH1408 <sup>1)</sup>	KAL-KH6408 <sup>1)</sup>	S = N/O contact O = N/C contact	PG = Cable gland M16x1.5 ST = connector M12x1 <sup>2)</sup> SK = Circular connector with socket	0 = 230 V <sub>AC</sub> 1 = 110 V <sub>AC</sub> 3 = 24 V <sub>DC</sub> 6 = 110 V <sub>DC</sub>
	G 1/2	KAL-KH1315	KAL-KH6315	KAL-KH1215	KAL-KH1415	KAL-KH6415			
	G 3/4	KAL-KH1320	KAL-KH6320	-	KAL-KH1420 <sup>1)</sup>	KAL-KH6420 <sup>1)</sup>			
	M 12x1	KAL-KH0312	-	-	-	-			
	1/4" NPT	KAL-KH5308	KAL-KH8308	-	KAL-KH5408 <sup>1)</sup>	KAL-KH8408 <sup>1)</sup>			
	1/2" NPT	KAL-KH5315	KAL-KH8315	-	KAL-KH5415	KAL-KH8415			
	3/4" NPT	KAL-KH5320	KAL-KH8320	-	KAL-KH5420 <sup>1)</sup>	KAL-KH8420 <sup>1)</sup>			
Tri-Clamp®, DIN 32676	-	-	-	KAL-KH4440 <sup>3)</sup>	-				

<sup>1)</sup> Stainless steel hexagon 1.4301    <sup>2)</sup> for 24 V<sub>DC</sub> only    <sup>3)</sup> Stainless steel 1.4404

Please specify sensor length dimension C for extended version



## Electronic Flow Monitor - Separate Version Model KAL-E(H)

### Technical Details (sensor)

Material:	case: see order details cable: PVC option (KAL-...HT): silicone cable gland: brass nickel-plated, Pg 7
Cable:	2 x 0,56 mm <sup>2</sup> , length = 2 m max. line length 100 m
Switching range:	4 cm/s ... 200 cm/s
Temperature of medium:	-20 °C ... +80 °C, option (KAL-...HT): 0 °C ... +120 °C
Ambient temperature:	-20 °C ... +80 °C, KAL-...HT: 0 °C ... +120 °C
Max. Pressure:	100 bar (KAL-1132 and KAL-1140: 25bar)
Protection:	IP 68
Approval:	ATEX: $\text{Ex}$ II 1G Ex ia IIB T4 Ga IECEX: Ex ia IIB T4 Ga

**Important!** For cable lengths >10 m, the client can increase the absolute switching accuracy manually by adjustment (cable resistance must be considered).

### Electronics Model KAL-E(H)..

Power input:	max. 3.6 W
Switch capacity:	max. 250 V, max. 3 A
Switch point adjustm.:	with Potentiometer
Switching function:	changeover, on rising flow (terminals 9 +10 closed)
Option (KAL-E3..):	changeover, on rising temperature below setpoint, LED is energized (terminals 12 + 13 closed)
Output:	changeover relay
Output indicator:	with LED
Warm up time:	max. 12 s
Temperature range:	-20 ... +80 °C
Accuracy:	temperature limit value $\pm 2\%$
Repeatability:	approx. 2%
Response time:	5 ... 12 s (typically)
DIN rail fitting:	DIN EN 50022 and DIN 46277
Protection:	case: IP 40, terminals: IP 20
Case:	polycarbonate, L75 x W 55 x H 110 mm
Sensor output:	short-circuit proof, cable break is detected as flow stoppage
Power failure:	calibration data are store without battery for 10 years
Approval:	ATEX: $\text{Ex}$ II (1)G [Ex ia Ga] IIB IECEX: [Ex ia Ga] IIB

### Order Details sensor (example: KAL-1308 HT)

	Connection	Order numbers				Electrical connection/ version
		Sensor with insertion fitting		Sensor with inline fitting		
		1.4301	1.4571	Fitting brass/ Sensor 1.4301	Fitting 1.4301/ Sensor 1.4301	
G ¼	KAL-1308	KAL-1408	KAL-1108	KAL-1208	00 = 2 m PVC cable HT = 2 m Silicone cable  YP = PVC cable/ special length YS = Silicone cable/ special length YY = Special cable/ special length  Ex = Ex sensor, PVC cable Ex ia IIB T4 Ga (specify cable length)	
G ¾	-	-	KAL-1110	KAL-1210		
G ½	KAL-1315	KAL-1415	KAL-1115	KAL-1215		
G ¾	KAL-1320	KAL-1420	KAL-1120	KAL-1220		
G 1	-	-	KAL-1125	KAL-1225		
G 1 ¼	-	-	KAL-1132	KAL-1232		
G 1 ½	-	-	KAL-1140	KAL-1240		
M 12 x 1	KAL-0312	-	-	-		
¼" NPT	KAL-5308	KAL-5408	KAL-5108	KAL-5208		
¾" NPT	-	-	KAL-5110	KAL-5210		
½" NPT	KAL-5315	KAL-5415	KAL-5115	KAL-5215		
¾" NPT	KAL-5320	KAL-5420	KAL-5120	KAL-5220		

### Order Details electronics (example: KAL-E10 (standard) or KAL-EH10 (version for high temperature))

	Field of application	Flow trend display	Temperature monitoring	Supply voltage			
				24 V <sub>DC</sub>	24 V <sub>AC</sub>	110 V <sub>AC</sub>	230 V <sub>AC</sub>
Flow	-	-	-	KAL-E13	KAL-E12	KAL-E11	KAL-E10
				KAL-EH13	KAL-EH12	KAL-EH11	KAL-EH10
Flow	8-LEDs	-	-	KAL-E23	KAL-E22	KAL-E21	KAL-E20
				KAL-EH23	KAL-EH22	KAL-EH21	KAL-EH20
Flow/ Temperature	8-LEDs	-	-20 ... +80 °C	KAL-E33	KAL-E32	KAL-E31	KAL-E30
			0 ... +120 °C	KAL-EH33	KAL-EH32	KAL-EH31	KAL-EH30
[Ex ia Ga] IIB	Flow/ Temperature	8-LEDs	-20 ... +80 °C	-	KAL-E32Ex	-	KAL-E30Ex

**Technical Details**









Case material:	glass-fibre-reinforced polyamide
Sensor material:	stainless steel (see order details)
Power supply:	24 V <sub>DC</sub> ±20%
Power input:	max. 3,6 W (typically 1,2 W)
Ambient temperature:	-20 °C ... +60 °C
Temperature of medium:	-20 °C ... +80 °C
Max. Pressure:	100 bar
Warm up time:	max.12 s
Measuring range:	approx. 4 cm/s to 200 cm/s
Temperature gradient:	unlimited
Response time:	5.6 ... 12 s
Accuracy:	±10% of full scale
Repeatability:	±1% of full scale
Signal output:	4-20 mA
Flow rate indication:	trend display with 8-digit LED chain
Protection:	IP 65



**For KAL-AK... only**

Switching function:	N/O contact
Switch point adjustment:	with potentiometer, optical indication on LED chain with flashing LED
Output indicator:	LED, red = alarm, green = flow OK
Switching output:	semiconductor, PNP/NPN switchable, max. 400 mA, short-circuit proof

**Electrical connection**

KAL-A...		KAL-AK...			
4		4...20 mA	4		4...20 mA
3		+24 V <sub>DC</sub>	3		+24 V <sub>DC</sub>
2		Ground	2		Ground
1			1		PNP/NPN-Switch

**Order Details** (example: KAL-A1308A4 PG)

Output/contact	Connection	Order numbers for materials			Electr. connection
		1.4301	1.4305	1.4404	
4-20 mA/ without contact	G ¼	KAL-A1308A4	-	KAL-A1408A4 <sup>1)</sup>	PG = cable gland M16x1,5 ST = connector M12x1
	G ½	KAL-A1315A4	KAL-A1215A4	KAL-A1415A4	
	G ¾	KAL-A1320A4	-	KAL-A1420A4 <sup>1)</sup>	
	M 12 x 1	KAL-A0312A4	-	-	
	¼" NPT	KAL-A5308A4	-	KAL-A5408A4 <sup>1)</sup>	
	½" NPT	KAL-A5315A4	-	KAL-A5415A4	
	¾" NPT	KAL-A5320A4	-	KAL-A5420A4 <sup>1)</sup>	
	Tri-Clamp®, DIN 32676	-	-	KAL-A4440A4 <sup>2)</sup>	
4-20 mA/ N/O contact NPN/PNP switchable	G ¼	KAL-AK1308AS	-	KAL-AK1408AS <sup>1)</sup>	PG = cable gland M16x1,5 ST = connector M12x1
	G ½	KAL-AK1315AS	KAL-AK1215AS	KAL-AK1415AS	
	G ¾	KAL-AK1320AS	-	KAL-AK1420AS <sup>1)</sup>	
	M 12 x 1	KAL-AK0312AS	-	-	
	¼" NPT	KAL-AK5308AS	-	KAL-AK5408AS <sup>1)</sup>	
	½" NPT	KAL-AK5315AS	-	KAL-AK5415AS	
	¾" NPT	KAL-AK5320AS	-	KAL-AK5420AS <sup>1)</sup>	
	Tri-Clamp®, DIN 32676	-	-	KAL-AK4440AS <sup>2)</sup>	

<sup>1)</sup>Stainless steel hexagon 1.4301    <sup>2)</sup>Stainless steel 1.4404



Dimensions

KAL-K..., KAL-A(K)...

A	C [mm]	E [mm]	F [mm]	G [mm]
G ¼	26	7	-	-
G ½	40	9	-	-
G ¾	43	12	-	-
M12 x 1	23	6	-	-
¼" NPT	-	6	10	26
½" NPT	-	18.5	15	43
¾" NPT	-	18	15	39

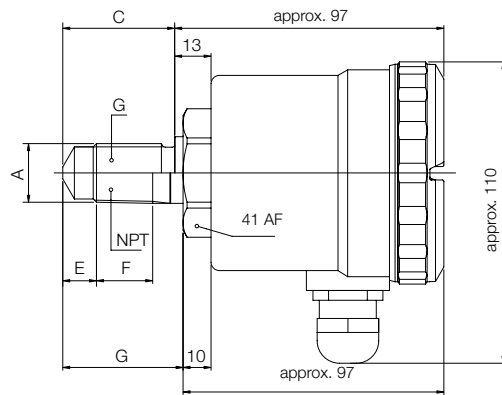

KAL-... Sensor

A	B	C [mm]	D [mm]
M12 x 1	19 AF	23	43
G ¼	19 AF	26	43
G ½	27 AF	43	58
G ¾	32 AF	43	58

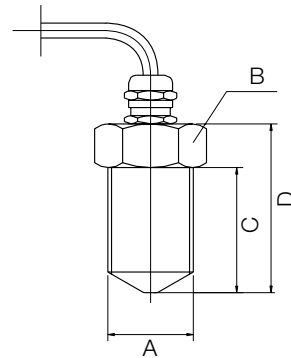

KAL-... with pipe fitting

A	B	C [mm]	D [mm]	E [mm]
G ¼	27 AF	10	50	81
G ⅜	27 AF	10	50	81
G ½	27 AF	10	50	81
G ¾	32 AF	15	52	82.5
G 1	39 AF	15	56	85
G 1 ¼	46 AF	15	50	90
G 1 ½	55 AF	15	50	92.5

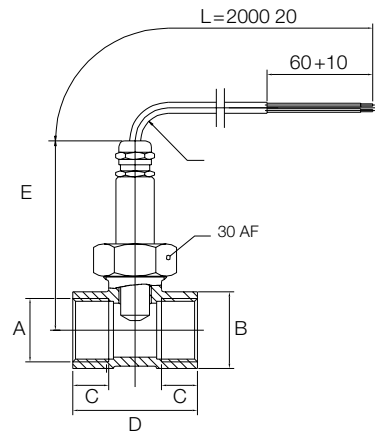

KAL-...4440 with Tri-Clamp®

Counterpart according to DIN 32676 for NW 32/NW40

