

# Ultra-compact EMC/RFI Filter for Motor Drives Applications



- New: solid safety connector blocks available for the whole range
- Exceptional attenuation performance from 150 kHz to 30 MHz
- Excellent saturation resistance up to 50 m cable length
- Most compact and slim filter design in its class



### Performance indicators

Attenuation performance



Rated current [A]

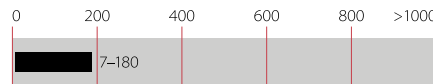

## Technical specifications

<b>Maximum continuous operating voltage</b>	3x 480/277 VAC (FN 3258) 3x 520/300 VAC (FN 3258 H)
<b>Operating frequency</b>	dc to 60 Hz
<b>Rated currents</b>	7 to 180 A @ 50°C
<b>High potential test voltage</b>	P → E 2650 VDC for 2 sec P → P 2100 VDC for 2 sec
<b>Protection category</b>	IP 20
<b>Overload capability</b>	1.5x rated current for 1 minute, once per hour 4x rated current at switch on,
<b>Temperature range (operation and storage)</b>	-25°C to +100°C (25/100/21)
<b>Flammability corresponding to</b>	UL 94 V-2 or better
<b>Design corresponding to</b>	UL 1283, CSA 22.2 No. 8 1986, IEC/EN 60939
<b>MTBF @ 50°C/400 V (Mil-HB-217F)</b>	300,000 hours

### Approvals



### Features and benefits

- The extremely compact and slim filter design allows a trouble-free installation even where the available mounting space is minimal
- With new additional filter types providing safety terminal blocks, the most preferred connection style can be chosen fast and easy. This helps to stay in line with the electrical connection concept of a given application
- FN 3258 filters ensure compliance with Class A limits according to EN 55011 up to 50 m cable length and beyond. Further they can contribute significantly to meet conducted emission limits according to Class B
- Filter operation on the mains input side of consumers increases their reliability and conducted immunity significant
- Chokes with exceptional saturation resistance and excellent thermal behavior are a vital part of FN 3258 design. Thus, all filters retain the expected filter performance even in very noisy applications and under full load conditions

### Typical applications

- Three-phase variable speed motor drives, servo drives, inverters and converters
- Applications comprising energy conversion devices like machines or process automation equipment
- HVAC equipment, elevators, power supplies, UPS and further three-phase applications

### Typical electrical schematic

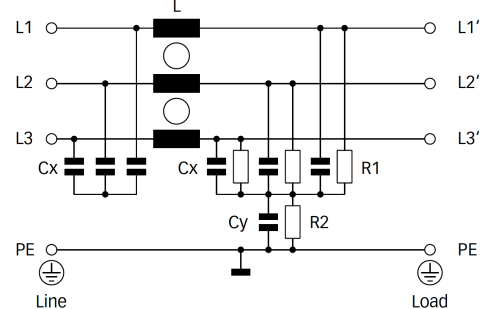

### Filter selection table

Filter	Rated current @ 50°C (40°C) [A]	Typical drive power rating* [kW]	Leakage current** @ 400 VAC/50 Hz [mA]	Power loss @ 25°C/50 Hz [W]	Input/Output connections 	Weight [kg]
<b>FN 3258-7-44</b>	7 (7.7)	4	33.0	3.8	-44	0.5
<b>FN 3258-16-44</b>	16 (17.5)	7.5	33.0	6.1	-44	0.8
<b>FN 3258-30-33</b>	30 (32.9)	15	33.0	11.8	-33	1.2
<b>FN 3258-42-33</b>	42 (46.0)	22	33.0	15.7	-33	1.4
<b>FN 3258-55-34</b>	55 (60.2)	30	33.0	25.9	-34	2.0
<b>FN 3258-75-34</b>	75 (82.2)	37	33.0	32.2	-34	2.7
<b>FN 3258-100-35</b>	100 (109.5)	55	33.0	34.5	-35	4.3
<b>FN 3258-130-35</b>	130 (142.4)	75	33.0	43.1	-35	4.5
<b>FN 3258-180-40</b>	180 (197.1)	90	33.0	58.3	-40	6.0
<b>FN 3258 H-7-44</b>	7 (7.7)	4	33.0	3.8	-44	0.5
<b>FN 3258 H-16-44</b>	16 (17.5)	7.5	33.0	6.1	-44	0.8
<b>FN 3258 H-30-33</b>	30 (32.9)	18.5	33.0	11.8	-33	1.2
<b>FN 3258 H-42-33</b>	42 (46.0)	22	33.0	15.7	-33	1.4
<b>FN 3258 H-55-34</b>	55 (60.2)	37	33.0	25.9	-34	2.0
<b>FN 3258 H-75-34</b>	75 (82.2)	45	33.0	32.2	-34	2.7
<b>FN 3258 H-100-35</b>	100 (109.5)	55	33.0	34.5	-35	4.3
<b>FN 3258 H-130-35</b>	130 (142.4)	75	33.0	43.1	-35	4.5
<b>FN 3258 H-180-40</b>	180 (197.1)	110	33.0	58.3	-40	6.0

\* Calculated at rated current, 440 VAC (FN 3258)/480 VAC (FN 3258 H) and cos phi=0.8. The exact value depends upon the efficiency of the drive, the motor and the entire application.

\*\* Maximum leakage under normal operating conditions. Note: if two phases are interrupted, worst case leakage could reach 5.4 times higher levels.

### Typical filter attenuation

Per CISPR 17; A=50/50 sym; B=50/50 asym; C=0.1/100 sym; D=100/0.1 sym

7 to 42 A types

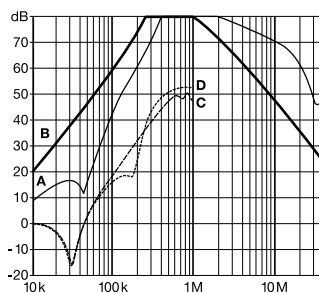

55 to 100 A types

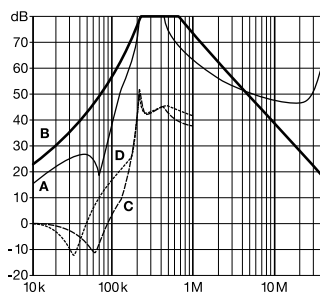

130 and 180 A types

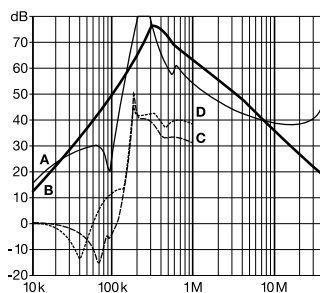

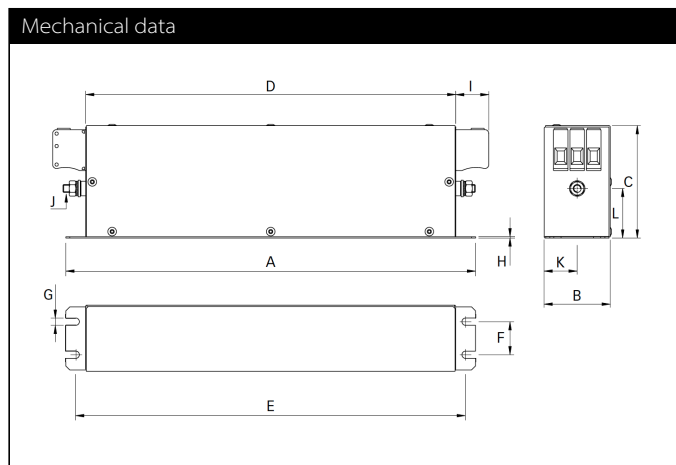

Note: in favour of a better readability, connectors and earth studs are not shown in the horizontal projection.

## Dimensions

	7 A	16 A	30 A	42 A	55 A	75 A	100 A	130 A	180 A
<b>A</b>	190	250	270	310	250	270	270	270	380
<b>B</b>	40	45	50	50	85	80	90	90	120
<b>C</b>	70	70	85	85	90	135	150	150	170
<b>D</b>	160	220	240	280	220	240	240	240	350
<b>E</b>	180	235	255	295	235	255	255	255	365
<b>F</b>	20	25	30	30	60	60	65	65	102
<b>G</b>	4.5	5.4	5.4	5.4	5.4	6.5	6.5	6.5	6.5
<b>H</b>	1	1	1	1	1	1.5	1.5	1.5	1.5
<b>I</b>	22	22	25	25	39	39	45	45	51
<b>J</b>	M5	M5	M5	M6	M6	M6	M10	M10	M10
<b>K</b>	20	22.5	25	25	42.5	40	45	45	60
<b>L2</b>	29.5	29.5	39.5	37.5	26.5	70.5	64	64	47

All dimensions in mm; 1 inch = 25.4 mm

Tolerances according: ISO 2768-m/EN 22768-m

## Filter input/output connector cross sections

	-33	-34	-35	-40	-44
<b>Solid wire</b>	16 mm <sup>2</sup>	35 mm <sup>2</sup>	50 mm <sup>2</sup>	95 mm <sup>2</sup>	10 mm <sup>2</sup>
<b>Flex wire</b>	10 mm <sup>2</sup>	25 mm <sup>2</sup>	50 mm <sup>2</sup>	95 mm <sup>2</sup>	6 mm <sup>2</sup>
<b>AWG type wire</b>	AWG 6	AWG 2	AWG 1/0	AWG 4/0	AWG 8
<b>Recommended torque</b>	1.5-1.8 Nm	4.0-4.5 Nm	7-8 Nm	17-20 Nm	1.5-1.8 Nm

Please visit [www.schaffner.com](http://www.schaffner.com) to find more details on filter connectors.



