

GENERAL
CATALOGUE











2016

AUTOMATION FOR EXTERNAL
CLOSING SYSTEMS, DOORS,
WINDOWS AND SHUTTERS



URMET IS IN YOUR LIFE

CONTENTS

	URMET AND THE GROUP	02-05
	SHOWCASE	06-07
	AUTOMATION KITS	08-27
	SWING GATES	28-53
	SLIDING GATES	54-77
	UP-AD-OVER, SECTIONAL, FOLDING DOORS	78-89
	TRAFFIC BARRIERS	90-101
	CONTROL UNITS AND INDICATORS	102-121
	ROLLING SHUTTERS	122-141
	SIDE-HUNG SHUTTERS	142-145
	WINDOWS AND DOMES	146-163
	SLIDING DOORS	164-193
ADI	HOME AUTOMATION	194-205
i	TECHNICAL INFORMATION	206-231
	SYMBOLS	232-233
	ORDER FORM	234-236
	GENERAL SALES CONDITIONS	234-236



EXTERNAL CLOSING SYSTEM

CODE INDEX

CODE	P.	CODE	P.	CODE	P.	CODE	P.
41005/050	51	41180/061	77	41626/001	69-71		39
41007/051	121	41180/062	77		73		41
41012/001	19-45	41180/063	23-25		106		43
41012/002	20-45		67		109		45
41012/003	21-45		69	41628/001	16-17		47
41012/800	19		71		19		49
41012/802	20		73		20		51
41012/804	21		75		21		53
41013/001	47	41180/064	22-24		37		63
41013/002	47		63		39		65
41013/003	47		65		41		67
41013/004	47		67		45		69
41013/005	47		69		47		71
41013/006	47	41200/005	87		51		73
41020/054	49	41200/050	87		53		75
41026/001	14-37	41200/051	87		110		77
41026/001	14-37	41201/050	87		106		85
41026/800	14	41201/051	85-87	41637/001	77		87
41026/801	14	41201/052	85-87	41700/014	121		89
41026/802	37	41201/055	87	41700/016	51-53		97
41029/001	18-43	41201/056	87		121		99
41029/050	43	41210/001	26-85	41700/800	110		101
41029/053	43	41210/002	26-85	41700/801	49-51		109
41029/054	18-43	41210/054	85		67		110
41029/800	18-43	41210/055	85		69		112
41032/001	16-39	41210/058	26-85		71	41906/001	17
41032/800	16	41210/061	26-85		73	41923/009	37-39
41032/801	16	41210/062	26-85		110		49
41033/001	15-39	41210/067	85	41702/003	37		75
41033/800	15	41210/068	85-87	41703/001	117		77
41033/801	15	41210/069	26-85-87	41703/002	117		85
41035/001	17-41	41210/801	26	41704/002	53	41830/050	119-116
41035/002	17-41	41241/056	27-89	41704/004	53	41830/051	116
41035/800	17	41243/800	27-89	41706/007	112	41830/052	116-119
41035/801	17	41243/810	27-89	41706/009	106	41830/053	119-116
41050/002	51	41243/058	27-89	41800/002	115	41830/054	119-116
41050/003	51	41243/059	27-89	41801/004	117	41830/055	97-99
41050/050	51	41522/001	97-99-101	41801/005	117		41923/051
41051/001	51	41522/002	99-101	41810/002	118		41923/052
41051/002	51	41523/001	101	41810/050	118	41840/006	14-15
41055/001	51	41545/001	97	41811/001	75-77-118		41926/001
41055/003	51	41580/001	99	41811/050	119		41929/001
41056/002	53	41580/002	101	41812/008	14-15		39
41056/004	53	41580/003	101		16		41
41056/051	53	41580/040	97-99		17		20
41056/052	53	41580/041	99		18		21
41056/053	53	41580/045	97-99		19		22
41056/054	51	41580/046	97-99		20		23
41056/055	51	41580/047	101		21		24
41056/056	51-121	41580/050	97-99		22		25
41060/001	49-51	41580/051	101		23		27
41060/050	49	41580/052	97-99-101		24	41929/003	14-15
41060/051	49	41580/053.3	97-99		25		37
41060/052	49	41580/053.4	97-99		27		41
41060/053	49	41580/053.5	99		37		43
41060/054	49	41580/053.6	101		39		45
41060/055	49	41580/053.8	101		41		47
41060/056	49	41580/054	99		47		49
41080/001	120	41580/055	97-99-101		49		51
41080/002	120	41580/056.3	97-99		51		63
41080/003	120	41580/056.4	97-99		53		65
41080/004	120	41580/056.5	99		45		67
41080/005	120	41580/056.6	101		43		69
41080/008	120	41580/056.8	101		63		71
41100/050	63-65	41580/057	97-99-101		65		73
41101/001	22-63	41580/058	99		67		85
41101/800	22	41580/059	101		69		87
41101/802	22	41580/060	101		71		89
41102/001	23-65	41580/065	101		73		109
41102/050	63-65	41580/070	97-99		85		110
41102/800	23	41580/071	97-99-101		87		116
41102/802	23	41580/071	101		89	41841/001	75-77-116
41120/021	71	41580/072	99		97	41841/009	73-110-116
41120/023	71	41580/073	101		99	41850/001	85-87-117
41120/050	71	41580/074	101		101	41850/002	75-77-117
41120/051	71	41580/080	101		109	41850/003	75-77-117
41120/052	71	41590/106	97-99-101		110	41850/004	75-77-117
41124/001	75	41600/001	49-106		118	41903/014	112
41125/005	73	41600/013	37-39	41812/050	119	41905/004	14-15
41125/007	73	41600/014	14-15	41812/051	116-119		16
41125/050	73	41605/802	45-47	41812/052	119		17
41126/051	69		51	41812/054	119		18
41127/003	25		53	41817/001	119		19
41127/023	69		110	41820/001	114		20
41127/029	69	41615/008	75	41820/050	114		21
41127/101	69-71	41615/801	69-71	41820/051	114		22
41127/810	25		73	41820/053	114		23
41127/811	25		109	41821/001	115		24
41134/001	77	41623/001	24-67	41821/048	115		25
41134/002	75	41623/800	24	41830/005	115		26
41134/003	77	41623/801	24	41830/006	115		27
41180/053	75	41625/003	87-106	41830/007	14-15		37

DOORS, WINDOWS AND SHUTTERS

CODE INDEX

CODE	P.	CODE	P.	CODE	P.	CODE	P.	CODE	P.
41704/002	141-177	42282/075	177	43300/002	133	43492/003	153	43665/015	141-203
41704/004	141-177	42282/076	177	43302/001	134	43493/050	153	43665/018	205
41704/005	141	42282/077	177	43302/002	134	43493/051	153	43701/050	203
41812/008	141	42282/078	175	43302/003	134	43493/052	153	43701/051	203
41841/009	141	42282/082	177	43302/011	134	43493/053	153	43701/052	205
41903/014	203	42282/092	176-193	43302/802	132	43501/050	155	43701/055	205
41905/001	203	42282/096	193	43302/803	132	43502/001	155	43701/063	205
41905/002	203	42282/097	176	43302/804	132	43502/002	155	43800/001	133
41905/004	203-175	42283/090	176	43310/005	135	43502/003	155	43801/001	134
	141	42283/091	176	43310/006	135	43503/021	155	43801/002	134
41923/007	175	42283/092	176	43310/007	135	43503/022	155	43801/003	134
41923/009	193	42283/094	193	43320/001	137	43503/023	155	43802/002	134
41923/055	203	42283/096	176	43320/002	137	43503/024	155	43802/003	134
41929/001	203	42283/098	176	43320/003	137	43503/025	155	43810/001	135
42000/001	172	42300/002	175	43330/001	137	43503/026	155	43810/002	135
42000/006	172	42300/006	175	43330/002	137	43503/055	155	43810/003	135
42000/010	172	42300/007	183-175	43330/003	137	43503/056	155	43901/001	135
42100/200	171	42605/001	193	43340/001	138	43509/015	151	43901/005	135
42100/250	171	42605/002	193	43345/001	138	43509/050	151	49520/084	186
42100/300	171	42605/003	193	43364/001	141	43509/051	151	49520/085	186
42100/360	171	42605/050	193	43364/002	141	43531/050	159	49520/086	186
42100/400	171	42605/051	193	43364/003	141	43531/051	159	49520/087	186
42100/440	171	42605/056	193	43364/004	141	43531/052	159	49520/088	190
42100/480	171	42605/057	193	43364/050	141	43531/053	159	49520/089	190
42100/540	171	42605/058	193	43380/057	132-137	43531/054	159	49520/090	190
42100/600	171	42605/059	193	43380/058	136	43545/008	157	49520/091	190
42101/200	171	42605/060	193	43380/059	136	43545/009	157	49520/092	190
42101/250	171	42605/061	193	43380/060	136	43545/010	157	49520/093	190
42101/300	171	42705/201.0	171	43380/063	136	43545/050	157	49520/094	190
42101/360	171	42705/201.1	171	43380/064	136	43550/001	163	49520/095	190
42101/400	171	42705/201.2	171	43380/066	139	43550/051	163	49520/096	190
42101/440	171	42705/251.0	171	43380/068	137	43562/002	163	49520/097	190
42101/480	171	42705/251.1	171	43380/070	139	43562/004	163	49520/098	190
42101/540	171	42705/251.2	171	43380/071	139	43562/006	163	49520/099	190
42101/600	171	42705/301.0	171	43380/072	139	43562/008	163	49520/100	190
42102/200	171	42705/301.1	171	43380/073	139	43562/052	163	49520/101	190
42102/250	171	42705/301.2	171	43380/076	139	43562/054	163	49520/102	190
42102/300	171	42705/361.0	171	43380/077	133	43562/055	163	49520/103	190
42102/360	171	42705/361.1	171	43380/078	136	43562/057	163	49520/104	190
42102/400	171	42705/361.2	171	43380/079	136	43562/058	163	49520/105	190
42102/440	171	42705/401.0	171	43380/081	138	43562/059	163	49520/106	190
42102/480	171	42705/401.1	171	43380/082	133	43562/060	163	49520/107	190
42102/540	171	42705/401.2	171	43380/083	132-136	43562/061	163	49520/108	190
42102/600	171	42705/441.0	171	43380/084	136	43562/062	163	49520/109	190
42200/012	185	42705/441.1	171	43380/085	138	43562/063	163	49520/110	190
42200/013	185	42705/441.2	171	43380/086	138	43563/001	163	49520/111	190
42200/014	185	42705/481.0	171	43380/087	133	43563/002	163	49520/112	190
42200/015	185	42705/481.1	171	43380/088	137	43563/003	163	49520/113	190
42200/016	185	42705/481.2	171	43380/089	139	43563/006	163	49520/114	190
42200/050	178	42705/541.0	171	43380/090	139	43563/007	163	49520/115	190
42200/051	185	42705/541.1	171	43380/091	133	43563/008	163	49520/116	190
42200/052	179	42705/541.2	171	43380/092	136	43563/010	163	49520/117	190
42200/053	185	42715/201.0	170	43380/093	139	43563/011	163	49520/118	190
42200/054	185	42715/201.1	170	43380/094	139	43563/012	163	49520/119	190
42201/051	178	42715/201.2	170	43380/095	139	43563/021	163	49520/120	190
42205/001	188	42715/251.0	170	43380/096	139	43563/026	163	49520/121	190
42205/002	188	42715/251.1	170	43380/097	139	43563/030	163	49520/122	190
42205/003	188	42715/251.2	170	43380/098	139	43564/001	163	49520/126	191
42205/004	188	42715/301.0	170	43380/099	138	43564/002	163	49520/127	191
42205/005	188	42715/301.1	170	43380/100	138	43564/003	163	49520/128	191
42205/006	188	42715/301.2	170	43380/101	137	43564/006	163	49520/129	191
42205/007	188	42715/361.0	170	43380/104	137	43564/007	163	49520/130	191
42205/008	188	42715/361.1	170	43380/105	137	43564/008	163	49520/131	191
42205/009	189	42715/361.2	170	43380/106	139	43564/010	163	49520/132	191
42205/010	189	42715/401.0	170	43380/107	136	43564/011	163	49520/133	191
42205/011	189	42715/401.1	170	43380/108	136	43564/012	163	49520/134	191
42205/012	189	42715/401.2	170	43380/109	137	43564/021	163	49520/135	191
42205/015	189	42715/441.0	170	43380/110	137	43564/026	163	49520/136	191
42205/016	189	42715/441.1	170	43380/111	137	43564/030	163	49520/137	191
42205/017	189	42715/441.2	170	43380/112	139	43571/001	159	49520/138	191
42205/019	189	42715/481.0	170	43380/113	139	43571/002	159	49520/139	191
42205/061	189	42715/481.1	170	43380/114	139	43572/001	159	49520/140	191
42280/061	178	42715/481.2	170	43380/115	133	43572/002	159		
42280/067	178	42715/541.0	170	43380/116	136	43572/003	159		
42280/068	172	42715/541.1	170	43380/118	138	43573/001	159		
42280/070	183	42715/541.2	170	43380/119	137	43573/002	159		
42280/071	179	42715/601.0	170	43380/124	136	43573/003	159		
42280/075	183	42715/601.1	170	43380/125	138	43574/050	159		
42280/076	183	42715/601.2	170	43380/131	138	43574/051	159		
42280/077	179	42900/002	172	43380/156	132-136	43574/052	159		
42280/079	179	42902/003	172	43380/161	136	43580/064	159		
42280/081	183	42902/051	172	43400/052	145	43580/065	159		
42280/084	177	42902/052	174	43400/053	145	43580/067	159		
42280/085	177	42902/053	172	43400/054	145	43580/068	159		
42280/088	183	42902/054	172	43400/055	145	43645/004	203		
42281/060	185	42902/055	172	43400/056	145	43645/005	205		
42281/061	179	42902/056	172	43400/057	145	43660/002	205		
42281/062	179	42910/003	178	43400/059	145	43660/006	205		
42281/063	179	42910/006	172	43400/801	145	43660/007	205		
42281/064	179	42910/008	178	43400/802	145	43660/008	205		
42282/070	175	42910/010	178	43492/001	153	43660/101	205		
42282/073	175	43300/001	133	43492/002	153	43665/004	203		

Aprimatic. Certified Quality.

Aprimatic is Urmet S.p.A.'s company access automation systems. Aprimatic products are designed, developed and manufactured in compliance with **UNI EN ISO 9001** standards. This internationally acknowledged certification attests Urmet S.p.A.'s status as a leader in the Communication, Security and Building Automation industry and to the all-round quality of its products and services.

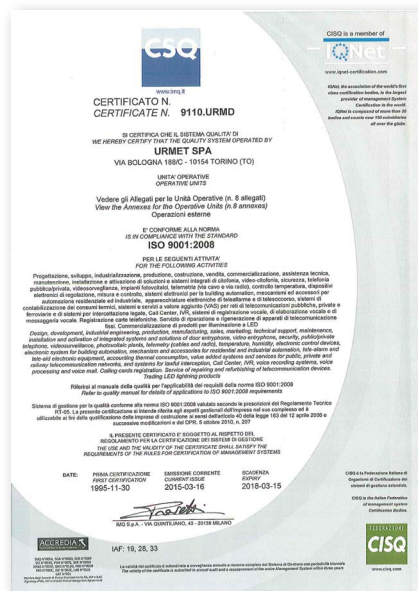

All Aprimatic products bear the mark 

Aprimatic is a registered trademark belonging to Aprimatic S.r.l.

THE URMET GROUP

Urmet Group.
Communication, security and energy.
All over the world, in every project.

Urmet Group means integration of expertise and international dimensions, to offer global solutions to its partners. Born in Italy, it was able to develop internationally and now it has a significant presence on the world market. Our Group designs, develops and markets

products and systems in the communication and security sectors, as well as in energy management and saving and telecommunications. In Italy it is a leading manufacturer of video door phone and telephone systems, access automation systems and control, professional intrusion

alarm systems, fire alarm and video surveillance systems, from private homes to town redevelopment planning, up to large public infrastructures. It is as a global partner for product quality and service efficiency.



SYSTEMS FOR INTEGRATED COMMUNICATION AND SECURITY

Systems and Products for Video Door Phone, Intrusion Alarm, Access Control, Fire Alarm, Video Surveillance, Residential Applications.



SYSTEMS FOR ENERGY MANAGEMENT AND SAVING

Photovoltaic, Wind Power, Hydroelectric Power, Geothermal Energy, Biomass. Heat Metering and Management Systems.



TELECOMMUNICATION SYSTEMS AND SOLUTIONS

Terminals, Telemetry Systems, Road Lighting, Public Telephone Network Systems, Heat Exchangers, Transport, Remote Management Systems.

APRIMATIC

The champion of automation.

Aprimatic is the leader in Italy and in Europe for access automation systems. Thanks to the experience gained in two decades of presence in the market and the very high know-how of

designers, engineers, testers and consultants, Aprimatic offers its customers high performance, product reliability and value retention in time. Today, Aprimatic is the only company offering

all kinds of automation systems, with a complete range of products suitable for residential, commercial and industrial application as well as for public areas.



EXTERNAL CLOSING SYSTEMS

Technological solutions for swing and sliding gates, up-and-over doors and traffic barriers.



DOORS, WINDOWS AND SHUTTERS

Systems for rolling shutters, shutters, windows and domes, sliding doors and home automation.



KIT

Ready-made solutions to meet the most common residential automation requirements.

Catalogue guide

EXTERNAL CLOSING SYSTEMS

The RED section of the catalogue features automation systems for gates, up-and-over doors and for entrances installed in public areas, as well as all-in-one kits for a wide range of automation needs in residential and industrial applications

DOORS, WINDOWS AND SHUTTERS

The WHITE section of the catalogue presents automation devices for doors, windows and rolling shutters. A specific chapter of this section is devoted to home automation solutions

technical info

The GREY appendix contains the technical data sheets with product dimensions



AT THE SERVICE OF PROFESSIONALS

A COMPLETE RANGE

Aprimatic offers a complete range for every type of product, satisfying the needs of all end users and ensuring their complete satisfaction.

COMMERCIAL ORGANISATION

Aprimatic supports its customers during the entire process, helping them choose the best solution, providing assistance and guaranteeing a complete and accurate service. The sales network covers the entire Italian territory and responds in real time to doubts or installation needs, providing specialised, competent and timely support.

CUSTOMER SERVICE

Aprimatic Customer Service is available to companies and installers to provide all the necessary support during installation and operation of the equipment.



SERVICE NETWORK

Over forty authorised service centres throughout Italy constitute an extensive, homogeneous and always up-to-date network.

WEB

Click on www.aprimatic.com to enter a world of information and services designed for end customers and installers, including special on-line services such as consultation of detailed exploded views.

TRAINING

Meetings for the presentation of news, courses on new products and systems, update seminars on professional and regulatory issues improve the quality of everyone's work and represent a benefit for end customers.



SHOWCASE

Traffic barriers

24V barriers used for the management of continuous use car parks in large apartment buildings, companies, or even private car parks with frequent passage of vehicles during the day.

Hydraulic operators

Hydraulic operators for swing gates with hydraulic brake during opening and closing.

Operator for up-and-over doors

Brand new low-voltage electromechanical operator for sectional and counterweight-balanced up-and-over doors.

12V Photocells

The wall-mounted photocells with a 20-metre range can also be welded onto a post. They are self-aligning and with IP45 protection degree. They operate with 12V and 24V power supply.

NEW
AT APRIMATIC:
**ARMS, OPERATORS
AND PHOTOCELLS**



SERIE HARRIER
P. 94



FORTY TWENTY 270
P. 44-46



MATIC-BOX 800/1200
P. 88



ER12-24V
P. 118



Radar

New microwave + IR mixed technology radar for automatic door control.

Wireless tubular motors

The entire range of Aprimatic Revolux, known for its performance and reliability, is now available version with control multiposition for the management of the movement of adjustable shutters, with integrated receiver.

Remote controls for tubular motors

The new Revolux wireless remote controls for tubular motors are available with one or five programmable channels.

Gate remote control

New remote control for gates and up-and-over doors supporting up to 4 radio channels for the transmission of pulses.

THE NEWS:
**RADAR, WIRELESS
 TUBULAR MOTORS
 AND REMOTE
 CONTROLS**



DT90C
P.176



SERIE REVOLUX MP
P. 126



1 / 5 CANALI
P. 135



TM4
P. 112



01. AUTOMATION KITS

KIT RAIDER 2500
KIT AP424
KIT AP423
KIT G-MATIC AP350
KIT FLEXI
KIT TWENTY 270
KIT MONZA ONDA 424
KIT HOCKENHEIM ONDA 624
KIT ONDA 623
KIT INDIANAPOLIS ONDA 801
KIT ESTORIL ALZO
KIT MATIC-BOX 800
KIT MATIC-BOX 1200





EUROPEAN STANDARDS

Standards **EN 12453** and **EN 12445** set out the minimum safety parameters. For automatic closing systems whose operation involves persons. These standards allow the identification of the necessary technical measures aimed at ensuring the safety of users and facilities.

Classification criteria include the position of the system, the type of user and the control mode.



THE SYSTEM can be:

a system can be found in a delimited **private area**, in a **private area which adjoins a public area** or in a completely **public area**.



THE USER can be:

a user is **not instructed** when he/she has not received the necessary information to operate the automation system; this generally happens for automation systems found in public areas. For automation systems in private areas, instead, the user is usually **instructed**.



THE CONTROL can be:

the system can be controlled in a number of ways: **automatic** when the pulse activates a series of operations and not a single action; **radio-controlled** if a pulse corresponds to a single operation (e.g.: opening or closing); operated by **pulses from a fixed position** if the activation of the system is possible from a single location even without automatic control reset; finally, it may lack the **self-holding** function, if the desired action lasts as long as the command activation.



MANDATORY SAFETY DEVICES

- A – Operator present and control with automatic reset
- B – Operator present and control with manual reset
- C – Mechanical or electronic devices (you need to check the conformity of the impact forces tolerated compared to reference standards)
- D – Infrared photocells to detect obstacles in the operation area

THE SCENARIO – REGULATORY REQUIREMENTS

	Control device			
	without self-holding	with pulse from a fixed position	radio control	automatic
private user	A	C	C	C + D
private area not instructed user	C	C	C + D	C + D
public area instructed user	B	C	C + D	C + D
public area not instructed user	~	C + D	C + D	C + D

EXAMPLE OF A TYPICAL SYSTEM COMPLIANT WITH EN 12453 - EN 12445 STANDARDS

System **ON A PUBLIC AREA**

The system marks the boundary between a private and a public area (e.g., the driveway gate with a ramp for a condominium garage).

User **INSTRUCTED**

The system is activated by people having received a proper training on the automation system operation.

Control **RADIO**

To send pulses even from a fixed position (e.g. from a desktop) or from a mobile station.

Safety is guaranteed by **INFRARED BEAM PHOTOCELLS**

Automatic automation systems are designed for connection of all types of infrared beam photocells, ensuring greater safety for the user.

SAFETY EDGES

Sensitive edge used to prevent the risk of crushing due to electric gates movement. In case of contact, the automation system inverts motion and prevents damage to people and property.



CHOOSING THE RIGHT PRODUCT

Easy to purchase, fast to install

Aprimatic optimises your stock with only a few references. Packaging is designed to ensure exceptionally clear and readable information, making it easier to find the right product. Aprimatic has already identified all the difficulties that may be encountered by installers when working with highly

technological solutions and has therefore decided to solve these problems with practical ready-to-use kits. Everything you need is ready for assembly: discover the advantage of these genuine technological gems to make your installations quicker, easier and more durable.

Three-year warranty.
Aprimatic kits are covered by an extended warranty.
For an unbeatable long-lasting safety.



TYPES

SWING GATES

Recommended installation for gates with one or two wings, where the operating space is reduced by the presence of walls and fences. Wings usually open inwards inside the property and require a certain room for movement.



Operators with vertical engine

- KIT G-MATIC AP350



Articulated arm operators

- KIT RAIDER 2500
- KIT AP423
- KIT AP424
- KIT TWENTY 270 B
- KIT TWENTY 270 C
- KIT TWENTY 270 SF

- KIT FLEXI

SLIDING GATES

Easy installation, ideal for moving a single wing, equipped with rack, running on a ground rail. This type of system is used in long and narrow spaces where the gate slides during opening and closing.



- KIT MONZA ONDA 424
- KIT HOCKENHEIM ONDA 624
- KIT ONDA 623
- KIT INDIANAPOLIS ONDA 801

UP-AND-OVER DOORS

Ideal installation for spring-loaded or counterweight-balanced up-and-over doors and sectional doors, for residential use.

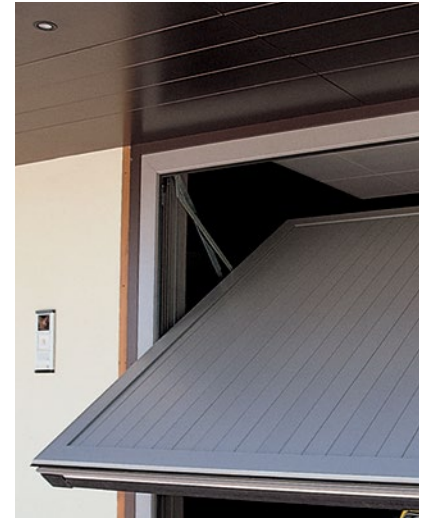

- KIT ESTORIL ALZO
- KIT GA-MATIC CF 800
- KIT GA-MATIC CF 1000

**Electromechanical wing operator KITS**

KIT NAME	WING WIDTH (m)			WING WEIGHT (kg)	USE
	1,8	3,0	4,0		
RAIDER 2500				500 300	
AP423/AP424				300 200	
AP 350				350	

(*) For gates with wings longer than 1.8m, it is necessary to use the electric lock.

Hydraulic wing operator KITS

KIT NAME	WING WIDTH (m)			WING WEIGHT (kg)	USE
	1,8	3,0	4,0		
TWENTY 270				~ ~	

(*) For gates with wings longer than 1.8m, it is necessary to use the electric lock.

Articulated arm operator KITS

KIT NAME	WING WIDTH (m)			WING WEIGHT (kg)	USE
	1,8	3,0	4,0		
FLEXI				300	

Sliding gate KITS

KIT NAME	WING WEIGHT (kg)	USE
MONZA ONDA 424 (24V)	400	
HOCKENHEIM ONDA 624 (24V)	400 600	
ONDA 623 (230V)	400 600	
INDIANAPOLIS ONDA 801 (230V)	500 800	

Up-and-over door operator KITS

KIT NAME	MAX. DOOR DIMENSION	USE
ESTORIL ALZO	3,5 x 3,0 m	
MATIC-BOX 800	10-12 m ²	
MATIC-BOX 1200	14-18 m ²	

KEY

RESIDENTIAL

CONDOMINIUM

INDUSTRIAL



KIT RACING RAIDER 2500

41026/800-801



Self-learning configuration and possibility of adjusting the parameters through a simple and intuitive menu.

Pre-drilled adjustable rear bracket. The arms are equipped with mechanical limit stops to allow stroke adjustment.

Continuous operation guaranteed, in case of power supply failure, by two optional emergency batteries.

The use of an electric lock is recommended **for gate wings longer than 1.8 metres.**



TECHNICAL DATA

MAIN POWER SUPPLY	230 Vca - 50 Hz
MOTOR POWER SUPPLY	24 Vdc
MAX. THRUST FORCE	2500 N
MAX. WING WIDTH WITHOUT ELECTRIC LOCK	1,8 m
MAX. WING WIDTH WITH ELECTRIC LOCK	3 m
MAX. WING WEIGHT	300 kg (for 3 m wing) 500 kg (for 1.8 m wing)
WEIGHT KIT	10 kg

Kit for swing gates, for residential use, with electromechanical arm operator.

OPERATOR DIMENSIONS

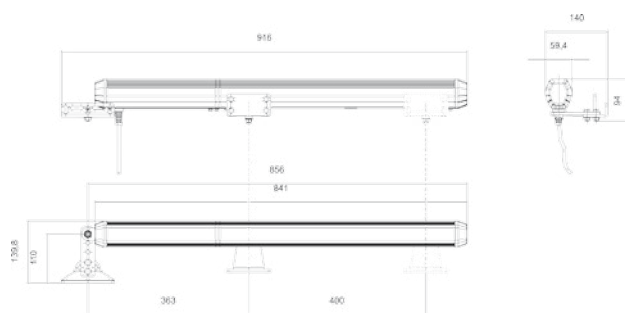

KIT 41026/801: **733,47** euro. The kit includes:

ITEM NUMBER	DESCRIPTION	Pcs.
41026/001	RAIDER 2500 Operator	2
41600/014	RSK-24-2500 control unit (with receiver 433.92MHz PL-ECO)	1
41905/004	TM4 - 433.92 MHz four-channel transmitter	1
41929/003	KIT antenna 433.92 MHz for ET2N-ET20N	1

ITEM NUMBER	DESCRIPTION	Pcs.
41812/008	ER 12-24V Pair of photocells	1
	Aprimatic signal panel	

41026/800: **792,67** euro. The kit includes (in addition to 41026/801):

41840/006	ET2N flashing light	1
41830/007	PC12E Wall-mounted key-operated switch	1

[*] For gates with wings longer than 1.8 m, it is necessary to use the electric lock.

NOTE: Not compatible with previous Raider model

NOTE: For the available safety and signalling devices and for installation accessories, see section "Control units and indicators" in this catalogue (refer to the initial index).

NOTE: All prices are subject to variation.

KIT AP424

41033/800-801

Elegant design suggests classic hydraulic models.

Irreversible motor for a maximum power during the closing.

Multiposition brackets for easy and fast assembly.

Stainless steel screw for maximum strengness and long life.



Kit for swing gates, for residential, with electromechanical arm operator.

TECHNICAL DATA

MAIN POWER SUPPLY	230 Vac - 50 Hz
MOTOR POWER SUPPLY	24 Vdc
MAX. THRUST FORCE	1500N
MAX. WING WIDTH WITHOUT ELECTRIC LOCK	1,8 m
MAX. WING WIDTH WITH ELECTRIC LOCK	3 m
MAX. WING WEIGHT	300 kg (for 2 m wing) 200 kg (for 3 m wing)
WEIGHT KIT	15 kg

(*) For gates with wings longer than 1.8 m, it is necessary to use the electric lock.

OPERATOR DIMENSIONS

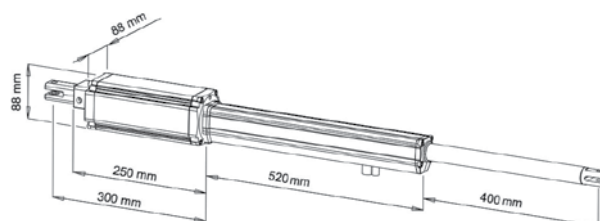

41033/801: **649,00** euro. The kit includes:

ITEM NUMBER	DESCRIPTION	Pcs.
41033/001	AP424 Operator	2
41600/014	RSK-24-2500 control unit (with receiver 433.92MHz PL-ECO)	1
41905/004	TM4 - 433.92 MHz four-channel transmitter	2
	Aprimatic signal panel	1

41033/800: **899,00** euro. The kit includes: (in addition to 41033/801)

ITEM NUMBER	DESCRIPTION	Pcs.
41840/006	ET2N flashing light	1
41812/008	ER 12-24V Pair of photocells	1
41830/007	PC12E Wall-mounted key-operated switch	1
41929/003	KIT antenna 433.92 MHz for ET2N-ET20N	1

NOTE: For the available safety and signalling devices and for installation accessories, see section "Control units and indicators" in this catalogue (refer to the initial index).

NOTE: All prices are subject to variation.



KIT AP 423

41032/800-801



Elegant design suggests classic hydraulic models.

Irreversible motor for a maximum power during the closing.

Multiposition brackets for easy and fast assembly.

Stainless steel screw for maximum strengness and long life.



Kit for swing gates, for residential, with electromechanical arm operator.

TECHNICAL DATA

MAIN POWER SUPPLY	230 Vac - 50 Hz
MAX. THRUST FORCE	1500N
MAX. WING WIDTH WITHOUT ELECTRIC LOCK	1,8 m
MAX. WING WIDTH WITH ELECTRIC LOCK	3 m
MAX. WING WEIGHT	300 kg (for 2 m wing) 200 kg (for 3 m wing)
WEIGHT KIT	15 kg

(*) For gates with wings longer than 1.8 m, it is necessary to use the electric lock.

OPERATOR DIMENSIONS

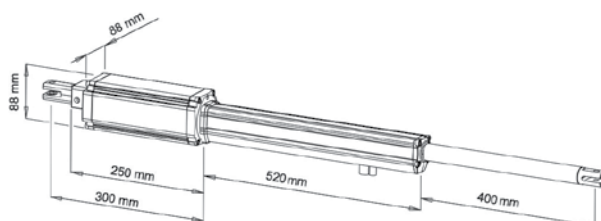

41032/801: **649,00** euro. The kit includes:

ITEM NUMBER	DESCRIPTION	Pcs.	
41032/001	AP423 Operator	2	
41628/001	BA230 control unit (with receiver 433.92Mhz)	1	
41905/004	TM4 - 433.92 MHz four-channel transmitter	2	
	Aprimatic signal panel		

KIT 41032/800: **899,00** euro. The kit includes: (in addition to 41032/801)

ITEM NUMBER	DESCRIPTION	Pcs.	
41840/006	ET2N flashing light	1	
41812/008	ER 12-24V Pair of photocells	1	
41830/007	PC12E Wall-mounted key-operated switch	1	
41929/003	KIT antenna 433.92 MHz for ET2N-ET20N	1	

NOTE: For the available safety and signalling devices and for installation accessories, see section "Control units and indicators" in this catalogue (refer to the initial index).

NOTE: All prices are subject to variation.



KIT G-MATIC AP 350

41035/800-801

NEW**230V****350K****3**
warranty**i209**

Made in Italy.

Resistant to high and low temperature.
Simple installation with brackets secured to the gate. The most widespread among swing gate automation systems. Possibility to create single or double wing systems. Unit control with microprocessor and 433Mhz receiver, easy setting; Irreversible operator with key to lock and unlock.

Complies with the current safety standards as regards to obstacle detection and inversion of movement in accordance with **EN12453** and **EN12445** (product certified under ideal installation conditions).

TECHNICAL DATA

MAIN POWER SUPPLY	230 V - 50 Hz
MAX. WING WIDTH WITHOUT ELECTRIC LOCK	1,8 m
MAX. WING WIDTH WITH ELECTRIC LOCK	3 m
MAX. WING WEIGHT	350 kg
WEIGHT KIT	17 kg



Kit for swing gates up to 350Kg per leaf. Residential use, with electromechanical arm operator.

OPERATOR DIMENSIONS

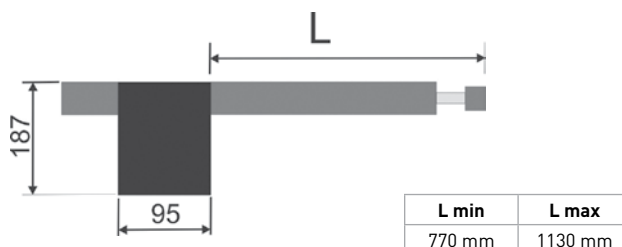

41035/801: **603,87** euro. The kit includes:

ITEM NUMBER	DESCRIPTION	Pcs.
41035/001	Left swing gate operator	1
41035/002	Right swing gate operator	1
41628/001	BA230 control unit (with receiver 433.92MH)	1
41905/004	TM4 433,92 Mhz four channel transmitter	2
	Aprimatic signal panel	

41035/800: **703,13** euro. The kit includes: (in addition to 41035/801):

ITEM NUMBER	DESCRIPTION	Pcs.
41840/006	ET2N - 24 V LED flashing light	1
41812/008	ER 12-24V Pair of photocells	1
41929/003	Antenna Kit	1

NOTE: For the available safety and signalling devices and for installation accessories, see section "Control units and indicators" in this catalogue (refer to the initial index).

NOTE: All prices are subject to variation.



KIT FLEXI

41029/800



Articulated arm fitted with mechanical limit stop, to adjust the stroke and prevent the positioning in negative angle.

Control unit on board of the operator, with full self-learning configuration. It can move wings having a maximum length of 3 m (without electric lock).

Ideal for gates with large pillars.



Articulated electromechanical arm for swing gates for residential use.

TECHNICAL DATA

MAIN POWER SUPPLY	230 Vca - 50 Hz
MOTOR POWER SUPPLY	24 Vdc
MAX. WING WIDTH	3 m
WITHOUT ELECTRIC LOCK	
MAX. WING WEIGHT	300 kg
PROTECTION DEGREE	IP44
WEIGHT KIT	30 kg

OPERATOR DIMENSIONS

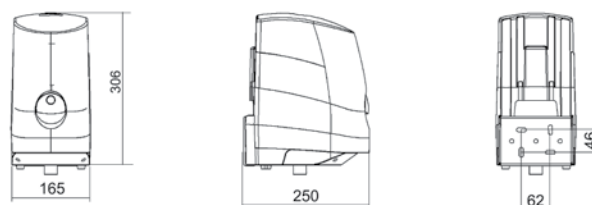

KIT 41029/800: **1389,40** euro. The kit includes:

ITEM NUMBER	DESCRIPTION	Pcs.	
41029/001	FLEXI 300 OPERATOR 1 operator Master with dedicated on-board electronic unit and 433.92MHz built-in radio receiver 1 operator Slave	2	
41029/054	Articulated arm for FLEXI operator	2	
41905/004	TM4 - 433.92 MHz four-channel transmitter	1	
41812/008	ER12-24V - Pair of photocells	1	

ITEM NUMBER	DESCRIPTION	Pcs.	
41929/003	KIT antenna 433.92 MHz for ET2N-ET20N	1	
41840/006	ET2N - 24 V LED flashing light	1	
41830/007	PC12E - Wall-mounted key-operated switch	1	
	Aprimatic signal panel		

NOTE: For the available safety and signalling devices and for installation accessories, see section "Control units and indicators" in this catalogue (refer to the initial index).

NOTE: All prices are subject to variation.

KIT TWENTY 270 B

41012/800



Simple and linear design with a compatible aesthetics for all types of gates.

The slowing down system in the closing (adjustable by control unit) allows a soft approach of the wings, silently and without mechanical stress to the structure;

Emergency release system under the top cover.

It equipped with front hitch ball joint uniball threaded 20mm, like the previous range ZT44, which allows to retrieve any tolerances during the fixing.

Extremely sturdy and flexible pillar mounting thanks to the rear flange with articulated aluminium fork.



Kit for swing gates, with hydraulic operator with lock on openings and closing. Condominium use.

TECHNICAL DATA

MAIN POWER SUPPLY	230 V - 50 Hz
MAX. WING WIDTH WITH ELECTRIC LOCK	4 m
MAX. CYCLE NUMBER	800 cycles/day
WEIGHT KIT	23 kg

OPERATOR DIMENSIONS

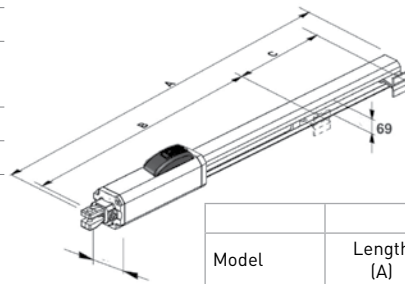

Model	DIMENSIONS (mm)		
	Length (A)	Distance attacks (B)	Rod stroke (C)
TWENTY 270	990	723	270

KIT 41012/800: **1249,00** euro. The kit includes:

ITEM NUMBER	DESCRIPTION	Pcs.
41012/001	Operator TWENTY 270 B	2
41628/001	BA230 control unit (with receiver 433.92Mhz)	1
41905/004	TM4 - 433.92 MHz four-channel transmitter	2
41929/003	KIT antenna 433.92 MHz for ET2N-ET20N	1

ITEM NUMBER	DESCRIPTION	Pcs.
41840/006	ET2N - 24 V LED flashing light	1
41812/008	ER12-24V - Pair of photocells	1
41830/007	PC12E - Wall-mounted key-operated switch	1
	Aprimatic signal panel	

NOTE: For the available safety and signalling devices and for installation accessories, see section "Control units and indicators" in this catalogue (refer to the initial index).

NOTE: All prices are subject to variation.



KIT TWENTY 270 C

41012/802



Simple and linear design with a compatible aesthetics for all types of gates.

The slowing down system in the closing (adjustable by control unit) allows a soft approach of the wings, silently and without mechanical stress to the structure;

Emergency release system under the top cover.

It equipped with front hitch ball joint uniball threaded 20mm, like the previous range ZT44, which allows to retrieve any tolerances during the fixing.

Extremely sturdy and flexible pillar mounting thanks to the rear flange with articulated aluminium fork.



Kit for swing gates, with hydraulic operator with lock on closing. Condominium use.

TECHNICAL DATA

MAIN POWER SUPPLY	230 V - 50 Hz
MAX. THRUST FORCE	5500N
MAX. WING WIDTH WITHOUT ELECTRIC LOCK	1,8 m
MAX. WING WIDTH WITH ELECTRIC LOCK	3 m
MAX. CYCLE NUMBER	800 cycles/day
WEIGHT KIT	23 kg

OPERATOR DIMENSIONS

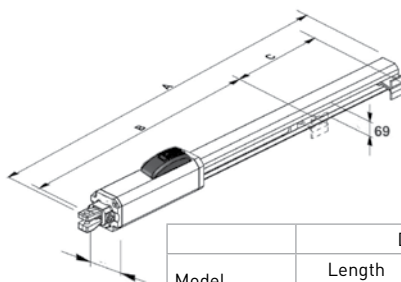

Model	DIMENSIONS (mm)		
	Length (A)	Distance attacks (B)	Rod stroke (C)
TWENTY 270	990	723	270

KIT 41012/802: **1349,00** euro. The kit includes:

ITEM NUMBER	DESCRIPTION	Pcs.	
41012/002	Operator TWENTY 270 C	2	
41628/001	BA230 control unit (with receiver 433.92Mhz)	1	
41905/004	TM4 - 433.92 MHz four-channel transmitter	2	
41929/003	KIT antenna 433.92 MHz for ET2N-ET20N	1	

ITEM NUMBER	DESCRIPTION	Pcs.	
41840/006	ET2N - 24 V LED flashing light	1	
41812/008	ER12-24V - Pair of photocells	1	
41830/007	PC12E - Wall-mounted key-operated switch	1	
	Aprimatic signal panel		

(*) For gates with wings longer than 1.8 m, it is necessary to use the electric lock.

NOTE: For the available safety and signalling devices and for installation accessories, see section "Control units and indicators" in this catalogue (refer to the initial index).

NOTE: All prices are subject to variation.



KIT TWENTY 270 SF

41012/804



Simple and linear design with a compatible aesthetics for all types of gates.

The slowing down system in the closing (adjustable by control unit) allows a soft approach of the wings, silently and without mechanical stress to the structure;

Emergency release system under the top cover.

It is equipped with front hitch ball joint uniball threaded 20mm, like the previous range ZT44, which allows to retrieve any tolerances during the fixing.

Extremely sturdy and flexible pillar mounting thanks to the rear flange with articulated aluminium fork.



Kit for swing gates, with hydraulic operator without lock on openings and closing. Condominium use.

TECHNICAL DATA

MAIN POWER SUPPLY	230 V - 50 Hz
MAX. THRUST FORCE	5500N
MAX. WING WIDTH WITH ELECTRIC LOCK	3 m
MAX. CYCLE NUMBER	800 cycles/day
WEIGHT KIT	23 kg

OPERATOR DIMENSIONS

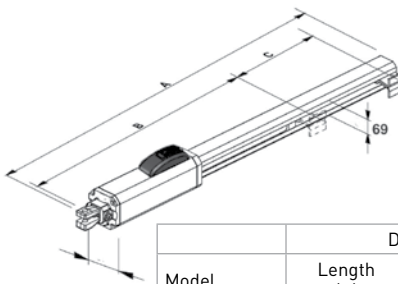

Model	DIMENSIONS (mm)		
	Length (A)	Distance attacks (B)	Rod stroke (C)
TWENTY 270	990	723	270

KIT 40012/804: **1399,00** euro. The kit includes:

ITEM NUMBER	DESCRIPTION	Pcs.
41012/003	Operator TWENTY 270 C	2
41628/001	BA230 control unit (with receiver 433.92Mhz)	1
41905/004	TM4 - 433.92 MHz four-channel transmitter	2
41929/003	KIT antenna 433.92 MHz for ET2N-ET20N	1

ITEM NUMBER	DESCRIPTION	Pcs.
41840/006	ET2N - 24 V LED flashing light	1
41812/008	ER12-24V - Pair of photocells	1
41830/007	PC12E - Wall-mounted key-operated switch	1
	Aprimatic signal panel	

[*] For gates with wings longer than 1.8 m, it is necessary to use the electric lock.

NOTE: For the available safety and signalling devices and for installation accessories, see section "Control units and indicators" in this catalogue (refer to the initial index).

NOTE: All prices are subject to variation.



KIT MONZA ONDA 424

41101/800-802



Complies with the current safety standards as regards to obstacle detection and inversion of movement in accordance with **EN12453** and **EN12445** (product certified under ideal installation conditions).
The electronic torque adjustment combined with encoder technology guarantees a gradual approach during opening and closing movements.

Continuity of operation guaranteed, in the event of a power supply failure, by a set of optional batteries which may be fitted in the operator casing.

Sturdy and reliable thanks to the die-cast aluminium casing.

Worm screw gear motor with aluminium body and on-board electronic control unit. Equipped with adjustable-height foundation plate.

Emergency release lever with customised key, for use during power supply failures.



Kit for sliding gates with wings up to 400 kg.
Residential use.

TECHNICAL DATA

MAIN POWER SUPPLY	230 Vac - 50 Hz
MOTOR POWER SUPPLY	24 Vdc with encoder
MAX. THRUST FORCE	450 N
MAX. GATE WEIGHT	400 kg
HEIGHT OF PINION FROM GROUND	55 mm
MAX. CYCLE NUMBER	100 cycles/day
WEIGHT KIT	10 kg

OPERATOR DIMENSIONS

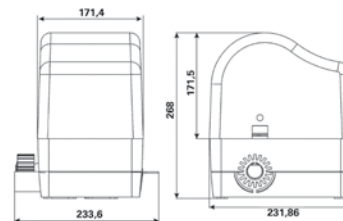

KIT 41101/802: **572,71** euro. The kit includes:

ITEM NUMBER	DESCRIPTION	Pcs.	
41101/001	ONDA 424 gear motor with dedicated on-board electronic control unit, 433.92 MHz built-in superheterodyne radio receiver, release key and foundation kit	1	
41905/004	TM4 - 433.92 MHz four-channel transmitter	1	
41929/003	KIT antenna 433.92 MHz for ET2N-ET20N	1	
41812/008	ER 12-24V Pair of photocells	1	
	Aprimatic signal panel		

KIT 41101/800: **613,08** euro. The kit includes:
(in addition to 41101/802):

ITEM NUMBER	DESCRIPTION	Pcs.	
41840/006	ET2N 24V Led flashing light	1	
41830/007	PC12E Wall-mounted key-operated switch	1	

ITEM NUMBER	ACCESSORIES COMPLETING THE KIT	€
41180/064	CP - Aprimatic 10m plastic rack with steel core and mounts (module 4)	156,09

NOTE: For the available safety and signalling devices and for installation accessories, see section "Control units and indicators" in this catalogue (refer to the initial index).

NOTE: All prices are subject to variation.



KIT HOCKENHEIM ONDA 624

41102/800-802



Complies with the current safety standards as regards to obstacle detection and inversion of movement in accordance with **EN12453** and **EN12445** (product certified under ideal installation conditions). The electronic torque adjustment combined with encoder technology guarantees a gradual approach during opening and closing movements.

Continuity of operation guaranteed, in the event of a power supply failure, by a set of optional batteries which may be fitted in the operator casing.

Sturdy and reliable thanks to the die-cast aluminium casing.

Worm screw gear motor with aluminium body and on-board electronic control unit. Equipped with adjustable-height foundation plate.

Emergency release lever with customised key, for use during power supply failures.



Sliding gate kit. Residential use for wings up to 600 kg.
Condominium use for wings up to 400 kg.

TECHNICAL DATA

MAIN POWER SUPPLY	230 Vac - 50 Hz
MOTOR POWER SUPPLY	24 Vdc with encoder
ABSORBED POWER	80 W
ABSORBED CURRENT	4,2 A
MAX. THRUST FORCE	650 N
MAX. LINEAR SPEED	10 m/min
OPERATING TEMPERATURE	-20° +55° C
MAX. GATE WEIGHT	600 kg
HEIGHT OF PINION FROM GROUND	55 mm
MAX. CYCLE NUMBER	100 cycles/day
WEIGHT KIT	10 kg

OPERATOR DIMENSIONS

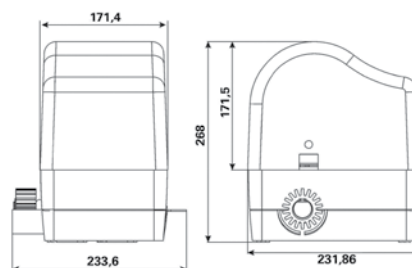

KIT 41102/802: **601,55** euro. The kit includes:

ITEM NUMBER	DESCRIPTION	Pcs.	
41102/001	ONDA 624 gear motor with dedicated on-board electronic control unit, 433.92 MHz built-in superheterodyne radio receiver, release key and foundation kit	1	
41905/004	TM4 - 433.92 MHz four-channel transmitter	1	
41929/003	KIT antenna 433.92 MHz for ET2N-ET20N	1	
41812/008	ER 12-24V Pair of photocells	1	
	Aprimatic signal panel		

KIT 41102/800: **700,17** euro. The kit includes:
(in addition to 41102/802):

ITEM NUMBER	DESCRIPTION	Pcs.	
41840/006	ET2N 24V Led flashing light	1	
41830/007	PC12E Wall-mounted key-operated switch	1	
ITEM NUMBER	ACCESSORIES COMPLETING THE KIT	€	
41180/063	CZ - Aprimatic 4m galvanised steel rack with mounts (module 4)	75,93	

NOTE: For the available safety and signalling devices and for installation accessories, see section "Control units and indicators" in this catalogue (refer to the initial index).

NOTE: All prices are subject to variation.



KIT ONDA 623

41623/800



Complies with the current safety standards as regards to obstacle detection and inversion of movement in accordance with **EN12453** and **EN12445** (product certified under ideal installation conditions). The electronic torque adjustment combined with encoder technology guarantees a gradual approach during opening and closing movements.

Continuity of operation guaranteed, in the event of a power supply failure, by a set of optional batteries which may be fitted in the operator casing.

Sturdy and reliable thanks to the die-cast aluminium casing.

Worm screw gear motor with aluminium body and on-board electronic control unit. Equipped with adjustable-height foundation plate.

Emergency release lever with customised key, for use during power supply failures.



Sliding gate kit. Residential use for wings up to 600kg. Condominium use for wings up to 400Kg.

TECHNICAL DATA

MAIN POWER SUPPLY	230 Vac - 50 Hz
ABSORBED POWER	250 W
ABSORBED CURRENT	1,3 A
MAX. THRUST FORCE	650 N
MAX. LINEAR SPEED	10 m/min
OPERATING TEMPERATURE	-20° +55° C
MAX. GATE WEIGHT	600 kg
HEIGHT OF PINION FROM GROUND	55 mm
MAX. CYCLE NUMBER	100 cycles/day
WEIGHT KIT	10 kg

OPERATOR DIMENSIONS

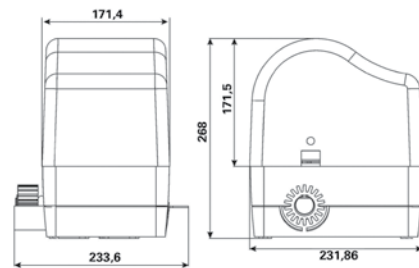

KIT 41623/801: **739,00** euro. The kit includes:

ITEM NUMBER	DESCRIPTION	Pcs.	
41623/001	ONDA 623 gear motor with control unit SC230 on-board. 433.92 Mhz built-in radio receiver, release key and foundation plate kit.	1	
41905/004	TM4 - 433.92 MHz four-channel transmitter	2	
	Aprimatic signal panel		

KIT 41623/800: **779,00** euro. The kit includes: (in additional to 41623/801)

ITEM NUMBER	DESCRIPTION	Pcs.	
41840/006	ET2N 24V Led flashing light	1	
41830/007	PC12E Wall-mounted key-operated switch	1	
41929/003	KIT antenna 433.92 MHz for ET2N-ET20N	1	
41812/008	ER 12-24V Pair of photocells	1	

ITEM NUMBER	ACCESSORIES COMPLETING THE KIT	€
41180/063	CZ - Aprimatic 4m galvanized steel rack with mounts (module 4)	75,93

NOTE: For the available safety and signalling devices and for installation accessories, see section "Control units and indicators" in this catalogue (refer to the initial index).

NOTE: All prices are subject to variation.

KIT INDIANAPOLIS ONDA 801

41127/810-811



Maximum safety thanks to the on-board electronic control unit with electronic torque adjustment.
An additional anti-crushing card can be connected as an optional for gate auto reverse if an obstacle is detected during gate closing.

Steel gears with permanent lubrication.

Because it is self-locking, this gear motor keeps the gate shut. Therefore, it is not necessary to use a lock.

In the event of power supply failure you can proceed with the manual key release via a convenient unlocking device.



Kit for sliding gates. Residential use for wings up to 800 kg.
Condominium use for wings up to 500 kg.

TECHNICAL DATA

MAIN POWER SUPPLY	230 V - 50 Hz
THRUST FORCE	1250 N
MAX. WING WEIGHT	800 kg (residential use) 500 kg (condominium use)
WEIGHT KIT	13 kg

OPERATOR DIMENSIONS

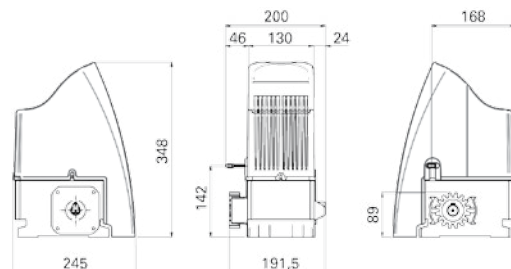

KIT 41127/811: **839,74** euro. The kit includes:

ITEM NUMBER	DESCRIPTION	Pcs.	
41127/023	ONDA 801 gear motor with SC230 on-board electronic control unit, 433.92 MHz built-in superheterodyne radio receiver, release key and foundation kit	1	
41905/004	TM4 - 433.92 MHz four-channel transmitter	1	
41929/003	KIT antenna 433.92 MHz for ET2N-ET20N	1	
41812/008	ER 12-24V Pair of photocells	1	
	Aprimatic signal panel		

41127/810: **947,85** euro. The kit includes:
(in addition to 41127/811)

ITEM NUMBER	DESCRIPTION	Pcs.	
41840/006	ET2N 24V flashing light	1	
41830/007	PC12E Wall-mounted key-operated switch	1	

ITEM NUMBER	ACCESSORIES COMPLETING THE KIT	€
41180/063	CZ - Aprimatic 4m galvanised steel rack with mounts (module 4)	75,93

NOTE: For the available safety and signalling devices and for installation accessories, see section "Control units and indicators" in this catalogue (refer to the initial index).

NOTE: All prices are subject to variation.



KIT ESTORIL ALZO

41210/801



Self-locking gear motor, keeping the up-and-over door closed even in the absence of an electric lock. **External emergency release** (optional) for accessing the garage in case of power supply failure.

Maximum anti-crushing safety for the lower edge of the door, thanks to the on-board electronic control unit equipped with electronic torque adjustment and anti-crushing system (which can be disabled).

Great quality material: steel drive parts, die-cast aluminium gear motor body and ABS protective cover guarantee IP 44 protection degree.

Slowdown system for a soft approach of the door during opening and closing, thus avoiding noise and mechanical stress to the structure.



Kit for counterweight-balanced up-and-over doors with electromechanical operator. Residential use.

TECHNICAL DATA

MAIN POWER SUPPLY	230 V - 50 Hz
MAX. SHEET DIMENSION	3,5 x 3 m (for single motor) 5 x 3 m (for double motor drive)
WEIGHT KIT	10 kg

OPERATOR DIMENSIONS

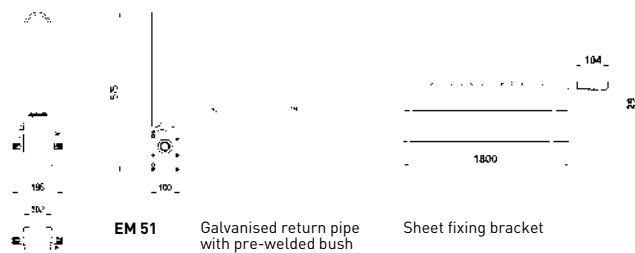

KIT 41210/801: **641,52** euro

ITEM NUMBER	DESCRIPTION	Pcs.
41210/002	ALZO electromechanical operator with T3SC on-board electronic control unit and 433.92 MHz built-in superheterodyne radio receiver	1
41905/004	TM4 - 433.92 MHz four-channel transmitter	1

ITEM NUMBER	DESCRIPTION	Pcs.
41210/058	Pair of plasma-cut, quick-fit curved arms	1
	Aprimatic signal panel	

ITEM NUMBER	ACCESSORIES COMPLETING THE SINGLE MOTOR KIT	€
41210/062	HARDWARE KIT (for single-motor installation) The package includes: Two 1.8 m, Ø 25 mm x 3 galvanised pipes with pre-welded bushes, 180 cm sheet fixing bracket	126,05
For two-motor installations suitable for doors up to 5 x 3 m, add:		
41210/001	EM51 SLAVE OPERATOR Including a pair of 20 cm pipes with splined bush	396,43
41210/061	ST180 - sheet fixing bracket L=180cm	32,45
41210/069	Pair of quick fit straight arms	64,91

NOTE: For the available safety and signalling devices and for installation accessories, see section "Control units and indicators" in this catalogue (refer to the initial index).

NOTE: All prices are subject to variation.

KIT MATIC-BOX 800 / 1200

41243/800 / 41243/810

Maximum anti-crushing safety thanks to the on-board electronic control unit equipped with auto reverse function when an obstacle is detected while closing the gate.

MATIC-BOX operators can be used for sectional doors if installed with the adapter arm accessory, also for counterweight-balanced up-and-over door automation.

Slowdown system for a soft approach of the door during opening and closing, thus avoiding noise and mechanical stress to the structure.

Timed courtesy light built into the operator to light up the garage during opening and closing.

Silent and resistant thanks to the belt drive.

Continuity of operation guaranteed, in the event of a power supply failure, by a set of optional batteries which may be fitted in the operator casing.



Kit with low-voltage electromechanical operator for sectional and counterweight-balanced up-and-over doors. Residential use.

TECHNICAL DATA

	41243/800	41243/810
MAIN POWER	220V ac	220V ac
SUPPLY	50/60Hz	50/60Hz
MOTOR	24 Vdc	24 Vdc
POWER SUPPLY		
TRACTION FORCE	800 N	1200 N
MAX. SHEET DIMENSION	10-12 m ²	14-18 m ²
WEIGHT KIT	5 kg	5 kg

OPERATOR DIMENSIONS



Dimensions mm		
Width	height	Depth
218	365	125

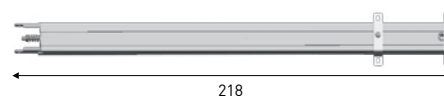

KIT 41243/800: **279,00** euro

KIT 41243/810: **353,00** euro

ITEM NUMBER	DESCRIPTION	Pcs.
41243/800	MATIC-BOX 800 Operator with on-board unit and 433.92 MHz radio receiver, nr.2 TM4 four channel transmitter (guide NOT included -see "Guides completing the kit and accessories)	1
41243/810	MATIC-BOX 1200 Operator with on-board unit and 433.92 MHz radio receiver, nr.2 TM4 four channel transmitter (guide NOT included -see "Guides completing the kit and accessories)	1
41905/004	TM4 - 433.92 MHz four-channel transmitter	2

Aprimatic signal panel



ITEM NUMBER	GUIDES COMPLETING THE KIT AND ACCESSORIES	€
41241/056	Adapter arm for counterweight-balanced up-and-over doors	185,46
41243/058	3m Belt drive rail 2part (2pcsx1.65m)	78,00
41243/059	3.90m Belt drive rail 3 part (3pcs x 1.30m)	88,00
41840/006	ET2N - 24V Led flashing light	42,30
41812/008	ER12-24V Pair of photocells	71,16

NOTE: For the available safety and signalling devices and for installation accessories, see section "Control units and indicators" in this catalogue (refer to the initial index).

NOTE: All prices are subject to variation.



02. SWING GATES

RAIDER 2500
AP424
AP423
AP350
FLEXI300
FORTY 270-390
TWENTY 270
EM73N
ZT70
ZT71





SWING GATES

TYPES

EXTERNAL MOUNTING Linear operators

Simple installation with brackets secured to the gate. The most widespread among swing gate automation systems.



Electromechanical
RAIDER 2500
AP424
AP423
AP350

Hydraulic
TWENTY 270
FORTY 270-390

EXTERNAL MOUNTING Articulated arm operators

When the traditional external gear motor cannot be installed due to lack of space.



Electromechanical
FLEXI 300

UNDERGROUND MOUNTING

It is virtually invisible and does not affect the gate design style. It does not limit the passage's clear width.



Electromechanical
EM 73 N

Hydraulic
ZT 70
ZT 71



TYPICAL SYSTEM COMPOSITION

- 1) Operator: device allowing, with an external power supply, to move a gate.
- 2) Control unit: electronic unit for handling the operator movement.
- 3) Transmitter: wireless equipment that transmits information to the control unit.
- 4) Antenna: device that increases the reception of the signals sent by the transmitter.
- 5) Flashing light: light signalling that the gate is moving.
- 6) Pair of photocells: safety devices stopping gate movement if an obstacle is detected.
- 7) Control unit: it allows activation of gate movement through a mechanical or electronic key.
- 8) Electric lock: to be included based on gate wing width.

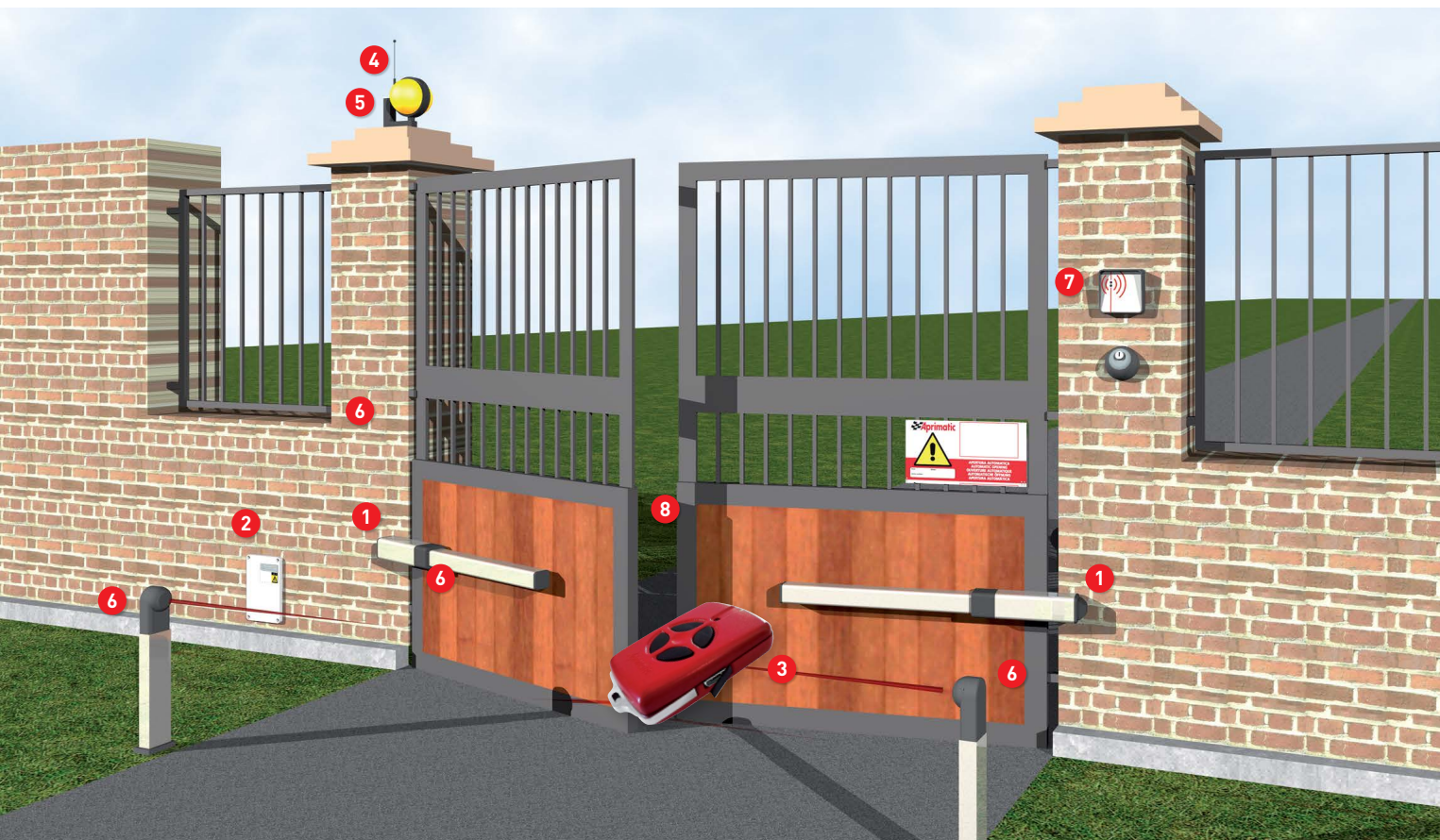

EUROPEAN STANDARDS

Standards **EN 12453** and **EN 12445** set out the minimum safety parameters. For automatic closing systems whose operation involves persons. These standards allow the identification of the necessary technical measures aimed at ensuring the safety of users and facilities.

Classification criteria include the position of the system, the type of user and the control mode.



THE SYSTEM can be:

a system can be found in a delimited **private area**, in a **private area which adjoins a public area** or in a completely **public area**.



THE USER can be:

a user is **not instructed** when he/she has not received the necessary information to operate the automation system; this generally happens for automation systems found in public areas. For automation systems in private areas, instead, the user is usually **instructed**.



THE CONTROL can be:

the system can be controlled in a number of ways: **automatic** when the pulse activates a series of operations and not a single action; **radio-controlled** if a pulse corresponds to a single operation (e.g.: opening or closing); operated by **pulses from a fixed position** if the activation of the system is possible from a single location even without automatic control reset; finally, it may lack the **self-holding** function, if the desired action lasts as long as the command activation.



MANDATORY SAFETY DEVICES

A – Operator present and control with automatic reset

B – Operator present and control with manual reset

C – Mechanical or electronic devices (you need to check the conformity of the impact forces tolerated compared to reference standards)

D – Infrared photocells to detect obstacles in the operation area

THE SCENARIO – REGULATORY REQUIREMENTS

Dispositivo di comando

		without self-holding	with pulse from a fixed position	radio control	automatic
User and type of system	private area instructed user	A	C	C	C + D
	private area not instructed user	C	C	C + D	C + D
	public area instructed user	B	C	C + D	C + D
	public area not instructed user	~	C + D	C + D	C + D

EXAMPLE OF A TYPICAL SYSTEM COMPLIANT WITH EN 12453 - EN 12445 STANDARDS

System ON A PUBLIC AREA

The system marks the boundary between a private and a public area (e.g., the driveway gate with a ramp for a condominium garage).

User INSTRUCTED

The system is activated by people having received a proper training on the automation system operation.

Safety is guaranteed by INFRARED BEAM PHOTOCELLS

Aprimatic automation systems are designed for connection of all types of infrared beam photocells, ensuring greater safety for the user.

Control RADIO

To send pulses even from a fixed position (e.g. from a desktop) or from a mobile station.



REFERENCE LAYOUT FOR SWING GATES - EXTERNAL AUTOMATION SYSTEMS









KEY

- 1 Operator
- 2 Electronic control unit
- 3 Transmitter
- 4 433.92 MHz antenna
- 5 Flashing light
- 6 Pair of photocells
- 7 Control device: key-operated switch / presence reader / keyboard combination lock / card reader / magnetic keys
- 8 Electric lock

CHOOSING THE RIGHT PRODUCT

EXTERNAL MOUNTING AUTOMATION SYSTEMS

	MODEL	USE	POWER SUPPLY	CYCLES PER DAY	WING WEIGHT	MAX. WING WIDTH	TECHNOLOGY	PAGE
	RAIDER 2500	(R)	24 Vdc	50	500 Kg	1,8 m	Electromechanical	36
					300 Kg	3,0 m*		
	AP424 AP423	(R)	24 Vdc 230 Vdc	75	300 kg	1,8 m	Electromechanical	38
	AP350	(R)	230 Vac	50	350 Kg	3 m*	Electromechanical	40
	FLEXI 300	(R)	24 Vdc	100	300 kg	3 m	Electromechanical	42
	TWENTY 270	(R) (C)	230 Vac	800		1,8 m 3,0 m*	Hydraulic	44
	FORTY 270 FORTY 390	(C) (I)	230 Vac	1000 800		2,0 m; 4,0 m* 3,0 m; 7,0 m*	Hydraulic	46

Continuously →



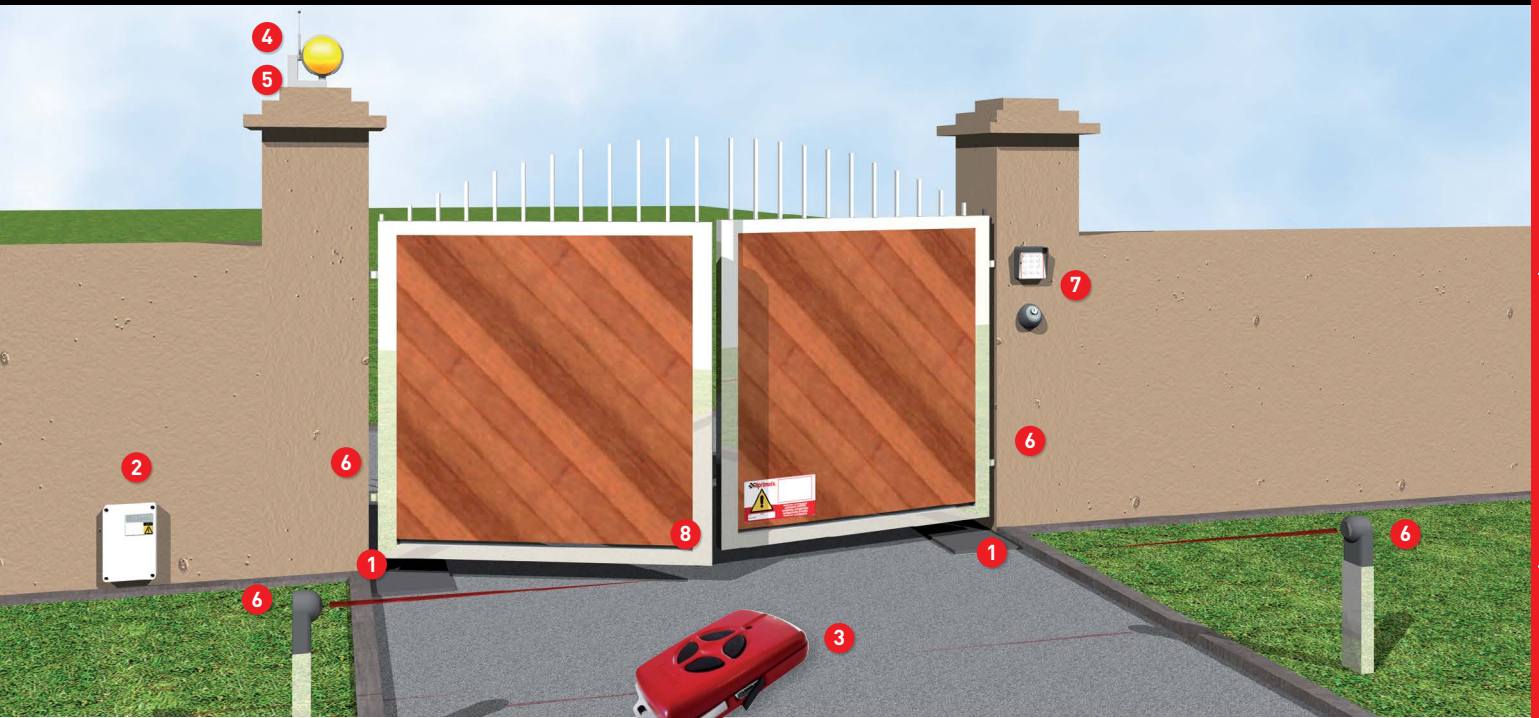

REFERENCE LAYOUT FOR SWING GATES - UNDERGROUND AUTOMATION SYSTEMS



NOTE: For equipment and control, safety and warning devices, see the optional accessories indicated for the specific operator.

NOTE: For more devices, see the section "Control units and Indicators" in this catalogue (refer to the initial index).

UNDERGROUND-MOUNTED AUTOMATION SYSTEMS

	MODEL	USE	POWER SUPPLY	CYCLES PER DAY	WING WEIGHT	MAX. WING WIDTH	TECHNOLOGY	PAGE
	EM 73 N	Ⓡ	24 Vdc	50	400 Kg	1,8 m	Electromechanical	48
					200 Kg	3,5 m*		
	ZT 70	Ⓡ	230 Vac	300	800 Kg	2,0 m	Hydraulic	50
		Ⓢ				4,0 m*		
	ZT 71	Ⓡ	230 Vac	300	800 Kg	2,0 m	Hydraulic	52
		Ⓢ				4,0 m*		

KEY Ⓡ RESIDENTIAL Ⓢ CONDOMINIUM Ⓡ INDUSTRIAL

* Electric lock needed. For product version type, see key on page 233.

NOTE: The data provided refer to correctly installed products undergoing regular maintenance.





RAIDER 2500



**Low-voltage
electromechanical
operator, for swing gates.
Residential use.**

TECHNICAL DATA

2500

MAIN POWER SUPPLY	230 Vac - 50 Hz
MOTOR POWER SUPPLY	24 Vdc
MAX. WING WIDTH WITHOUT ELECTRIC LOCK	1,8 m
MAX. WING WIDTH WITH ELECTRIC LOCK	3 m
MAX. WING WEIGHT	300 kg (for 3 m wing) 500 kg (for 1.8 m wing)
MAX. CYCLE NUMBER	50 cycles/day
PROTECTION DEGREE	IP44
ABSORBED POWER	120 W
ABSORBED CURRENT	5 A
MAX. THRUST FORCE	2500 N
ROD STROKE	400 mm
LINEAR SPEED	16 mm/s
OPERATING TEMPERATURE	-20° +70° C
ANTI-CRUSHING SAFETY	Electronic
WEIGHT OPERATOR	8 Kg



NOTE: Not compatible with previous Raider model



Full self-learning **configuration** and possibility of adjusting the parameters through a simple and intuitive menu.

Pre-drilled adjustable rear bracket.

The arms are equipped with mechanical limit stops to allow stroke adjustment. The use of an electric lock is recommended for gate wings longer than 1.8 metres.

Continuous operation guaranteed, in case of power supply failure, by two optional emergency batteries.

IDEAL INSTALLATION (1.8 M wing*)				
ITEM NUMBER	DESCRIPTION	SINGLE WING	DOUBLE WING	€
41026/001	Raider 2500	1	2	each. 238,79
41923/009	RRSE - Unico 433.92 MHz Memory System superheterodyne receiver	1	1	88,67
41600/013	RSK 24-2500 - Electronic control unit (without 433Mhz receiver)	1	1	185,46
41905/004	TM4 - 433.92 MHz four-channel transmitter	N	N	38,41
41812/008	ER12-24V - Pair of photocells	1	1	71,16
41929/001	ANT433 - 433.92 MHz antenna with 4.5 m coaxial cable and ground connection	1	1	19,12
41840/006	ET2N - 24V LED flashing light	1	1	42,30
41830/007	PC12E - Wall-mounted key-operated switch	1	1	27,81
41702/003	Battery kit (optional)	1	1	67,23

(*) For gates with wings longer than 1.8 m, it is necessary to use the electric lock.

N = Based on specific installation requirements

ITEM NUMBER	DESCRIPTION	€
41026/001	RAIDER 2500 24 V electromechanical operator including mounts and mechanical limit stops	238,79
41600/013	RSK 24-2500 Electronic control unit for RAIDER 2500 operator (without receiver), with built-in battery charging card	185,46

ITEM NUMBER	OPTIONAL ACCESSORIES	€
41702/003	Battery kit nr.2 batteries 12Vcc - 1.3Ah	67,23

SET RAIDER 2500 INTERNATIONAL: 599,23 euro

ITEM NUMBER	DESCRIPTION	Q.ty
41026/802	Set Raider 2500 International	
	RAIDER 2500	2
	RSK 24-2500 CONTROL UNIT	1

N = Based on specific installation requirements

NOTE: For the available safety and signalling devices and for installation accessories, see section "Control units and indicators" in this catalogue (refer to the initial index).

NOTE: All prices are subject to variation.

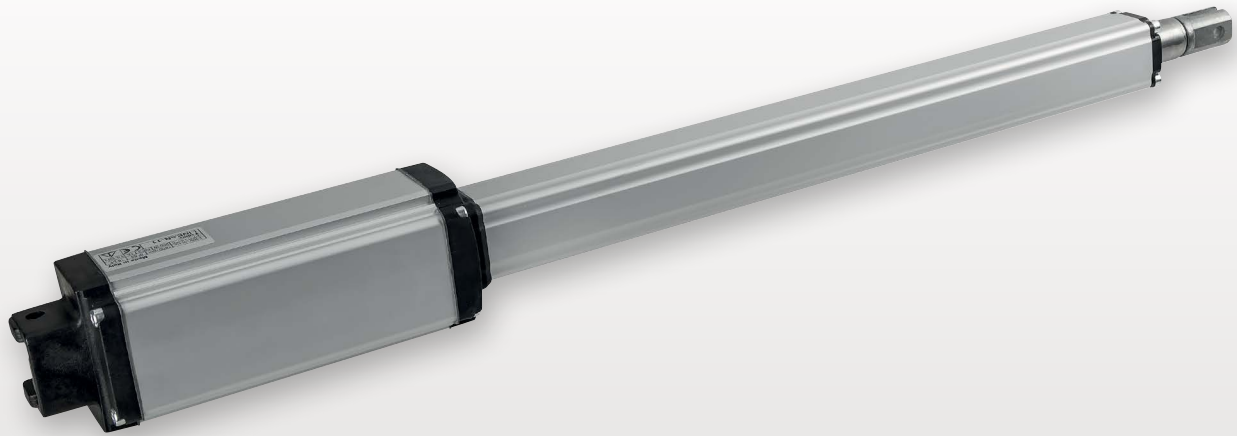

AP424 / AP423



Electromechanical operator, for swing gates.
Residential use.

TECHNICAL DATA	AP424	AP423
MAIN POWER SUPPLY	230 Vac - 50 Hz	230 Vac -50 Hz
MOTOR POWER SUPPLY	24 Vdc	230 V
MAX. WING WIDTH WITHOUT ELECTRIC LOCK	1,8 m	1.8 m
MAX. WING WIDTH WITH ELECTRIC LOCK	3 m	3 m
MAX. WING WEIGHT	300 kg (for 2 m wing) 200 kg (for 3 m wing)	300 kg (for 2 m wing) 200 kg (for 3 m wing)
MAX. CYCLE NUMBER	75 cycles/day	75 cycles/day
PROTECTION DEGREE	IP55	IP55
ABSORBED POWER	50 W	200 W
ABSORBED CURRENT	3 A	1 A
MAX. THRUST FORCE	1500N	1500N
ROD STROKE	400 mm	400 mm
LINEAR SPEED	16 mm/s	16mm/s
90° OPENING TIME	15 s	15 s
OPERATING TEMPERATURE	-20° +70° C	-20° +70°C
ANTI-CRUSHING SAFETY	Electronic	Electronic
WEIGHT OPERATOR	6,5 Kg	6,5 Kg





Elegant design suggests classic hydraulic models. Irreversible motor for a maximum power during the closing.

Multiposition brackets for easy and fast assembly. Stainless steel screw for maximum strengness and long life.

IDEAL INSTALLATION (1.8 M wing*) MODEL AP424 24V

ITEM NUMBER	DESCRIPTION	SINGLE WING	DOUBLE WING	€
41033/001	AP424 24V operator	1	2	each. 259,00
41600/013	RSK 24-2500 - Electronic control unit (without 433Mhz receiver)	1	1	185,46
41923/009	RRSE - Unico 433.92 MHz Memory System superheterodyne receiver	1	1	88,67
41905/004	TM4 - 433.92 MHz four-channel transmitter	N	N	38,41
41812/008	ER12-24V - Pair of photocells	1	1	71,16
41929/001	ANT433 - 433.92 MHz antenna with 4.5 m coaxial cable and ground connection	1	1	19,12
41840/006	ET2N - 24V LED flashing light	1	1	42,30
41830/007	PC12E - Wall-mounted key-operated switch	1	1	27,81

(*) For gates with wings longer than 1.8 m, it is necessary to use the electric lock.

N = Based on specific installation requirements

IDEAL INSTALLATION (1.8 M wing*) MODEL AP424 230V

ITEM NUMBER	DESCRIPTION	SINGLE WING	DOUBLE WING	€
41032/001	AP423 230V operator	1	2	each. 249,00
41628/001	BA230- Electronic control unit with 433.92Mhz receiver built-in	1	1	226,80
41905/004	TM4 - 433.92 MHz four-channel transmitter	N	N	38,41
41812/008	ER12-24V - Pair of photocells	1	1	71,16
41929/001	ANT433 - 433.92 MHz antenna with 4.5 m coaxial cable and ground connection	1	1	19,12
41840/006	ET2N - 24V LED flashing light	1	1	42,30
41830/007	PC12E - Wall-mounted key-operated switch	1	1	27,81

(*) For gates with wings longer than 1.8 m, it is necessary to use the electric lock.

N = Based on specific installation requirements

NOTE: For the available safety and signalling devices and for installation accessories, see section "Control units and indicators" in this catalogue (refer to the initial index).

NOTE: All prices are subject to variation.



AP 350



Operator for swing gates.
Residential use for wings
up to 3m 350Kg.

TECHNICAL DATA

POWER SUPPLY	230 Vac
MAXIMUM LENGTH PER LEAF	3 mt
MAXIMUM WEIGHT PER LEAF	350 Kg
MAX. CYCLE NUMBER	30 cycles/day
PROTECTION DEGREE	IP 44
ABSORBED POWER	280 W
ABSORBED CURRENT	1,8 A
ROD SPEED (CM/S)	1,8
USABLE STROKE	MAX 400 mm
TERMIC PROTECTION	150° C
OPERATING TEMPERATURE	-20° +70° C
CAPACITOR	8µF
MOTOR WEIGHT	6 Kg



SAFETY
LOCK / UNLOCK



Possibility to create single
- or double-wing systems

Simple installation

Easy to release in case of power blackout
Resistant to high and low temperatures

Suitable for left- and right swing leaves

Max. leaf opening 350kg length 3 mt

Rod stroke 400mm
Power supply 230Vac



Made in Italy



Safety lock / unlock

IDEAL INSTALLATION (1.8 m wing)*

ITEM NUMBER	DESCRIPTION	Q.ty	€
41035/001	Left swing gate operator AP350	1	190,22
41035/002	Right swing gate operator AP350	1	190,22
41628/001	BA230- Electronic control unit with 433.92Mhz receiver built-in	1	226,80
41905/004	TM4 433.92MHz four channel transmitter	N	38,41
41840/006	ET2N - 24V LED flashing light	1	42,30
41812/008	ER12-24V Pair of photocells	1	71,16
41929/001	ATN433 MHz antenna with 5mt coaxial cable and ground connection	1	19,12
41830/007	PC12E - Wall-mounted key-operated switch	1	27,81

(*) For gates with wings longer than 1.8 m, it is necessary to use the electric lock.

N: Based on specific installation requirements.

ITEM NUMBER	DESCRIPTION	Q.ty	€
41035/001	Left swing gate operator AP350	1	190,22
41035/002	Right swing gate operator AP350	1	190,22
41628/001	BA230- Electronic control unit with 433.92Mhz receiver built-in	1	226,80

NOTE: For the available safety and signalling devices and for installation accessories, see section "Control units and indicators" in this catalogue (refer to the initial index).

NOTE: All prices are subject to variation.



FLEXI 300

24
Vcc

300
kg



i209

**Low-voltage
electromechanical
articulated arm, for swing
gates for residential use.**

TECHNICAL DATA

MAIN POWER SUPPLY	230 Vac - 50 Hz
MOTOR POWER SUPPLY	24 Vdc
MAX. WING WIDTH	3 m without electric lock
MAX. WING WEIGHT	300 kg
PROTECTION DEGREE	IP44
ABSORBED POWER	45 W per motor
ABSORBED CURRENT	1,87 A per motor
MAXIMUM TORQUE	150 Nm
MAX. OPENING ANGLE	120°
OPERATING TEMPERATURE RANGE	-20° +55° C
ANTI-CRUSHING SAFETY	Electronic
WEIGHT OPERATOR	7 Kg





On-board control unit with full self-learning configuration.

Articulated arm fitted with mechanical limit stop, to adjust the desired stroke and prevent negative angle positioning.

Emergency release positioned on the side of the operator with customised key. It can be remotized to allow the release from the outside.

Optional 24 V battery kit for automation operation in case of power supply failure. It can drive wings with a maximum length of 3 m (without electric lock).

[*] Based on specific installation requirements.

IDEAL INSTALLATION (max. 3 m wing)*

ITEM NUMBER	DESCRIPTION	SINGLE WING	€
41029/001	FLEXI 300 OPERATOR Electromechanical operator with on-board control unit and 433.92 MHz radio receiver	1	734,33
41029/054	ARTICULATED ARM	1	83,46
41905/004	TM4 - 433.92 MHz four-channel transmitter	N	38,41
41812/008	ER12-24V - Pair of photocells	1	71,16
41929/001	ANT433 - 433.92 MHz antenna with 4.5 m coaxial cable and ground connection	1	19,12
41840/006	ET2N - 24 V LED flashing light	1	42,30
41830/007	PC12E - Wall-mounted key-operated switch	1	27,81

NOTE: For DOUBLE WING installation, use kit 41029/800.

N: Based on specific installation requirements.

ITEM NUMBER	DESCRIPTION	€
41029/001	FLEXI 300 Electromechanical operator with on-board control unit and 433.92 MHz radio receiver	734,33
41029/054	Articulated arm for FLEXI operator	83,46

ITEM NUMBER	OPTIONAL ACCESSORIES	€
41029/050	FLEXI limit stop kit	16,80
41029/053	ELC FLEXI - Optional card for electric lock and courtesy light management	67,80

NOTE: For the available safety and signalling devices and for installation accessories, see section "Control units and indicators" in this catalogue (refer to the initial index).

NOTE: All prices are subject to variation.



044

EXTERNAL CLOSING SYSTEMS

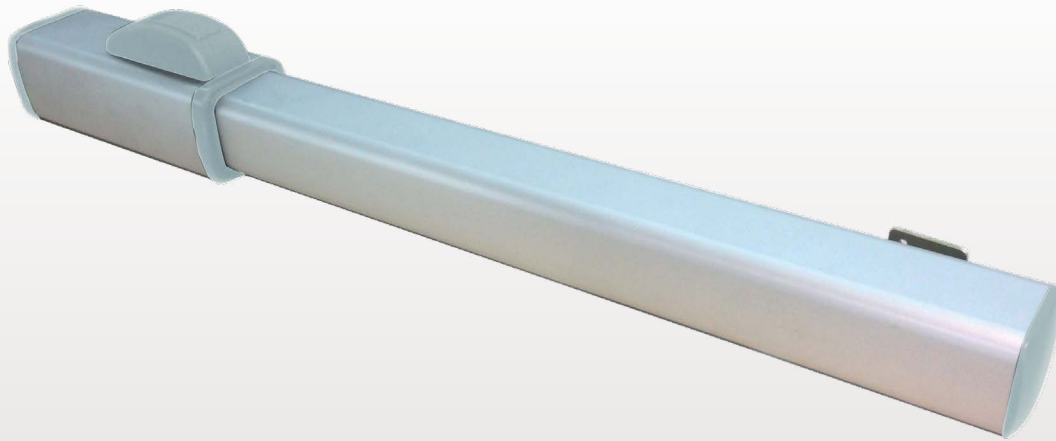

TWENTY 270



Hydraulic swing gate operators. For condominium and intensive use.

TECHNICAL DATA

TWENTY 270

MAIN POWER SUPPLY	230 V - 50 Hz
ABSORBED POWER	250 W
MAX. WING WIDTH WITHOUT ELECTRIC LOCK	1.8 m
MAX. WING WIDTH WITH ELECTRIC LOCK	3 m
MAX. CYCLE NUMBER	800 cycles/day
PROTECTION DEGREE	IP55
MAX. THRUST FORCE	5500N
VERSIONS	B - C - SF
SLOWDOWN ON CLOSING	Yes (electronically adjustable)
SLOWDOWN ON CLOSING AND OPENING	NO
LINEAR SPEED	1.3 cm/s
OPERATING TEMPERATURE	-20° +70° C
ROD STROKE	270 mm
WEIGHT OPERATOR	9.8 kg



UNIBALL MOUNT



Simple and linear design with a compatible aesthetics for all types of gates.

The slowing down system in the closing (adjustable by control unit) allows a soft approach of the wings, silently and without mechanical stress to the structure; The slowing down can be electronically adjustable.

It equipped with front hitch ball joint uniball threaded 20mm, like the previous range ZT4-ZT44, which allows to retrieve any tolerances during the fixing.

IDEAL INSTALLATION

ITEM NUMBER	DESCRIPTION	SINGLE WING	DOUBLE WING	€
41012/001	TWENTY (choose the version in the list of available models)	1	2	each. 499,00
41605/802	ESB 433- 433.92MHz swing gate Elettrosset	1	1	418,71
	BA230 electronic control unit with 433MHz built-in radio receiver	Item numbers included in the Elettrosset		
	433.92MHz antenna kit			41628/001
	Two TM4 - 433.92MHz four-channel Transmitters			41929/003
	ET2N 24V led flashing light			41905/004
	ER12-24V - Pair of photocells			41840/006
	PC12E - Wall-mounted key-operated switch			41812/008
	Signal panel			41830/007

ITEM NUMBER	DESCRIPTION	Max.wing width without electric lock	Max.wing width with electric lock	€
41012/001	TWENTY 270 B Hydraulic operator - locks on opening and closing	1.8 m	3 m	499,00
41012/002	TWENTY 270 C Hydraulic operator - locks on closing	1.8 m	3 m	499,00
41012/003	TWENTY 270 SF Hydraulic operator - without lock	-	3 m	499,00
41628/001	BA230 electronic control unit with 433MHz built-in radio receiver			226,80

The slowing down opening and closing, is adjustable on all operators by control unit. SF versions, without hydraulic lock, always require the use of the electric lock.

NOTE: For the available safety and signalling devices and for installation accessories, see section "Control units and indicators" in this catalogue (refer to the initial index).

NOTE: All prices are subject to variation.



046

EXTERNAL CLOSING SYSTEMS

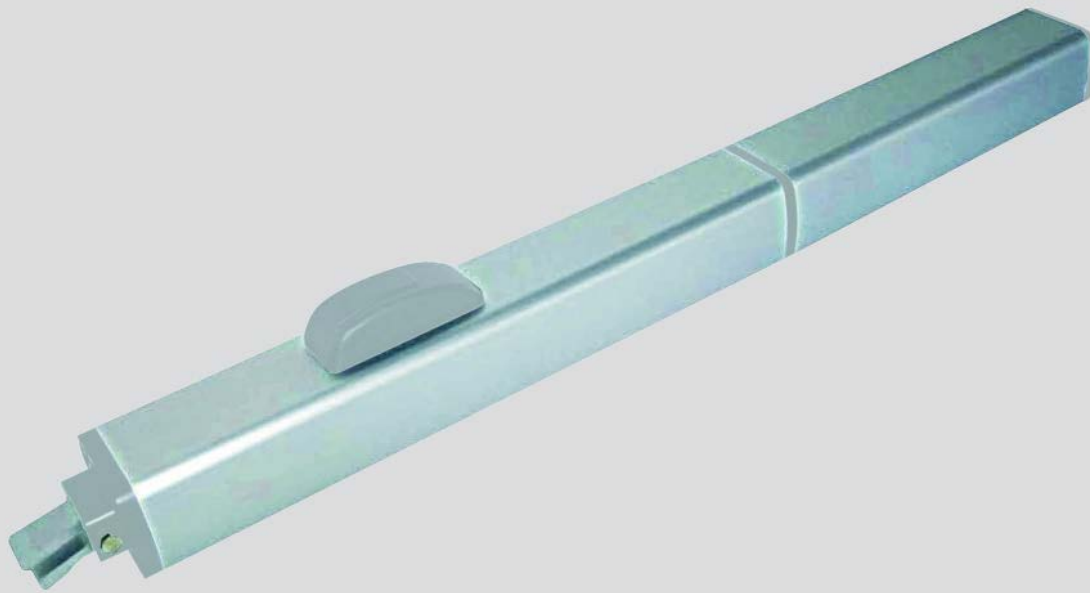

FORTY 270-390

NEW**i210**

Hydraulic swing gate operators. For residential, condominium and intensive use.

TECHNICAL DATA	FORTY 270	FORTY 390
MAIN POWER SUPPLY	230 V - 50 Hz	230 V - 50 Hz
ABSORBED POWER	250 W	350 W
MAX THRUST FORCE	6700 N	7800 N
MAX. WING WIDTH WITHOUT ELECTRIC LOCK	2 m	3 m
MAX. WING WIDTH WITH ELECTRIC LOCK	4 m	7 m
MAX. CYCLE NUMBER	1000 cycles/day	800 cycles/day
PROTECTION DEGREE	IP55	IP55
VERSIONS	B - C - SF	B - C - SF
SLOWDOWN ON CLOSING	yes - electronically adjustable	yes - electronically adjustable
LINEAR SPEED	1.3 cm/s	1.3 cm/s
OPERATING TEMPERATURE	-25° +70° C	-20° +70° C
ROD STROKE	270 mm	390 mm
WEIGHT OPERATOR	13 kg	13 kg



UNIBALL MOUNT

Simple and linear design with a compatible aesthetics for all types of gates.

The standard hydraulic slowing down system in the closing (non-adjustable) allows a soft approach of the wings, silently and without mechanical stress to the structure; The slowing down can be electronically adjustable.

It equipped with front hitch ball joint uniball threaded 20mm, like the previous range ZT40, which allows to retrieve any tolerances during the fixing.

IDEAL INSTALLATION

ITEM NUMBER	DESCRIPTION	SINGLE WING	DOUBLE WING	€
41013/001	FORTY (choose the version in the list of available models)	1	2	each. 679,00
41605/802	ESB 433- 433.92MHz swing gate Elettroset	1	1	418,71
	BA230 electronic control unit with 433MHz built-in radio receiver	Item numbers included in the Elettroset		
	433.92MHz antenna kit	41929/003		
	Two TM4 - 433.92MHz four-channel Transmitters	41905/004		
	ET2N 24V led flashing light	41840/006		
	ER12-24V - Pair of photocells	41812/008		
	PC12E - Wall-mounted key-operated switch	41830/007		
	Signal panel			

ITEM NUMBER	DESCRIPTION	Max.wing width without electric lock	Max.wing width with electric lock	€
41013/001	FORTY 270 B Hydraulic operator - locks on opening and closing	2 m	4 m	679,00
41013/002	FORTY 270 C Hydraulic operator - locks on closing	2 m	4 m	675,00
41013/003	FORTY 270 SF Hydraulic operator - without lock	-	4 m	671,00
41013/004	FORTY 390 B Hydraulic operator - locks on opening and closing	3 m	7 m	799,00
41013/005	FORTY 390 C Hydraulic operator - locks on closing	3 m	7 m	795,00
41013/006	FORTY 390 SF Hydraulic operator - without lock	-	7 m	791,00
41628/001	BA230 electronic control unit with 433MHz built-in radio receiver			226,80

NOTE : All operators are equipped with hydraulic slowing down in the closing system fix (but electronically adjustable).

NOTE : The Forty B-C operator can also be used with wings longer than 2.0 m, but in that case the electric locks is required. SF versions, without hydraulic lock, always require the use of the electric lock.

NOTE: For the available safety and signalling devices and for installation accessories, see section "Control units and indicators" in this catalogue (refer to the initial index).

NOTE: All prices are subject to variation.



048

EXTERNAL CLOSING SYSTEMS



EM 73N

24
Vcc



400
kg

i211

**Underground
electromechanical
operator for swing gates.
Residential use.**

TECHNICAL DATA

MAIN POWER SUPPLY	230 V - 50 Hz
MOTOR POWER SUPPLY	24 Vcc
WING OPENING ANGLE	110°, 140°, 180°
WIDTH / WEIGHT	1,8 m / 400 kg 3,5 m / 200 kg*
PROTECTION DEGREE	IP67
ABSORBED POWER	200 W
ABSORBED CURRENT	10 A
NOMINAL TORQUE	280 Nm
OPERATING TEMPERATURE	-20° +70° C
110° OPENING TIME	20 s
SLOWDOWN	Optional
WEIGHT OPERATOR	9 Kg



(*) It is necessary to use the electric lock with wings longer than 1.8 m.



The underground system is not visible, and is ideal for those who do not wish to alter the gate design style.

Maximum safety thanks to the 24 V power supply voltage.

Anti-crushing safety ensured by a simple adjustment of the T4 POWER electronic control unit. Cathaphoresis-coated sheet metal.

self-supporting container.

System of levers with anti-corrosion electro-plating. 110° gate opening.

EM 73N can be equipped with a separate lever system that enables opening up to 140° or a chain pinion system for opening up to 180°.

The application of an optional slowdown system allows the EM 73N to let the doors perform a fast movement during the stroke, and a soft approach on opening and closing, thus eliminating noisy impacts and rebounds.

For greater safety of operation, a manual emergency release device (SB73) is available upon request. A customised key-operated lock prevents accidental actuation of the wing's emergency release pedal. The lock can be activated from both inside and outside the gate.

IDEAL INSTALLATION (max. 2 m wing)

ITEM NUMBER	DESCRIPTION	SINGLE WING	DOUBLE WING	€
41060/001	EM 73N Operator	1	2	353,54
41060/051	CIA 173 - 400 kg underground self-supporting box	1	2	206,90
41060/052	SB73 - Release lock	1	2	73,54
41600/001	T4 Power - Electronic control unit	1	1	249,72
41923/009	RR SE - Unico 433.92 MHz Memory System superheterodyne receiver	1	1	88,67
41700/801	EKK 24V - Elettrokit	Item numbers included in the Elettrokit		237,61
	433.92 MHz antenna kit	41929/003		
	Two TM4 - 433.92 MHz four-channel transmitters	41905/004		
	ET2N - 24V LED flashing light	41840/006		
	ER12-24V - Pair of photocells	41812/008		
	PC12E - Wall-mounted key-operated switch	41830/007		
	Signal panel			
41060/050	SAC - Gate wing mounting bracket	1	2	8,67
41060/055	1 st wing slowdown kit	1	1	83,33
41060/056	2 nd wing slowdown kit	~	1	37,89

ITEM NUMBER	DESCRIPTION	€
41060/001	EM 73N - 24 V underground, self-locking electromechanical operator	353,54
41060/051	CIA 173 - Underground self-supporting box	206,90
41600/001	T4 POWER - Electronic control unit	249,72

ITEM NUMBER	OPTIONAL ACCESSORIES	€
41020/054	SCB - Buffer battery charging card. To charge buffer batteries up to 4.5 A, for use with T4 PRO and T4 POWER units	31,03
41060/050	SAC - Gate wing mounting bracket	8,67
41060/052	SB73 - Release lock	73,54
41060/055	1st wing slowdown kit	83,33
41060/056	2nd wing slowdown kit	37,89
41060/053	LE140 - Lever-operated unit for opening up to 140°	70,70
41060/054	LE180 - Chain-operated unit for opening up to 180°	171,59

NOTE: On two-wing gates, the slowdown function requires 1 slowdown kit for the 1st wing and 1 slowdown kit for the 2nd wing if the T4 POWER electronic control unit is used. On single-wing gates, the slowdown function requires 1 slowdown kit for the 1st wing if the T4POWER electronic control unit is used.

NOTE: For the available safety and signalling devices and for installation accessories, see section "Control units and indicators" in this catalogue (refer to the initial index).

NOTE: All prices are subject to variation.



ZT 70



**Underground swing
gate hydraulic operator.
Residential and
condominium use.**

HYDRAULIC CONTROL UNIT ZT 70	B4	B5	SF4	SF5
SINGLE-PHASE POWER SUPPLY	230 V - 50 Hz			
ABSORBED POWER	250 W			
MAX. WING WIDTH (m)	2,0	2,0	4,0	4,0
PUMP CAPACITY (Lt/min)	0,6	0,75	0,6	0,75
PROTECTION DEGREE	IP54			
OPERATING TEMPERATURE	-20° +70° C			
MAX. OPERATING PRESSURE	40 Bar			
OIL QUANTITY	1 Lt			
OIL TYPE	AprimOil			
WEIGHT WITH OIL	5 kg			

JACK	AT 175	AT 176
MAX. USEFUL OPERATING ANGLE	110°	200°
MAX. WING WEIGHT	800 kg	800 kg
PROTECTION DEGREE	IP67	IP67
ANGULAR PUMP SPEED FROM 0.6 Lt/min.	6°/s	6°/s
ANGULAR PUMP SPEED FROM 0.75 Lt/min.	7°/s	7°/s
NOMINAL TORQUE	410 Nm	410 Nm
OIL QUANTITY	1 Lt	1,2 Lt
OIL TYPE	AprimOil	AprimOil
WEIGHT WITH OIL	12 kg	13 kg



Very low noise levels thanks to the hydraulic brake used to slow down the gate during opening and closing, thus preventing rebounds and noisy impacts.

The automation is located underground and therefore does not affect the design style of the gate.

The anti-crushing system consists of very sensitive bypass valves, calibrated during installation. They immediately cut the hydraulic pressure when an obstacle is detected, to ensure maximum system safety.

The system features an easy-maintenance self-supporting box. The jack is accessed by removing the stainless steel cover without removing the gate wing.

An easy-to-use manual release device ensures gate operation **in the event of power supply failure.**

IDEAL INSTALLATION (max. 2 m wing)

ITEM NUMBER	DESCRIZIONE	SINGLE WING	DOUBLE WING	€
41050/003	AT 175N - Hydraulic jack	1	2	388,32
41055/003	ZT 70B5 - Hydraulic control unit	1	2	450,34
41005/050	CIA 170 - 800 kg underground self-supporting box	1	2	179,05
41056/054	TF - 10 m hose for ZT70	1	1	45,79
41056/055	RAC - Pair of TF hose couplings	1	2	23,17
41700/016	AprimOil (1 litre bottle)	1	1	16,96
41605/802	ESB 433 - 433.92 MHz swing gate Elettrosset	1	1	418,71
	BA230 electronic control unit with 433Mhz built-in radio receiver			41628/001
	433.92 MHz antenna kit			41929/003
	Two TM4 - 433.92 MHz four-channel transmitters			41905/004
	ET2N - 24V LED flashing light			41840/006
	ER12-24V - Pair of photocells			41812/008
	PC12E - Wall-mounted key-operated switch			41830/007
	Signal panel			
ITEM NUMBER	DESCRIPTION - HYDRAULIC CONTROL UNIT			€
41055/003	ZT 70 B5 Hydraulic control unit with metal box - lock on opening and closing			450,34
41055/001	ZT 70 SF5 Hydraulic control unit with metal box, without hydraulic lock, electric lock required			410,92
ITEM NUMBER	DESCRIPTION - JACK			€
41050/003	AT 175N Single hydraulic jack for use without self-supporting box (41005/050). Adjustable slowdown during opening and closing			388,32
41051/002	AT 176N single hydraulic jack for use without self-supporting box. Adjustable slowdown during opening and closing			431,22
41050/002	AT 175 Hydraulic jack with metal box and stainless steel lid. Adjustable slowdown during opening and closing			452,65
41051/001	AT 176 Hydraulic jack with metal box and stainless steel lid. Adjustable slowdown during opening and closing			501,92
41005/050	CIA 170 Underground self-supporting box complete with installation accessories and stainless steel lid			179,05
41050/050	PF 70 Foundation plate for AT 175, AT176 (cataphoresis coated)			27,17
ITEM NUMBER	DESCRIPTION - EQUIPMENT			€
41628/001	BA230 electronic control unit with 433.92 MHz built-in radio receiver			226,80
ITEM NUMBER	OPTIONAL ACCESSORIES			€
41700/016	AprimOil (1 litre bottle)			16,96
41056/056	TRA - Copper pipe with 8 mm ext. Ø (to be ordered in the desired length)			6,36

NOTE: For the available safety and signalling devices and for installation accessories, see section "Control units and indicators" in this catalogue (refer to the initial index).

NOTE: All prices are subject to variation.



ZT 71



Compact underground hydraulic operator for swing gates. Residential and condominium use.

CONTROL UNIT	B5	SF5
SINGLE-PHASE POWER SUPPLY	230 V-50 Hz	
MAX. WING WIDTH (m)	2,0	4,0
PROTECTION DEGREE	IP54	
ABSORBED POWER	250 W	
OPERATING TEMP.	-20°+70° C	
PUMP CAPACITY (Lt/min)	0,75	0,75
MAX. OPERATING PRESSURE	40 Bar	
OIL TYPE	AprimOil	
WEIGHT WITH OIL	5 kg	
OIL QUANTITY	1 Lt	

JACK	
USEFUL OPERATING ANGLE	110° max.
MAX. WING WEIGHT	800 kg
ANGULAR PUMP SPEED FROM 0.6 Lt/min.	6°/s
ANGULAR PUMP SPEED FROM 0.75 Lt/min.	7°/s
NOMINAL TORQUE	410 Nm
WEIGHT WITH OIL	12 kg
OIL QUANTITY	1 Lt
OIL TYPE	AprimOil



Very low noise levels thanks to the hydraulic brake to slowdown the gate during opening and closing, thus preventing rebound and noisy impacts.

The automation is located underground, and therefore does not affect the design style of the gate.

The anti-crushing system consists of very sensitive bypass valves, calibrated during installation. They immediately cut the hydraulic pressure when an obstacle is detected to ensure maximum system safety.

The system features an easy-maintenance self-supporting box. The jack is accessed

by removing the stainless steel cover without removing the gate wing.

An easy-to-use manual release device ensures gate operation **in the event of a power supply failure.**

(*) Product certified under ideal installation conditions.

IDEAL INSTALLATION (max. 2 m wing)

ITEM NUMBER	DESCRIPTION	SINGLE WING	DOUBLE WING	€
41056/002	ZT 71 B5 - (ZT 70 B5 control unit + AT 175N jack)	1	2	849,10
41056/051	CIA 171 - 800 kg Underground self-supporting box	1	2	176,75
41605/802	ESB 433 - 433.92 MHz swing gate Elettroset	1	1	418,71
	BA230 electronic control unit with 433Mhz built-in radio receiver	Item numbers included in the Kit		
	433.92 MHz antenna kit	41628/001		
	Two TM4 - 433.92 MHz four-channel transmitters	41929/003		
	ET2N - 24V LED flashing light	41905/004		
	ER12-24V - Pair of photocells	41840/006		
	PC12E - Wall-mounted key-operated switch	41812/008		
	Signal panel	41830/007		

ITEM NUMBER	DESCRIPTION	€
41056/002	ZT 71B5 (ZT 70B5 control unit + AT 175N jack) Double hydraulic lock with adjustable slowdown on opening and closing	849,10
41056/004	ZT 71SF5 (ZT 70SF5 control unit + AT 175N jack) Without hydraulic lock, adjustable slowdown on opening and closing	824,18
41056/051	CIA 171 Self-supporting box complete with installation accessories and stainless steel lid	176,75

NOTE: All compact hydraulic operators contain the SED 71/72 direct external release device

ITEM NUMBER	OPTIONAL ACCESSORIES	€
41056/052	SED 71/72 - Direct external release (provided as standard with all ZT operators)	15,63
41056/053	SER 71/72 - Driven external release ZT 71 ZT 72	35,93
41704/002	CS - External strongbox, for driven release	74,19
41704/004	CSP - Wall mounted outdoor strongbox	61,43
41700/016	AprimOil 1 litre bottle	16,96

NOTE: For the available safety and signalling devices and for installation accessories, see section "Control units and indicators" in this catalogue (refer to the initial index).

NOTE: All prices are subject to variation.

03.

SLIDING GATES

ONDA 424
ONDA 624
ONDA 623
ONDA 800 / 801E
AT 80E
ONDA 2000 / 2001
AT 86T / AT 88T
AT 90T / AT 92T



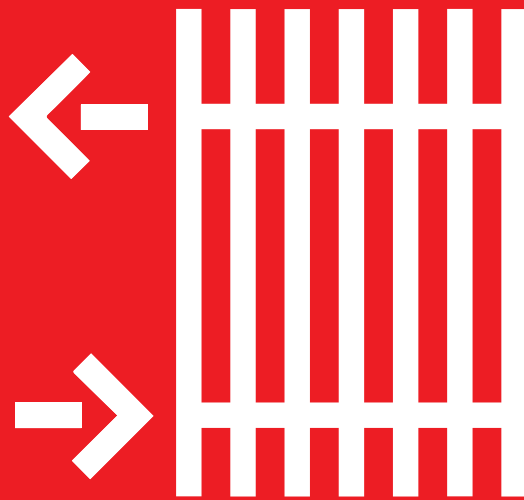

03. Sliding gates



SLIDING GATES

TYPES

RESIDENTIAL USE

A wide range of motors for residential use is available, for light wings up to 400 kg and heavy wings up to 1,200 kg, for the installation of "custom-made" systems.

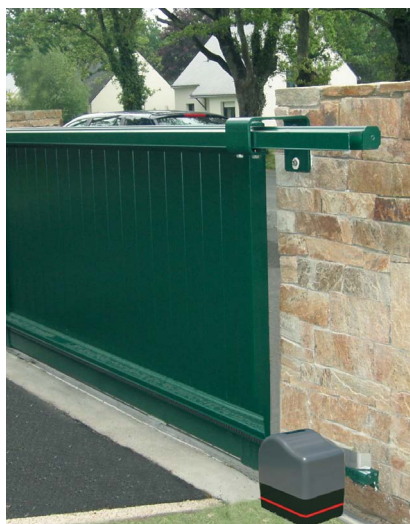

24V version
ONDA 424
ONDA 624

230V version
ONDA 623
ONDA 800
AT 80 E

CONDOMINIUM USE

The following motors for condominium use are available: for light wings of 300 kg and heavy wings up to 2,000 kg.

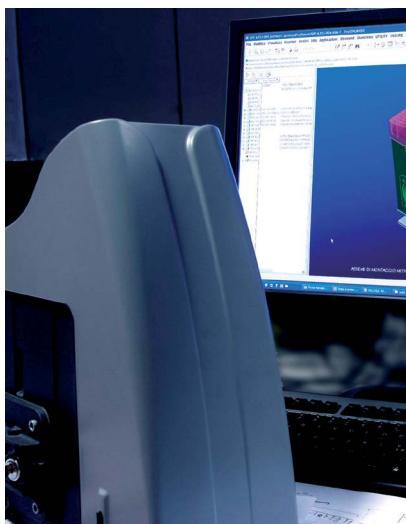

24V version
ONDA 624

230V version
ONDA 623
ONDA 801 E
AT 80 E
ONDA 2000

INDUSTRIAL USE

For industrial use, it is possible to automate heavy gates for large entrances (as in the case of shopping centres, factories, hospitals, etc.), with motors designed to operate gates having wings up to 12,000 kg. Designed to ensure maximum safety in operation and reliable performance over time, to withstand all weather conditions.



230V version
AT 80 E
ONDA 2000

380V version
AT 86 T
AT 88 T
AT 90 T
AT 92 T



TYPICAL SYSTEM COMPOSITION

- 1) Operator: device allowing, with an external power supply, to move a gate.
- 2) Control unit: electronic unit for handling the operator movement.
- 3) Transmitter: wireless equipment that transmits information to the control unit.
- 4) Antenna: device that increases the reception of the signals sent by the transmitter.
- 5) Flashing light: light signalling that the gate is moving.
- 6) Pair of photocells: safety devices stopping the gate movement in case of obstacles.
- 7) Control unit: it allows activation of gate movement through a mechanical or electronic key.
- 8) Safety edge: sensitive edge used to prevent the risk of crushing due to electric gate movement. In case of contact, the automation system inverts motion and prevents damage to people and property.

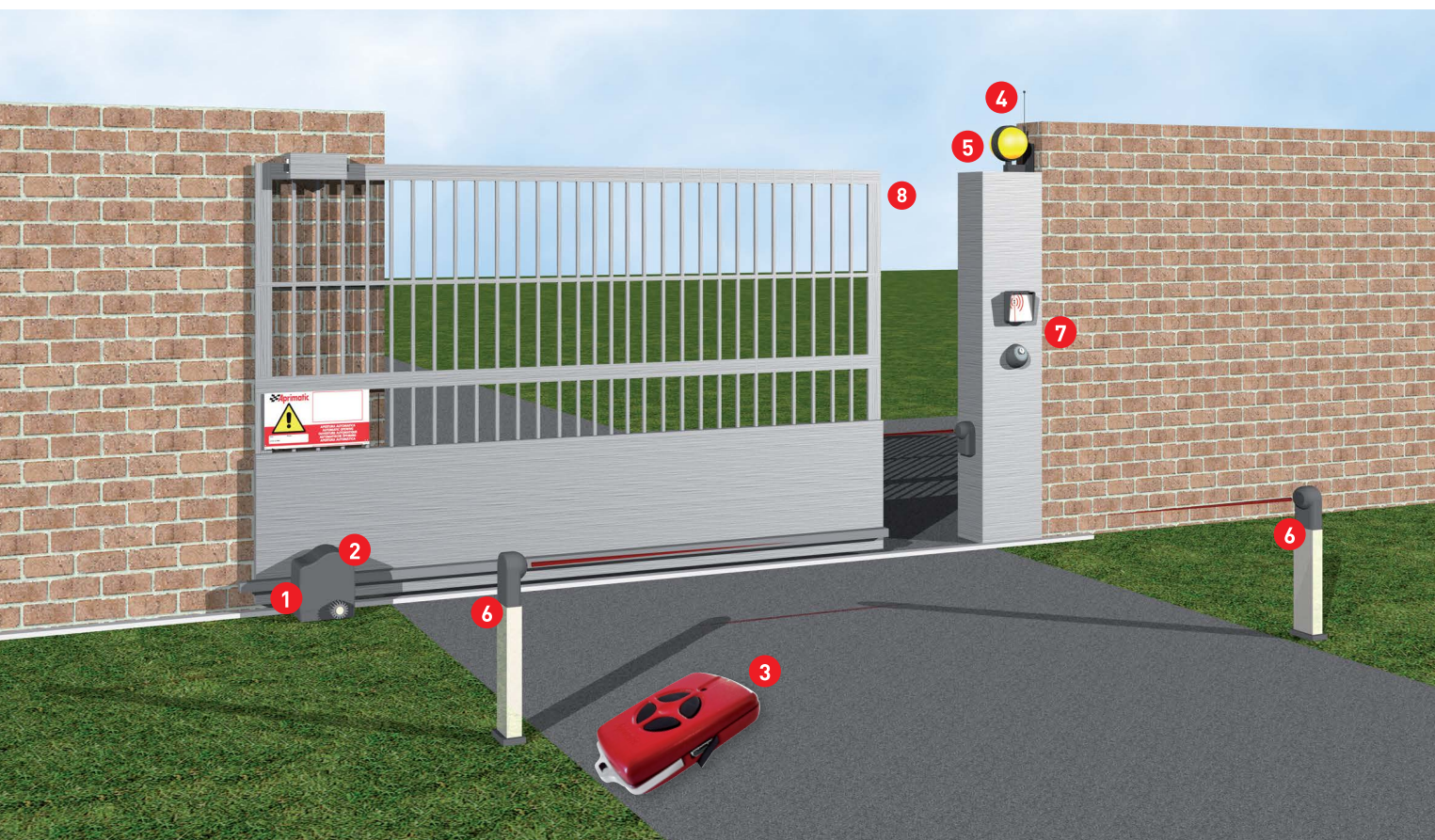

EUROPEAN STANDARDS

Standards **EN 12453** and **EN 12445** set out the minimum safety parameters. For automatic closing systems whose operation involves persons. These standards allow the identification of the necessary technical measures aimed at ensuring the safety of users and facilities.

Classification criteria include the position of the system, the type of user and the control mode.



THE SYSTEM can be:

a system can be found in a delimited **private area**, in a **private area which adjoins a public area** or in a completely **public area**.



THE USER can be:

a user is **not instructed** when he/she has not received the necessary information to operate the automation system; this generally happens for automation systems found in public areas. For automation systems in private areas, instead, the user is usually **instructed**.



THE CONTROL can be:

the system can be controlled in a number of ways: **automatic** when the pulse activates a series of operations and not a single action; **radio-controlled** if a pulse corresponds to a single operation (e.g.: opening or closing); operated by **pulses from a fixed position** if the activation of the system is possible from a single location even without automatic control reset; finally, it may lack the **self-holding** function, if the desired action lasts as long as the command activation.



MANDATORY SAFETY DEVICES

A – Operator present and control with automatic reset

B – Operator present and control with manual reset

C – Mechanical or electronic devices (you need to check the conformity of the impact forces tolerated compared to reference standards)

D – Infrared photocells to detect obstacles in the operation area

THE SCENARIO – REGULATORY REQUIREMENTS

	Control device			
	Without self-holding	With pulse from a fixed position	Radio control	Automatic
Private area instructed user	A	C	C	C + D
Private area not instructed user	C	C	C + D	C + D
Public area instructed user	B	C	C + D	C + D
Public area not instructed user	~	C + D	C + D	C + D

Utente e tipo di impianto

EXAMPLE OF A TYPICAL SYSTEM COMPLIANT WITH EN 12453 - EN 12445 STANDARDS

System ON A PUBLIC AREA

The system marks the boundary between a private and a public area (e.g., the driveway gate with a ramp for a condominium garage).

User INSTRUCTED

The system is activated by people having received a proper training on the automation system operation.

Control RADIO

To send pulses even from a fixed position (e.g. desktop) or from mobile stations

Safety is guaranteed by INFRARED BEAM PHOTOCELLS

Automatic automation systems are designed for connection of all types of infrared beam photocells, ensuring greater safety for the user.

SAFETY EDGE

Sensitive edge used to prevent the risk of crushing due to electric gates movement. In case of contact, the automation system inverts motion and prevents damage to people and property.



REFERENCE LAYOUT FOR SLIDING GATE SYSTEMS

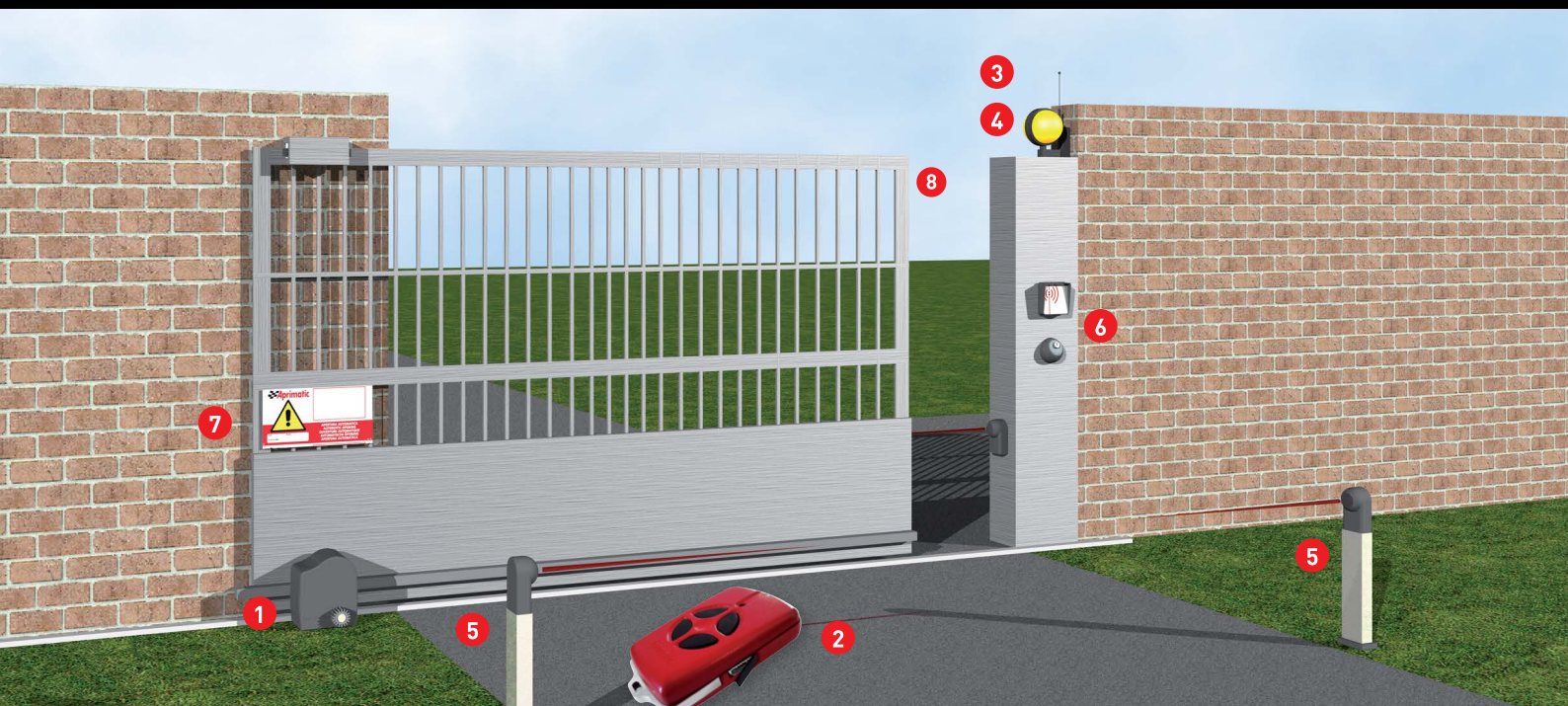







KEY

- 1 Gear motor with on-board electronic control unit and built-in radio receiver
- 2 Transmitter
- 3 433.92 MHz antenna
- 4 Flashing light
- 5 Pair of photocells
- 6 Control device
- 7 Aprimatic sign
- 8 Safety edge

CHOOSING THE RIGHT PRODUCT

EXTERNAL MOUNTING AUTOMATION SYSTEMS

	MODEL	USE	POWER SUPPLY	CYCLES DAY	MAX. WING WEIGHT	CLUTCH	PAGE
	ONDA 424	(R)	24 Vdc	100	400 kg	Electronic	62
	ONDA 624	(R) (C)	24 Vdc	100	600 kg 400 kg	Electronic	64
	ONDA 623	(R) (C)	230 Vac 230 Vac	100	600 kg 400 kg	Electronic	66
	ONDA 800 ONDA 801 E	(R) (C)	230 Vac 230Vac	100 200	800 kg 500 kg	800 Mechanical 500 Electronic	68
	AT 80 E	(R) (C) (I)	230 Vac	200 800	1200 kg 800 kg	Mechanical	70
	ONDA 2000 ONDA 2001	(C) (I)	230 Vac 230 Vac	1000 1000	2000 kg 1000 kg	2000 Mechanical 2001 Electronic	72



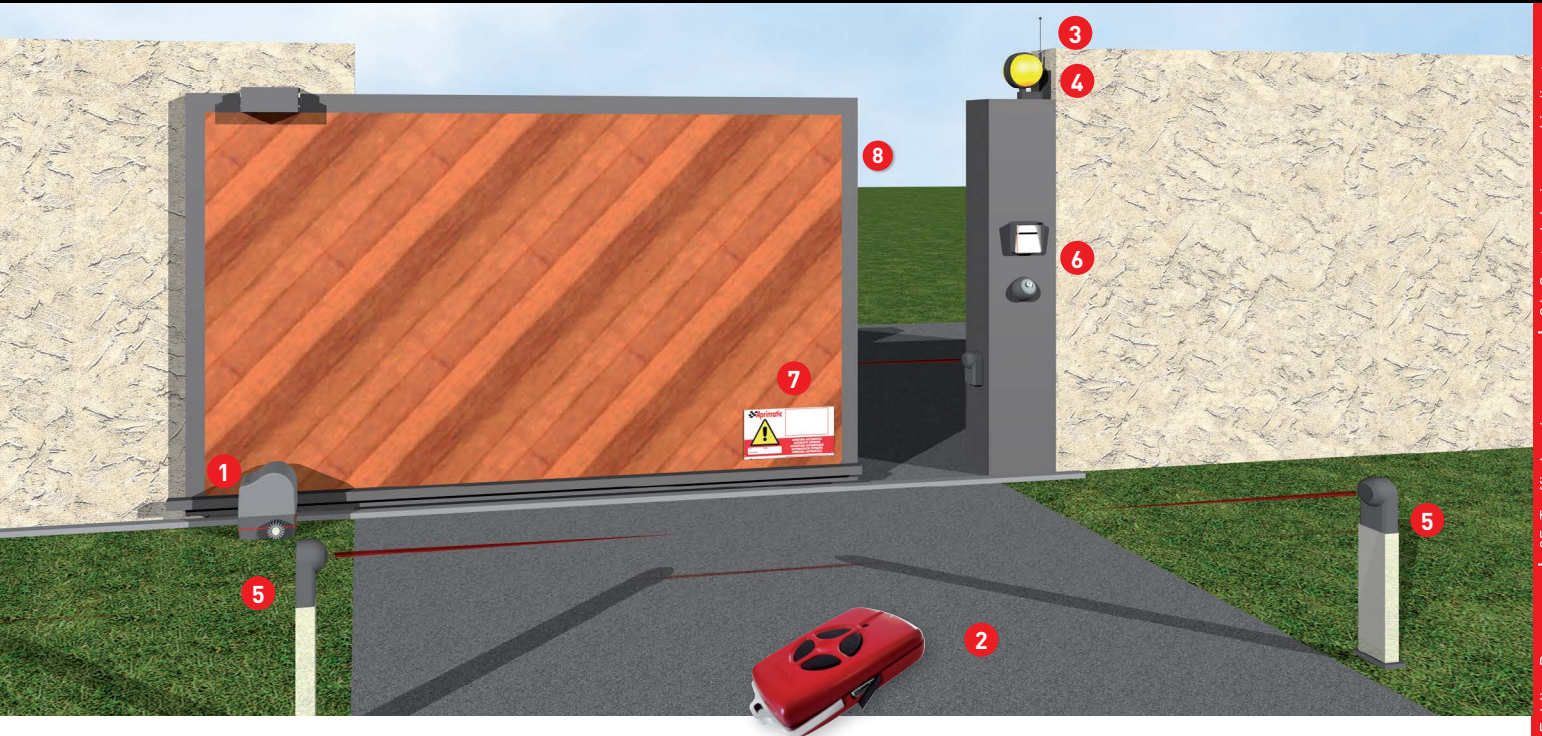

REFERENCE LAYOUT FOR SLIDING GATE SYSTEMS



NOTE: For equipment and control, safety and warning devices, see the optional accessories indicated for the specific operator.

NOTE: For more devices, see the section "Control units and Indicators" in this catalogue (refer to the initial index).

EXTERNAL MOUNTING AUTOMATION SYSTEMS

	MODEL	USE	POWER SUPPLY	CYCLES DAY	MAX. WING WEIGHT	CLUTCH	PAGE
	AT 86 T	ⓘ	380 Vac	Continuous use	2000 kg	Mechanical	74
	AT 88 T	ⓘ	380 Vac	Continuous use	4000 kg	Mechanical	
	AT 90 T	ⓘ	380 Vac	Continuous use	8000 kg	Mechanical	76
	AT 92 T	ⓘ	380 Vac	Continuous use	12000 kg	Mechanical	

KEY

Ⓡ RESIDENTIAL

Ⓒ CONDOMINIUM

ⓘ INDUSTRIAL

NOTE: The data provided refer to correctly installed products undergoing regular maintenance.



ONDA 424



Low-voltage gear motor
for sliding gates.
Residential use for wings
up to 400 kg.

TECHNICAL DATA

MAIN POWER SUPPLY	230 Vac - 50 Hz
MOTOR POWER SUPPLY	24 Vdc
MAX. WING WEIGHT	400 kg
CYCLE NUMBER	100 cycles/day
PROTECTION DEGREE	IP44
MAX. ABSORBED POWER	80 W
MAX. ABSORBED CURRENT	4.2 A
MAX. THRUST FORCE	450 N
MAX. LINEAR SPEED	10 m/min
OPERATING TEMPERATURE	-20° +55° C
HEIGHT OF PINION FROM GROUND	55 mm
WEIGHT OPERATOR	7 Kg





Complies with the current safety standards as regards to obstacle detection and inversion of movement in accordance with **EN12453** and **EN 12445 (*)**.

The electronic torque adjustment combined with encoder technology guarantees a gradual approach during opening and closing movements.

Continuity of operation guaranteed, in the event of power supply failure, by a set of optional batteries which may be fitted inside the operator casing.

Sturdy and reliable thanks to the die-cast aluminium casing.

Worm screw gear motor with aluminium body and on-board electronic control unit. Equipped with adjustable-height foundation plate.

Emergency release lever with customised key, for use during power supply failures.

(*) Product certified under ideal installation conditions.

IDEAL INSTALLATION

ITEM NUMBER	DESCRIPTION	Q.ty	€
41101/001	ONDA 424 with on-board control unit and 433Mhz receiver	1	425,41
41905/004	TM4 - 433.92 MHz four-channel transmitters	N	each. 38,41
41929/001	Ant 433 - 433.92 MHz antenna with 4.5 m coaxial cable and ground connection	1	19,12
41840/006	ET2N - 24 V LED flashing light	1	42,30
41830/007	PC12E - Wall-mounted key-operated switch	1	27,81
41812/008	ER 12-24V - Pair of photocells	1	71,16
41180/064	CP- Aprimatic 10m plastic rack with steel core and mounts module 4)	1	156,09

NOTE: Use of a safety edge is recommended; see section "Control units and Indicators".

N: Based on specific installation requirements

ITEM NUMBER	DESCRIPTION	€
41101/001	ONDA 424 with on-board control unit and receiver (rack required)	425,41

ITEM NUMBER	OPTIONAL ACCESSORIES	€
41100/050	Battery charging card	24,32
41102/050	Battery kit (no. 2 batteries of 12V - 1.3Ah)	74,19
41180/064	CP - APRIMATIC 10 m plastic rack with steel core and mounts (module 4)	156,09

NOTE: For the available safety and signalling devices and for installation accessories, see section "Control units and indicators" in this catalogue (refer to the initial index).

NOTE: All prices are subject to variation.



ONDA 624



Low-voltage gear motor for sliding gates. Residential use for wings up to 600 kg, condominium use for wings up to 400 kg.

TECHNICAL DATA

MAIN POWER SUPPLY	230 Vac - 50 Hz
MOTOR POWER SUPPLY	24 Vdc
MAX. WING WEIGHT	600 kg
CYCLE NUMBER	100 cycles/day
PROTECTION DEGREE	IP44
MAX. ABSORBED POWER	80 W
MAX. ABSORBED CURRENT	4.2 A
MAX. THRUST FORCE	650 N
MAX. LINEAR SPEED	10 m/min
OPERATING TEMPERATURE	-20° +55° C
HEIGHT OF PINION FROM GROUND	55 mm
WEIGHT OPERATOR	7 Kg





Complies with the current safety standards as regards to obstacle detection and inversion of movement in accordance with **EN12453** and **EN 12445 (*)**.

The electronic torque adjustment combined with encoder technology guarantees a gradual approach during opening and closing movements.

Continuity of operation guaranteed, in the event of power supply failure, by a set of optional batteries which may be fitted inside the operator casing.

Sturdy and reliable thanks to the die-cast aluminium casing.

Worm screw gear motor with aluminium body and on-board electronic control unit. Equipped with adjustable-height foundation plate.

Emergency release lever with customised key, for use during power supply failures.

(*) Product certified under ideal installation conditions.

IDEAL INSTALLATION

ITEM NUMBER	DESCRIPTION	Q.ty	€
41102/001	ONDA 624 with on-board control unit and 433Mhz receiver	1	508,88
41905/004	TM4 - 433.92 MHz four-channel transmitter	N	each. 38,41
41929/001	Ant 433 - 433.92 MHz antenna with 4.5 m coaxial cable and ground connection	1	19,12
41840/006	ET2N - 24 V LED flashing light	1	42,30
41830/007	PC12E - Wall-mounted key-operated switch	1	27,81
41812/008	ER 12-24V - Pair of photocells	1	71,16
41180/064	CP- Aprimatic 10m plastic rack with steel core and mounts module 4)	1	156,09

NOTE: Use of a safety edge is recommended; see section "Control units and Indicators".

N: Based on specific installation requirements

ITEM NUMBER	DESCRIPTION	€
41102/001	ONDA 624 with on-board control unit and 433Mhz receiver (rack required)	508,88

ITEM NUMBER	OPTIONAL ACCESSORIES	€
41100/050	Battery charging card	24,32
41102/050	Battery kit (no. 2 batteries of 12V - 1.3Ah)	74,19
41180/064	CP - APRIMATIC 10 m plastic rack with steel core and mounts (module 4)	156,09

NOTE: For the available safety and signalling devices and for installation accessories, see section "Control units and indicators" in this catalogue (refer to the initial index).

NOTE: All prices are subject to variation.



ONDA 623



Low-voltage gear motor for sliding gates. Residential use for wings up to 600 kg, condominium use for wings up to 400 kg.

TECHNICAL DATA

MAIN POWER SUPPLY	230 V - 50 Hz
MAX. WING WEIGHT	600 kg
CYCLE NUMBER	100 cycles/day
PROTECTION DEGREE	IP44
MAX. ABSORBED POWER	1,3 A
MAX. ABSORBED CURRENT	250 W
MAX. THRUST FORCE	650 N
MAX. LINEAR SPEED	10 m/min
OPERATING TEMPERATURE	-20° +55° C
HEIGHT OF PINION FROM GROUND	55 mm
WEIGHT OPERATOR	7 Kg





Complies with the current safety standards as regards to obstacle detection and inversion of movement in accordance with **EN12453** and **EN 12445 (*)**. The electronic torque adjustment combined with encoder technology guarantees a gradual approach during opening and closing movements.

Continuity of operation guaranteed, in the event of power supply failure, by a set of optional batteries which may be fitted inside the operator casing.

Sturdy and reliable thanks to the die-cast aluminium casing.

Worm screw gear motor with aluminium body and on-board electronic control unit. Equipped with adjustable-height foundation plate.

Emergency release lever with customised key, for use during power supply failures.

(*) Product certified under ideal installation conditions.

IDEAL INSTALLATION ONDA 623

ITEM NUMBER	DESCRIPTION	Q.ty	€
41623/001	ONDA 623 with SC230 on-board control unit and 433Mhz receiver	1	599,00
41180/064	CP- Aprimatic 10m plastic rack with steel core and mounts module 4)	1	156,09
41700/801	EKK-24V Elettrokkit	1	237,61
	433.92 MHz antenna kit	41929/003	
	Two TM4 - 433.92 MHz four-channel transmitters	41905/004	
	ET2N- 24V Led flashing light	41840/006	
	ER12-24V Pair of photocells	41812/008	
	PC12E Wall-mounted key-operated switch	41830/007	
	Signal panel		

NOTE: Use of a safety edge is recommended; see section "Control units and Indicators".

ITEM NUMBER	ACCESSORIES	€
41180/064	CP- Aprimatic 10m plastic rack with steel core and mounts module 4)	156,09
41180/063	CZ - Aprimatic 4m galvanised steel rack with mounts (module 4)	75,93

NOTE: For the available safety and signalling devices and for installation accessories, see section "Control units and indicators" in this catalogue (refer to the initial index).

NOTE: All prices are subject to variation.



ONDA 800 / 801 E



Gear motor for sliding gates,
for condominium use with
wings up to 500 kg and for
residential use with wings
up to 800 kg.

TECHNICAL DATA

MAIN POWER SUPPLY	230 V - 50 Hz
MAX. WING WEIGHT	800 kg (Z16) 500 kg (Z20)
CYCLE NUMBER	100 cycles/day
PROTECTION DEGREE	IP44
ABSORBED POWER	260 W
THRUST FORCE	1250 N (Z16) 1000 N (Z20)
MAX. LINEAR SPEED	9,5 m/min (Z16) 12,0 m/min (Z20)
OPERATING TEMPERATURE	-20° +70° C
HEIGHT OF PINION FROM GROUND	70 mm
WEIGHT OPERATOR	11 Kg





ONDA 800 - with mechanical clutch
for anti-crushing safety and preset
for integrating the control unit.

**ONDA 801E - with SC 230 on-board
control unit** and electronic clutch.

ONDA 801E / 800E - for residential gates
up to 800 kg, or condominium gates
up to 500 kg.

Self-locking worm screw gear motor
with anodised aluminium body.
Steel gears with permanent lubrication.
No electric lock required.

Equipped with a practical key release
for manual operation in the event of power
supply failure.

Z20 20-teeth pinion available
for installation in the gear motor
for applications requiring faster
automation speed.

IDEAL INSTALLATION - ONDA 800

ITEM NUMBER	DESCRIPTION	Q.ty	€
41127/029	ONDA 800 Z16 Motor with mechanical clutch	1	469,47
41180/063	CZ - APRIMATIC 4 m galvanised steel rack with mounts (module 4)	1	75,93
41615/801	ESS 433 - 433.92 MHz swing gate Elettroset	1	442,63
	SC230 control unit with 433.92MHz built-in radio receiver	Item numbers included in the kit	
	433.92 MHz antenna kit	41626/001	
	ER12-24V Pair of photocells	41929/003	
	ET2N 24V led flashing light	41812/008	
	Two TM4 - 433.92 MHz four-channel transmitters	41840/006	
	PC12E Wall-mounted key-operated switch	41905/004	
	Signal panel	41830/007	

NOTE: Use of a safety edge is recommended; see section "Control units and Indicators".

IDEAL INSTALLATION - ONDA 801E

ITEM NUMBER	DESCRIPTION	Q.ty	€
41127/023	ONDA 801 E Z16 Motor with electronic clutch and on-board SC230 electronic card with built-in 433.92 MHz receiver	1	704,79
41180/063	CZ - APRIMATIC 4 m galvanised steel rack with mounts (module 4)	1	75,93
41700/801	EKK-24V Elettrokit	1	237,61
	433.92 MHz antenna kit	Item numbers included in the kit	
	Two TM4 - 433.92 MHz four-channel transmitters	41929/003	
	ET2N- 24V Led flashing light	41905/004	
	ER12-24V Pair of photocells	41840/006	
	PC12E Wall-mounted key-operated switch	41812/008	
	Signal panel	41830/007	

NOTE: Use of a safety edge is recommended; see section "Control units and Indicators".

ITEM NUMBER	DESCRIPTION	€
41127/029	ONDA 800 Z16 (rack required) Gear motor with mechanical clutch and 16-teeth pinion, preset for the integration of SC230 control unit	469,47
41127/023	ONDA 801E Z16 (rack required) Gear motor with on-board SC230 control unit with built-in radio, electronic clutch and 16-teeth pinion	704,79

ITEM NUMBER	ACCESSORIES	€
41126/051	PF 500/800 - Foundation plate (package with 4 pieces)	each. 23,01
41180/064	CP - APRIMATIC 10 m plastic rack with steel core and mounts (module 4)	156,09
41180/063	CZ - APRIMATIC 4 m galvanised steel rack with mounts (module 4)	75,93
41127/101	Z20 - 20-teeth pinion	42,81

NOTE: For the available safety and signalling devices and for installation accessories, see section "Control units and indicators" in this catalogue (refer to the initial index).

NOTE: All prices are subject to variation.



AT 80 / AT 80 E



Sliding gate gear motor.
Intensive use for wings up
to 800 kg and residential use
for wings up to 1200 kg.

TECHNICAL DATA

MAIN POWER SUPPLY	230 V - 50 Hz
MAX. WING WEIGHT	1200 kg (Z16)
	800 kg (Z20)
CYCLE NUMBER	200 cycles/day
PROTECTION DEGREE	IP44
ABSORBED POWER	330 W
THRUST FORCE	1400 N (Z16)
	1120 N (Z20)
MAX. LINEAR SPEED	9,5 m/min (Z16)
	12,0 m/min (Z20)
OPERATING TEMPERATURE	-20° +70° C
LUBRICANT QUANTITY	1,25 Lt
LUBRICANT TYPE	AprimOil SPIRAX
HEIGHT OF PINION FROM GROUND	70 mm
WEIGHT OPERATOR	13 Kg

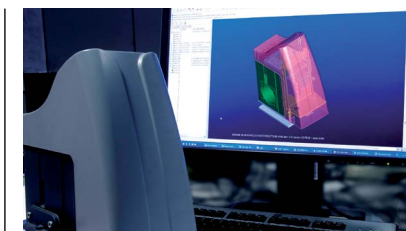



Anti-crushing device with wet mechanical clutch.

Emergency release lever with customised key for gate release and an effective anti-intrusion protection.

Wet gear motor with self-locking reduction unit for lockless application.

Maximum reliability thanks to steel gears and permanent system lubrication.

It can be secured to the ground both via a fixed and a tilting support.

The latter allows operation even when the guide is not on a perfectly level surface, thus preserving mechanical parts from operational stress.

SC230 electronic control unit on board of the operator. On AT80E model only.

IDEAL INSTALLATION - AT 80 WITHOUT CONTROL UNIT

ITEM NUMBER	DESCRIPTION	Q.ty	€
41120/021	AT80 Z16 Gear motor without control unit	1	542,50
41180/063	CZ - APRIMATIC 4 m galvanised steel rack with mounts (module 4)	1	75,93
41615/801	ES 433.92 MHz sliding gate Elettrosset	Item numbers included in the kit 1	442,63
	SC230 control unit with 433.92MHz built-in radio receiver	41626/001	
	433.92 MHz antenna kit	41929/003	
	ER12-24V Pair of photocells	41812/008	
	ET20N 230V flashing light	41840/006	
	Two TM4 433.92 MHz four-channel transmitters	41905/004	
	PC12E Wall-mounted key-operated switch	41830/007	
	Signal panel		

NOTE: Use of a safety edge is recommended; see section "Control units and Indicators".

IDEAL INSTALLATION - AT 80E WITH CONTROL UNIT

ITEM NUMBER	DESCRIPTION	Q.ty	€
41120/023	AT80E Z16 Gear motor with SC230 on-board control unit with built-in 433.92 MHz receiver	1	863,60
41180/063	CZ - APRIMATIC 4 m galvanised steel rack with mounts (module 4)	1	75,93
41700/801	EKK-24V Elettrokkit	Item numbers included in the kit 1	237,61
	433.92 MHz antenna kit	41929/003	
	ER12-24V Pair of photocells	41812/008	
	ET2N- 24V Led flashing light	41840/006	
	Two TM4 433.92 MHz four-channel transmitters	41905/004	
	PC12E Wall-mounted key-operated switch	41830/007	
	Signal panel		

NOTE: Use of a safety edge is recommended; see section "Control units and Indicators".

ITEM NUMBER	DESCRIPTION	€
41120/023	AT 80E YZ16 (rack required) Gear motor with on-board SC230 control unit with built-in radio, 16-teeth pinion and electromechanical limit stop	863,60
41120/021	AT 80 YZ16 (rack required) Gear motor preset for the integration of SC 230 control unit, 16-teeth pinion and electromechanical limit stop	542,50

NOTE: Each installation requires an IF 80 or IB 80 package.

ITEM NUMBER	ACCESSORIES	€
41120/051	IF80 - Fixed installation package	17,95
41120/052	IB80 - Tilting installation package	49,25
41120/050	PF80 - Foundation plate for masonry installation (package with 4 pieces)	each. 17,38
41180/063	CZ - APRIMATIC 4 m galvanised steel rack with mounts (module 4)	75,93
41127/101	Z20 - 20-teeth pinion	42,81

NOTE: For the available safety and signalling devices and for installation accessories, see section "Control units and indicators" in this catalogue (refer to the initial index).

NOTE: All prices are subject to variation.



ONDA 2000 / 2001

i215

Gear motor for sliding gates with wings from 1000 up to 2000kg.
Intensive use.

TECHNICAL DATA

MAIN POWER SUPPLY	230 V - 50 Hz
MAX. WING WEIGHT	2000 kg
CYCLE NUMBER	1000 cycles/day
PROTECTION DEGREE	IP44
ABSORBED POWER	700 W
THRUST FORCE	2570 N
MAX. LINEAR SPEED	9,5 m/min
OPERATING TEMPERATURE	-20° +70° C
LIMIT STOP	Electromechanical
PINION	Z16
LUBRICANT TYPE	AprimOil SPIRAX
WEIGHT OPERATOR	18KG





For residential use, up to 2,000 kg,
or condominium use up to 1,000 kg.

ONDA 2001 - with on-board SC 230 device
and electronic control unit.

Practical lever release with customised
key for emergency operations.

ONDA 2000 - with mechanical clutch
for anti-crushing safety without on-board
electronic control unit.

Worm screw gear motor
with permanent lubrication and anodised
aluminium body.

NOTE: Due to the high power of the motor, properly evaluate the system risk analysis.

IDEAL INSTALLATION - ONDA 2000 Z16 MOTOR WITH MECHANICAL CLUTCH

ITEM NUMBER	DESCRIPTION	Q.ty	€
41125/007	ONDA 2000 Z16 Motor with mechanical clutch	1	594,65
41180/063	CZ - Aprimatic 4m galvanised steel rack with mounts (module 4)	1	75,93
41615/801	ES 433.92 MHz sliding gate Elettroset	Item numbers included in the kit 1	442,63
	SC230 control unit	41626/001	
	433.92 MHz antenna kit	41929/003	
	ER12-24V Pair of photocells	41812/008	
	ET2N 24V led flashing light	41840/006	
	Two TM4 433.92 MHz four-channel transmitters	41905/004	
	PC12E Wall-mounted key-operated switch	41830/007	
	Signal panel		

NOTE: Use of a safety edge is recommended; see section "Control units and Indicators".

IDEAL INSTALLATION - ONDA 2001 E Z16 MOTOR WITH ELECTRONIC CLUTCH

ITEM NUMBER	DESCRIPTION	Q.ty	€
41125/005	ONDA 2001 E Z16 Motor with electronic clutch and on-board SC 230 control unit with built-in 433.92 MHz receiver	1	729,70
41180/063	CZ - Aprimatic 4m galvanised steel rack with mounts (module 4)	1	75,93
41700/801	EKK-24V Elettrokit	Item numbers included in the kit 1	237,61
	433.92 MHz antenna kit	41929/003	
	ER12-24V Pair of photocells	41840/006	
	ET2N- 24V Led flashing light	41840/006	
	Two TM4 433.92 MHz four-channel transmitters	41905/004	
	PC12E Wall-mounted key-operated switch	41830/007	
	Signal panel		

NOTE: Use of a safety edge is recommended; see section "Control units and Indicators".

ITEM NUMBER	DESCRIPTION	€
41125/007	ONDA 2000 Z16 (rack required) Gear motor with mechanical clutch and 16-teeth pinion, preset for the integration of the control unit	each. 594,65
41125/005	ONDA 2001 E Z16 (rack required) Gear motor with on-board SC 230 control unit with built-in 433.92 MHz receiver, electronic clutch and 16-teeth pinion	729,70

ITEM NUMBER	OPTIONAL ACCESSORIES	€
41125/050	PF2000 - Foundation plate	each. 22,01
41180/063	CZ - Aprimatic 4m galvanised steel rack with mounts (module 4)	75,93

NOTE: For the available safety and signalling devices and for installation accessories, see section "Control units and indicators" in this catalogue (refer to the initial index).

NOTE: All prices are subject to variation.



AT 86 T / AT 88 T

i216

Automation for
industrial sliding gates.
Intensive use.



AT 88T MOTOR

TECHNICAL DATA	AT 86T	AT 88T
MAIN POWER SUPPLY	Three-phase 230/400 V - 50/60 Hz	Three-phase 230/400 V - 50/60 Hz
MAX. GATE WEIGHT	2000 kg	4000 kg
PROTECTION DEGREE	IP44	IP44
MOTOR POWER	1 kW	0,96 kW
MAX ABSORBED CURRENT	1,07 A (a 400 V)	2,6 A (a 400 V)
NO. OF MOTOR/PINION REVS g/1'	1400/36	1400/33
DRIVE SPEED m/1'	9	9
PINION MODULE	4 mm	4 mm
OPERATING TEMPERATURE	-15° +60° C	-15° +60° C
LUBRICANT BRAND	API DT SINT 320	API DT SINT 320
WEIGHT OPERATOR	35 Kg	50 Kg



These motors are designed to drive very heavy sliding gates. Intended for an intensive use, they guarantee a high degree of reliability

Adjustable dry clutch between the motor and gear unit, for the preservation of mechanical parts in case of obstacles to the movement of the gate.

Toothed pinion suitable for 4 mm rack module. Rack available in 1 m items with adjustment slots and spacers for gate installation. Bidirectional lever mechanical limit stop.

The electromechanical unit consists of a ventilated three-phase motor, coupled to a steel worm screw gear unit and a bronze gear.

Emergency manual operation thanks to a device for trip disengaging mounted on the gear unit, easily operable by rotating the lever.

The gear motor is encased in a stainless steel protective box with ABS inspection door that can be opened with a key.

IDEAL INSTALLATION - AT 86T

ITEM NUMBER	DESCRIPTION	Q.ty	€
41134/002	AT 86T Three-phase gear motor	1	2019,32
41615/008	A888 control unit	1	521,96
41923/009	RRSE - Unico 433.92 MHz Memory System receiver	1	88,67
41929/001	ANT 433 433.92 MHz Antenna	1	19,12
41811/001	ER2N Pair of photocells	1	95,62
41841/001	ET22 230V flashing light	1	62,59
41905/004	TM4 - 433.92 MHz four-channel transmitter	N	each. 38,41
41180/063	CZ - Aprimatic 4m galvanised steel rack with mounts (module 4)	1	75,93
41830/007	PC12E Wall-mounted key-operated switch	1	27,81

NOTE: The same items can be used when installing an AT 88T gear motor.

NOTE: Use of a safety edge is recommended; see section "Control units and Indicators".

N: Based on specific installation requirements

ITEM NUMBER	DESCRIPTION	€
41134/002	AT 86T - Three-phase gear motor (with foundation plate)	2019,32
41124/001	AT 88T - Three-phase gear motor (with foundation plate)	2179,29

ITEM NUMBER	ACCESSORIES	€
41615/008	A888 Electronic control unit in sealed APRIMATIC container (IP55) with 4 operating modes: automatic, semi-automatic, dead-man operation, suitable for a three-phase (230/380 V - 50 Hz) or single-phase (740W) operator with max. power 740W	521,96
41180/063	CZ - Aprimatic 4m galvanised steel rack with mounts (module 4)	75,93
41850/002	CF1M - Straight safety edge 1.5 m	68,39
41850/003	CF2M - Straight safety edge 2 m	75,33
41850/004	CF3M - Straight safety edge 3 m	85,68

NOTE: The use of a safety edge is recommended.

NOTE: For the available safety and signalling devices and for installation accessories, see section "Control units and indicators" in this catalogue (refer to the initial index).

NOTE: All prices are subject to variation.



AT 90 T / AT 92 T

i217

Automation for
industrial sliding gates.
Intensive use.



AT 90T MOTOR

TECHNICAL DATA	AT 90T	AT 92T
MAIN POWER SUPPLY	Three-phase 230/400 V - 50/60 Hz	Three-phase 230/400 V - 50/60 Hz
MAX. GATE WEIGHT	8000 Kg	12000 Kg
PROTECTION DEGREE	IP44	IP44
MOTOR POWER	1,5 kW	3 kW
MAX. ABSORBED CURRENT	3,5 A (a 400 V)	6,8 A (a 400 V)
NO. OF MOTOR/PINION REVS G/1'	1400/23	1400/20
DRIVE SPEED M/1'	8	9
PINION MODULE	5 mm	8 mm
OPERATING TEMPERATURE	-15° +60° C	-15° +70° C
LUBRICANT	DTSINT 320	TIVELA OIL SC320
WEIGHT OPERATOR	70 Kg	200 Kg



These motors are designed to drive very heavy sliding gates. Intended for an intensive use, they guarantee a high degree of reliability

Adjustable dry clutch between the motor and gear unit, for the preservation of mechanical parts in case of obstacles to the movement of the gate.

Toothed pinion suitable for 5 mm rack module (Mod. AT 90T) and 8 mm (Mod. AT 92T). Rack available in 1 m items with adjustment slots and spacers for gate installation.

Bidirectional lever mechanical limit stop.

The electromechanical unit consists of a ventilated three-phase motor, coupled to a steel worm screw gear unit and a bronze gear.

Emergency manual operation thanks to a device for trip disengaging mounted on the gear unit, easily activated by rotating the lever (for Mod. AT 90T).

The gear motor is encased in a stainless steel protective box with stainless steel inspection door that can be opened with a key.

IDEAL INSTALLATION - AT 90T

ITEM NUMBER	DESCRIPTION	Q.ty	€
41134/001	AT 90T Three-phase gear motor	1	5436,07
41637/001	8382L three-phase control unit without receiver	1	751,15
41923/009	RRSE - Unico Memory System 433.92 MHz receiver	1	88,67
41929/001	ANT433 433.92 MHz antenna	1	19,12
41811/001	ER2N Pair of photocells	1	95,62
41841/001	ET22 230V flashing light	1	62,59
41905/004	TM4 - 433.92 MHz four-channel transmitter	N	each. 38,41
41180/061	CZ Module 5 steel rack (1M)	N (order N metres based on gate length)	each. 124,64

NOTE: The same items can be used when installing an AT 92T gear motor, swapping the rack with module 8.

NOTE: Use of a safety edge is recommended; see section "Control units and Indicators".

N: Based on specific installation requirements

ITEM NUMBER	DESCRIPTION	€
41134/001	AT 90T - Three-phase gear motor (with foundation plate)	5436,07
41134/003	AT 92T - Three-phase gear motor (with template and foundation plate)	7878,02
41637/001	8382L three-phase unit (without receiver)	751,15

ITEM NUMBER	ACCESSORIES	€
41180/061	CZ - Rack rail in galvanised steel, module 5 (1 m with joints) - for AT 90T	124,64
41180/062	CZ - Rack rail in galvanised steel, module 8 (1 m with screws) - for AT 92T	237,63
41850/002	CF1M - Straight safety edge 1.5 m	68,39
41850/003	CF2M - Straight safety edge 2 m	75,33
41850/004	CF3M - Straight safety edge 3 m	85,68

NOTE: The use of a safety edge is recommended.

NOTE: For the available safety and signalling devices and for installation accessories, see section "Control units and indicators" in this catalogue (refer to the initial index).

NOTE: All prices are subject to variation.



04.

UP-AND-OVER, SECTIONAL, FOLDING DOORS

ALZO
AT 50
MATIC-BOX 800
MATIC-BOX 1200

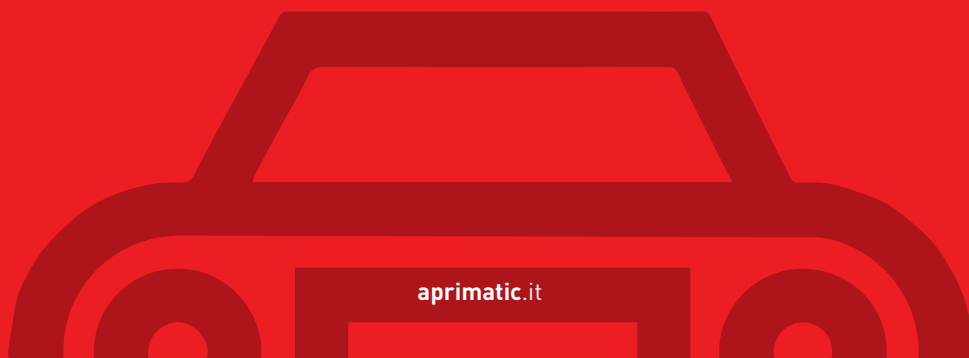





UP-AND-OVER / SECTIONAL DOORS

TYPES

UP-AND-OVER DOOR WITH COUNTERWEIGHTS OR SPRINGS (with door automation)

Door equipped with balancing system with counterweights or springs. On opening and closing, the door may wholly fall within or partly protrude. Application with single or double motor for heavy doors or up-and-over doors with built-in pedestrian door.



Electromechanical
ALZO
TWIN ALZO

Hydraulic
AT 50
TWIN AT50

COUNTERWEIGHT-BALANCED UP-AND-OVER DOOR (with drive or spring operator)

Door equipped with balancing system with counterweights or springs. On opening and closing, the door may wholly fall within or partly protrude.



Electromechanical
MATIC-BOX 800
MATIC-BOX 1200

SECTIONAL DOOR

Door equipped with spring balancing system. Consisting of many horizontal panels hinged together. When opening, the door falls entirely within the garage.



Electromechanical
MATIC-BOX 800
MATIC-BOX 1200



TYPICAL SYSTEM COMPOSITION

1) Operator: device allowing, with an external power supply, to move a door.
 2) Control unit: electronic unit for handling the operator movement.
 3) Transmitter: wireless equipment that transmits information to the control unit.
 4) Antenna: device that increases the reception of the signals sent by the transmitter.

5) Flashing light: light signalling that the gate is moving.
 6) Pair of photocells: safety devices stopping the gate movement in the presence of obstacles.
 7) Control unit: allows activation of gate movement through a mechanical or electronic key.

8) Safety edge: Sensitive edge used to prevent the risk of crushing due to electric door movement. In case of contact, the automation system inverts motion and prevents damage to people and property.

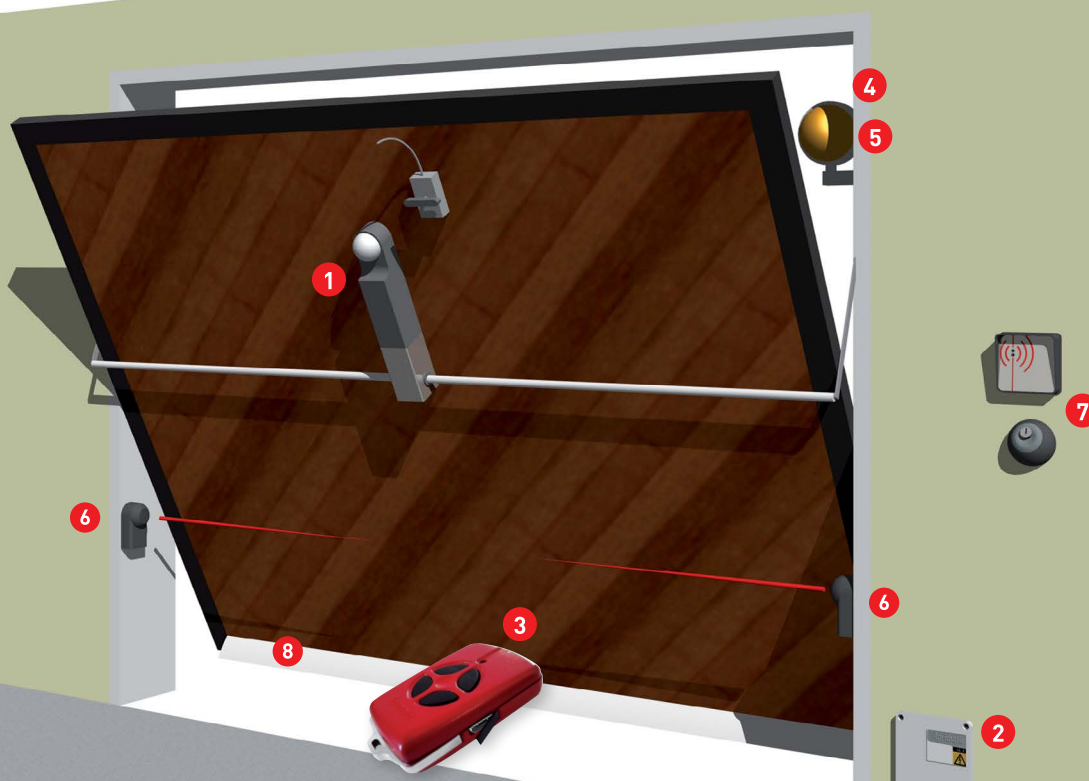



REFERENCE LAYOUT FOR UP-AND-OVER DOOR SYSTEM

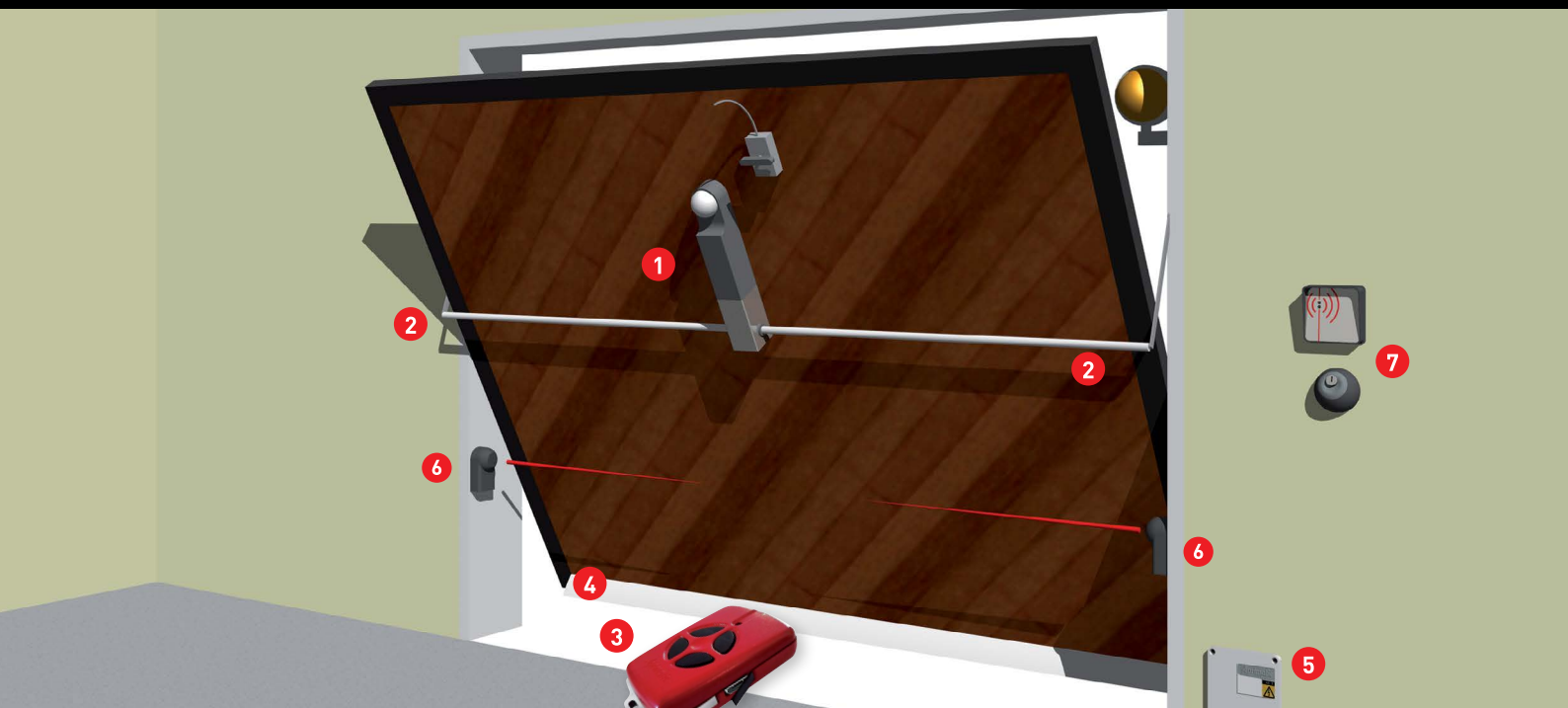

KEY

1 Operator

2 Pair of curved arms / curved arm

3 Transmitter

4 Safety edge





5 Electronic control unit

6 Pair of photocells

7 Control device

CHOOSING THE RIGHT PRODUCT

AUTOMATION SYSTEMS FOR COUNTERWEIGHT-BALANCED UP-AND-OVER DOORS

	MODEL	USE	CYCLES PER DAY	DOOR DIMENSION	SAFETY	TECHNOLOGY	PAGE
	ALZO	(R)	50	3,5 x 3,0 m	A*	Electromechanical	84
	TWIN ALZO	(R)	50	5,0 x 3,0 m	A*	Electromechanical	84
	AT 50	(R) (C)	150	3,5 x 3,0 m	Bypass valves	Hydraulic	86
	TWIN AT 50	(R) (C)	150	5,0 x 3,0 m	Bypass valves	Hydraulic	86



REFERENCE LAYOUT FOR SECTIONAL DOORS / COUNTERWEIGHT-BALANCED UP-AND-OVER DOORS

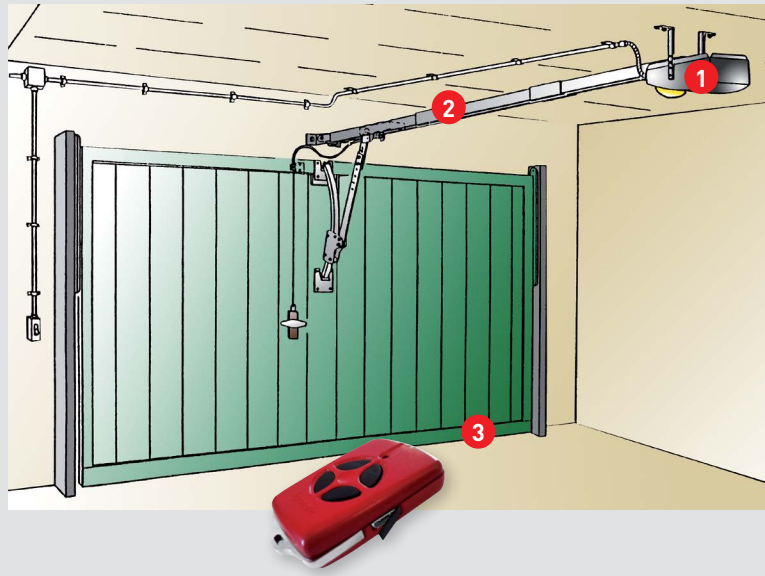
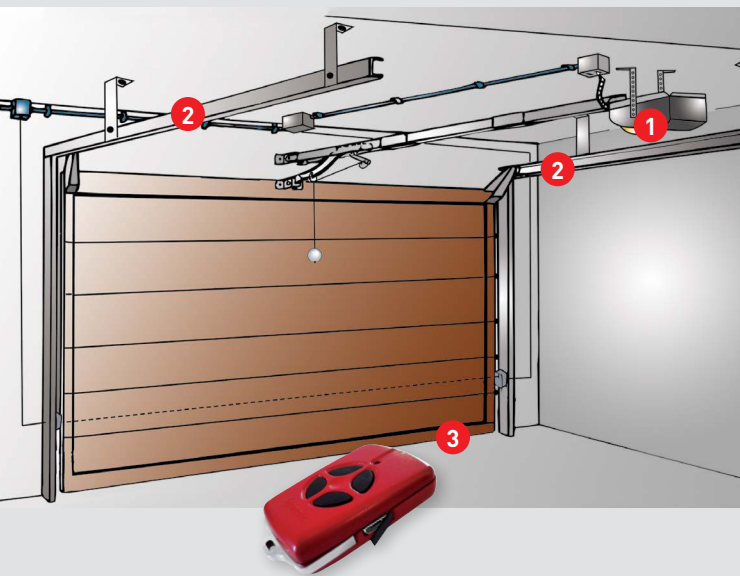

NOTE: For equipment and control, safety and warning devices, see the optional accessories indicated for the specific operator.



NOTE: For more devices, see the section "Control units and Indicators" in this catalogue (refer to the initial index).

06. Control devices and indicators
05. Traffic barriers
04. Up-and-Over, Sectional, Folding Doors

03. Sliding gates
02. Swing gates

01. Automation kits

DRIVEN AUTOMATION SYSTEMS FOR SECTIONAL AND UP-AND-OVER DOORS

	MODEL	USE	CYCLES PER DAY	DOOR DIMENSION	SAFETY	TECHNOLOGY	PAGE
	MATIC-BOX 800**	(R)	30	10/12 mq	A*	Electromechanical	88
	MATIC-BOX 1200**	(R)	30	14-18mq	A*	Electromechanical	88

KEY

(R) RESIDENTIAL

(C) CONDOMINIUM

(I) INDUSTRIAL

*A - Anti-crushing

**Suitable for counterweight-balanced up-and-over doors if equipped with curved arm.

NOTE: The data provided refer to correctly installed products undergoing regular maintenance.

NOTE: The choice depends on the force required to move the frame and not on its size.



ALZO



Electromechanical operator
for up-and-over doors
Residential use.

TECHNICAL DATA

MAIN POWER SUPPLY	230 V - 50 Hz
NOMINAL TORQUE	450 Nm
INTERMITTENT USE	50%
SHEET DIMENSION	3,5 x 3 m single motor 5 x 3 m double motor
PROTECTION DEGREE	IP44
ABSORBED POWER	250 W
ABSORBED CURRENT	1,6 A
OPERATING TEMPERATURE	-20° +60° C
OPENING TIME	17 s
OVERLOAD INTERVENTION	150° C
WEIGHT OPERATOR	9 Kg





Self-locking gear motor, keeping the up-and-over door closed even in the absence of an electric lock.

External emergency release (optional) for accessing the garage in case of power supply failure.

High-quality materials:
steel transmission parts die-cast aluminium gear motor body and ABS protection hood with IP44 protection degree.

Maximum anti-crushing safety for the lower edge of the door, thanks to the on-board electronic control unit equipped with electronic torque adjustment and anti-crushing system (which can be disabled) with sensitive edges.

Timed courtesy light built into the operator to light up the garage during opening and closing.

Slowdown system for a soft approach of the door during opening and closing, thus avoiding noise and mechanical stress to the structure.

One of the best operators in the market.
Developing a 450 Nm torque, it allows the automation of counterweight-balanced up-and-over doors with size:
- 3.5 x 3 m using only one motor;
- 5 x 3 m, or up-and-over with built-in pedestrian door using two motors.

IDEAL INSTALLATION FOR SINGLE MOTOR (max. sheet dim. 3.5x3 m)

ITEM NUMBER	DESCRIPTION	Q.ty	€
41210/002	EM51 OPERATOR with T3EC on-board control device (without receiver)	1	498,44
41923/009	RRSE - Unico 433.92 MHz receiver	1	88,67
41905/004	TM4 - 433.92 MHz four-channel transmitter	N	38,41
41210/058	Pair of plasma-cut curved arms	1	79,76
41210/062	HARDWARE KIT	1	126,05
	Two TZ - Ø25mmx3 galvanised pipes with 1.8 m pre-welded bushes	41210/068	
	ST180 - 180 cm sheet fixing bracket	41210/061	

NOTE: The installation can be completed by adding a flashing light

N: Based on specific installation requirements

IDEAL INSTALLATION FOR DOUBLE MOTOR (max. sheet dim. 5x3 m)

ITEM NUMBER	DESCRIPTION	Q.ty	€
41210/002	EM51 OPERATOR with T3EC on-board control device (without receiver)	1	498,44
41210/001	EM51 SLAVE OPERATOR Including a pair of 20 cm pipes with splined bush	1	396,43
41210/069	Pair of straight arms, with quick coupling (required for double motor installation)	1	64,91
41210/061	ST180 - Sheet fixing bracket L= 180 cm	2	32,45
41923/009	RR SE - Unico 433.92 MHz receiver	1	88,67
41905/004	TM4 - 433.92 MHz four-channel transmitter	N	38,41

NOTE: The installation can be completed by adding a flashing light

N: Based on specific installation requirements.

ITEM NUMBER	DESCRIPTION	€
41210/002	EM51 T3EC OPERATOR - T3EC on-board electronic control unit (without receiver) Aprimatic signal panel	498,44
41210/001	EM51 SLAVE OPERATOR - Including a pair of 20 cm pipes with splined bush	396,43

ITEM NUMBER	OPTIONAL ACCESSORIES	€
41840/006	ET2N - 24V led flashing light	42,30
41812/008	ER12-24V Pair of photocells	71,16
41210/054	SS EM 51 - Single external emergency release	22,01
41210/055	SD EM 51 - Double external emergency release	44,61
41201/052	Pair of straight telescopic arms	44,79
41201/051	Pair of curved telescopic arms	89,52
41210/068	TZ - 1.8 m Ø 25 mm x 3 galvanised pipe with pre-welded bushes	49,42
41210/061	ST180 - 180 cm sheet fixing bracket	32,45
41210/067	PST - Sheet fixing bracket extension	17,95
41850/001	CF3MS - 3.0 m straight safety edge (thin and specific for garage doors)	79,19

NOTE: Also application requires a rebalancing of the door (see instructions).

NOTE: For the available safety and signalling devices and for installation accessories, see section "Control units and indicators" in this catalogue (refer to the initial index).

NOTE: All prices are subject to variation.



AT 50



Hydraulic operator
for up-and-over doors.
Residential, condominium
and intensive use.

TECHNICAL DATA

AT50B7

MAIN POWER SUPPLY	230 V - 50 Hz
NOMINAL TORQUE AT 40 BAR	320Nm
SHEET DIMENSION	3,5 x 3 m single motor 5 x 3 m double motor
PROTECTION DEGREE	IP53
ABSORBED POWER	250 W
NOMINAL TORQUE AT 40 BAR	320 Nm
OPERATING TEMPERATURE	-20°+60° C
OPENING TIME	13 s approx..
MAX. OPERATING PRESSURE	40 bar
PUMP CAPACITY	1 Lt/min
OIL QUANTITY	1,3 Lt
WEIGHT WITH OIL	13 kg
OIL TYPE	AprimOil
SLOWDOWN	With T3E unit
WEIGHT OPERATOR	10 Kg





Maximum anti-crushing safety thanks to the sensitive edges (optional) combined with maximum pressure relief valves that limit the maximum value of the hydraulic pressure in the presence of obstacles (adjustable during installation).

Ideal for heavy workloads in the presence of large-sized up-and-over doors.

Locks on opening and closing (double lock): the door remains shut without installing further locks.

AT 50 can be easily installed without modifying the up-and-over doors.

Very high resistance to shocks and stress during operation thanks to the ductile cast iron body.

Great hydraulic sealing thanks to internal scrapers.

Silent and regular performance guaranteed by polyurethane seals and P.T.E. guide rings.

IDEAL INSTALLATION FOR SINGLE MOTOR (max. sheet dim. 3.5x3 m)

ITEM NUMBER	DESCRIPTION	PCS	€
41200/005	AT50B7 Operator	1	627,12
41625/003	T3E - Electronic control unit	1	277,38
41923/009	RR SE - Unico 433.92 MHz superheterodyne receiver	1	88,67
41905/004	TM4 - 433.92 MHz four-channel transmitter	N	38,41
41210/069	Pair of quick-fit straight arms	1	64,91
41210/068	TZ - 1.8 m Ø 25 mm x 3 galvanised pipe with pre-welded bushes	2	49,42
41201/056	Pair of 30x15x1.5 mm tubular upright supports - 2.5 m bars	1	31,29

NOTE: The installation can be completed by adding a flashing light

N: Based on specific installation requirements

IDEAL INSTALLATION FOR DOUBLE MOTOR (max. sheet dim. 5x3 m)

ITEM NUMBER	DESCRIPTION	PCS	€
41200/005	AT50B7 Operators	2	627,12
41625/003	T3E - Electronic control unit	1	277,38
41923/009	RR SE - Unico 433.92 MHz superheterodyne receiver	1	88,67
41905/004	TM4 - 433.92 MHz four-channel transmitter	N	38,41
41210/069	Pair of quick-fit straight arms	1	64,91
41201/055	Pair of 20 cm pipes with pre-welded splined bushes	1	34,35
41201/056	Pairs of tubular upright supports 30x15x1.5 mm - 2.5 m bars	2	31,29

NOTE: The installation can be completed by adding a flashing light

N: Based on specific installation requirements

ITEM NUMBER	DESCRIPTION	€
41200/005	AT 50B7 Operator	627,12
41625/003	T3E - Electronic control unit	277,38

ITEM NUMBER	OPTIONAL ACCESSORIES	€
41840/006	ET2N -24V led flashing light	42,30
41812/008	ER12-24V Pair of photocells	71,16
41201/050	ALZO/AT 50 slowdown limit stop unit	29,42
41200/050	SS AT 50 - AT 50 Single external emergency release	26,65
41200/051	SD AT 50 - AT 50 Double external emergency release	55,51
41201/051	Pair of curved telescopic arms	89,52
41201/052	Pair of straight telescopic arms	44,79
41201/055	Pair of 20 cm pipes with pre-welded splined bushes	34,35
41850/001	CF3MS - 3.0 m straight safety edge (thin and specific for garage doors)	79,19

NOTE: AT 50 application requires a rebalancing of the door (see instructions).

NOTE: For the available safety and signalling devices and for installation accessories, see section "Control units and indicators" in this catalogue (refer to the initial index).

NOTE: All prices are subject to variation.



MATIC-BOX 800 / 1200

24
Vdc



800
N

1200
N

i218

Low-voltage
electromechanical
operator for sectional and
counterweight-balanced
up-and-over doors.
Residential use.

TECHNICAL DATA

	800	1200
MAIN POWER SUPPLY	220-240V AC 50/60Hz	220-240V AC 50/60Hz
MOTOR POWER SUPPLY	24DC	24DC
OUTPUT VOLTAGE	80W	120W
TRACTION FORCE	800N	1200N
OPENING/CLOSING SPEED	0.15 m/s	0.15 m/s
LAMP	LED	LED
LIGHTING TIME	3 minutes	3 minutes
DECODING	Rolling code	Rolling code
BATTERY	Optional	Optional
RADIO FREQUENCY	433.92MHz	433.92MHz
OPERATING TEMP.	-20°C / +50°C	-20°C / +50°C
RELATIVE HUMIDITY	<90%	<90%
MAXIMUM DOOR SIZE	10/12 m ²	14/18 m ²
DIMENSIONS (mm)	400x250x150	400x250x150
WEIGHT OPERATOR	5 Kg	5 Kg





Maximum anti-crushing safety thanks to the on-board electronic control unit equipped with auto reverse safety system when an obstacle is detected while closing the gate and to the use of sensitive edges.

The kit **MATIC-BOX** can be used for sectional doors and when installed with the accessory adapter arm, even to automate up-and-over doors.

Slowdown system for a soft approach of the door during opening and closing, thus avoiding noise and mechanical stress to the structure.

Timed courtesy light built into the operator to light up the garage during opening and closing.

The **pre-assembled guides** optimise installation time, while the encoder-controlled stroke simplifies the configuration phase.

Silent and resistant thanks to the belt drive.

Continuity of operation guaranteed, in the event of power supply failure, by a set of optional batteries which may be fitted inside the operator casing. Possibility of manual operation via the release system (optional).

IDEAL INSTALLATION - MATIC-BOX 800

ITEM NUMBER	DESCRIPTION	Q.ty	€
41243/800	MATIC-BOX 800 Operator with on-board unit and 433.92 MHz radio receiver, nr.2 TM4 four channel transmitter (guide NOT included -see "Guides and accessories)	1	279,00
41905/004	TM4 - 433.92 MHz four-channel transmitter	N	38,41

N: Based on specific installation requirements

IDEAL INSTALLATION OF COUNTERWEIGHT-BALANCED UP-AND-OVER DOORS - MATIC-BOX 1200

ITEM NUMBER	DESCRIPTION	Q.ty	€
41243/810	MATIC-BOX 1200 Operator with on-board unit and 433.92 MHz radio receiver, nr.2 TM4 four channel transmitter (guide NOT included -see "Guides and accessories)	1	353,00
41241/056	Adapter arm for counterweight-balanced up-and-over doors	1	185,46
41905/004	TM4 - 433.92 MHz four-channel transmitter	N	38,41

N: Based on specific installation requirements

ITEM NUMBER	DESCRIPTION	Max. sheet dimension	€
41243/800	MATIC-BOX 800	10/12 m ²	279,00
41243/810	MATIC-BOX 1200	14/18 m ²	353,00

The two packages include:

The MATIC-BOX MATIC-BOX Operator with on-board unit and 433.92 MHz radio receiver, nr.2 TM4 four channel transmitter

ITEM NUMBER	MATIC-BOX GUIDES AND ACCESSORIES	€
41241/056	Adapter arm for counterweight-balanced up-and-over doors	185,46
41243/058	3,30m Belt drive rail 2part (2 pcsx1,65m)	78,00
41243/059	3,90m Belt drive rail 3 part (3 pcs x 1,30m)	88,00
41840/006	ET2N -24V led flashing light	42,30
41812/008	ER12-24V Pair of photocells	71,16

NOTE: For the available safety and signalling devices and for installation accessories, see section "Control units and indicators" in this catalogue (refer to the initial index).

NOTE: All prices are subject to variation.



05.

TRAFFIC BARRIERS

HARRIER 4000R
HARRIER 4000I
HARRIER 6000I
HARRIER 8000I







TRAFFIC BARRIERS

TYPES

SINGLE OR DOUBLE BARRIERS FOR RESIDENTIAL USE

230V barriers employed in the management of small private or condominium car parks, with limited vehicle traffic.



Electromechanical
Harrier 4000R

SINGLE OR DOUBLE BARRIERS FOR CONDOMINIUM AND INTENSIVE USE

24V barriers used for the management of continuous use car parks in large apartment buildings, companies, or even private car parks with frequent passage of vehicles during the day.



Electromechanical
Harrier 4000I
Harrier 6000I

BARRIERS FOR INTENSIVE USE OR FOR LARGE-SIZED ENTRANCES

These barriers are also used for accesses used by special or large-sized vehicles.



Electromechanical
Harrier 8000I



TYPICAL SYSTEM COMPOSITION

- 1) Operator: device with an external power supply designed for access control.
- 2) Control unit: electronic unit for handling the operator movement.
- 3) Transmitter: wireless equipment that transmits information to the control unit.
- 4) Flashing light: light signalling that the gate is moving.
- 5) Pair of photocells: safety devices stopping the gate movement in the presence of obstacles.
- 6) Control unit: allows activation of gate movement through a mechanical or electronic key.

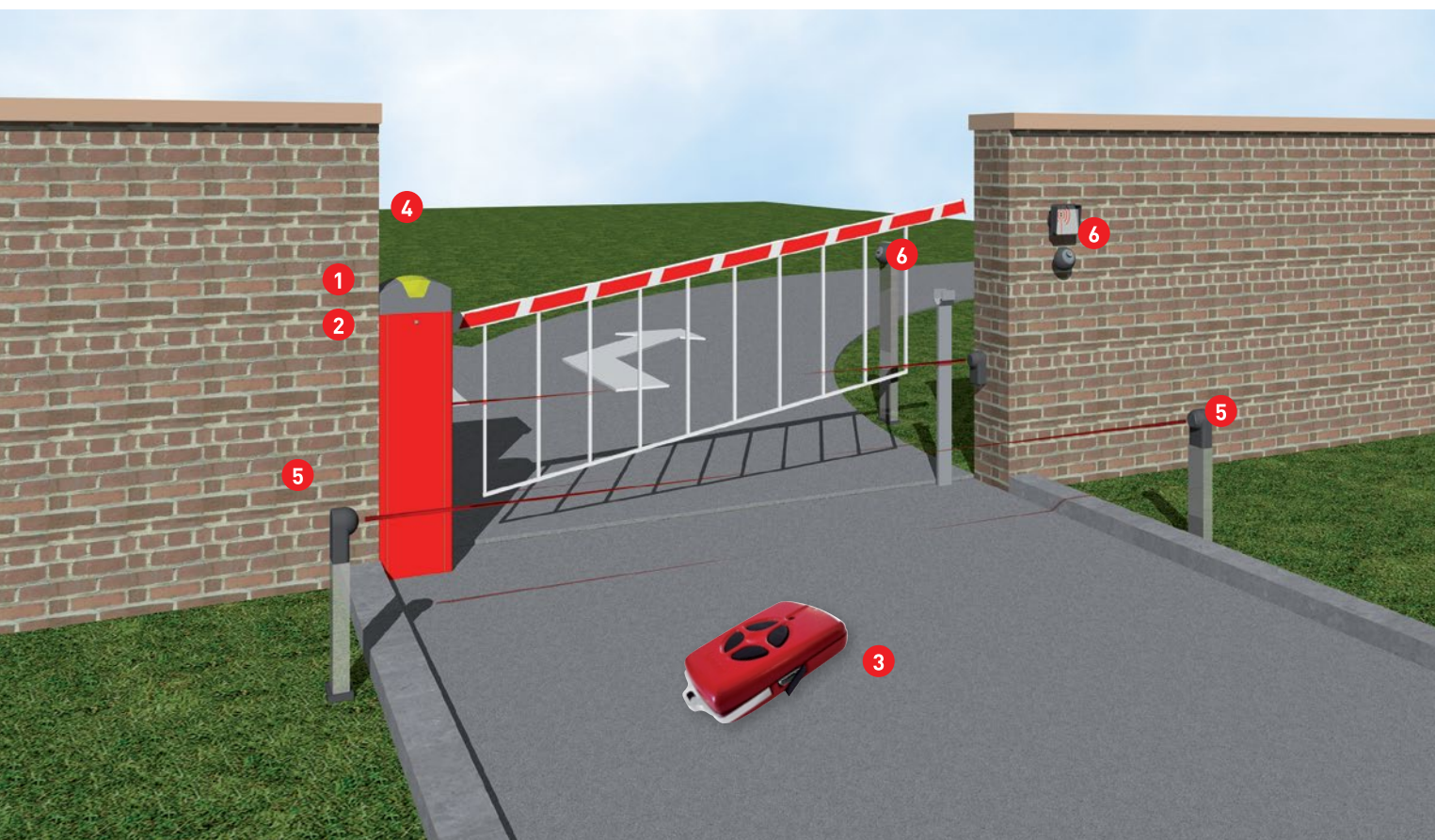



AUTOMATION SYSTEMS FOR TRAFFIC BARRIERS

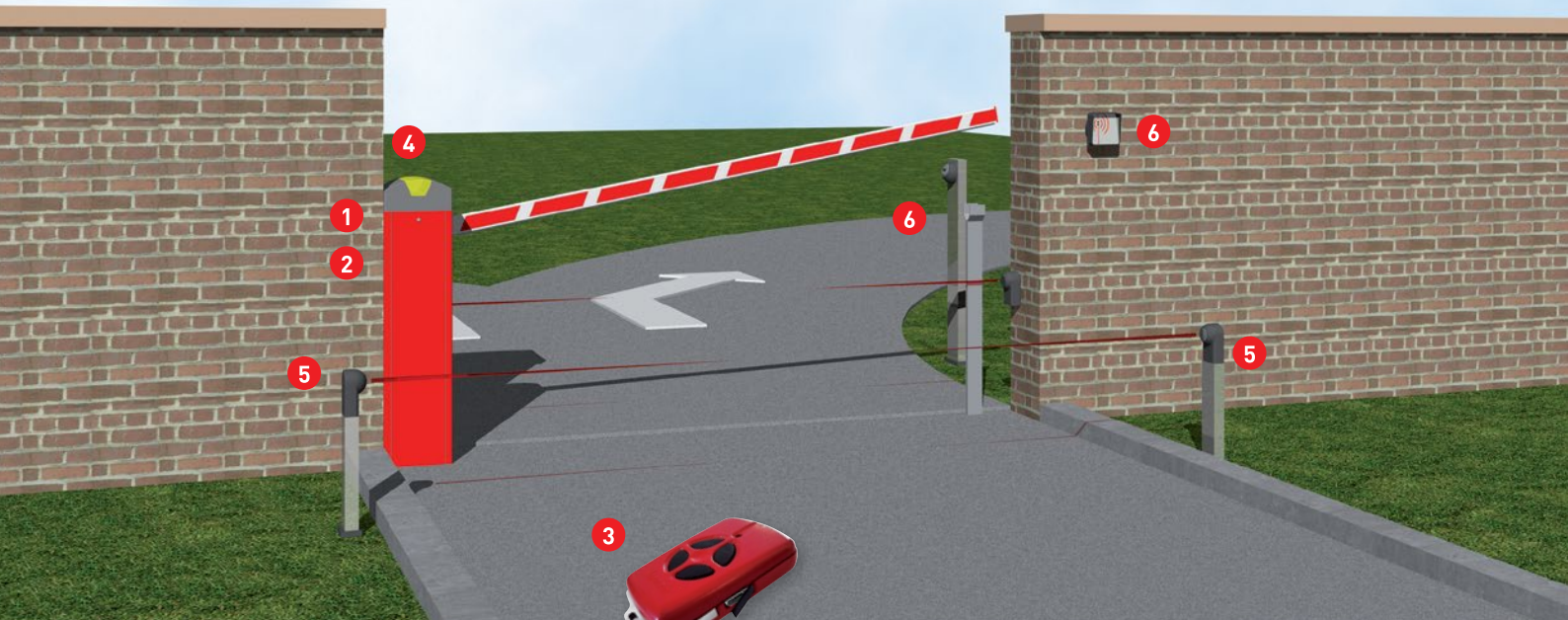





KEY

- 1 Automation for bars
- 2 Electronic control unit
- 3 Transmitter
- 4 Flashing light
- 5 Pair of photocells
- 6 Control device: key-operated switch / presence reader / keyboard combination lock / card reader / magnetic keys

CHOOSING THE RIGHT PRODUCT

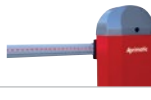
AUTOMATION SYSTEMS FOR TRAFFIC BARRIERS

	MODEL	USE	MOTOR POWER SUPPLY	FREQUENCY OF USE	BEAM MAX. LENGTH (M)	TECNOLOGY	PAGE
	HARRIER 4000R	Ⓡ	230V	40%	4m	Electromechanical	96
	HARRIER 4000I	Ⓢ Ⓡ	24V	85%	5m	Electromechanical	98
	HARRIER 6000I	Ⓢ Ⓡ Ⓡ	24V	85%	6m	Electromechanical	100
	HARRIER 8000I	Ⓢ Ⓡ Ⓡ Ⓡ	24V	85%	8m	Electromechanical	100



REFERENCE LAYOUT FOR BARRIER SYSTEM (BARRIER WITH SKIRT)

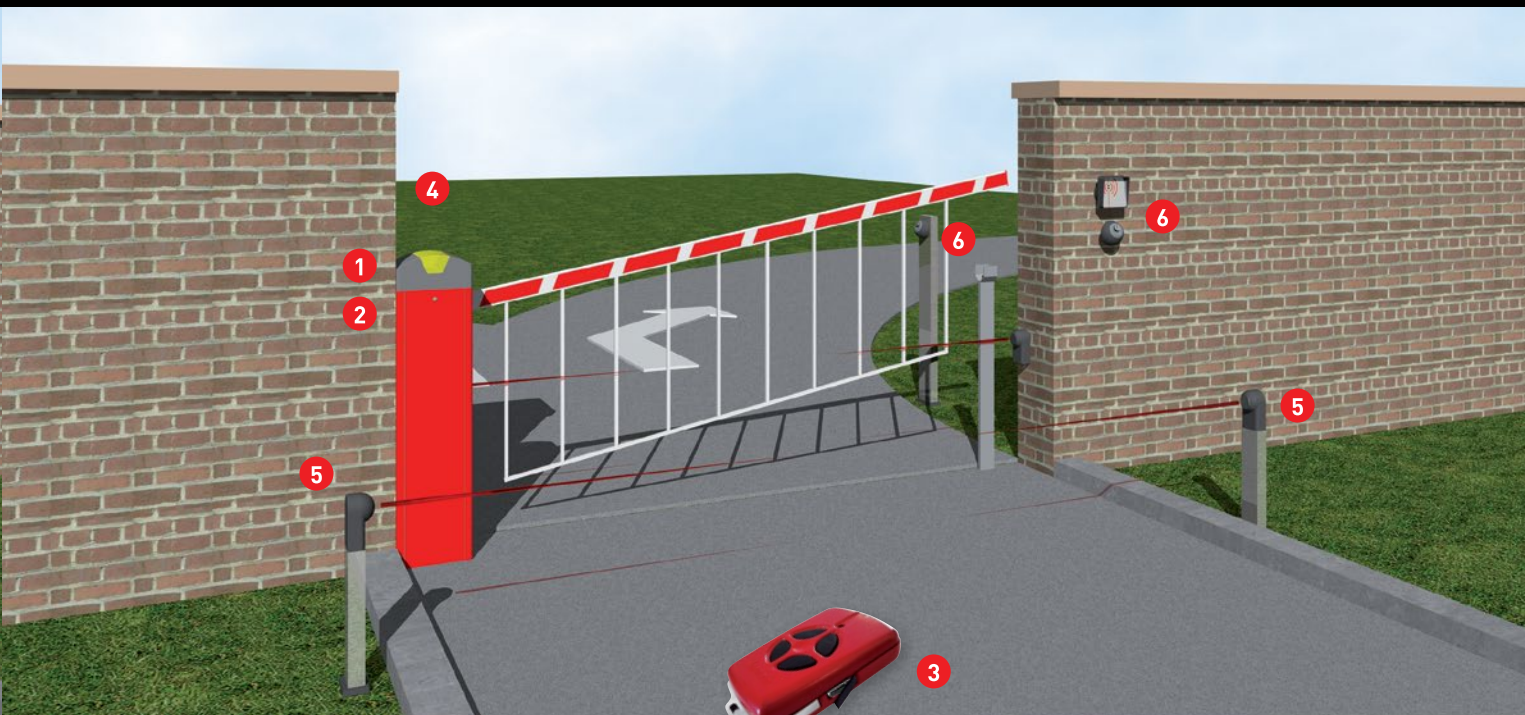

NOTE: For equipment and control, safety and warning devices, see the optional accessories indicated for the specific operator.

NOTE: For more devices, see the section "Control units and Indicators" in this catalogue (refer to the initial index).

TRAFFIC BARRIERS - BEAMS



Beam profile*
H65 (AAP)



Beam profile*
H100 (AAG)



Ø 80
Max length 6 m



Telescopic
4,5-6 m

ELECTROMECHANICAL BARRIERS

Harrier 4000R	●		●	
Harrier 4000I	●		●	●
Harrier 6000I		●	●	●
Harrier 8000I		●		

KEY

(R) RESIDENTIAL

(C) CONDOMINIUM

(I) INDUSTRIAL

* Beams with predisposition of accessories installation like shockproof rubber edge, Led lights strip kit, basculant pin. Accessories to be ordered for separate.

NOTE: The data provided refer to correctly installed products undergoing regular maintenance.



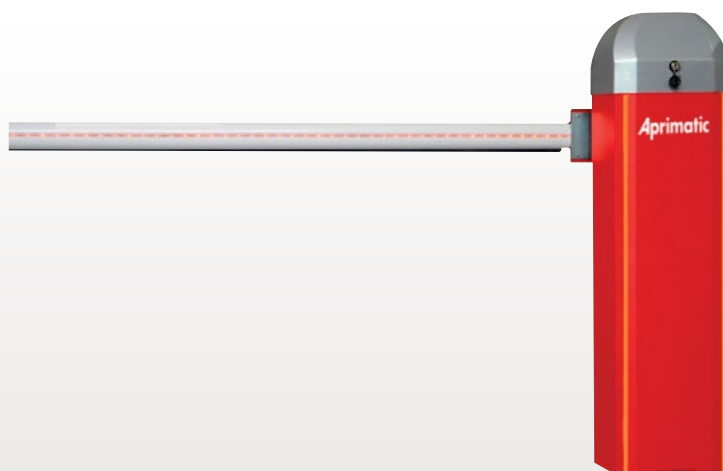

HARRIER 4000R

NEW

230 V

i219

Electromechanical traffic barriers 230V, for vehicle passage from 3 to 4 m.
Residential use.

TECHNICAL DATA

MAIN POWER SUPPLY	230 V - 50 Hz
OPENING TIME	7 s max.
BEAM LENGTH	from 3 to max. 4 m.
PROTECTION DEGREE	IP54
MAX. ABSORBED POWER.	180 W
ACCESSORY MAX. ABSORBED CURRENT	1,3 A
OPERATING TEMPERATURE	-25°+70° C
NOMINAL TORQUE	400 Nm
ANTI-CRUSHING	YES
WEIGHT BARRIER	40 Kg



Easy access for wiring and configuration in the upper part of the barrier.



User-friendly electronics: no configuration is required for basic use. Parameters are easy to check and set.

Easy to install: simple installation and configuration. IT is only necessary to balance the spring.

Reduced dimensions and next-generation design: long and narrow shape.

High intensity of use: suitable for the control of vehicular access for small/medium car parks for private use.

Main technical solutions adopted:

1. Super smooth action thanks to the spring-loaded balancing system.
2. Strong construction featuring a metal load-bearing framework.

3. Release system with customised key.
4. The electronic control unit is housed in a protective plastic casing with easy access from the top.
5. Ready for "master-slave" mode for twin barrier operation.

IDEAL INSTALLATION HARRIER 4000R - SINGLE (SOLUTION A) OPPOSING BARRIER (SOLUTION B)

ITEM NUMBER	DESCRIPTION	€	Solution A	Solution B
41545/001	Harrier 4000R 230V barrier with on-board control unit and foundation plate included	1192,80	1	2
	Beam fixing flange (to be selected based on beam chosen) See Mandatory Accessories)		1	2
	Beam (to be selected based on beam type) -See Mandatory Accessories		1	2
	Spring (to be selected based on length beam chosen)		1	2
41580/052	FC HARRIER - Fork support	141,52	1	~
41923/009	RR SE - Unico 433.92 MHz superheterodyne receiver	88,67	1	1
41905/004	TM4 - 433.92 MHz four-channel transmitter	38,41	N	N
41812/008	ER12-24V - Pair of photocells	71,16	1	N
41830/055	CPC - PC column 12E H=110	57,37	N	N
41830/007	PC12E - Wall-mounted key-operated switch	27,81	N	N

N: Based on specific installation requirements

NOTE: To complete the system, it is possible to add a second pair of ER12-24V photocells

ITEM NUMBER	DESCRIPTION	€
41545/001	Harrier 4000R barrier with on-board control unit and foundation plate	1192,80

ITEM NUMBER	DESCRIPTION OF OPTIONAL ACCESSORIES	€
41580/052	FC - Fork support	141,52
41580/055	PP - Articulated swinging tip	135,32
41590/106	Aprimatic Stickers for Ø80 beam (pack 50 stickers)	60,84
41580/057	Kit skirt module 1.8m each	150,00
41545/050	Foundation plate	33,74

ITEM NUMBER	LED LIGHTS KIT AND RUBBER EDGE	€
41580/056.3	Shockproof rubber edge for beam L=3m	48,00
41580/056.4	Shockproof rubber edge for beamL=4m	64,00
41580/053.3	Led lights strip kit 6m for beam L=3m	150,00
41580/053.4	Led lights strip kiti 8m for beam L=4m	200,00

ITEM NUMBER	MANDATORY ACCESSORIES	€
41580/045	Fixing flange for H65 beam (AAP)	50,22
41580/046	Fixing flange for Ø80 beam Harrier 4000	74,19
	OVAL BEAM H65 (AAP) (Beams with predisposition of accessories installation)	
41580/040	- 4m long beam *	146,76
	Ø 80 BEAM:	
41522/001	- 3,0m long beam*	135,42

ITEM NUMBER	ACCESSORY DESCRIPTION - MANDATORY SPRING	€
41580/070	"White" Balance spring (for beam up to 3m)	51,39
41580/071	"Yellow" Balance spring (for beam up to 4m)	52,59

* see table for matching springs

HARRIER SPRING : CHOOSING THE RIGHT PRODUCT

Beam and accessory type	3 m	4 m
H65 beam (AAP)	41580/070	41580/071
H65 beam (AAP) with swinging tip or skirt	41580/071	41580/071
80Ø mm beam	41580/070	41580/071

NOTE: For the available safety and signalling devices and for installation accessories, see section "Control units and indicators" in this catalogue (refer to the initial index).

NOTA: All prices are subject to variation.

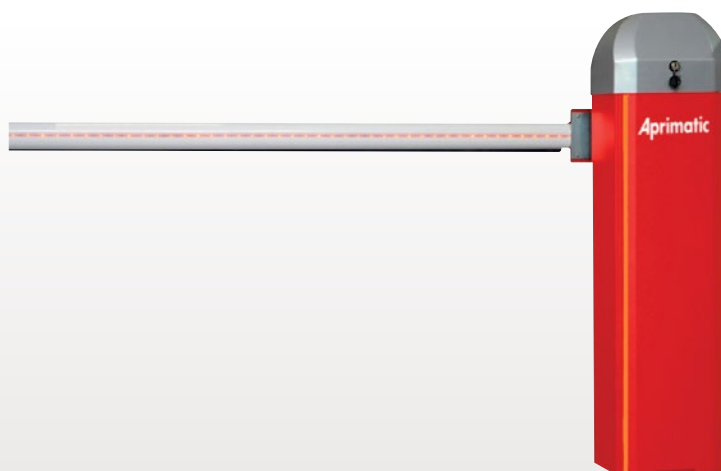

HARRIER 4000I

NEW

24
V_{CC}

i219

Electromechanical traffic barriers 24V, for vehicle passage from 3 to 5 m. Intensive use.

TECHNICAL DATA

MAIN POWER SUPPLY	230 V - 50 Hz
MOTOR POWER SUPPLY	24V
OPENING TIME	from 2 to max. 5 m
BEAM LENGTH	5 m max.
PROTECTION DEGREE	IP54
MAX. ABSORBED POWER	160 W
ACCESSORY MAX. ABSORBED CURRENT	6 A
OPERATING TEMPERATURE	-25°+70° C
NOMINAL TORQUE	200 Nm
ANTI-CRUSHING	YES
WEIGHT BARRIER	52 Kg

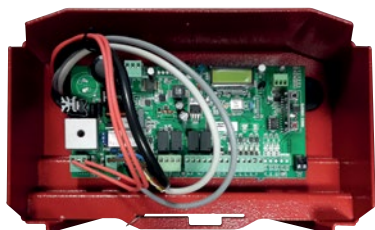

Easy access for wiring and configuration in the upper part of the barrier.



User-friendly electronics: no configuration is required for basic use. Parameters are easy to check and set.

Easy to install: simple installation and configuration. IT is only necessary to balance the spring.

Reduced dimensions and next-generation design: long and narrow shape.

High intensity of use: suitable for the control of vehicular access for medium/large parks, for intensive use

Main technical solutions adopted:

1. Super smooth action thanks to the spring-loaded balancing system.
2. Strong construction featuring a metal load-bearing framework.
3. Release system with customised key.

4. The electronic control unit is housed in a protective plastic casing with easy access from the top.
5. Ready for "master-slave" mode for twin barrier operation.

IDEAL INSTALLATION HARRIER 4000I - SINGLE (SOLUTION A) OPPOSING BARRIER (SOLUTION B)

ITEM NUMBER	DESCRIPTION	€	Solution A	Solution B
41580/001	Harrier 4000I 24V barrier with on-board control unit and foundation plate included	2011,72	1	2
	Beam fixing flange (to be selected based on beam chosen) See Mandatory Accessories)		1	2
	Beam (to be selected based on beam type)- See Mandatory Accessories		1	2
	Spring (to be selected based on length beam chosen)		1	2
41580/052	FC HARRIER - Fork support	141,52	1	~
41923/009	RR SE - Unico 433.92 MHz superheterodyne receiver	88,67	1	1
41905/004	TM4 - 433.92 MHz four-channel transmitter	38,41	N	N
41812/008	ER12-24V - Pair of photocells	71,16	1	N
41830/055	CPC - PC column 12E H=110	57,37	N	N
41830/007	PC12E - Wall-mounted key-operated switch	27,81	N	N

N: Based on specific installation requirements

NOTE: To complete the system, it is possible to add a second pair of ER12-24V photocells

ITEM NUMBER	DESCRIPTION	€
41580/001	Harrier 4000I barrier with on-board control unit and foundation plate	2011,72

ITEM NUMBER	DESCRIPTION OF OPTIONAL ACCESSORIES	€
41580/052	FC - Fork support	141,52
41580/055	PP - Articulated swinging tip	135,32
41590/106	Aprimatic Stickers for Ø80 beam (pack 50 stickers)	60,84
41580/057	Kit skirt module 1.8m each	150,00
41580/058	Joint for beam	120,00
41580/054	Articulatet kit for beam	296,95
41580/050	Foundation plate	45,79

ITEM NUMBER	LED LIGHTS KIT AND RUBBER EDGE	€
41580/056.3	Shockproof rubber edge for beam L=3m	48,00
41580/056.4	Shockproof rubber edge for beam L=4m	65,00
41580/056.5	Shockproof rubber edge for beam L=5m	80,00
41580/053.3	Led lights strip kit 6m for beam L=3m	150,00
41580/053.4	Led lights strip kit 6m for beam L=4m	200,00
41580/053.5	Led lights strip kit 6m for beam L=5m	250,00

ITEM NUMBER	MANDATORY ACCESSORIES	€
41580/045	Fixing flange for H100 beam (AAP)	56,16
41580/046	Fixing flange for Ø80 beam Harrier 4000	74,19
	OVAL BEAM H65 (AAP) (Beams with predisposition of accessories installation)	
41580/040	- 4m long beam *	146,76
41580/041	- 5m long beam *	167,77
	Ø 80 BEAM:	
41522/001	- 3,0m long beam *	135,42
41522/002	- 6,0m long beam * (to use up to 5m passage span)	255,59

ITEM NUMBER	ACCESSORY DESCRIPTION - MANDATORY SPRING	€
41580/070	"White" Balance spring (for beam up to 3m)	51,39
41580/071	"Yellow" Balance spring (for beam up to 4m)	52,59
41580/072	"Green" Balance spring (for beam up to 5m)	63,74

* see table for matching springs

HARRIER SPRING : CHOOSING THE RIGHT PRODUCT

Beam and accessory type	3 m	4 m	5 m
H65 beam (AAP)	41580/070	41580/071	41580/072
H65 beam (AAP) with swinging tip or skirt	41580/071	41580/071	41580/072
80Ø mm beam	41580/070	41580/071	41580/072

NOTA: All prices are subject to variation.



HARRIER 6000I / 8000I

NEW

24
V_{CC}

i219

Electromechanical
traffic barriers 230V,
for vehicle passage
from 6 to 8 m.
Intensive use.

TECHNICAL DATA	6000I	8000I
MAIN POWER SUPPLY	230 V - 50 Hz	230 V - 50 Hz
MOTOR POWER SUPPLY	24V	24V
OPENING TIME	8 s max.	8 s max.
BEAM LENGTH	6 m	8 m
PROTECTION DEGREE	IP54	IP54
MAX. ABSORBED POWER	200 W	200 W
ACCESSORY MAX. ABSORBED CURRENT	8 A	8 A
OPERATING TEMPERATURE	-25°+70° C	-25°+70° C
NOMINAL TORQUE	300 Nm	300 Nm
ANTI-CRUSHING	YES	YES
WEIGHT BARRIER	74 Kg	77 Kg





User-friendly electronics: no configuration is required for basic use. Parameters are easy to check and set.

Easy to install: simple installation and configuration. IT is only necessary to balance the spring.

Reduced dimensions and next-generation design: long and narrow shape.

High intensity of use: suitable for the control of vehicular access for medium/large parks, for intensive use.

Main technical solutions adopted:

1. Super smooth action thanks to the spring-loaded balancing system.
2. Strong construction featuring a metal load-bearing framework.
3. Release system with customised key.

4. The electronic control unit is housed in a protective plastic casing with easy access from the top.
5. Ready for "master-slave" mode for twin barrier operation.

IDEAL INSTALLATION HARRIER 6000I/8000I - SINGLE (SOLUTION A) OPPOSING BARRIER (SOLUTION B)

ITEM NUMBER	DESCRIPTION	€	Solution A	Solution B
41580/002	Harrier 6000I 24V barrier with on-board control unit and foundation plate included	2242,43	1	2
	Beam fixing flange (to be selected based on beam chosen) - See Mandatory Accessories)		1	2
	Beam (to be selected based on beam type) -See Mandatory Accessories		1	2
	Spring (to be selected based on length beam chosen)		1	2
41580/052	FC HARRIER - Fork support	141,52	1	~
41923/009	RR SE - Unico 433.92 MHz superheterodyne receiver	88,67	1	1
41905/004	TM4 - 433.92 MHz four-channel transmitter	38,41	N	N
41812/008	ER12-24V - Pair of photocells	71,16	1	N
41830/055	CPC - PC column 12E H=110	57,37	N	N
41830/007	PC12E - Wall-mounted key-operated switch	27,81	N	N

N: Based on specific installation requirements

NOTE: To complete the system, it is possible to add a second pair of ER12-24V photocells

ITEM NUMBER	DESCRIPTION	Beam length	€
41580/002	Harrier 6000I 24V	6m	2242,43
41580/003	Harrier 8000I 24V	8m	2438,00

ITEM NUMBER	DESCRIPTION OF OPTIONAL ACCESSORIES	€
41580/052	FC - Fork support	141,52
41580/055	PP - Articulated swinging tip	135,32
41590/106	Aprimatic Stickers for Ø80 beam (pack 50 stickers)	60,84
41580/057	Kit skirt module 1.8m each	150,00
41580/059	Joint for beam (AAG)	130,00
41580/051	Foundation plate	45,79

ITEM NUMBER	LED LIGHTS KIT AND RUBBER EDGE	€
41580/056.6	Shockproof rubber edge for beam L=6m	96,00
41580/056.8	Shockproof rubber edge for beam L=8m	130,00
41580/053.6	Led lights strip kit 12m for beam L=6m	300,00
41580/053.8	Led lights strip kit 12m for beam L=8m	400,00

NOTE: For the available safety and signalling devices and for installation accessories, see section "Control units and indicators" in this catalogue (refer to the initial index).

NOTA: All prices are subject to variation.

ITEM NUMBER	MANDATORY ACCESSORIES	€
41580/065	Fixing flange for H100 beam (AAP)	60,00
41580/047	Fixing flange for Ø80 beam Harrier6000-8000	75,00
	OVAL BEAM H65 (AAP) (Beams with predisposition of accessories installation)	
41580/060	6m long beam	212,99
41580/080	8m long beam (6m+2m wint joint)	327,50
	Ø 80 BEAM:	
41522/002	- 6,0m long beam (see table for spring matching)	255,59
41523/001	Ø80mm telescopic beam from 4.5m to 6m	326,95

ITEM NUMBER	SPRINGS	€
41580/071	"Yellow" Balance spring (for beam up to 6m with accessories)	52,59
41580/073	"Blue" Balance spring (for beam up to 6m)	76,50
41580/074	"Red" Balance spring (for beam up to 8m)	100,00

* see table for matching springs

HARRIER SPRING : CHOOSING THE RIGHT PRODUCT

Beam and accessory type	6 m	8 m
H100 beam (AAG)	41580/073	41580/073
H100 beam (AAG) with swinging tip or skirt	41580/073 + 41580/071	41580/073 + 41580/074
800 mm beam	41580/074	41580/073 + 41580/074



06.

CONTROL DEVICES AND INDICATORS

ELECTRONIC CONTROL UNIT

ACCESS CONTROL MEMORY
SYSTEM 433,92MHZ

INSTALLATION ACCESSORIES





ELECTRONIC CONTROL UNITS

Aprimatic control units ensure reliability and durability thanks to the careful design and selection of the best components available and offer the highest technological

content, together with a variety of features. Prestigious third-party laboratories perform compliance testing required for EC marking and certify the

compliance of the equipment with the requirements imposed by European standards for electrical safety and electromagnetic compatibility.





Top quality electronic and electromechanical components and careful circuit design for exceptional interference immunity.

Spike filters built onto the card for high protection against mains disturbances.

Voltage stabilisers dedicated to logic circuits and power on/reset circuits to protect against fluctuations and transient power failures.

Zero-crossing **power triacs** to minimise interference and to guarantee perfect operation and a long working life of the equipment.

Short circuit and overload **protection fuses** for 24Vdc transformers, motors and accessories.

Boards, circuits, power components and heat sinks all dimensioned to guarantee trouble-free operation even in continuous use at maximum nominal power.

Compact board size to leave plenty of room for wiring and to ensure easy installation and maintenance.

Numbered and mechanically polarised **removable terminal boards** to guarantee easy wiring and safe connections. Plug-in connectors for easy installation of receivers and optional boards.

Boxes fitted with locking devices operated by a special key supplied as standard, and seals with **IP55** protection degree for high resistance to atmospheric agents.





SWING GATE CONTROL UNITS				
	BUILT-IN	RSK24 2500	T4 POWER	BA230
RAIDER 2500		●		
AP424 24V		●		
AP423 230V				●
FLEXI	●			
FORTY				●
TWENTY				●
EM 73N			●	
ZT 70				●
ZT 71				●

SLIDE CONTROL UNITS				
	SC230	A888	8382L	BUILT-IN
ONDA 424				●
ONDA 624				●
ONDA623	●			
ONDA 800	●			
AT 80 E	●			
ONDA 2000-2001	●			
AT 86 T		●		
AT 88 T		●		
AT 90 T			●	
AT 92 T			●	

UP-AND-OVER CONTROL UNITS				
	T3 EC	T3 E	INTEGRATA	
ALZO	●			
AT 50		●		
GA-MATIC CF800			●	
GA-MATIC CF1000			●	

BARRIER CONTROL UNITS	
	BUILT-IN
HARRIER 4000R	●
HARRIER 4000I	●
HARRIER 6000I	●
HARRIER 8000I	●

**THE RANGE**

	ITEM NUMBER	DESCRIPTION	€
	41628/001	BA230 - Electronic control unit for swing gates with one/two electromechanical or hydraulic 230 Vac operators, with electronic slowdown and torque control, built-in receiver, compatibility with all Aprimatic receiver modules	226,80
	41626/001	SC230 - Electronic control unit for swing gates with electromechanical 230 Vac operator, built-in receiver, compatibility with all Aprimatic receiver modules	219,00
	41625/003	T3E - Electronic control unit for up-and-over doors and bars with one/two electromechanical or hydraulic 230 Vac operators	277,38
	41600/001	T4 POWER - Electronic control unit for swing gates with one/two electromechanical 24 Vdc operators	249,72

* Until stocks last

ACCESSORIES

ITEM NUMBER		€
41706/009	FR 220 - Mains filter for electronic control units to be used in case of mains disturbances	34,76

NOTE: All prices are subject to variation



CONTROL UNIT TECHNICAL SPECIFICATIONS

TECHNICAL DATA	BA230	SC230
POWER SUPPLY	Single phase 230 Vac (6% - 10%) - 50 Hz	
MOTOR VOLTAGE	230 Vac	230 Vac
OPERATING TEMPERATURE	-20° +70° C	-20° +70° C
STORAGE TEMPERATURE	-40° +85° C	-40° +85° C
RELATIVE HUMIDITY	90% max. (non condensing)	
PROTECTION DEGREE	IP 55	IP 55
INPUTS		
Opening/Start	Yes	Yes
Closing	~	~
Pedestrian Start / Partial opening	Yes	Yes
Stop	Yes	Yes
Standard safety (photocell)	Yes	Yes
Additional safety	Yes	Yes
Limit stop	~	Yes
prepared for motor control with encoder	Yes	Yes
OUTPUTS		
Motor	2	1
Flashing light	Yes	Yes
Indicator light	Yes	Yes
Electric lock	Yes	~
Courtesy light	~	~
Accessory 24 Vdc power supply	1 A	350mA
SPECIAL FUNCTIONS		
Limit stop slowdown	~	~
Electronic slowdown	Yes	Yes
Anti-crushing	~	Yes - with encoder
Electronic torque control	Yes	Yes
Motor braking	Yes	Yes
Built-in 433.92 MHz superheterodyne receiver	Yes	Yes
safety tests	Yes	Yes
OPERATING MODES		
Automatic standard	Yes	Yes
Automatic super	Yes	Yes
Automatic with Stop	~	Yes
Semi-automatic with Stop	Yes	Yes
Semi-automatic Open/Close	~	~
Dead man	~	~
SETTINGS		
Operating time	~	~
Pause time	Yes	Yes
Wing delay on closing	Yes	~
Braking delay	Yes	Yes
Torque adjustment	Yes	Yes
Slowdown	Yes	Yes

(1) With optional "Light Card"
 (2) With optional "LS Card"



TECHNICAL SPECIFICATIONS OF PROFESSIONAL CONTROL UNITS

TECHNICAL DATA	T3E	T4 POWER
POWER SUPPLY		Single phase 230 Vac (6% - 10%) - 50 Hz
MOTOR VOLTAGE	230 Vac	230 Vac
OPERATING TEMPERATURE	-20° +70° C	-20° +70° C
STORAGE TEMPERATURE	-40° +85° C	-40° +85° C
RELATIVE HUMIDITY		90% max. (non condensing)
PROTECTION DEGREE	IP 55	IP 55
INPUTS		
Opening/Start	Yes	Yes
Closing	Yes	~
Pedestrian Start / Partial opening	~	Yes
Stop	Yes	Yes
Standard safety (photocell)	Yes	Yes
Additional safety	Yes	Yes
Limit stop	Yes	~
OUTPUTS		
Motor	1	2
Flashing light	Yes	Yes
Indicator light	Yes	Yes
Electric lock	~	Yes
Courtesy light	Yes	Yes (1)
Accessory 24 Vdc power supply	300 mA	500 mA
SPECIAL FUNCTIONS		
Limit stop slowdown	Yes	Yes (2)
Electric slowdown	~	~
Anti-crushing	Yes	Yes
Electronic control of the torque	~	~
Motor braking	~	~
433 MHz built-in superheterodyne receiver	~	~
OPERATING MODES		
Automatic Standard	Sì	Sì
Automatic Super	~	~
Automatic with stop Stop	~	~
Semi-Automatic with stop	Sì	Sì
Semi-Automatic open/close	Sì	~
Dead man	Sì	~
SETTINGS		
Operating time	Yes	~
Pause time	Yes	Yes
Wing delay on closing	~	Yes
Braking delay	~	~
Torque adjustment	~	~
Slowdown	Yes	Yes

(1) With optional "Light Card"

(2) With optional "LS Card"



Elettroset and Elettrokkit:
flexible and easy use for any automation system

COMPATIBILITY WITH APRIMATIC OPERATORS

ELETTROSET FOR SLIDING GATES / ELETTROKIT

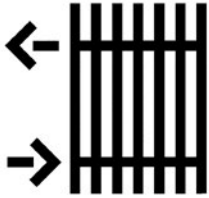

433.92 MHz sliding gate Elettroset
230 V 433.92 MHz Elettrokkit
24 V 433.92 MHz Elettrokkit

ONDA 424 ONDA 624	ONDA 623	ONDA 800	ONDA 801E	AT 80E	ONDA 2000	ONDA 2001
✓	•	•	✓	•	•	•
•	✓	✓	✓	✓	✓	✓

SWING GATE ELETTROSET / ELETTROKIT



433.92 MHz swing gate Elettroset
24 V 433.92 MHz Elettrokkit

TWENTY	FORTY	AP423 230V	ZT 70	ZT 71	FLEXI
•	•	•	•	•	•
✓	✓	✓	✓	✓	•

ELETTROKIT FOR TRAFFIC BARRIERS

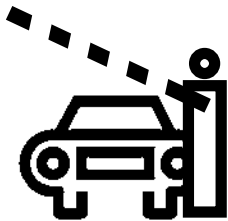

230 V 433.92 MHz Elettrokkit
24 V 433.92 MHz Elettrokkit

HARRIER 40001	HARRIER 60001	HARRIER 80001	HARRIER 4000R
✓	✓	✓	•
•	•	•	✓

Price kit 41615/801: **442,63** euro

The kit includes:

ES 433.92 MHZ SLIDING GATE ELETTROSET

ITEM NUMBER	DESCRIPTION
41626/001	- SC230 Electronic control unit with 433.92MHz built-in radio receiver
41929/003	- 433.92 MHz antenna
41905/004	- Two TM4 433.92 MHz four-channel transmitters
41840/006	- ET2N - 24V flashing light
41812/008	- ER 12 - 24V pair of photocells
41830/007	- PC12E Wall-mounted key-operated switch - Signal panel



NOTE: All prices are subject to variation



Price kit 41605/802: **418,71** euro

The kit includes:

ESB 433.92 MHZ SWING GATE ELETTROSET

ITEM NUMBER	DESCRIPTION
41628/001	- BA230 Electronic control unit with 433.92MHz built-in radio receiver
41929/003	- 433.92 MHz antenna kit
41905/004	- Two TM4 433.92 MHz four-channel transmitters
41840/006	- ET2N - 24 V flashing light
41812/008	- ER 12 - 24V pair of photocells
41830/007	- PC12E wall-mounted key-operated switch - Signal panel



Price kit 41700/800: **231,85** euro

The kit includes:

ELETTROKIT EKK - 230 V

ITEM NUMBER	DESCRIPTION
41929/003	- 433.92 MHz antenna kit
41905/004	- Two TM4 433.92 MHz four-channel transmitters
41841/009	- ET20N - 230 V flashing light
41812/008	- ER 12-24V Pair of photocells
41830/007	- PC12E Wall-mounted key-operated switch - Signal panel



Price kit 41700/801: **237,61** euro

The kit includes:

ELETTROKIT EKK - 24 V

ITEM NUMBER	DESCRIPTION
41929/003	- 433.92 MHz antenna kit
41905/004	- Two TM4 433.92 MHz four-channel transmitters
41840/006	- ET2N - 24V LED flashing light
41812/008	- ER 12-24V Pair of photocells
41830/007	- PC12E Wall-mounted key-operated switch - Signal panel

NOTE: All prices are subject to variation



ACCESS CONTROL MEMORY SYSTEM 433.92

MEMORY SYSTEM is the perfect radio access control solution for residential and industrial buildings, condominiums, car-parks, clubs, tourist ports and other community applications. Technology, design and special dedicated access control functions make of Memory System an indispensable tool for advanced installers wishing to attract new customers by guaranteeing maximum security. Memory System's access management functions make it far more than just another remote opening system and allow installations to be managed with far greater professionalism and skill.

4- and 14-KEY ROLLING CODE REMOTE CONTROLS

- A single code set from 72,000,000,000,000 possible combinations guarantees maximum user security.
- Attractive, stylish design in clear orange and red, and excellent ergonomics.

UNICO MEMORY SYSTEM RECEIVERS

Memory System receivers represent a unique hardware and software solution and can be expanded with up to 4 channels.

They are suitable for all installation types and all access control requirements.

- 24 Vdc / Vac power supply, low consumption (20 mA max. in stand by).
- 104 dBm sensitivity, range from 40 to 120 m, front end radio frequency input filter.
- Hopping / rolling code decoding system.
- Radio code self-learning, beeper and flasher for code recognition.
- Standard removable memory module for up to 496 different codes. Optional module for over 2,000 codes.
- Standard relay output and relay modules for up to 3 expansion channels with 4 operating modes: pulse, hold, step-by-step, and timer with programmable 1-255 second duration.

APRITool HAND-HELD CONFIGURATION TOOL

A portable hand-held configuration tool capable of installer code configuration, renewal, disabling and cancelling even wirelessly; active channel selective disabling for each individual code; access management configuration (base, easy, special, super); data storage on receiver memory modules; update download onto a PC.

APRIBASE1 CONFIGURATION BASE

A configuration base for remote controls, receivers and memory modules. For use in conjunction with Apricot Manager software or the Apritool configuration tool. Complete with serial cable for connection to a PC or to the Apritool configuration tool.

APRICOT MANAGER ACCESS MANAGEMENT SOFTWARE

Apricot Manager software allows installers to make full, simple and intuitive use of all Memory System access management functions (user identification, lost code cancellation, hierarchic access control, etc.). The powerful database also allows you to archive all installation data for easier maintenance and warranty management etc.



REMOTE CONTROLS AND RECEIVERS

MEMORY SYSTEM 433.92 MHZ			
	ITEM NUMBER	DESCRIPTION	€
	41905/004	TM4 - 433.92 MHz four-channel rolling code remote control	38,41
	41903/014	TR14 - 433.92 MHz 14-channel remote control with function keys that can be customised using the Apricot RC Customizer	282,63
	41923/009	RR SE - Unico 433.92 MHz Memory System receiver (narrow-band superheterodyne version) with built-in antenna	88,67
	41929/001	ANT433 - 433.92 MHz antenna with 4.5 m coax cable and ground connection to be used as external antenna for 41923/009 receiver	19,12
ACCESSORIES FOR UNICO MEMORY SYSTEM RECEIVER 41923/009			
	ITEM NUMBER	DESCRIPTION	€
	41923/052	CA41 - Expansion relay module for additional channel	22,01
	41923/053	CA43 - Expansion relay module for 3 additional channels	35,93
	41923/051	MM2 - Optional removable memory module up to 2,032 codes	101,99
	41923/059	CR44 - IP44 container for outdoor installation	9,83
	41706/007	CA2 - Expansion relay card (multiple package with 6 pcs.)	17,86

NOTE: All prices are subject to variation



PORTABLE HAND-HELD CONFIGURATION TOOLS

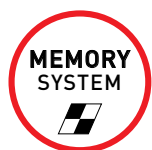

APRIBASE 1

CONFIGURATION TOOL AND CONFIGURATION BASE FOR REMOTE CONTROLS AND RECEIVERS

Customise Installer code and System code. Select access management functions: pulse, hold, step-by-step and timer with 1-255 s programmable duration. Configure codes in memory modules or internal buffers. Configure remote controls with code customisation.

Read remote controls. Identify, read, edit and transfer data to and from memory modules. Cancel and disable memory module codes. Edit memory module function parameters. Program remote controls to duplicate, replace and disable codes by radio. Transfer data to and from PC.

HAND-HELD CONFIGURATION TOOL

ITEM NUMBER	DESCRIPTION	€
41930/005	The APRITool hand-held configuration tool must always be combined with APRIBASE1	2.494,35
41930/001	Apribase 1 - Configuration base for memory modules and remote controls, complete with power unit and battery charger for configuration tool	1.385,47



41930/102

Configuration cable for use with the TM4 41905/004 transmitter

77,22

APRICOT SOFTWARE

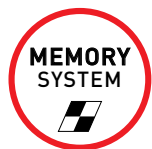
**APRICOT MANAGER**

is the software allowing to make full and simple use of all Memory System access management functions. It is also a very useful tool allowing the installer to store customer and system data, thus facilitating maintenance operations, warranty management etc. Using Apricot Manager does not require any particular IT skills. The window-based interface allows to perform all operations in a simple and intuitive way.

The software is supplied on a self-installing CD-ROM for PC with the following operating systems: Windows 95, 97, 2000, NT. Any prohibited or potentially dangerous operations that could compromise the integrity of stored data are protected against operator errors. Access to the application is protected by a password that can be customised by the user. Installation is protected with unique user number for each support.

COMMON ACCESSORIES

ITEM NUMBER	DESCRIPTION	€
41930/009	Apricot Manager, Windows XP version (multi-language) - Access control Software on self-installing CD-ROM only for PC with Windows XP operating system (No Notebook) always in combination with APRIBASE1	530,31



Note : Ask availability to Customer Service.
NOTE: All prices are subject to variation



OTHER ACCESS CONTROL SYSTEMS



PROXIMITY READERS



PR5
New access control reader with proximity-reader technology. The PR5 proximity reader works with the practical keychain Tag or ISO badge. PR5 is easily installed even on existing systems, replacing existing Aprimatic readers (CT/4, LB/4, ...) because it is mounted on the same mechanics.
Reading distance: 5 cm
Decoder connection: 3-wire bus.



TAG
Proximity keychain tag.
Reading distance 5-8 cm.

	ITEM NUMBER	DESCRIPTION	€
	41820/001	PR5 - Proximity reader always in combination with the DEC/A 41820/050 decoding card	137,36
	41820/051	Proximity keychain TAG*, reading distance 5-8 cm	9,83
	41820/053	Proximity ISO badge TAG*	9,22

* For multiple purchases, always consider 1 extra TAG to be used as a Master.

DECODER

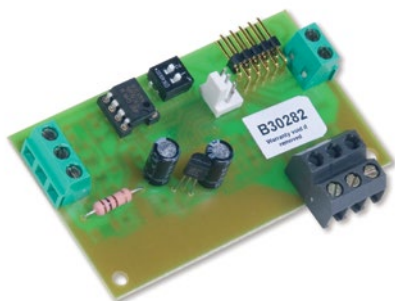

DEC/A
Decoder card with 256 codes for access control systems. Plug-in installation on Aprimatic control units. DEC/A is compatible with the PR5 proximity sensor; CT4 keypad and LB4 magnetic card reader. It replaces the previous range of Aprimatic decoders (DC/3 and DB/4).

TECHNICAL DATA

POWER SUPPLY	24 Vdc ± 15%
INSTALLATION	Plug-in
NUMBER OF STORABLE CODES	256
READER CONNECTION	3-wire bus
DIMENSIONS	mm 105x65x30

ITEM NUMBER	DESCRIPTION	€
41820/050	DEC/A - Access control decoder with 256 codes	85,77



NOTE: All prices are subject to variation



KEYBOARD COMBINATION LOCK



	ITEM NUMBER	DESCRIPTION	€
	41800/002	CT4 - Electronic keyboard combination lock with capacitive keypad for over 2 billion possible combinations, data transmission on serial cable between the keyboard and the decoding card ensures tamper-proof protection. Always in combination with the DEC/A 41820/050 decoding card.	114,75

CARD AND MAGNETIC KEY READERS

	ITEM NUMBER	DESCRIPTION	€
	41821/001	LB4 - Tamper-proof magnetic card reader with over 2 billion possible combinations, data transmission on a serial cable between the reader and the decoding card ensures tamper-proof protection. Always in combination with the DEC/A 41820/050 decoding card.	220,23
	41821/048	SB4/C - Coded magnetic card (badge)	5,20

* Item out-of stock. Request availability to back Office











ANTI-TAMPER KEY-OPERATED SWITCHES



	ITEM NUMBER	DESCRIPTION	€
	41830/006	PM12 - Two-contact metal key-operated switch for wall- or post-mounting	36,63
	41830/005	PC12 - Two-contact key-operated switch, accessories are available for recessed post- and wall-mounting and for external wall- and post-mounting	27,81
	41830/007	PC12E - Two-contact key-operated switch, accessories are available for recessed post and wall-mounting and for external wall and post-mounting	27,81

NOTE: All prices are subject to variation



OPTIONAL ACCESSORIES FOR PR5; CT4; LB4; PC12; PM12 AND PC12E

			LB4 41821/001	CT4 41800/002	PR5 41820/001	PC12 41830/005	PM12 41830/006	PC12E 41830/007
	€							
41830/051	46,68	H= 110 cm 	●	●	●	●		
41830/055	57,37	H= 110 cm 						●
41830/053	2,87		●	●	●	●		
41830/050	15,00		●	●	●	●		
41830/054	10,03		●	●	●	●		

	ITEM NUMBER	DESCRIPTION	€
	41812/051	Base plate for 41830/051 or 41830/055 post mounting (pack of 4 pcs)	11,32
	41830/052	Bracket for metal pillar connection complete with screws to be matched to 41830/050 or 41830/054 metal container (pack of 4 pcs)	5,20

FLASHING LIGHTS



Yellow light indicators always visible at a distance in all weather conditions. Made of polycarbonate, they have a high degree of mechanical resistance to impacts.

ITEM NUMBER	DESCRIPTION	€
41840/006*	ET 2N - 24 V LED flashing light	42,30
41841/009*	ET 20N - 230 V single flashing lamp	32,45
41841/001	ET 22 - 230 V double flashing lamp	62,59
41929/003	433.92 MHz antenna kit for ET2N and ET20N	18,48

* Sold without antenna kit

NOTE: All prices are subject to variation



METAL DETECTOR

	ITEM NUMBER	DESCRIPTION	€
	41801/004	230 V single channel Loop Detector	272,40
	41801/005	230 V two-channel Loop Detector	346,24

STRAIGHT EDGES



Straight edges consist of an aluminium support profile with a rubber profile containing the steel cable system for obstacle detection.

ITEM NUMBER	DESCRIPTION	€
41850/002	CF1M - 1.5 m straight safety edge	68,39
41850/003	CF2M - 2.0 m straight safety edge	75,33
41850/004	CF3M - 3.0 m straight safety edge	85,68
41850/001	CF3MS - 3.0 m straight safety edge (thin and specific for garage doors)	79,19

RADIO BAND



TBX 868 MHz





RU 868 MHz

Radio signalling devices of safety edges on automatic accesses. The Radio Band system establishes a constant dialogue between emitter and receiver at a frequency of 868 MHz, with continuous auto-test. Each receiver manages as many as 6 transmitters.

ITEM NUMBER	DESCRIPTION	€
41906/001	TBX 868 MHz - Radio Band transmitter	150,68
41926/001	RU 868 MHz - Radio Band receiver	170,96

OPTIONAL POWER UNITS

	ITEM NUMBER	DESCRIPTION	€
	41703/002	AL1 - 24 Vdc 500 mA power unit for independent control of electric locks, relays, CT4 keyboard combination lock, LB4 badge reader, with preset connection for DC/3 and DB/4 decoding cards	103,17
	41703/001	24 Vdc 250 mA power unit for safety devices and accessories - dimensions Ø 50 mm, h 30 mm, can be installed in 3-module flush-mounting boxes	46,93

NOTE: All prices are subject to variation



PHOTOCELLS

**ER12-24V - MINI PHOTOCELLS FOR WALL-MOUNTING**

The ER12-24V photocells, with 20-m maximum range, are designed to be welded onto a post or wall-mounted and require no recess. The elements are self-aligning and therefore need no adjustments.

The transmitter and receiver are infrared-modulated and therefore unaffected by sun disturbances or bright direct light. IP45 protection degree guaranteed by a special rubber seal that prevents water infiltrations.

ITEM NUMBER	DESCRIPTION	€
41812/008	ER12-24V - Modulated infrared photocells, 12-24 Vac power supply, for post- or wall-mounting	71,16

**ER2N - PHOTOCELLS FOR RECESSED MOUNTING**

ER2N photocells are equipped with an adjustment system that keeps them perfectly aligned. The modulated infrared beam makes them unaffected by sun disturbances or bright direct light.

ITEM NUMBER	DESCRIPTION	€
41811/001	ER2N - Modulated infrared photocells, 24 Vdc/Vac, for post mounting, recessed mounting or inside a container to be welded, max. range 40 m	95,62

REFLEX PHOTOCELLS

**REFLEX - PHOTOCELL WITH REFLECTION OF POLARISED LIGHT FOR AUTOMATIC GATES.**

Quick installation (on wall or support post) because it requires wiring only to one end of the gate; the round reflector must be secured at the same height as the photocell, on the other end of the gate. Extremely reliable, because it can detect even highly reflective objects,

such as mirrors or glossy surfaces. Extremely easy photocell alignment: thanks to the analogue pointing LED, finding the best efficiency point is easy. An optional accessory is available to protect the reflector from bumps and splashes.

ITEM NUMBER	DESCRIPTION	€
41810/002	REFLEX - Photocell with reflection of polarised light	97,94
41810/050	Reflector protection	12,95

TECHNICAL DATA

POWER SUPPLY	24 Vdc / Vac
MAX. ABSORBED POWER	3 W
MAX. RANGE RECEIVER RELAY CONTACT	1A - 24 Vdc for resistive loads; 0.5A - 24Vdc for non-resistive loads
INTERVENTION TIME	20 ms
MAX. OPERATING DISTANCE	nominal 12 m
OPERATING TEMPERATURE	-15° +70° C
RELATIVE HUMIDITY	< 90% non condensing
LIGHT REJECTION	20000 lux
PROTECTION DEGREE	IP 45
APPLICATION FIELD	For use in protected environments (indoors, under porches, etc.)

NOTE: All prices are subject to variation



PHOTOCELLS

**ER180B - BATTERY-POWERED
PHOTOCELLS FOR WALL-MOUNTING**

The ER180B photocells are equipped with lenses adjustable up to 180°. The TX transmitter is powered by 2 1.5V batteries (2 x AAA or LR03)

with a maximum duration of 30 months. The RX receiver is powered by a 12-24 Vac/dc current through the system's electronic control unit.

ITEM NUMBER	DESCRIPTION	€
41817/001	ER180B - Battery-powered photocells, 12-24Vac/dc, for wall-mounting, max. range 20 m	101,99

DESCRIPTION OF OPTIONAL ACCESSORIES FOR REFLEX, ER12-24V, ER2N PHOTOCELLS

		ER12-24V 41812/008	REFLEX 41810/002	ER2N 41811/001
	€			
41811/050	35,93			
Galvanised post for ER2N photocells (height 51 cm)				
41812/052	32,45			
Galvanised post for ER12-24V photocells (height 44 cm)				
41812/050	34,76			
Aluminium post for ER12-24V photocells (height 44 cm)				
41830/053	2,87			
Plastic container for recessed wall-mounting (pack of 6 pcs)				
41830/050	15,00			
PC12 Metal container to be welded				
41830/054	10,03			
Metal container to be welded (pack of 8 pcs)				





	ITEM NUMBER	DESCRIPTION	€
	41812/051	Foundation plate for 41811/050 or 41812/052 or 41812/050 posts (pack of 4 pcs)	11,32
	41830/052	Bracket for metal pillar connection complete with screws to be matched to 41830/050 or 41830/054 metal container (pack of 4 pcs)	5,20
	41812/054	ER12-24V 41812/008 fixing plates for corner- or wall- installation (pack of 10 pcs)	8,67

NOTE: All prices are subject to variation





INSTALLATION ACCESSORIES FOR OPERATORS

ELECTRIC LOCK AND ACCESSORIES FOR EXTERNAL SWING GATE OPERATORS

	ITEM NUMBER	DESCRIPTION	€
	41080/008	ES3 - 12 Vac Electric lock complete with ground striker plate (requires CL1 or CL2)	109,07
	41080/005	CL1 - Single-wing cylinder (keys included)	23,98
	41080/004	CL2 - Double-wing cylinder (keys included)	42,51
	41080/001	CB3 - Striker plate for ES3	8,93

INSTALLATION ACCESSORIES

	ITEM NUMBER	DESCRIPTION	€
	41080/003	Welding plate for vertical fitting of ES3	18,21
	41080/002	Welding plate for horizontal fitting of ES3	16,98

NOTE: All prices are subject to variation





INSTALLATION ACCESSORIES FOR OPERATORS

ACCESSORIES FOR EXTERNAL OPERATORS:

	ITEM NUMBER	DESCRIPTION	€
	41007/051	Front and rear bolt-on fixing plates	16,29

ACCESSORIES FOR UNDERGROUND OPERATORS:

	ITEM NUMBER	DESCRIPTION	€
	41056/056	TRA - Copper pipe with 8 mm ext. Ø (to be ordered in the desired length)	6,36
	41700/016	AprimOil (1 litre bottle) for hydraulic operators	16,96
	41700/014	AprimOil SPIRAX (1 litre bottle) for wet gear motors	22,49

SIGNAL PANEL



ITEM NUMBER	DESCRIPTION	€
APMA5845000	Aprimatic signal panel	3,56

NOTE: All prices are subject to variation



01. ROLLING SHUTTERS

AUTOMATION
SYSTEMS
FOR SHUTTERS
AND SUN BLINDS

TUBULAR MOTORS:
- REVOLUX SERIES

AUTOMATION
SYSTEMS
FOR ROLLING GATES

SERIES ROLLING SHUTTER MOTORS:
- RO-MATIC RS140
- RO-MATIC RS180



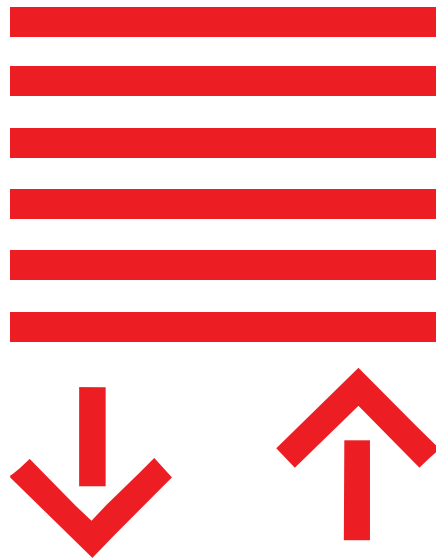

ROLLING SHUTTERS

TYPES

ROLLING SHUTTER MOTORS

Automation system used for standard rolling shutters or rolling shutters with container.



Revolux 35 series
Revolux 35 Wireless series
Revolux 45 series
Revolux 45 Wireless series
Revolux 59 series

BLIND MOTORS

Automation system used for technical fabric curtains, which can be installed in small premises as a sun-block, or as a projector screen. The same can be fitted on folding-arm sun blinds.

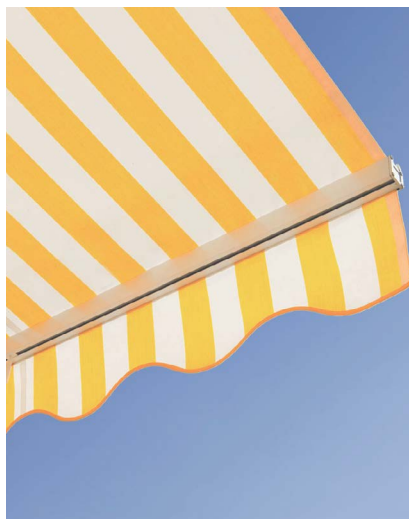

Revolux 35 series
Revolux 35 Wireless series
Revolux 45 series
Revolux 45 Wireless series
Revolux 59 series
Revolux 92 series

ROLLING GATE MOTORS

Automation system used for closing premises used for residential and commercial use.



RO-MATIC RS140 series
RO-MATIC RS180 series



SHUTTERS AND SUN BLINDS: TYPICAL SYSTEM COMPOSITION

1) Operator with and without on-board receiver: device that allows powering a rolling shutter or sun blind with an external power supply.

2) Accessories for installing/fixing the motor.

3) Transmitter: wireless equipment that transmits information to the control unit.

Tubular operator on rolling shutter

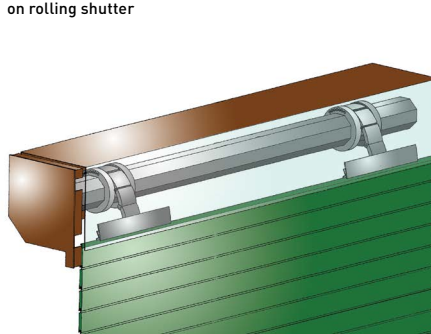

Tubular operator on sun blinds

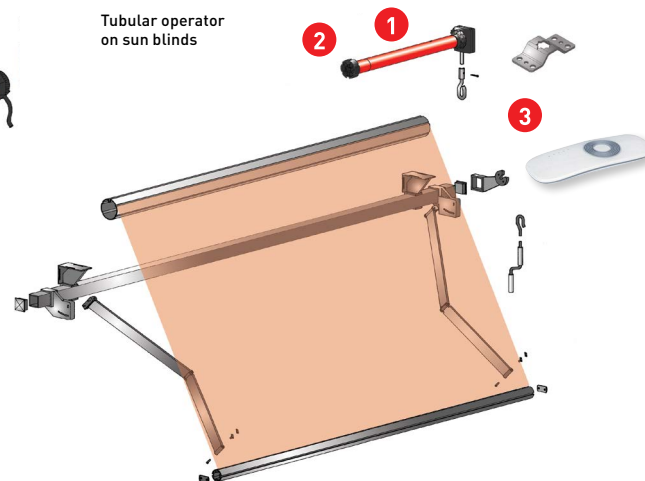

ROLLING GATES: TYPICAL SYSTEM COMPOSITION

1) Operator: device for shutter operation with an external power supply.
2) Control unit: electronic unit for handling the operator movement.
3) Transmitter: wireless equipment that transmits information to the control unit.

4) Antenna: device that increases the reception of the signals sent by the transmitter.
5) Flashing light: light signalling that the automation is moving.
6) Pair of photocells: safety devices stopping automation movement in the presence of obstacles.

7) Control unit: allows to activate the movement of the automation through a mechanical or electronic key.

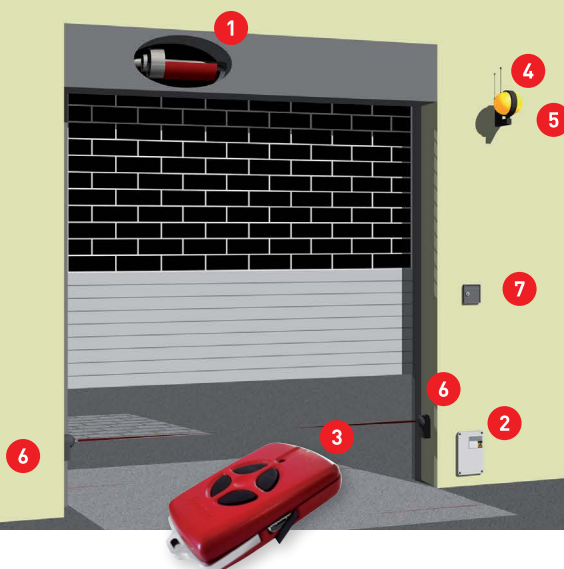



THE RANGE

Aprimatic's range of tubular motors for rolling shutters and sun blinds is extremely reliable, fast, and silent and offers performance to satisfy even the most demanding users. Available with wired or wireless controls.

SMS model: without emergency operation (ideal for rolling shutters)

CMS model: with emergency operation (ideal for sun blinds). Device allowing, with the necessary accessories, to perform manual operation with the relevant rod.

Models with mechanical limit stops: easy adjustment facilitated by the presence of 2 mechanical settings on the motor head.

Models with electronic limit stops: limit stop adjustment via electric pulse



REVOLUX TUBULAR MOTORS

Tubular motors for rolling shutters and sun blinds.



ROLLER KIT REVOLUX



SERIES 35 TUBULAR MOTORS WITHOUT EMERGENCY OPERATION



SERIES 45S SHORT TUBULAR MOTORS WITHOUT EMERGENCY OPERATION



SERIES 45 TUBULAR MOTORS WITHOUT EMERGENCY OPERATION



SERIES 45 TUBULAR MOTORS WITH EMERGENCY OPERATION



SERIES 59 TUBULAR MOTORS WITHOUT EMERGENCY OPERATION



SERIES 59 TUBULAR MOTORS WITH EMERGENCY OPERATION



SERIES 92 TUBULAR MOTORS WITH EMERGENCY OPERATION



SERIES 92 TUBULAR MOTORS WITHOUT EMERGENCY OPERATION



RO-MATIC RS140 / RS180

New series 92 motors: the best solution for the automation of rolling gates or mesh gates (weighing up to max. 350 kg).

Operator for rolling gates, for residential use.



NEW WIRELESS SYSTEMS



The entire range of Aprimatic Revolux, known for its performance and reliability, is now available in a wireless version, with built-in receiver.

Available new MP version tubular motors, with built-in receiver for the management of the movement of adjustable shutters.



REVOLUX
WIRELESS
SERIE **45** ((•))



REVOLUX
WIRELESS
SERIE MP* **45** ((•))

RADIO CONTROLS FOR ((•))
REVOLUX **WIRELESS**
TUBULAR MOTORS

Revolux wireless series radio control to manage up to 5 tubular motors



REVOLUX
WIRELESS
SERIE **35** ((•))



*MP Multiposition - motor with 3 limit switch for the management of the movement of adjustable shutters, with integrated receiver.



CHOOSING THE RIGHT PRODUCT ROLLING SHUTTER AUTOMATION SYSTEMS

$$\text{WEIGHT} = \frac{\text{Nominal motor torque (Nm)}}{\text{Lifting lever (m)}}$$

The nominal motor torque in Nm (Newton metre) is indicated on the motor label. The lifting force is obtained by adding the radius of the winding roller (R1 in the drawing) and half the thickness of the shutter (R2 in the drawing) or half the length of the rope supporting the applied weight.

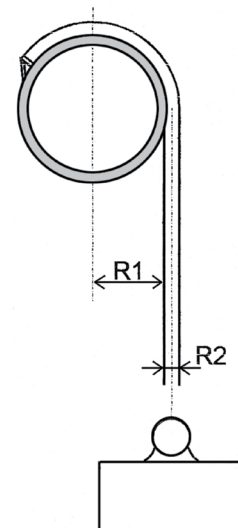

EXAMPLE IN METRES

Motor rated torque 45 Nm
 Pipe diameter 60 mm - R1 = 30 mm (0.030 m)
 Shutter thickness 10 mm - R2 = 5 mm (0.005 m)

$$\text{WEIGHT} = \frac{45 \text{ Nm}}{0,030 \text{ m} + 0,005} = \frac{45 \text{ Nm}}{0,035 \text{ m}} = 1285 \text{ N} \quad 9,81 \text{ N} = 1 \text{ kg} \quad \rightarrow \quad \text{WEIGHT} = \frac{1285 \text{ Nm}}{9,81} = 131 \text{ kg}$$

This motor can lift a free weight of 131 kg. However, application on window frames and rolling shutters requires safety coefficients of up to 50%. Therefore the maximum weight that can be lifted by the motor must be divided in half, and thus is 65 kg.

The tables to the side allow the selection of a motor in relation to the diameter of the winding roller and the weight of the rolling shutter. The weight of the rolling shutter in kg can be obtained by multiplying the area by the weight per m² of the material it is made of.

WARNING

The weights shown in the tables are calculated with a 50% margin (considering friction, winding diameter increase, etc.). Oversizing or downsizing the motor is not recommended.

WINDING MATERIAL	Kg for m ²
ALUMINIUM WITH POLYURETHANE FOAM	3,5
ALUMINIUM WITH HD POLYURETHANE FOAM	4,8
PVC	6,0
WOOD	8,5
EXTRUDED ALUMINIUM	9,0
STEEL WITH POLYURETHANE FOAM	9,5
STEEL WITH HD POLYURETHANE FOAM	10,5
STEEL	11,0

ROLLER WEIGHT (Kg)	WINDING ROLLER Ø (mm)			
	Ø 40 mm	Ø 60 mm	Ø 70 mm	Ø 97 / Ø 108 mm
5 Kg	Red	Orange	Orange	
10 Kg	Red	Orange	Orange	
15 Kg	Red	Orange	Orange	
20 Kg	Red	Orange	Orange	
25 Kg		Orange	Orange	
30 Kg		Orange	Orange	
35 Kg		Orange	Yellow	
40 Kg		Yellow	Yellow	
45 Kg		Yellow	Yellow	
50 Kg		Yellow	Light Green	
55 Kg		Yellow	Light Green	
60 Kg		Light Green	Light Green	
80 Kg		Light Green	Light Green	
85 Kg		Light Green	Light Green	
90 Kg		Light Green	Green	
95 Kg			Green	
100 Kg			Green	
105 Kg			Green	
110 Kg			Blue	
130 Kg			Blue	
135 Kg			Blue	
140 Kg			Blue	
150 Kg			Blue	
300 Kg				Purple
350 Kg				Purple

KEY

Red	10 Nm	Yellow	30 Nm	Green	80 Nm	Blue	120 Nm
Orange	20 Nm	Light Green	50 Nm	Light Blue	100 Nm	Purple	230 Nm

NOTE: Winding and friction coefficients included.

ROLLING SHUTTER AUTOMATION SYSTEMS

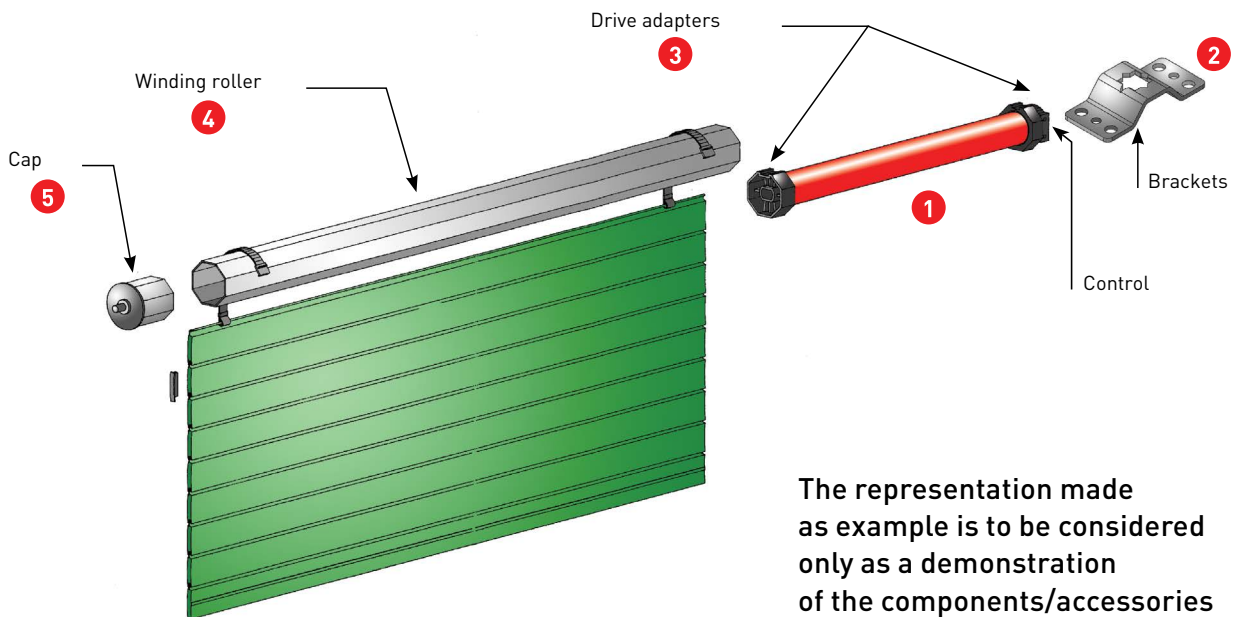

The representation made as example is to be considered only as a demonstration of the components/accessories needed to automate a rolling shutter.

MINIMUM CONFIGURATION - TUBULAR MOTOR WITHOUT EMERGENCY OPERATION

Ref.	Component	Notes	Page
1	Tubular motor	Revolux 35 series Motors (models from 6Nm to 10Nm) Revolux 45 series Motors (20Nm - 30Nm - 50Nm models) Revolux 59 series Motors (80Nm - 100Nm - 120Nm models) Revolux 92 series Motors (230Nm model)	133 134 137 138
2	Motor fixing accessories	Revolux 35 series Revolux 45 series Revolux 59 series Revolux 92 series	133 136-137 138 146
3	Pipe adapters	Revolux 35 series Revolux 45 series Revolux 59 series Revolux 92 series	133 136 145 138

OPTIONAL ACCESSORIES

Ref.	Component	Notes	Page
4	Octagonal pipe		139
5	Cap with round adjustable pivot		139

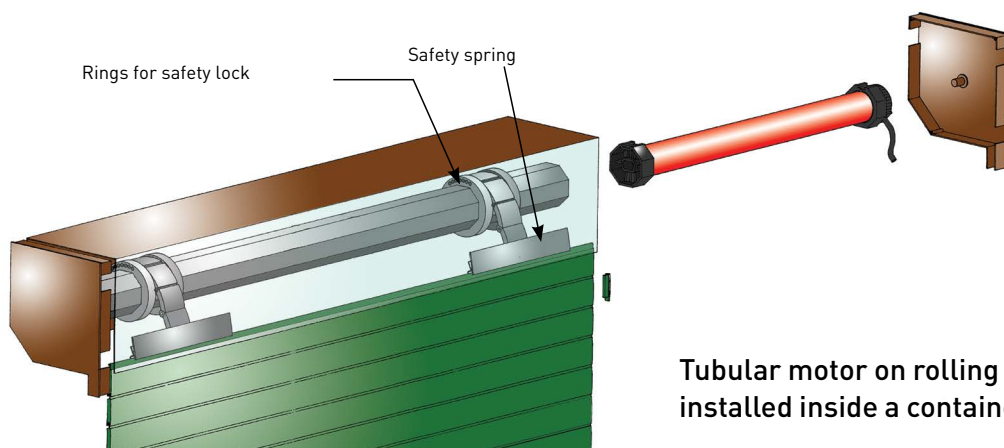

Tubular motor on rolling shutter installed inside a container



AUTOMATION SYSTEMS FOR BLINDS

CHOOSING THE RIGHT PRODUCT

AUTOMATION SYSTEMS FOR BLINDS

50 mm DIAMETER AND ROUND OGIVE ROLLER

NUMBER OF ARMS	ARM PROTRUSION (m)						
	1,5 m	2 m	2,5 m	3 m	3,5 m	4 m	5 m
2	20 Nm	30 Nm	30 Nm	30 Nm	30 Nm	30 Nm	50 Nm
4	30 Nm	30 Nm	30 Nm	50 Nm	50 Nm	50 Nm	~
6	30 Nm	30 Nm	50 Nm	50 Nm	~	~	~
8	50 Nm	50 Nm	~	~	~	~	~

NOTE: Winding and friction coefficients included.

70 mm DIAMETER AND ROUND OGIVE ROLLER

NUMBER OF ARMS	ARM PROTRUSION (m)						
	1,5 m	2 m	2,5 m	3 m	3,5 m	4 m	5 m
2	20 Nm	30 Nm	30 Nm	30 Nm	30 Nm	50 Nm	50 Nm
4	30 Nm	30 Nm	30 Nm	50 Nm	50 Nm	50 Nm	80 Nm
6	30 Nm	50 Nm	50 Nm	50 Nm	80 Nm	80 Nm	100 Nm
8	50 Nm	50 Nm	80 Nm	80 Nm	100 Nm	120 Nm	120 Nm

NOTE: Winding and friction coefficients included.

78 mm DIAMETER AND ROUND OGIVE ROLLER

NUMBER OF ARMS	ARM PROTRUSION (m)						
	1,5 m	2 m	2,5 m	3 m	3,5 m	4 m	5 m
2	20 Nm	30 Nm	30 Nm	50 Nm	50 Nm	50 Nm	80 Nm
4	30 Nm	50 Nm	50 Nm	50 Nm	50 Nm	50 Nm	80 Nm
6	50 Nm	50 Nm	50 Nm	80 Nm	80 Nm	100 Nm	120 Nm
8	80 Nm	80 Nm	80 Nm	80 Nm	100 Nm	120 Nm	~

NOTE: Winding and friction coefficients included.

KEY

10 Nm	30 Nm	80 Nm	120 Nm
20 Nm	50 Nm	100 Nm	230 Nm



AUTOMATION SYSTEMS FOR BLINDS

Tubular operator on sun blinds

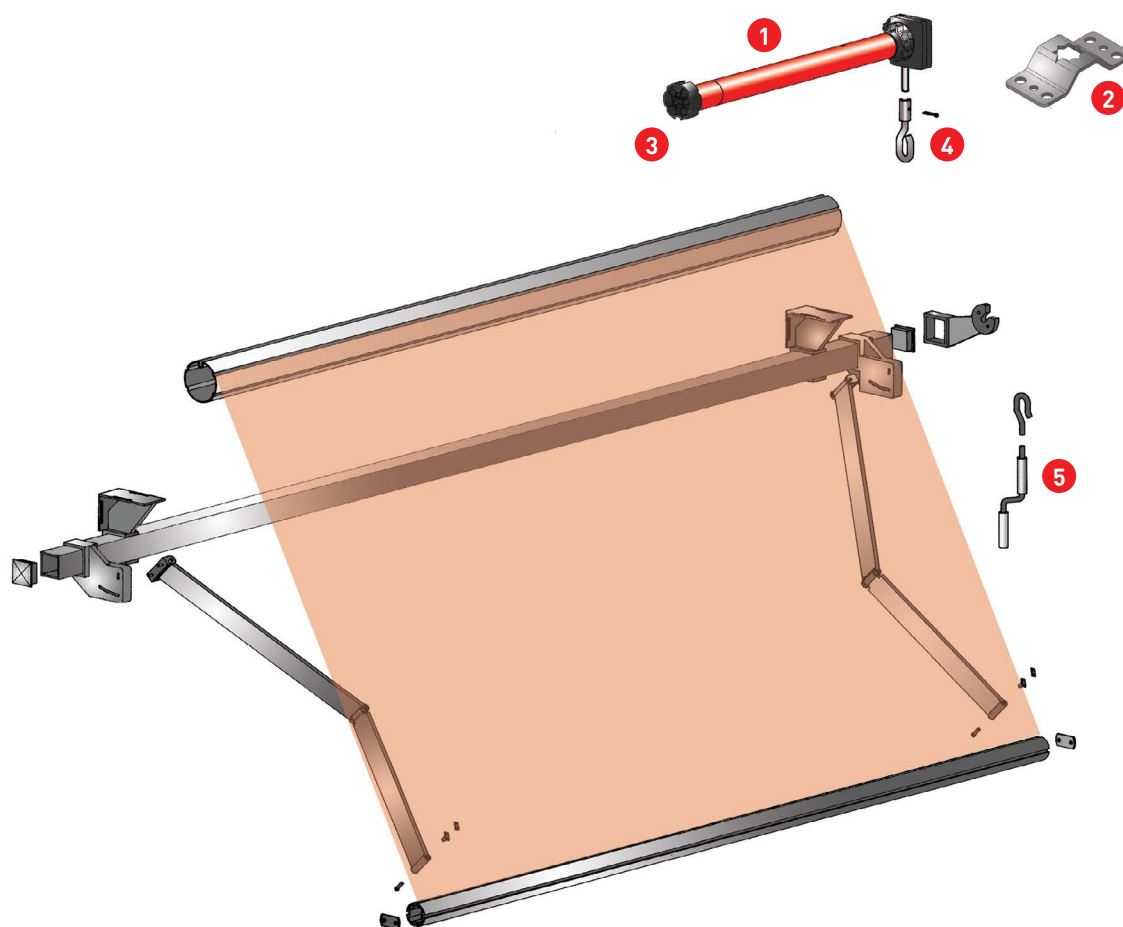

MINIMUM CONFIGURATION - TUBULAR MOTOR WITHOUT EMERGENCY OPERATION

Ref.	Component	Notes	Page
1	Tubular motor	Revolux Series 35 Motors (models from 6Nm to 10Nm) Revolux Series 45 Motors (20Nm - 30Nm - 50nm models) Revolux 59 Series Motors (80Nm - 100Nm - 120Nm models)	133 133-134-135 137
2	Motor fixing accessories	Revolux 35 series Revolux 45 series Revolux 59 series	133 136-137 138
3	Pipe adapters	Revolux 35 series Revolux 45 series Revolux 59 series	133 136 137
4	Accessories for emergency operation	Revolux 45M series Revolux 59M series	136 138

OPTIONAL ACCESSORIES

Ref.	Component	Notes	Page
5	Rod for manual emergency operation		139



REVOLUX TUBULAR MOTORS



Tubular motors for rolling shutters and sun blinds.



The motors can be combined with ADI control units, thus allowing the creation of fully-automated systems even with radio controls.

The wide availability of adapters and installation accessories allows to meet any application requirement.

3 automation kits are available for 30 kg, 60 kg and 90 kg shutters respectively, complete with accessories for installation.

The motors of the series 45, 59 and 92 are also available in CSM versions, i.e., equipped with emergency operation for manual opening in case of power supply failure.

Engine equipped with a 1.9 m cable for electrical connection. A simple device allows easy and accurate limit stop adjustment.

TECHNICAL DATA

SERIES	MODEL (S without emergency operation) (M with emergency operation)	TORQUE (Nm)	POWER (W)	SPEED (rpm)	DIAMETER (Ø)
35	35S 10Nm/17	10	121	17	35
	35S 6Nm/28F	6	121	28	35
45	45S 20Nm - 45M 20Nm	20	145	15	45
	45S 30Nm - 45M 30Nm	30	191	15	45
	45S 50Nm - 45M 50Nm	50	191	12	45
59	59S 80Nm - 59M 80Nm	80	298	15	60
	59S 100Nm - 59M 100Nm	100	305	12	60
	59S 120Nm - 59M 120Nm	120	305	9	60
92	92S 230Nm - 92M 230Nm	230	602	12	92

For all 45 and 59 series models, the operating time is 4 minutes.

ROLLER KIT REVOLUX



MOTORS WITHOUT EMERGENCY OPERATION AND MECHANICAL LIMIT STOPS

ITEM NUMBER	KIT DESCRIPTION	Max. weight	€
43302/802	ROLLER KIT 30 kg (45S-20Nm)	Ø 60 35 kg	178,79
43302/803	ROLLER KIT 60 kg (45S-30Nm)	Ø 60 56 kg	191,03
43302/804	ROLLER KIT 90 kg (45S-50Nm)	Ø 60 90 kg	210,24
The kits include			
Revolux 45S tubular motor (20Nm-30Nm or 50Nm version)			
43380/156	Octagonal adapter - Ø60		5,30
43380/057	Bracket with square shaft 10 for direct insertion in existing walls		13,10
43380/083	Support with square shaft 10		6,39

NOTE: All prices are subject to variation



SERIES 35 TUBULAR MOTORS WITHOUT EMERGENCY OPERATION*

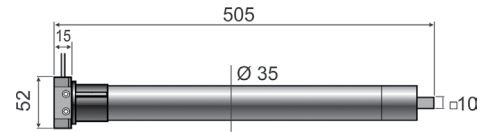

MOTOR WITHOUT EMERGENCY OPERATION AND MECHANICAL LIMIT STOP

ITEM NUMBER	DESCRIPTION	Max. weight**	€
43300/001	REVOLUX 35S 10Nm	Ø 40 20 kg	142,11
43300/002	REVOLUX 35S 6Nm	Ø 40 20 kg	142,11

** see Table on page 128



Mod.	A mm
10	593,5

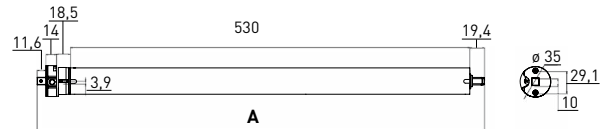





WIRELESS MOTOR WITHOUT EMERGENCY OPERATION AND ELECTRONIC LIMIT STOPS

ITEM NUMBER	DESCRIPTION	€
(••) 43800/001	REVOLUX WIRELESS 35SMS 10Nm 35mm diameter without manual emergency operation and with electronic limit stops. Built-in receiver.	193,05



DESCRIPTION OF SERIES 35 ACCESSORIES

ADAPTERS	ITEM NUMBER	DESCRIPTION	€
	43380/087	Octagonal for 40 mm roller	4,06
	43380/115	Round for 40 mm roller	2,89

ACCESSORIES	ITEM NUMBER	DESCRIPTION	€
	43380/077	Square shaft	2,89
	43380/082	Support kit with square shaft	6,39
	43380/091	Standard side support	4,06

NOTE: All described motors, except for the REVOLUX WIRELESS models, can be combined with ADI control units - See the "Home Automation" section of this catalogue (refer to the initial index).

(*) To complete the tubular motor installation, add an adapter to be chosen based on rolling shutter or blind winding roller, and a support to be chosen based on installation type. See the relevant pages on adapters and accessories for item selection.

NOTE: All prices are subject to variation

TUBULAR MOTORS

SERIES 45 TUBULAR MOTORS WITHOUT EMERGENCY OPERATION*

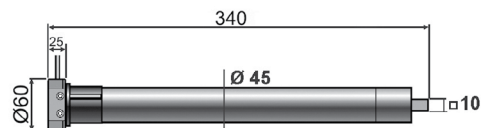

MOTOR WITHOUT EMERGENCY OPERATION AND MECHANICAL LIMIT STOP

ITEM NUMBER	DESCRIPTION	Max. weight**	€
43302/011	REVOLUX 45S 10Nm	Ø 60 20 kg	189,00

45S Short tubular motor is suitable for applications on small screens or shutters.

** see Table on page 128

SERIES 45 TUBULAR MOTORS WITHOUT EMERGENCY OPERATION*



Mod.	A mm
20	466
30	536
50	536

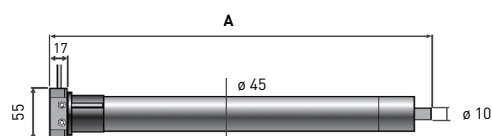

MOTOR WITHOUT EMERGENCY OPERATION AND MECHANICAL LIMIT STOP

ITEM NUMBER	DESCRIPTION	Max. weight**	€
43302/001	REVOLUX 45S 20Nm	Ø 60 35 kg	152,58
43302/002	REVOLUX 45S 30Nm	Ø 60 55 kg	167,14
43302/003	REVOLUX 45S 50Nm	Ø 60 88 kg	189,87

** see Table on page 128



Mod.	A mm
20	756,4
30	786,4
50	786,4

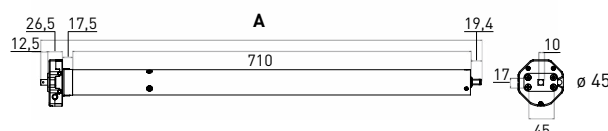

WIRELESS MOTOR WITHOUT EMERGENCY OPERATION AND ELECTRIC LIMIT STOP

ITEM NUMBER	DESCRIPTION	€
43801/001	(⊙) REVOLUX WIRELESS 45SMS 20Nm 45mm diameter without manual emergency operation and with electronic limit stops. Built-in receiver.	209,98
43801/002	REVOLUX WIRELESS 45SMS 30Nm 45mm diameter without manual emergency operation and with electronic limit stops. Built-in receiver.	230,06
43801/003	REVOLUX WIRELESS 45SMS 50Nm 45mm diameter without manual emergency operation and with electronic limit stops. Built-in receiver.	244,61



WIRELESS MULTIPOSITION MOTOR WITHOUT EMERGENCY OPERATION - 3 ELECTRIC LIMIT STOP

ITEM NUMBER	DESCRIPTION	€
43802/002	(NEW) 45mm diameter without manual emergency operation - 3 electronic limit stops to management of the movement of adjustable shutters, with integrated receiver.	229,00
43802/003	(NEW) 45mm diameter without manual emergency operation - 3 electronic limit stops to management of the movement of adjustable shutters, with integrated receiver.	239,00

NOTE: All described motors, except for the REVOLUX WIRELESS models, can be combined with ADI control units - See the "Home Automation" section of this catalogue (refer to the initial index).

(*) To complete the tubular motor installation, add an adapter to be chosen based on rolling shutter or blind winding roller, and a support to be chosen based on installation type. See the relevant pages on adapters and accessories for item selection.

NOTE: All prices are subject to variation



SERIES 45 TUBULAR MOTORS WITH EMERGENCY OPERATION*



Mod.	A mm
20	628
20/26	698
30	698
50	698

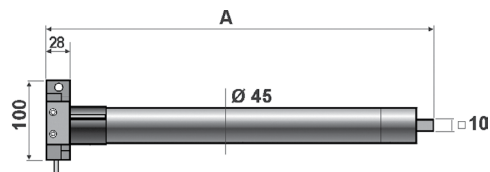

MOTOR WITH EMERGENCY OPERATION AND MECHANICAL LIMIT STOP

ITEM NUMBER	DESCRIPTION	Max. weight**	€
43310/005	REVOLUX 45M 20Nm	Ø 60 35 kg	198,01
43310/006	REVOLUX 45M 30Nm	Ø 60 55 kg	225,98
43310/007	REVOLUX 45M 50Nm	Ø 60 88 kg	256,85

** see Table on page 128



Mod.	Amm
20	685
30	740
50	740

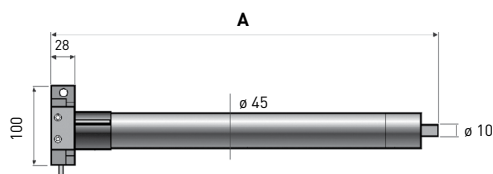

WIRELESS MOTOR WITH EMERGENCY OPERATION AND MECHANICAL LIMIT STOPS

(••)	ITEM NUMBER	DESCRIPTION	€
	43810/001	REVOLUX WIRELESS 45CMS 20Nm 45mm diameter with manual emergency operation and mechanical limit stops. Built-in receiver.	266,78
	43810/002	REVOLUX WIRELESS 45CMS 30Nm 45mm diameter with manual emergency operation and mechanical limit stops. Built-in receiver.	302,46
	43810/003	REVOLUX WIRELESS 45CMS 50Nm 45mm diameter with manual emergency operation and mechanical limit stops. Built-in receiver.	326,67



RADIO CONTROLS FOR REVOLUX WIRELESS TUBULAR MOTORS



(••)	ITEM NUMBER	DESCRIPTION	€
	43901/001	1-channel radio control for Revolux wireless tubular motors Radio control for one tubular motor	44,23
	43901/005	5-channel radio control for Revolux wireless tubular motors Radio control for up to 5 tubular motors	58,20



NOTE: All described motors, except for the REVOLUX WIRELESS models, can be combined with ADI control units - See the "Home Automation" section of this catalogue (refer to the initial index).







[*] To complete the tubular motor installation, add an adapter to be chosen based on rolling shutter or blind winding roller, and a support to be chosen based on installation type. See the relevant pages on adapters and accessories for item selection.

NOTE: All prices are subject to variation







TUBULAR MOTORS

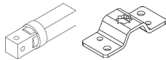

DESCRIPTION OF ADAPTERS FOR SERIES 45 (SMS-CMS) MOTORS

	ITEM NUMBER	DESCRIPTION	€
	43380/156	Octagonal for 60 mm roller	5,30
	43380/161	Octagonal for 70 mm roller (for 45S-50, 45M-50 motors)	6,64
	43380/064	Ogive for 70 mm roller	14,54
	43380/059	Ogive for 78 mm roller	12,54
	43380/063	Round for 50 mm roller	7,67
	43380/058	Bonfanti-Gaviota	9,59
	43380/060	ZF54 adapter	7,67

DESCRIPTION OF ACCESSORIES FOR SERIES 45 SMS MOTORS

	ITEM NUMBER	DESCRIPTION	€
	43380/078	Revolux 45S Square shaft	2,89
	43380/083	Revolux 45S Support kit with square shaft	6,39
	43380/124	Direct fixing bracket	9,89
	43380/092	Revolux 45S standard side support	4,06
	43380/107	Revolux 45S threaded-hole support kit with square shaft	4,06
	43380/108	Revolux 45S adjustable support kit with square shaft	16,38

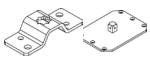
DESCRIPTION OF ACCESSORIES FOR SERIES 45 CMS MOTORS

	ITEM NUMBER	DESCRIPTION	€
	43380/079	Revolux 45M square shaft	6,39
	43380/084	Revolux 45M Support kit with square shaft	6,39
	43380/116	Hexagonal 7 mm eyelet kit	6,39

NOTE: All prices are subject to variation

**DESCRIPTION OF COMMON ACCESSORIES FOR SERIES 45 MOTORS**

	ITEM NUMBER	DESCRIPTION	€
	43380/057	Adjustable support - 45S and 45M	13,10
	43380/068	Support with release - 45S and 45M	13,10
	43380/109	Square shaft plain support - 45S and 45M	3,24
	43380/110	Adjustable support - 45S and 45M	7,64
	43380/111	Wall support - 45S and 45M	8,20
	43380/119	One-position container bracket - 45S and 45M	6,40
	43380/101	Two-position container bracket - 45S and 45M	6,39

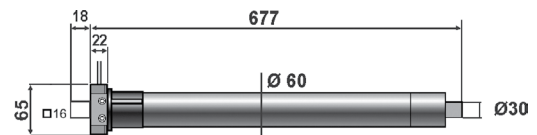
SERIES 59 TUBULAR MOTORS WITHOUT EMERGENCY OPERATION***MOTOR WITHOUT EMERGENCY OPERATION AND WITH MECHANICAL LIMIT STOP**

ITEM NUMBER	DESCRIPTION	Max. weight**	€
43320/001	59S-80	Ø 70 105 kg	252,18
43320/002	59S-100	Ø 70 139 kg	264,42
43320/003	59S-120	Ø 70 150 kg	291,79

** see Table on page 128

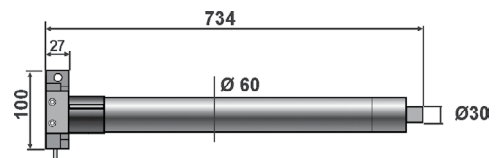
SERIES 59 TUBULAR MOTORS WITH EMERGENCY OPERATION***MOTOR WITH EMERGENCY OPERATION AND WITH MECHANICAL LIMIT STOP**

ITEM NUMBER	DESCRIPTION	Max. weight**	€
43330/001	59M-80	Ø 70 105 kg	311,02
43330/002	59M-100	Ø 70 139 kg	343,63
43330/003	59M-120	Ø 70 150 kg	374,50

** see Table on page 128

DESCRIPTION OF ADAPTERS FOR SERIES 59 (SMS-CMS) MOTORS

	ITEM NUMBER	DESCRIPTION	€
	43380/088	Octagonal for 70 mm roller	6,48
	43380/104	Ogive for 78 mm roller	12,66
	43380/105	Ogive for 85 mm roller	14,07

(*) To complete the tubular motor installation, add an adapter to be chosen based on rolling shutter or blind winding roller, and a support to be chosen based on installation type. See the relevant pages on adapters and accessories for item selection.



NOTE: All prices are subject to variation

TUBULAR MOTORS

DESCRIPTION OF ACCESSORIES FOR SERIES 59 SMS MOTORS

	ITEM NUMBER	DESCRIPTION	€
	43380/085	Revolux 59S standard support	11,06

DESCRIPTION OF ACCESSORIES FOR SERIES 59 CMS MOTORS

	ITEM NUMBER	DESCRIPTION	€
	43380/081	Revolux 59M Square shaft	6,39
	43380/086	Revolux 59M Support kit with square shaft	7,57

DESCRIPTION OF COMMON ACCESSORIES FOR SERIES 59 MOTORS

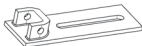
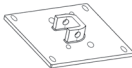
	ITEM NUMBER	DESCRIPTION	€
	43380/099	Adjustable support - Revolux 59S and 59M	8,11
	43380/100	Wall support - Revolux 59S and 59M	8,11

SERIES 92 TUBULAR MOTORS WITHOUT EMERGENCY OPERATION*

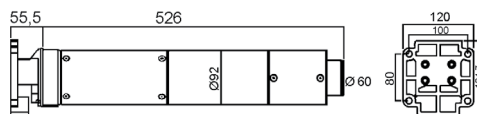

MOTOR WITHOUT EMERGENCY OPERATION AND WITH MECHANICAL LIMIT STOP

ITEM NUMBER	DESCRIPTION	Max. weight**	€
43340/001	92S-230	Ø 92 350 kg	530,59

** see Table on page 128

SERIES 92 TUBULAR MOTORS WITH EMERGENCY OPERATION*

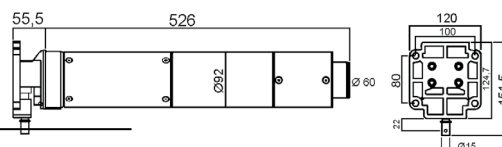



MOTOR WITH EMERGENCY OPERATION AND WITH MECHANICAL LIMIT STOP

ITEM NUMBER	DESCRIPTION	Max. weight**	€
43345/001	92M-230	Ø 92 350 kg	612,13

** see Table on page 128

DESCRIPTION OF COMMON ACCESSORIES FOR SERIES 92 MOTORS











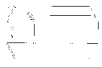
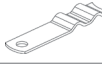
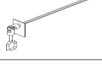



	ITEM NUMBER	DESCRIPTION	€
	43380/118	Round for Ø 108 mm roller	28,36
	43380/125	Round for Ø 97 mm roller	30,28
	43380/131	Hook for series 92M	8,00

[*] To complete the tubular motor installation, add an adapter to be chosen based on rolling shutter or blind winding roller, and a support to be chosen based on installation type. See the relevant pages on adapters and accessories for item selection.

NOTE: All prices are subject to variation



COMMON ACCESSORIES

DESCRIPTION OF COMMON ACCESSORIES FOR ALL TUBULAR MOTORS			
	ITEM NUMBER	DESCRIPTION	€
	43380/094	Octagonal pipe Ø 60 (in 3 m bars)	27,30
	43380/095	Octagonal pipe Ø 70 (in 3 m bars)	49,15
	43380/066	Masonry camp	4,06
	43380/072	90° 4-hole articulation with 7 mm hexagonal rod eyelet L= 250 mm*	37,51
	43380/071	45° 2-hole articulation with 7 mm hexagonal rod eyelet L= 400 mm*	43,37
	43380/093	45° articulation with joint**	30,58
	43380/106	Linear joint **	5,22
	43380/089	Articulated joint **	6,39
	43380/090	Hook for steel rod L=81 mm **	8,71
	43380/112	Hook for steel rod L=108 mm **	7,99
	43380/096	Rod for emergency manual operation L=150 mm*	27,27
	43380/070	Rod with hook and articulated handle L=150 mm*	46,96
	43380/097	End piece with adjustable round pin for Ø 60 mm octagonal pipe	10,03
	43380/098	End piece with adjustable round pin for Ø 70 mm octagonal pipe	10,61
	43380/113	End piece for Ø 60 mm octagonal pipe	4,51
	43380/114	End piece for Ø 70 mm octagonal pipe	15,99
	43380/073	Safety spring spring for Ø 60 octagonal pipe	31,44
	43380/076	Safety spring spring for Ø 70 octagonal pipe	31,90

* Accessories specific for series 45M and 59M with emergency operation.

** Accessories specific for series 59M only.

NOTE: All prices are subject to variation

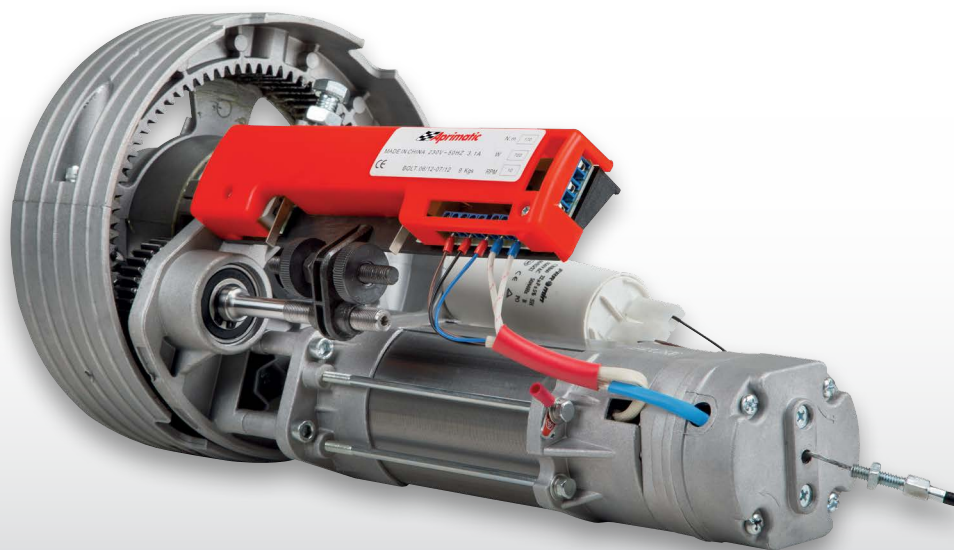

RO-MATIC RS140 / RS180

RO-MATIC RS140 / RS180

Operator for rolling gates for residential use.

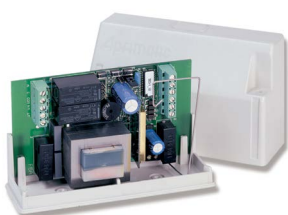

M230S

RO-MATIC RS RS140 / RS180 (reversible) for rolling gates with 48/60 mm pole and 200/220 mm spring holder is a cost-effective solution for quick and easy installation of rolling gates up to 140 kg (RO-MATIC RS 140 model) and 180 kg (RO-MATIC RS 180 model). An electrical

TECHNICAL DATA	RO-MATIC 140	RO-MATIC 180
POWER SUPPLY	230 V	230 V
ABSORBED CURRENT	2,5 A	3,1 A
ABSORBED POWER	520 W	650 W
NOMINAL TORQUE	140 Nm	180 Nm
	130 Nm (vers. EB)	170 Nm (vers. EB)
MAX. LIFTING FORCE	140 kg	180 kg
REV/1°	10 n	10 n
CAPACITOR	18 µF	22 µF
OPERATING TEMPERATURE	-20° C	-20° +85° C
ROLLING GATE MAX. HEIGHT	6 m	6 m
PROTECTION DEGREE	IP30	IP30

brake is available as accessory.
Mechanical limit stop adjustment.

M230S is an electronic control unit with built-in receiver, compatible with all Aprimatic 433.92 MHz remote controls, easy to install and put in service.

It can be connected to control and safety devices (max. accessory absorption: 300 mA) and is also equipped with 4 control modes and configuration of pause/operation times. Outdoor strongboxes for recessed or wall installation available.



TYPICAL SYSTEM

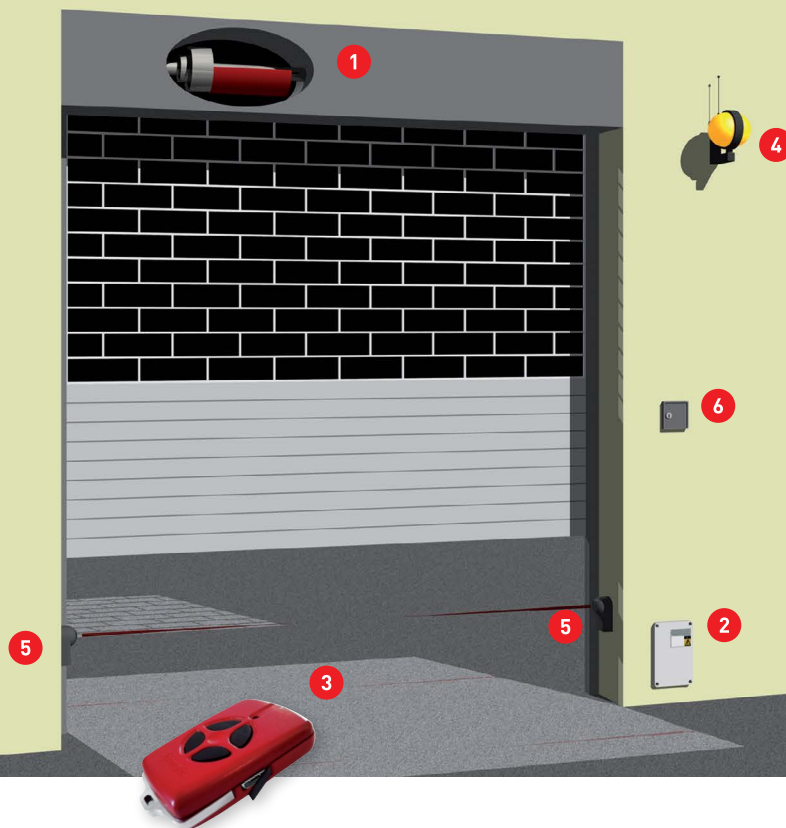

KEY	
1	Operator
2	Electronic control unit
3	Transmitter
4	Flashing light
5	Pair of photocells
6	Control device: key-operated switch / presence reader / keyboard combination lock / card reader / magnetic keys

ITEM NUMBER	RO-MATIC RS 140 DESCRIPTION	€
43364/001	RO-MATIC RS140 140 kg gear motor without electrical brake	273,06
43364/002	RO-MATIC RS140 EB 140 kg gear motor with electrical brake	305,43

ITEM NUMBER	RO-MATIC RS 180 DESCRIPTION	€
43364/003	RO-MATIC RS180 180 kg gear motor without electrical brake	287,89
43364/004	RO-MATIC RS180 EB 180 kg gear motor with electrical brake	325,29

ITEM NUMBER	ACCESSORIES	€
43364/050	Electrical brake (with 5m steel cable)	55,17
41704/002	CS - Recessed strongbox (with up/down button and electrical brake release)	74,19
41704/004	CSP - ROLLI Wall-mounted outdoor strongbox with up/down button	61,43
41704/005	ROLLI wall-mounted selector (with open/close button)	58,52



ITEM NUMBER	DESCRIPTION OF COMMON ACCESSORIES	€
43665/015	M230S - Electronic control unit for rolling gates	116,48
41812/008	ER 12-24V - Pair of photocells (optional)	71,16
41841/009	ET20N - 230 V flashing light (needed if the opening is on road side)	32,45
41905/004	TM4 - 433.92MHz four channel transmitter	38,41

NOTE: All prices are subject to variation



02.

SIDE-HUNG SHUTTERS

BUONGIORNO

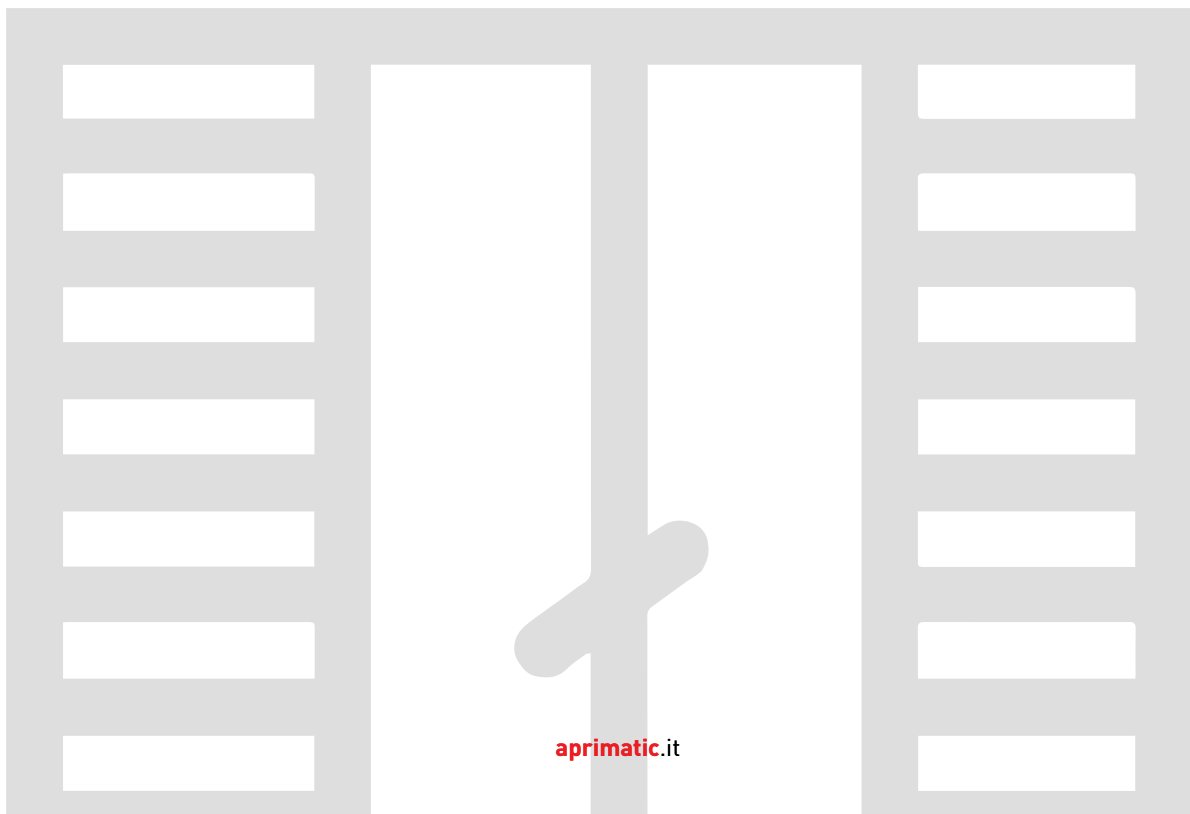

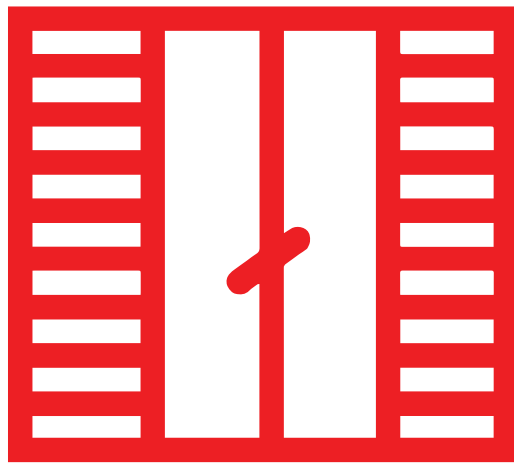



BUONGIORNO

i220

Electromechanical operator
for side-hinged shutters.

TECHNICAL DATA

POWER SUPPLY	230 Vca
MOTOR POWER SUPPLY	24 Vcc
MOTOR POWER	4,2 W
MAX. NOMINAL TORQUE	40 Nm
ELECTRIC LOCK	Internal
CLUTCH	Mechanical
OPERATING TIME	18 sec. for 180°

INSTALLATION DATA

	1 WING	2 WING
MIN. WINDOW WIDTH	43 cm	86 cm
MAX. WINDOW WIDTH	80 cm	155 cm
MAX. WING AREA	1,8 m ²	1,75 m ² x 2
MAX. WING WEIGHT	80 kg	50 kg x 2



NOTE: Frictions are included in the weights.

**Maximum reliability and great flexibility.**

Buongiorno is an automation system for side-hinged shutters. It can be used with any type of window including those fitted with security grates and mosquito screens. It consists of an aluminium beam which acts as a support for the gear motor (two in two-wing applications) and a PVC guard. The beam and guard can be cut to size to enable application with shutters of varying sizes. **Buongiorno** is easy to install without modifying the existing shutters or carry out masonry work.

Absolute comfort.

Buongiorno enables you to open and close the shutters in your home without opening the windows simply by pressing a button.

Buongiorno is ideal for opening and closing your shutters in winter, in cold weather, in summer, even if your windows have mosquito screens or are difficult to reach.

Security and durability.

Buongiorno is fitted with an electronic clutch that behaves intelligently depending on the absorbed current. The shutter stops if it meets an obstacle during movement thus protecting the user and the gear motor. Thanks to this device, the installer does not have to make any limit stop adjustments. In the event of mains power supply failure, the user can open or close the shutter immediately without unlocking it. An electric lock can also be fitted on demand for increased security.

IDEAL SINGLE-WING INSTALLATION

ITEM NUMBER	DESCRIPTION	Q.ty	€
43400/802	BUONGIORNO SINGLE-WING KIT		551,29
	The package includes:		
	BUONGIORNO single-wing automation with centralised control device	1	
	Two "T" compass levers (RH and LH)	1	
	Cover L = 800 mm	1	

IDEAL DOUBLE-WING INSTALLATION

ITEM NUMBER	DESCRIPTION	Q.ty	€
43400/801	BUONGIORNO DOUBLE-WING KIT		861,32
	The package includes:		
	BUONGIORNO double-wing automation system	1	
	Two "T" compass levers (RH and LH)	1	
	Cover L = 1500 mm	1	

ITEM NUMBER	ACCESSORIES	Notes	€
43400/055	Curved lever with ambidextrous guide	Standard two-handed lever	62,48
43400/052	Compass "R" RH lever	Compact RH lever	45,44
43400/053	Compass "R" LH lever	Compact LH lever	45,44
43400/056	Compass "T" RH lever	Compact RH lever with heavy-duty bracket	51,12
43400/057	Compass "T" LH lever	Compact LH lever with heavy-duty bracket	51,12
43400/054	Bracket KIT for BUONGIORNO reverse application	Accessories for installation	34,76
43400/059	BUONGIORNO Electric lock unit	Electric security lock driven by control unit	92,25

NOTA: All prices are subject to variation.



03.

WINDOWS AND DOMES

WI-MATIC ATC300E
OM2
APRICOLOR VARIA
ST 450N
APRILINEARE DUO-TRY SYSTEM
520/600RF - 520/700RF

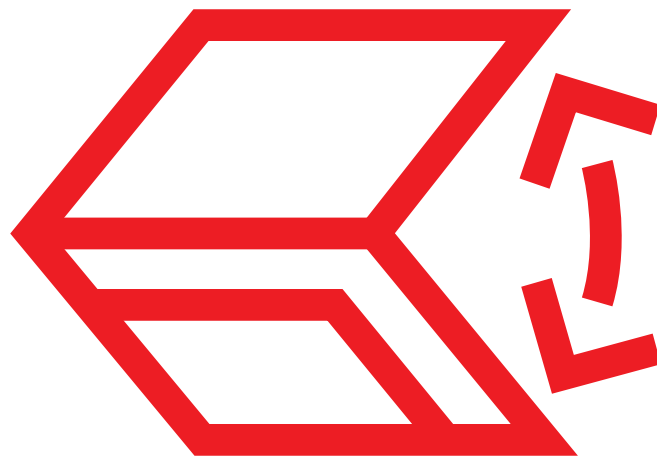

03. Windows and domes





INDUSTRIAL APPLICATIONS

CHOOSING THE RIGHT PRODUCT



WI-MATIC

O2M

VARIA

VARIA T

ST 450 N

APRILINEARE
DUO SYSTEMAPRILINEARE
TRY SYSTEMAPRILINEARE
SPEEDY

Outward-opening



Bottom-hinged

Bottom-hinged L >
1.6 m

Pivot-hinged

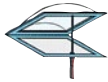
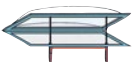

Small domes

Small aligned
domes L < 1 mLarge domes
max 120 kg

Shed

Aligned shed and
outward-openingOutward-opening
and large shed L > 1.6 m

Vertical sun blinds

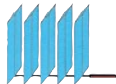

Jalousie windows

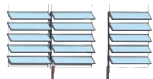

POSSIBLE CONFIGURATIONS

I

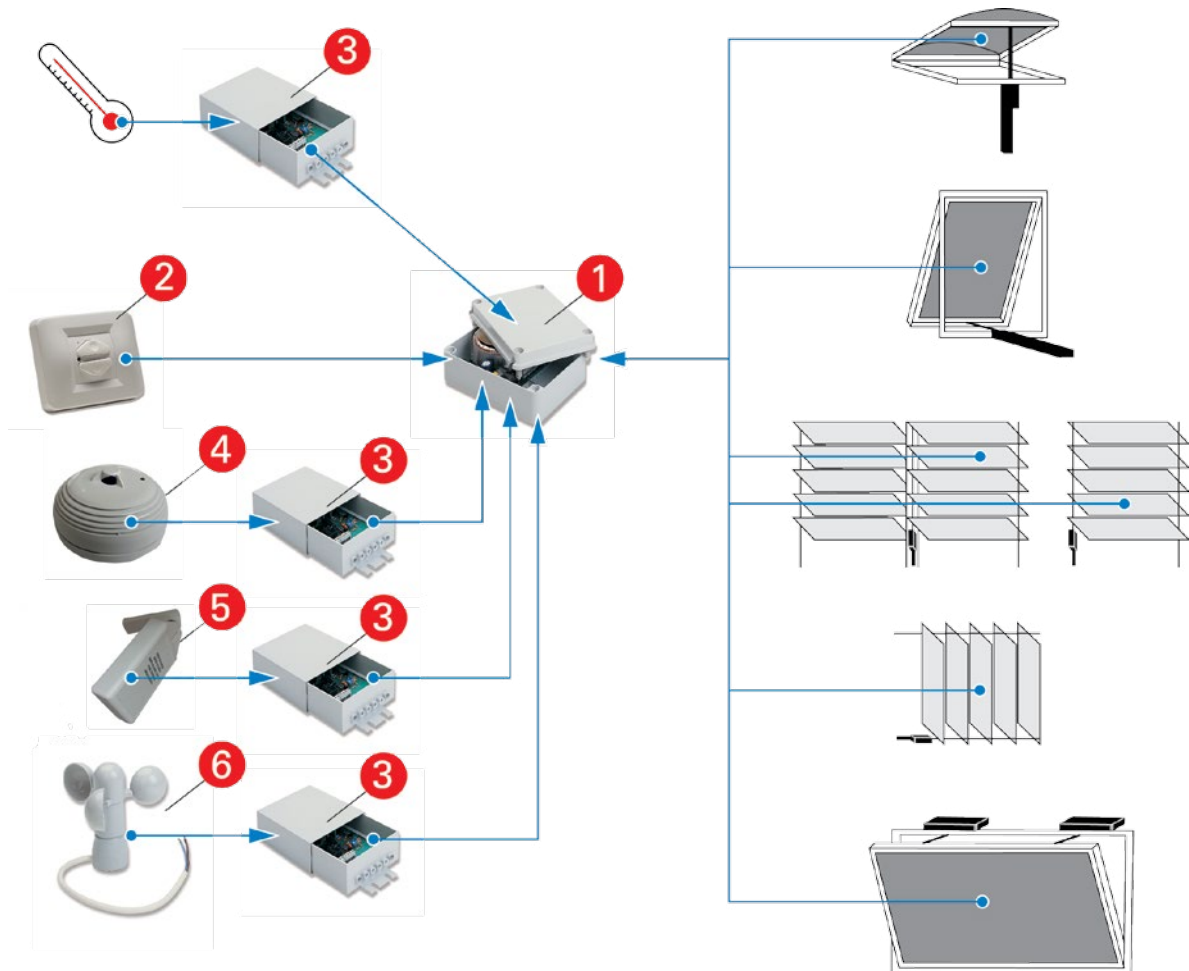

- 1 24 V - 230 V control unit
- 2 Switch
- 3 Weather unit
- 4 Smoke/heat detector
- 5 Rain sensor
- 6 Anemometer



WI-MATIC ATC300E

NEW

IP42

230V

Electromechanical operator for windows with double layer chain, ideal for outward-opening windows.

TECHNICAL FEATURES

POWER SUPPLY	100-240 Vca 50/60 Hz
ABSORBED CURRENT	0,15 A
RATED POWER	28 W
PUSH/PULL FORCE	250 N / 250 N
SPEED	10 mm/s
ADJUSTABLE STROKES FROM	100-400 mm
TEMPERATURE	-20°+60°
SIZE OPERATOR	(LxHxP) 460 x 42 x 56 mm
SIZE WINDOWS	1600 mm MAX
IP CLASS	IP42
PARALLEL CONNECTION	Yes, with 1 motor for each frame
OPERATOR WEIGHT	1.8KG





Wide voltage 100-240Vca power input, suitable for all country's different requests.

Rocker brackets for long runs even on small frames. They also allow the operator suitable to a wide range of applications.

The race is easily adjusted through a simple rotation from the outside of the operator so you don't need to open anything.

Adjustable running, from 100 up to 400mm

Double layers stainless metal chain alloy steel that ensure maximum strength.

Very smooth running
Applications bottom hinged or roof-domes bracket available separately.

Slim dimensions and compact shape



make this product easy to integrate with the window frame regardless of its thickness or design.

Aluminum casing with oxidation treatment satin to give maximum strength and aesthetics. Operator quiet thanks to the extremely robust structure that prevents vibration.

Special surface treatment to give an excellent resistance to oxidation. Excellent finishes too.

ITEM NUMBER	DESCRIPTION	STROKE mm	POWER SUPPLY	€
43509/015	WI-MATIC ATC300E with bracket for outward-opening applications included	400 mm	230 Vca	166,95

ACCESSORIES

	ITEM NUMBER	DESCRIPTION			€
	43509/050	Bottom hinged bracket	-	-	8,40
	43509/051	Bracket for Roof-domes window application	-	-	9,00

NOTE: All prices are subject to variation.



O2M

IP54

i 231

i 221

Electromechanical operator for windows with double chain, ideal for outward-opening windows, bottom-hinged windows and domes.



TECHNICAL DATA	24 Vdc
POWER SUPPLY	24 Vdc
ABSORBED POWER	50 W
ABSORBED CURRENT	2 A
THRUST FORCE	350 N (stroke 150 mm) 250 N (stroke 250 mm) 100 N (stroke 380 mm)
TRACTION FORCE	350 N
ADJUSTABLE STROKES	150 mm, 250 mm, 380 mm, special stroke (0÷380mm)
SHIFTING SPEED	24 mm/s
OPERATING TEMPERATURE	-5° +55° C
FRONT ADJUSTMENT	max. 10 mm
PARALLEL CONNECTION	YES (max 1 operator per window)
OVERLOAD PROTECTION	100° C
DIMENSIONS	(LxHxP) 340x40x80 mm
LIMITS OF USE	non-intensive (continuous operation MAX 4 min)
PROTECTION DEGREE	IP54
OPERATOR WEIGHT	1,2 Kg



Is a flexible, powerful and reliable product. These features make it unique in the market of window operators.

The special fixing device enables the installer to easily adjust the position of the operator on the frame.

Thanks to its thrust force and double chain, it can push and pull very heavy windows.

A dedicated software allows to reset the closing point automatically every 50 opening and closing operations. Thus, the window's heat insulation and soundproofing properties are not compromised.



The highest protection degree in its category, IP54, is a guarantee of good operation even for applications that are significantly exposed to atmospheric agents.

Smaller dimensions and a compact shape make this product easy to integrate with the window frame regardless of its thickness or design.

OPERATORS CHAIN POWER 24V

ITEM NUMBER	DESCRIPTION	Max. stroke mm	Power supply	€
43492/001	O2M RAL9005 black (with accessories)	380	24 Vcc	168,65
43492/002	O2M RAL 7040 grey (with accessories)	380	24 Vcc	168,65
43492/003	O2M RAL9010 white (with accessories)	380	24 Vcc	175,61

NOTE: The O2M range includes fixing accessories for OUTWARD-OPENING and BOTTOM-HINGED windows.

ITEM NUMBER	DESCRIPTION		€
43493/050	SLIM brackets for black O2M (package with 5 pairs)		20,85
43493/051	Black skylight O2M brackets		11,01
43493/052	Grey skylight O2M brackets		11,01
43493/053	White skylight O2M brackets		11,01

NOTE: for motor control unit selection, please refer to the "Home automation" chapter.

NOTE: All prices are subject to variation.



VARIA



VARIA T

Installation of the operator bracket to the counter-frame



Installation of the chain coupling to the mobile wing



Installation of the apricolor varia operator to the counter-frame



APRICOLOR VARIA

i222

Chain operator for bottom-hinged and outward-opening windows.

TECHNICAL DATA

POWER SUPPLY	230 Vca - 24 Vcc
ABSORBED POWER	150 W - 40 W
ABSORBED CURRENT	0,8A in ca/1,8 in cc
THRUST FORCE	150 N
TRACTION FORCE	300 N
ADJUSTABLE STROKES	from 90 to 400 mm
SHIFTING SPEED	40 mm/s
FRONT ADJUSTMENT	max. 10 mm
PARALLEL CONNECTION	YES
OVERLOAD PROTECTION	100° C (only 230 V versions)
CAPACITOR	4 µF
BUILT-IN RELAY	YES
LIGHT INDICATOR	YES
REMOVABLE TERMINAL BOARD	YES
PROTECTION DEGREE	IP20
OPERATOR WEIGHT	1.7 Kg



NOTE: Use of the Varia actuator still requires (compulsorily) the application of safety arms on the windows.

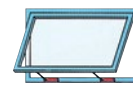
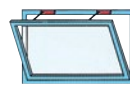



Exclusive quick-fit system securing the operator to the frame.

Apricolor VARIA is an electromechanical chain operator with internal nylon magazine.

It is suitable for bottom-hinged and outward-opening applications, and features an adjustable stroke from 90 to 400 mm.

230 V and 24 V operation.
It can be connected in parallel.
The chain is rust-proof thanks to the Dacro-met coating.

Apricolor VARIA T is designed for twin-mounting on single windows with width over 1600 mm. Apricolor VARIA T stands out for its overload protection, shared between the two parallel-connected operators. If one of the two trips, the other stops its motion, thus protecting the frame from torsional stresses.

ITEM NUMBER	CHAIN OPERATORS	POWER SUPPLY	NOTES	€
43503/021	APRICOLOR VARIA RAL9005 Black	230 Vca	Screw Kit (conventional fitting) included	130,96
43503/022	APRICOLOR VARIA RAL9010 White	230 Vca	Screw Kit (conventional fitting) included	137,92
43503/023	APRICOLOR VARIA RAL9006 Grey	230 Vca	Screw Kit (conventional fitting) included	125,74

ITEM NUMBER	CHAIN OPERATOR PARALLEL CONNECTION ON THE SAME FRAME	POWER SUPPLY	NOTES	€
43503/024	APRICOLOR VARIA T RAL9005 Black (for installation with another Varia T, >1,600 mm-wide windows)	230 Vca	Screw Kit (conventional fitting) included	144,87
43503/025	APRICOLOR VARIA T RAL9010 White (for installation with another Varia T, >1,600 mm-wide windows)	230 Vca	Screw Kit (conventional fitting) included	152,41
43503/026	APRICOLOR VARIA T RAL9006 Grey (for installation with another Varia T, >1,600 mm-wide windows)	230 Vca	Screw Kit (conventional fitting) included	144,87

ITEM NUMBER	CHAIN OPERATORS	POWER SUPPLY	NOTES	€
43502/001 *	APRICOLOR VARIA RAL9005 Black	24 Vcc	Screw Kit (conventional fitting) included	129,23
43502/002 *	APRICOLOR VARIA RAL9010 White	24 Vcc	Screw Kit (conventional fitting) included	140,25
43502/003 *	APRICOLOR VARIA RAL9006 Grey	24 Vcc	Screw Kit (conventional fitting) included	129,23

ITEM NUMBER	DESCRIPTION	NOTES	€
43501/050	Extension Pin for chain connection - 38mm	For wood/PVC frames Minimum pack 10 pcs	4,05
43503/055 *	SCREW KIT conventional fitting system for outward- opening windows	Minimum pack 10 pcs	6,36
43503/056 *	SCREW KIT conventional fitting system for bottom-hinged windows	Minimum pack 10 pcs	6,36

* Until stocks last

NOTE: for motor control unit selection, please refer to the "Home automation" chapter.

NOTE: All prices are subject to variation.

ST 450N
Stroke 180ST 450N
Stroke 300

ST 450N

i223

Arm operator for domes, vertical sun blinds, jalousie windows, outward-opening windows.

TECHNICAL DATA

POWER SUPPLY	230 Vca - 50 Hz
ABSORBED POWER	150 W
ABSORBED CURRENT	0,70 A
MAX. THRUST AND TRACTION FORCE	450 N
MAX. STROKES	mm 180 - 300
AUTOMATIC LIMIT STOP	YES
PARALLEL CONNECTION	YES
OVERLOAD PROTECTION	YES, with 1 motor for each frame
CAPACITOR	1 per 5 μ F
BUILT-IN RELAY	YES
PROTECTION DEGREE	IP55 (indoor use)
OPERATOR WEIGHT	2.0 Kg





Innovative magnetic limit stop detection system without moving mechanical parts: it further increases product reliability in any working condition.

Product dimensions are designed to be as compact as possible to ensure an installation that blends with the rest of the building.

Silent operation and speed are the two strengths of the ST 450N operator.

Can be connected in parallel thanks to the relay built into the card.

Electronic operator in aluminium casing with straight-arm linear movement.

230 Vac power supply with overload protection. Max. stroke 300 mm. Available accessory: Kit for limit stop adjustment. Features a reed switch system without moving mechanical parts. Brackets and supports are supplied for the required application.

ITEM NUMBER	DESCRIPTION	STROKE mm	POWER SUPPLY	€
43545/011	ST 450 N With fixing accessories for OUTWARD-OPENING applications 180	180	230 Vca	136,18
43545/012	ST 450 N With fixing accessories for OUTWARD-OPENING applications 300	300	230 Vca	136,18
43545/013	ST 450 N With fixing accessories for jalousie windows and vertical sun blinds	180	230 Vca	177,92

43545/050	ST 450 N stroke adjustment KIT			19,12
-----------	--------------------------------	--	--	-------

NOTE: For motor control unit selection, please refer to the "Home automation" chapter.

NOTE: All prices are subject to variation.



ST450N model for jalousie windows and vertical sun blinds.

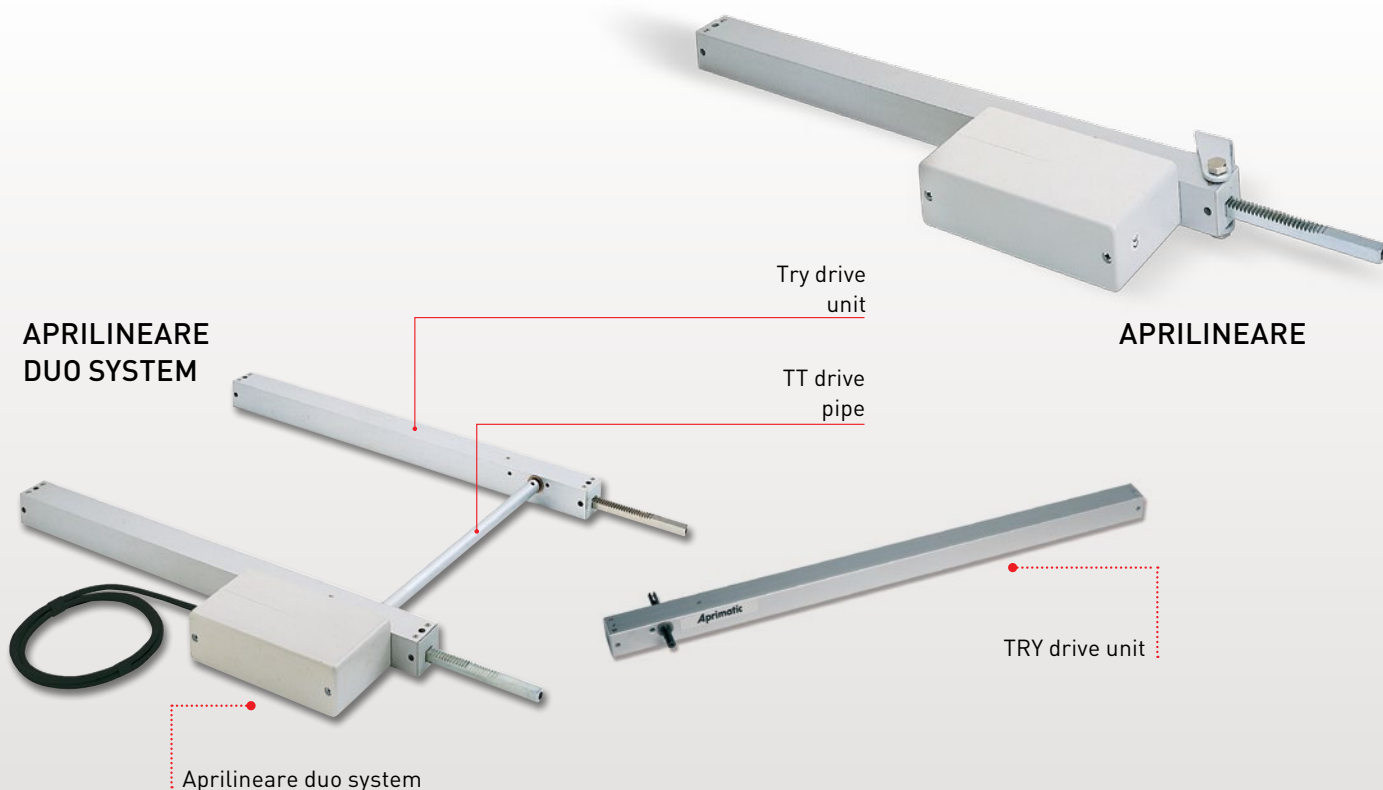

APRILINEARE - DUO SYSTEM

i224

Rack operators (with two or three thrust points) for bottom-hinged and outward-opening applications, shed, skylights, domes, vertical sun blinds and sliding windows.

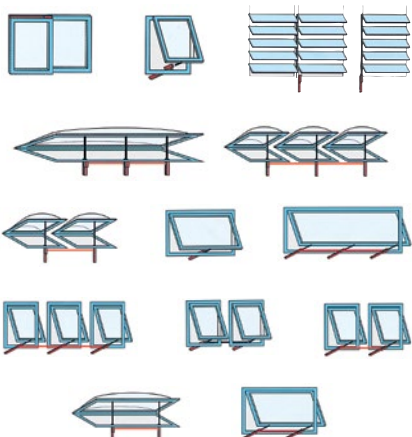

TECHNICAL DATA	APRILINEARE	DUO SYSTEM
POWER SUPPLY	230 Vca - 50 Hz	230 Vca - 50 Hz 24 Vcc - 50 Hz
ABSORBED POWER	20 W	20 W
ABSORBED POWER	0,1A	0,1A (230 V) 0,8A (24 V)
THRUST AND TRACTION FORCE	650 N	600 N (duo-try system)
SHIFTING SPEED	30 mm/s	8 mm/s
STANDARD AVAILABLE STROKES	170, 230 mm	350, 550, 750 mm
LIMIT SWITCH	Electronic	Electronic
STANDARD LENGTH DRIVE PIPES		844, 1244, 1544, 1844, 1944 mm
STANDARD LENGTH DRIVE PIPES		900, 1300, 1600, 1900, 2000 mm
COLOURS	Silver	Silver
PARALLEL CONNECTION	YES	YES, with 1 moto for each frame
OPERATING TEMPERATURE	-5° +40° C	-5° +40° C
PROTECTION DEGREE	IP55	IP55



Aprilineare serie are windows operators for vertical sunblinds, domes or applications that required on the frame one thrust point.

Duo System and Try System are ideal for use with automation systems for large domes, outward-opening windows and large skylights. They are valid alternatives in applications requiring two or three thrust points.

Duo and Try system have perfect balance and therefore evenly- distributed movement are obtained, even with large frames, by exploiting **the power and reliability** of a motor unit combined with one or two more thrust units.

Electric anodised aluminium operators with rack-driven linear movement, fitted with an electronic limit stop, IP55 protection degree, anodised aluminium bracket and galvanised steel frame mount. The operators can be connected in parallel.

The rack is made of C43 galvanised steel, and has a 10 x 10 square section. The box is made of two pieces of sealed impact-proof ABS. The operators are fitted with an internal cable.

The motor Duo System Can be used in conjunction with the TRY drive units made of anodised aluminium and consisting of: a C43 galvanised steel rack with 10 x 10 square section complete with anodised aluminium bracket and galvanised steel frame mount. The drive pipes for connection to two or three thrust points are made of anodised aluminium and are supplied complete with fixing screws.



ITEM NUMBER	DESCRIPTION OF APRILINEARE FOR VERTICAL SUN BLINDS	STROKE mm	POWER SUPPLY	€
43571/001	APRI 17 230 Stainless steel Aprilineare (version with 650N thrust force)	170	230 Vca	202,27
43571/002	APRI 23 230 Stainless steel Aprilineare (version with 650N thrust force)	230	230 Vca	201,11

ITEM NUMBER	230V RACK OPERATORS	STROKE mm	POWER SUPPLY	€
43572/001	APRI DUO 35	350	230 Vca	204,59
43572/002	APRI DUO 55	550	230 Vca	210,38
43572/003	APRI DUO 75	750	230 Vca	221,39

ITEM NUMBER	24V RACK OPERATORS	STROKE mm	POWER SUPPLY	€
43573/001	APRI DUO 35	350	24 Vcc	172,12
43573/002	APRI DUO 55	550	24 Vcc	177,92
43573/003	APRI DUO 75	750	24 Vcc	190,10

ITEM NUMBER	DRIVE UNITS	STROKE mm	NOTES	€
43574/050	TRY 35 drive unit	350	For use with ApriDuo + 2TT or 1TT	83,30
43574/051	TRY 55 drive unit	550	For use with ApriDuo + 2TT or 1TT	90,40
43574/052	TRY 75 drive unit	750	For use with ApriDuo + 2TT or 1TT	99,86

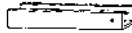
ITEM NUMBER	DRIVE PIPES	NOTES	€
43531/050	TT 90 (centre distance 900 mm)	Pipe length = rack centre distance -56 mm	23,17
43531/051	TT 130 (centre distance 1300 mm)	Pipe length = rack centre distance -56 mm	26,65
43531/052	TT 160 (centre distance 1600 mm)	Pipe length = rack centre distance -56 mm	27,81
43531/053	TT 190 (centre distance 1900 mm)	Pipe length = rack centre distance -56 mm	30,13
43531/054	TT 200 (centre distance 2000 mm)	Pipe length = rack centre distance -56 mm	31,29

ITEM NUMBER	DESCRIPTION		€
43580/064	Support bracket in silver anodised aluminium for special outward-opening applications		7,57
43580/065	350 mm rear bracket for domes, in silver anodised aluminium for fixing to the rear mount of the operator		29,11
43580/067	Second bracket for sliding windows in silver anodised aluminium.		6,55
43580/068	Adjustable "CK" support in galvanised sheet metal		23,28

NOTE: for motor control unit selection, please refer to the "Home automation" chapter.

NOTE: All prices are subject to variation.

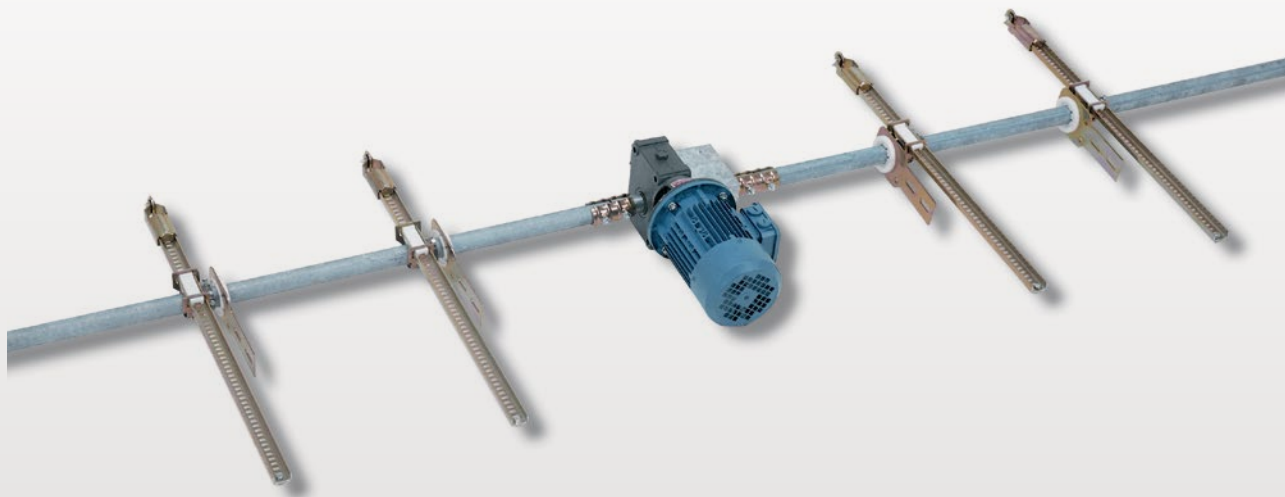

520/600RF - 520/700RF

i225

Systems for remote automation of windows.

ELEMENTS OF THE SYSTEM:

- 1 - Gear motor unit
- 2 - Limit stop device
- 3 - Rotary shaft
- 4 - Shaft support bracket
- 5 - Rack rail
- 6 - Frame mount with spring compensator

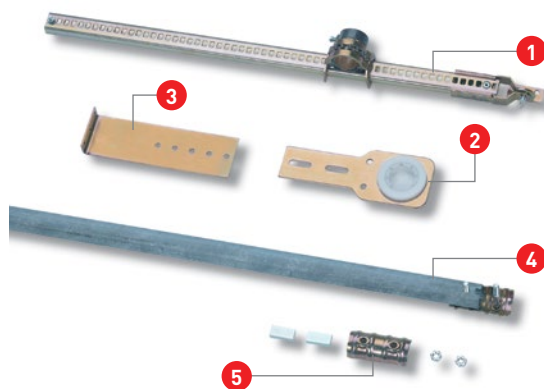
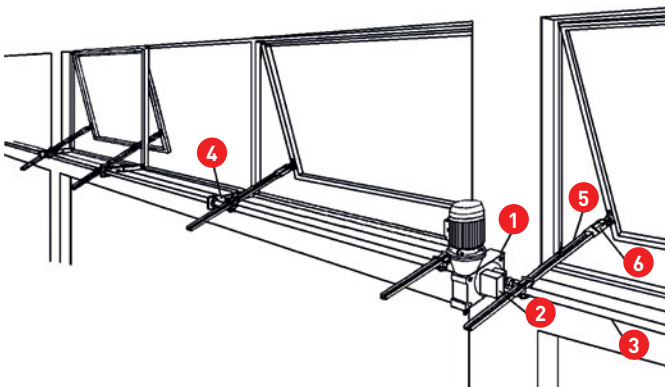

- 1 - Rack rail for bottom-hinged or outward-opening applications:
 - Spring compensator (pull or push)
 - Sprocket for rotary shaft (\varnothing 27-33-42 mm)
- 2 - Standard bracket running on ball bearings for rotary shaft support (\varnothing 27-33-42 mm)
- 3 - Counter-bracket (length 140-210 mm)
- 4 - Galvanised rotary shaft (\varnothing 27-33-42 mm)
- 5 - Joint with coupling pin for rotary shaft (\varnothing 27-33-42 mm).



The new 520/600RF and 520/700RF systems have been designed to solve the problems represented by remotely opening and closing bottom-hinged or outward-opening windows, whether installed individually or in rows, also in long rows of windows, skylights, in breeding farms or greenhouses.

The windows are opened and closed by a series of rack rails running on a toothed sprocket, driven by a shaft, which in turn is turned by a gear unit.

The transmission of the rotational movement from the gear unit to the shaft, and from each element to the next on the shaft is guaranteed by joints with bolts and coupling pin.

The spring compensator on the end of the rack may be of the pulling or pushing type depending on which way the windows close, and guarantees even pressure on the window frames.

The rotary shaft **support brackets** run on ball bearings and have adjustment slots. They can also be fitted with counter-brackets. Available for shafts with diameters of 27-33-42 mm.

The rack rails feature brass toothed sprockets, which must be fixed to the rotary shaft using the relevant press-fit bolts.

The bracket, to screw onto the window, is held on the rack with a practical spring-loaded pin.



520/600RF Motor



520/700RF Motor

APRICOP MOTOR

Electrical gear unit with single-phase motor coupled to a self-locking worm screw gear unit.
With limit stop.

520 SERIES MOTORS

The 520 series motors have a three-phase motor coupled to a steel self-locking worm screw gear unit with bronze machined-from-solid gears in a cast iron self-lubricated casing.

The low-speed shaft has two protuberances with holes and a slot on both ends, so that it can be positioned in the centre or at one end of the gear unit.

The rotary limit stops are fast-acting and adjustable, and are fitted on one of the two hubs of the low-speed shaft, with an aluminium protective cover.

MOTOR UNIT TECHNICAL SPECIFICATIONS

SERIES	MOTOR					ADJUSTABLE REV NO ON LIMIT STOP		MAX. THRUST RACKS N	FRONT LENGTH m	PROTECTION DEGREE IP	
	Rf= WITH ROTARY LIMIT STOP	Kw (CV)	POLES (Size)	VOLTAGE	SHAFT Ø mm	TORQUE N (GIRI 1')	Min				Max
APRICOP		0,52	4 (0,70)	Single-phase	33	5	1 (15)	12	1200	25	30
520/600RF		0,18 (0,25)	6 (63)	Three-phase	33	115 (5,8)	1	11	4200	50	55
520/600RF		0,18 (0,25)	6 (63)	Three-phase	42	115 (5,8)	1	11	3000	50	55
520/700RF		0,37 (0,5)	6 (71)	Three-phase	33	250 (7)	1	11	11760	100	55
520/700RF		0,37 (0,5)	6 (71)	Three-phase	42	250 (7)	1	11	9400	120	55



520/600RF - 520/700RF

i 236

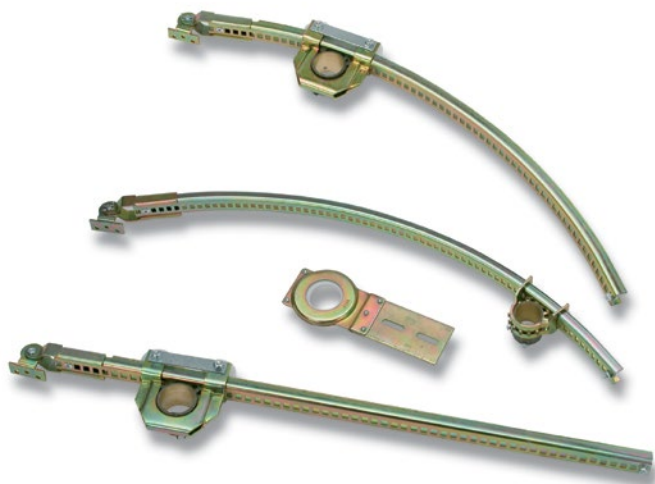

RACK RAILS

A curved rack can be supplied, in order to reduce the inward projection in the presence of obstacles or in case of window frames with limited height from the ground.

TECHNICAL SPECIFICATIONS OF RACKS AND BRACKETS

COMPENSATOR		Sprocket Ø mm	RACK ROD			BRACKET	
Pull on closing	Push on closing		Section mm		Length mm	Load kg	Load kg*
Mod. 377	Mod. 387	27	30 x 14		800 / 1200	40	50
Mod. 379	Mod. 389	33	30 x 14		800 / 1200	50	50
Mod. 380	Mod. 390	42	30 x 18		1000 / 1200	70	60

* Maximum overall load at 18° C.

N.B.: The number of racks to fit on each window must be calculated by taking into consideration the necessary thrust and the dimensions and stiffness of the frame itself.

N.B.: Racks with different lengths are available on demand.

THRUST NEEDED FOR WINDOW OPERATION

OUTWARD-OPENING	PIVOT-HINGED	BOTTOM-HINGED
From 1/3 to 1/2 window weight	About 1/4 window weight	From 1/3 to 1/2 window weight



ITEM NUMBER	DESCRIPTION	€
43550/001	APRICOP single-phase motor (*) Ø 33 mm with limit stop	296,45
43550/051	(*) To be used with adapter for round Apricop pipe	36,35
43562/002	Three-phase Ø 33 mm 520/600RF motor (with limit stop)	986,07
43562/006	Three-phase Ø 42 mm 520/600RF motor (with limit stop)	984,90
43562/004	Three-phase Ø 33 mm 520/700RF motor (with limit stop)	1137,48
43562/008	Three-phase Ø 42 mm 520/700RF motor (with limit stop)	1137,48

RF: with rotary limit stop

NOTE: For applications with over 20m of windows, the unit must be installed in the centre or off-centre, to limit the elastic deformation of the shaft.

ITEM NUMBER	APPLICATION ON OUTWARD-OPENING OR PIVOT-HINGED WINDOWS (pull compensator racks)	€
43563/001	Straight version Mod. 377 - Rack Ø 27 mm - L = 800 mm	29,11
43563/002	Straight version Mod. 377 - Rack Ø 27 mm - L = 1,000 mm	30,28
43563/003	Straight version Mod. 377 - Rack Ø 27 mm - L = 1,200 mm	31,44
43563/021	Curved version Mod. 377 - Rack Ø 27 mm - L = 800 mm	30,28
43563/006	Straight version Mod. 379 - Rack Ø 33 mm - L = 1,000 mm	26,78
43563/007	Straight version Mod. 379 - Rack Ø 33 mm - L = 1,200 mm	29,11
43563/008	Straight version Mod. 379 - Rack Ø 33 mm - L = 1,400 mm	29,11
43563/026	Curved version Mod. 379 - Rack Ø 33 mm - L = 1,000 mm	27,95
43563/010	Straight version Mod. 380 - Rack Ø 42 mm - L = 1,000 mm	52,98
43563/011	Straight version Mod. 380 - Rack Ø 42 mm - L = 1,200 mm	54,15
43563/012	Straight version Mod. 380 - Rack Ø 42 mm - L = 1,400 mm	55,32
43563/030	Curved version Mod. 380 - Rack Ø 42 mm - L = 1,000 mm	54,15
43562/052	Complementary coupling, pin and rack spring package	5,46

ITEM NUMBER	APPLICATION ON BOTTOM-HINGED WINDOWS (push compensator racks)	€
43564/001	Straight version Mod. 387 - Rack Ø 27 mm - L = 800 mm	30,28
43564/002	Straight version Mod. 387 - Rack Ø 27 mm - L = 1,000 mm	31,44
43564/003	Straight version Mod. 387 - Rack Ø 27 mm - L = 1,200 mm	32,61
43564/021	Curved version Mod. 387 - Rack Ø 27 mm - L = 800 mm	31,44
43564/006	Straight version Mod. 389 - Rack Ø 33 mm - L = 1,000 mm	26,78
43564/007	Straight version Mod. 389 - Rack Ø 33 mm - L = 1,200 mm	27,95
43564/008	Versione dritta Mod. 389 Cremagliera Ø 33 mm - L = 1400 mm	29,11
43564/026	Curved version Mod. 389 - Rack Ø 33 mm - L = 1,000 mm	27,95
43564/010	Straight version Mod. 390 - Rack Ø 42 mm - L = 1,000 mm	52,98
43564/011	Straight version Mod. 390 - Rack Ø 42 mm - L = 1,200 mm	54,15
43564/012	Straight version Mod. 390 - Rack Ø 42 mm - L = 1,400 mm	55,32
43564/030	Curved version Mod. 390 - Rack Ø 42 mm - L = 1,000 mm	54,15
43562/052	Complementary coupling, pin and rack spring package	5,46

NOTE: A complementary coupling, pin and rack spring package must be ordered for each rack, Item No. 43562/052. (min.quantity 20pcs)

NOTE: Always indicate the radius required for curved racks (minimum radius 750 mm).

Oversized racks are available on request (max. length 2,200 mm). When ordering, indicate the item number corresponding to the first larger standard-length rack and indicate the exact measurement in millimetres.

Delivery - 5 weeks from date of order. Contact customer service for AN estimate and availability.

ITEM NUMBER	DESCRIPTION OF ACCESSORIES FOR RACK SYSTEM	€
43562/055	Standard bracket for Ø 27 mm	9,64
43562/054	Standard bracket for Ø 33 mm	9,64
43562/057	Standard bracket for Ø 42 mm	13,38
43562/058	Counter-bracket L = 140 mm	4,87
43562/059	Counter-bracket L = 210 mm	6,04

ITEM NUMBER	DESCRIPTION OF PIPE ACCESSORIES	€
43562/062	Steel joint for Ø 33 mm shaft	4,87
43562/061	Steel joint for Ø 42 mm shaft	6,04
43562/060	Key for Ø 33 mm shaft	3,82
43562/063	Key for Ø 42 mm shaft	3,83

NOTE: All prices are subject to variation.



04.

SLIDING DOORS

SLIM SNK
WING NK
WING NK H150
MODULAR SOLUTION
DOOR PROFILES
OVER

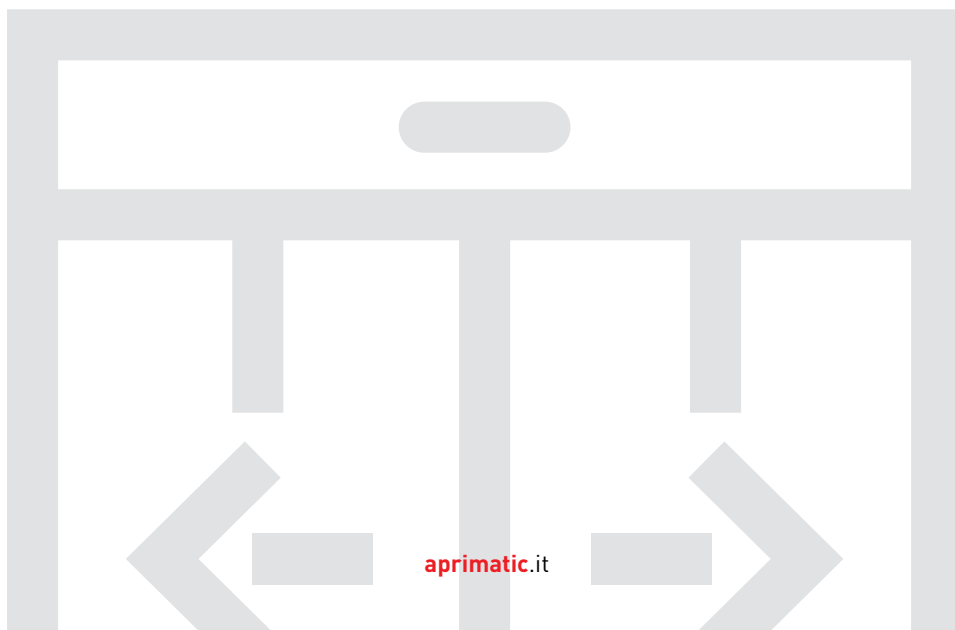

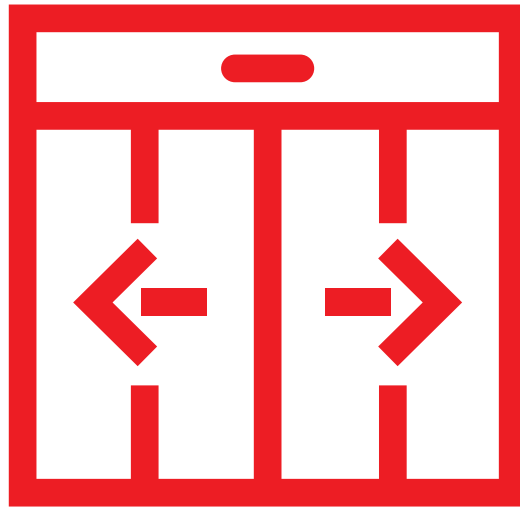



AUTOMATION SYSTEMS FOR SLIDING DOORS

**WING NK / WING NK H150 / SLIM SNK****Smooth, accurate, silent movement.**

Aprimatic offers a wide range of automation solutions for sliding doors. Products designed to provide top reliability in a wide range of applications for offices, shops and supermarkets.

All automation components feature compact, attractively designed extruded aluminium housings. The units are easy to install and do not require specialised skills or masonry work.

The automation units are equipped with intelligent electronic control systems which require very few adjustments. This makes for quicker installation and easier maintenance operations, while guaranteeing total safety.

Drive system with a toothed HPPD rubber drive belt. The belt is reinforced with a glass fibre core and has a non-slip coating. Modular carriages with large-diameter reinforced-nylon wheels running on upper and lower semicircular cross-section rails. The carriage modules feature an anti-derailment, anti-pitching, load-balancing system. Reversible DC Gear motor with electronic pulse width control. 2-channel optical encoder connected

to the motor for electronic position and speed control. The control units ensure the highest levels of safety and reliability. Performance features include: stroke length, wing weight, braking force and braking distance self-learning. They also guarantee the emergency battery charge. Compact and aesthetically pleasing aluminium profile covers, available in natural, anodised silver and anodised black versions.

Wing NK

Reversible single-motor automation for sliding doors. Suitable for shops, supermarkets and offices with high traffic levels. Designed for medium-heavy loads.

Max. load for heavy-duty use (4 cycles/min.):
For 2 wings, 100 kg each for one wing 150 kg.
Max. load for continuous use (6 cycles/min.):
For 2 wings, 80 kg each for one wing 130 kg.

Wing NK H150

New reversible single-motor automation for sliding doors. Suitable for shops, supermarkets and offices with high traffic levels. Designed for medium-heavy loads.

Max. load for heavy-duty use (4 cycles/min.):
For 2 wings, 150 kg each for one wing 150 kg.
Max. load for continuous use (6 cycles/min.):
For 2 wings, 130 kg each for one wing 150 kg.

Slim SNK

Reversible single-motor automation for sliding doors. Suitable for shops, supermarkets and offices with medium traffic levels and medium-light loads.

Max. load for NON intensive use (<3 cycles/min.):
For 2 wings 70 kg each, for one wing 100 kg.
Max. load for heavy-duty use (4 cycles/min.):
For 2 wings, 50 kg each for one wing 70 kg.



AUTOMATION SYSTEMS FOR SLIDING DOORS



05. Home automation

04. Sliding doors

03. Windows and domes

02. Side-hung shutters

01. Rolling shutters



TECHNICAL DATA

WING NK 1 WING NK 2

WING NK H150 1 WING NK H150 2

SLIM SNK 1 SLIM SNK 2

GENERAL FEATURES			
AUTOMATION POWER SUPPLY	Single-phase 230 Vac (+/- 10%) – 50 Hz		
MOTOR POWER SUPPLY	24 Vdc with high performance toroidal transformer		
ACCESSORY POWER SUPPLY	24 Vdc/Vac	24 Vdc/Vac	24 Vdc/Vac
OPERATING TEMPERATURE RANGE	-20°+60° C	-20°+60° C	-10°+60° C
INSTALLED POWER (MAX.)	300 W	300 W	130 W
DIMENSIONS in mm			
BULK (HxD) mm	152x172	152x172	152x172
MIN./MAX. BEAM LENGTH mm	1,810-6,010	1,810-6,010	1,810-5,410
MIN./MAX. PASSAGE SPAN mm	850-2,950	850-2,950	850-2,650
WING LOAD CAPACITY in kg			
MAX. LOAD	100x1 100x2	150x1 150x2	100x1 70x2
SPEED in cm/s			
MIN./MAX. OPENING SPEED	11-75 (1 wing) 22-150 (2 wings)	11-75 (1 wing) 22-150 (2 wings)	40-60 80-120
MIN./MAX. CLOSING SPEED	11-75 (1 wing) 22-150 (2 wings)	11-75 (1 wing) 22-150 (2 wings)	11-50 22-100
APPROACHING SPEED	6	6	6
DRIVE TRANSMISSION			
TRANSMISSION	Toothed HPPD belt		
CARRIAGE TYPE	Modular, 3-wheel carriages (2 for each wing)		
ROLLING TYPE	On reinforced-nylon wheels		



AUTOMATION SYSTEMS FOR SLIDING DOORS

TECHNICAL DATA	WING NK 1 WING NK 2	WING NK H150 1 WING NK H150 2	SLIM SNK 1 SLIM SNK 2
----------------	------------------------	----------------------------------	--------------------------

SELF-LEARNING FUNCTIONS (at power on or after a reset)

OPENING STROKE LENGTH	YES	YES	YES
CLOSING STROKE LENGTH	YES	YES	YES
WING WEIGHT	YES	YES	YES
BRAKING SPACES (adaptive)	YES	YES	YES
OPENING SPEED	YES	YES	YES
CLOSING SPEED	YES	YES	YES

STANDARD FUNCTIONS (selected from key-operated switch or keypad)

NIGHT LOCK	YES	YES	YES
AUTOMATIC TWO-WAY	YES	YES	YES
AUTOMATIC EXIT ONLY	YES	YES	YES
AUTOMATIC ENTRY ONLY	YES	YES	YES
COMPLETELY OPEN	YES	YES	YES
AUTOMATIC PARTIAL OPENING	YES	YES	YES
MANUAL OPENING	~	~	~
NIGHT SERVICE OPENING	~	~	~
RESET	YES	YES	YES

EMERGENCY FUNCTIONS

INPUT FOR EMERGENCY PUSH-BUTTON	YES	YES	YES
ELECTRIC EMERGENCY OPENING DEVICE WITH BATTERY	YES	YES	YES
EMERGENCY OPERATION WITH BATTERY	YES	YES	YES
STOP INPUT	YES	YES	YES

SAFETY FUNCTIONS

INPUT FOR SAFETY PHOTOCELL	YES	YES	YES
OBSTACLE DETECTION (adaptive)	YES	YES	YES

ADJUSTABLE PARAMETERS

OPENING SPEED	YES	YES	YES
CLOSING SPEED	65% opening speed (dipswitch)	YES	YES
APPROACHING SPEED	YES	YES	YES
OPEN PAUSE TIME	YES	YES	YES
THRUST FORCE	YES	YES	YES
ELECTRIC LOCK ACTUATION DELAY	YES	YES	YES
PARTIAL OPENING PERCENTAGE	YES	YES	YES

DIAGNOSTICS

IDENTIFICATION OF DIFFERENT ALARMS AND WARNINGS	YES	YES	YES
--	-----	-----	-----

ADDITIONAL FUNCTIONS (OPTIONAL)

BISTABLE ELECTRIC LOCK WITH SELF-TEST	YES	YES	YES
BUILT-IN EMERGENCY BREAK-OUT OPENING DEVICE	YES	YES	YES
INTERLOCK FUNCTION	YES	YES	YES
MANUAL RELEASE	YES	YES	YES



POSSIBLE CONFIGURATIONS

EXAMPLES OF AUTOMATION SYSTEM CONFIGURATIONS

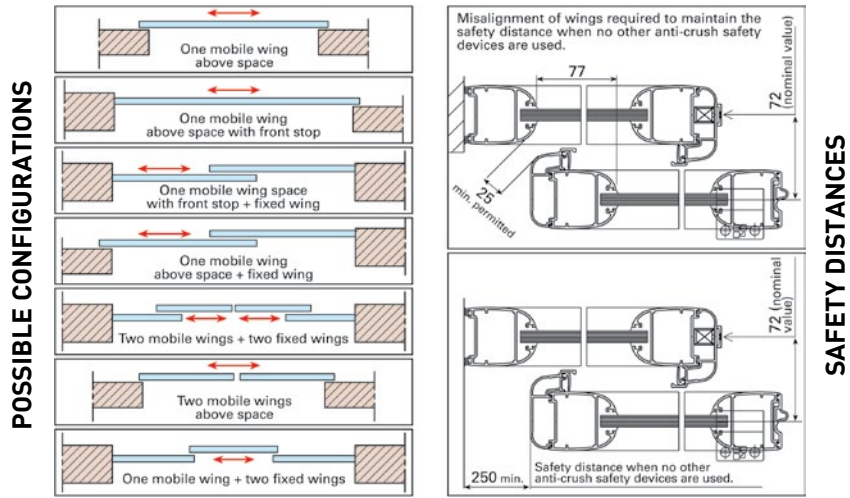

- AUTOMATION + COVER + SC6 + ER6 + NS 48*
- AUTOMATION + COVER + SC6 + ER6 + 1-2 RADAR + NS 48*
- AUTOMATION + COVER + SC6 + ER6 + 1-2 RADAR + NS 48* + EB2
- AUTOMATION + COVER + SC6 + ER6 + 1-2 RADAR + NS 48* + EB2 + SME
- + DCA
- AUTOMATION + COVER + SC6 + ER6 + 1-2 RADAR + NS 48* + EB2
- + RADIO
- + DCA
- AUTOMATION + COVER + SC6 + ER6 + 1-2 RADAR + NS 48* + EB2 + SME
- + RADIO

Key	
AUTOMATION	Choose the model (complete operator assembly or beam system plus module) from the available range: WING NK - WING NK H150 - SLIM SNK
COVER	Choose the cover with the desired surface finish from one of the following: natural, silver, black
SC6	Choose the key-operated selector (REQUIRED): SC6 WIRELESS - SC6 EC - SC6
ER6	Choose the photocells: ER6 UNI - ER6/N
1-2 RADAR	Choose the radar: RI90C, DM-H22, DT90C, RSI 4C
NS 48*	*Batteries supplied as a standard on all models
EB2	Electric lock: EB2
SME	Choose the Emergency Manual Release device: SME/E - SME/I installable only with EB2
DCA	Choose Alternative Control Devices, if necessary: PC12E - PR5 - LB4 - CT4 (see the "Electronic devices" section - refer to the initial index)
RADIO	Choose the remote control and receiver: TM4; PLUS SC6 WIRELESS



AUTOMATION SYSTEMS FOR SLIDING DOORS

EX. OF AUTOMATION SYSTEM DIMENSIONING

Two-wing automation system:
Wing NK, Wing NK H150

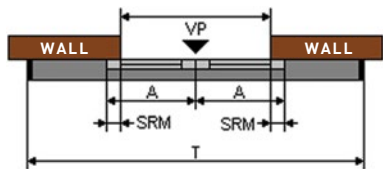

RH single-wing automation system:
Wing NK, Wing NK H150

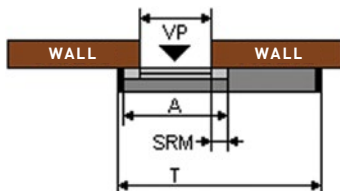

LH single-wing automation system:
Wing NK, Wing NK H150

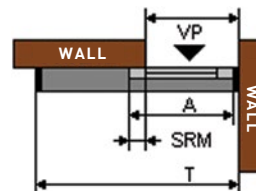

	Known A	Known VP	Known T
T	$4A-2S+10$	$2VP+2S+10$	~
VP	$2(A-S)$	~	$(T-2S-10)/2$
A	~	$(VP+2S)/2$	$(T+2S-10)/4$

	Known A	Known VP	Known T
T	$2A-2S+10$	$2VP+2S+10$	~
VP	$A-2S$	~	$(T-2S-10)/2$
A	~	$VP+2S$	$(T+2S-10)/2$

	Known A	Known VP	Known T
T	$2A-S+10$	$2VP+S+10$	~
VP	$A-S$	~	$(T-S-10)/2$
A	~	$VP+2S$	$(T+S-10)/2$

A = wing length in mm

VP = passage span in mm

T = beam length in mm

S = overlap in mm

NOTE: S - The overlap (S) used in the formula = 50 mm (not binding).

The calculations for RH and LH single-wing automation systems are valid for both opening directions.

For RH single-wing automation, the actual passage span (VP) of the automation is reduced by the size of the overlap selected.

WING NK automation systems with anodised silver finish

Beam	Passage span	LH single wing		RH single wing		Double wing	
		€	42710/201.1	€	42710/201.0	€	42710/201.2
2010	950	2.091,19	42710/201.1	2.091,19	42710/201.0	2.203,04	42710/201.2
2510	1200	2.145,67	42710/251.1	2.145,67	42710/251.0	2.262,76	42710/251.2
3010	1450	2.211,74	42710/301.1	2.211,74	42710/301.0	2.331,14	42710/301.2
3610	1750	2.291,74	42710/361.1	2.291,74	42710/361.0	2.412,29	42710/361.2
4010	1950	2.345,04	42710/401.1	2.345,04	42710/401.0	2.464,45	42710/401.2
4410	2150	2.396,64	42710/441.1	2.396,64	42710/441.0	2.517,19	42710/441.2
4810	2350	2.451,70	42710/481.1	2.451,70	42710/481.0	2.569,94	42710/481.2
5410	2650	2.529,37	42710/541.1	2.529,37	42710/541.0	2.648,76	42710/541.2
6010	2950	2.610,52	42710/601.1	2.610,52	42710/601.0	2.729,91	42710/601.2

Order the automation with the next standard length up from the one you require and then state the exact beam length you require in mm ending with 0 or 5. The standard supply includes the emergency battery unit.

WING NK H150 automation systems with anodised silver finish

Beam	Passage span	LH single wing		RH single wing		Double wing	
		€	42715/201.1	€	42715/201.0	€	42715/201.2
2010	950	2421,56	42715/201.1	2421,56	42715/201.0	2539,80	42715/201.2
2510	1200	2488,80	42715/251.1	2488,80	42715/251.0	2606,44	42715/251.2
3010	1450	2553,12	42715/301.1	2553,12	42715/301.0	2673,68	42715/301.2
3610	1750	2633,11	42715/361.1	2633,11	42715/361.0	2752,51	42715/361.2
4010	1950	2686,43	42715/401.1	2686,43	42715/401.0	2805,84	42715/401.2
4410	2150	2736,86	42715/441.1	2736,86	42715/441.0	2858,58	42715/441.2
4810	2350	2793,09	42715/481.1	2793,09	42715/481.0	2900,32	42715/481.2
5410	2650	2871,90	42715/541.1	2871,90	42715/541.0	2977,98	42715/541.2
6010	2950	2953,05	42715/601.1	2953,05	42715/601.0	3070,13	42715/601.2

Order the automation with the next standard length up from the one you require and then state the exact beam length you require in mm ending with 0 or 5. The standard supply includes the emergency battery unit.

NOTA: All prices are subject to variation.



AUTOMATION SYSTEMS FOR SLIDING DOORS

SLIM SNK automation systems with anodised silver finish

Beam	Passage span	LH € single wing		RH € single wing		Double € wing	
2010	950	1684,88	42705/201.1	1684,88	42705/201.0	1800,80	42705/201.2
2510	1200	1748,07	42705/251.1	1748,07	42705/251.0	1866,31	42705/251.2
3010	1450	1822,26	42705/301.1	1822,26	42705/301.0	1934,69	42705/301.2
3610	1750	1894,12	42705/361.1	1894,12	42705/361.0	2014,67	42705/361.2
4010	1950	1947,45	42705/401.1	1947,45	42705/401.0	2065,69	42705/401.2
4410	2150	1999,03	42705/441.1	1999,03	42705/441.0	2119,58	42705/441.2
4810	2350	2052,93	42705/481.1	2052,93	42705/481.0	2173,50	42705/481.2
5410	2650	2132,92	42705/541.1	2132,92	42705/541.0	2251,16	42705/541.2

Order the automation with the next standard length up from the one you require and then state the exact beam length you require in mm ending with 0 or 5. The standard supply includes the emergency battery unit.

Covers for WING NK, WING NK H150, SLIM SNK automation systems

Beam	Natural € finishing		Silver € finishing		Black € finishing	
2000	107,54	42102/200	123,76	42100/200	145,72	42101/200
2500	120,90	42102/250	144,37	42100/250	166,72	42101/250
3000	135,54	42102/300	158,77	42100/300	190,29	42101/300
3600	162,96	42102/360	190,14	42100/360	213,83	42101/360
4000	175,91	42102/400	199,83	42100/400	232,28	42101/400
4400	190,23	42102/440	213,83	42100/440	256,15	42101/440
4800	209,51	42102/480	248,87	42100/480	285,70	42101/480
5400	228,70	42102/540	254,56	42100/540	313,65	42101/540
6000	255,27	42102/600	278,10	42100/600	343,14	42101/600

WING NK - WING NK H150 - SLIM SNK BEAM SECTION

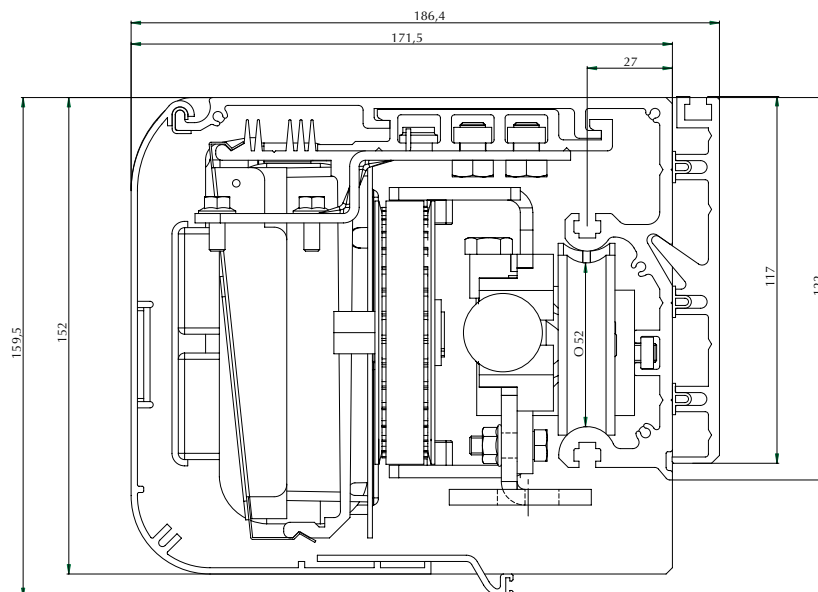

NOTA: All prices are subject to variation.



MODULAR SOLUTIONS

WING NK / SLIM SNK modules

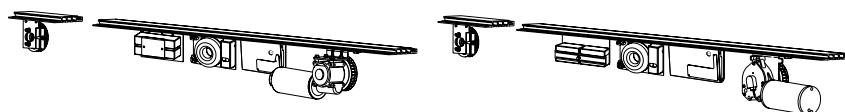

Composition



The WING NK and SLIM SNK modules consists of a module profile L=1,100 mm complete with pre-assembled components: control unit, power supply unit, motor with encoder, emergency batteries. The Module pack also includes an idle pulley and two side flanges.

These modules allow to construct any type of "Wing NK", "Wing NK H150" or "SLIM SNK" automation systems with the same technical characteristics and functions as





described above. The NK module profile is supplied ready for installation, complete with the control unit, power supply unit, motor and batteries ready-assembled.

To complete an automation you will need the following: the "L" beam (of convenient length), the hardware kit; the toothed belt and the cover.

MODULE DESCRIPTION

	DESCRIPTION	BEAM		PASSAGE SPAN	
		Min.	Max.	Min.	Max.
	Wing NK Module L=1100 mm	1810	6010	850	2950
	SLIM SNK Module	1810	5410	850	2650

AVAILABLE NK MODULES AND COMPULSORY AND OPTIONAL COMPONENTS

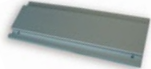
	ITEM NUMBER	DESCRIPTION	€
	42902/003	WING NK module L=1,100 mm	1566,65
	42900/002	SLIM SNK Module	1307,57
	42910/006	L shaped beam* with anodised silver finish L=7,000 mm	73,74 /m
	42000/010	Cover* with natural finish L=7,000 mm	40,19 /m
	42000/001	Cover* with silver finish L=7,000 mm	42,34 /m
	42000/006	Cover* with black finish L=7,000 mm	56,13 /m
	42280/068	Drive belt for modules L=1,100 (in pack of 50mt)	780,17
	42710/100	Drive belt for modules L=1,100 (in pack of 50 m) Toothed belt 7 m / RR	205,18
	Single wing 42902/053	Hardware Kit for SLIM SNK and WING NK modules	136,36
	Double wing 42902/051	The kit consists of all the mechanical components needed to assemble the automation system and includes: carriage units, connection plates, mechanical stop plates and a pack of nuts/bolts/screws	197,58
	Single wing 42902/054	Hardware Kit for WING NK H150 module	203,08
	Double wing 42902/055	The kit consists of all the mechanical components needed to assemble the automation system and includes: carriage units, connection plates, mechanical stop plates and a pack of nuts/bolts/screws	280,92
	42902/056	NK 250 accessory mounting profile, every accessory requires one profile	21,05

* All profiles are supplied in lengths of 7 m which cannot be split.

NOTA: All prices are subject to variation.



MODULAR SOLUTIONS

EX. OF AUTOMATION SYSTEM DIMENSIONING

WING NK - WING NK H 150 MODULE

WING NK / NK H150 module:
RH single-leaf and double-leaf

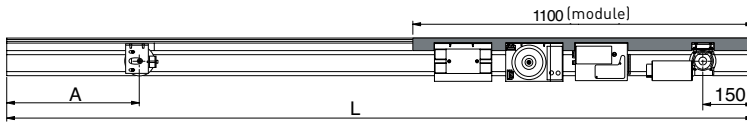

WING NK / NK H150 module:
LH single-wing

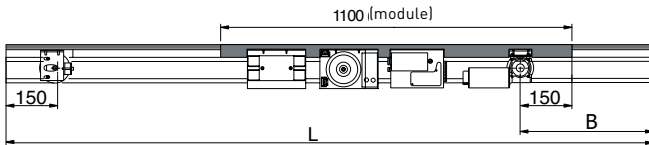

"L" (mm)	"A" (mm)	"B"(mm)
1800	300	300
2000	350	350
2400	450	450
2500	475	475
2800	550	550
3000	600	600
3200	650	650
3600	750	750
4000	850	850
4400	950	950
4800	1050	1050
5400	1200	1200
6000	1350	1350

SLIM SNK MODULE

SLIM SNK module:
RH single-leaf and double-leaf

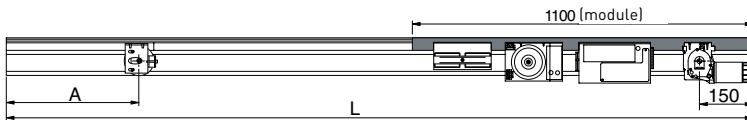

SLIM SNK module:
LH single-wing

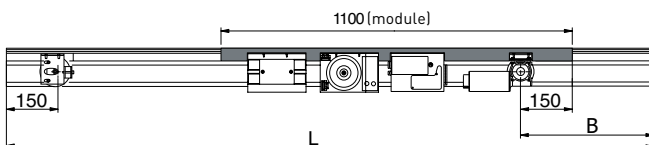

"L" (mm)	"A" (mm)	"B"(mm)
1800	275	300
2000	325	350
2400	425	450
2500	450	475
2800	525	550
3000	575	600
3200	625	650
3600	725	750
4000	825	850
4400	925	950
4800	1025	1050
5400	1175	1200

NOTA: All prices are subject to variation.



KIT UPGRADE WING NK

**Application range:**

The WING NK upgrade kit can only be installed on: **Automatic doors of the WING or WING EVO model** on the catalogue since 2003.

TECHNICAL DATA

AUTOMATION POWER SUPPLY	SINGLE-PHASE 230 Vac (+/- 10%)
MOTOR POWER SUPPLY	24 Vdc
TEMPERATURE	-10° +60° C
BATTERY CHARGER	BUILT-INTO WING NK CARD
AUTOMATIC DIAGNOSTIC	SEVERAL TYPES OF BUZZER ALARMS
ADJUSTABLE PARAMETERS:	APPROACH SPEED DURING OPENING AND CLOSING DOOR OPEN PAUSE TIME THRUST FORCE ELECTRIC LOCK ACTIVATION DELAY PARTIAL OPENING PERCENTAGE MASTER/SLAVE EMERGENCY OPENING PHOTOCELLS USED SETTINGS FOR TAMPERING, EMERGENCY OPENING, ELECTRIC LOCK AND POWER FAILURE

The Upgrade KIT allows all Aprimatic automatic door customers (Wing and Wing Evo series) to replace the basic components to adapt the "old" system to the new performance levels of the new WING NK series automation systems. The mechanical operations required for the replacement are extremely simple (the same bolts and component measurements are used) while the electronic operations are even simpler: just disconnect the old control unit and the peripheral units from the terminals and insert the new card. Once it is powered up, the new Wing NK control board will do all the rest: the new HIGH-TECH software requires no manual operations: it will automatically learn all the necessary settings (such as wing weights, etc.) and self-calibrate as efficiently as possible.

ITEM NUMBER	DESCRIPTION	€
42902/052	WING NK UPGRADE KIT The package includes: Gear motor unit, Wing NK control unit, idle pulley and fixing screws	1061,82

NOTA: All prices are subject to variation.







CONTROL AND SAFETY DEVICES



Stylish and functional design.

The key-operated selector units can be used to set and select 6 operating modes for automatic sliding doors. The SC6EC and SC6 WIRELESS key-operated selector units can be surface wall-mounted or flush-mounted in a standard 503 electrical box.

The Reset push-button on the key-operated selector unit is small and recessed to prevent accidental operation.



CONTROL AND SAFETY DEVICES			
	ITEM NUMBER	DESCRIPTION	€
	42282/078	SC6 WIRELESS - 6-way key-operated selector unit for setting standard functions, it operates by radio waves with a frequency of 433.92 MHz, installation: wall-mounted or flush-mounted with 503 box, PLUS SC6 WIRELESS receiver required	128,55
	42282/073	SC6EC - 6-way key-operated selector unit for standard function setting, installation: wall-mounted or flush-mounted in 503 box, 4-metre cable with connector	118,55
	41923/007	PLUS SC6 WIRELESS RECEIVER - Installation on NK beams requires the NK 250 mm profile, SC6 WIRELESS key-operated selector and/or TR2 or TR4 transmitter required	119,38
	42282/070	SC6 - 6-way key-operated selector unit for standard function setting installation: wall-mounted - 4-metre cable with connector	93,99
	41905/004	TM4 - 433.92 MHz four-channel remote control	38,41

PHOTOCELLS			
	ITEM NUMBER	DESCRIPTION	€
	42300/007	ER6/N - Self-aligning, miniaturised, modulated infrared photocells Range of 6 metres at full power and 3 metres at half power, the unit consists of: amplifier card for two pairs of photocells with self-test function (fault signal relay output) and twin-relay output with series-connected contacts, pair of transmitter/receiver photocells with 8-metre shielded cables, fittings for assembly on aluminium frames, installation on NK beams requires the NK 250 profile	143,96
	42300/002	ER6/N Pre-mounted NK (can be ordered only with the purchase of an automation system)	193,13
	42300/006	Kit of extra ER6/N photocells	42,80

NOTE: By ticking the appropriate box on the order form, the photocells ER6/N item No. 42300/002 will be supplied pre-assembled and pre-mounted on the beam at the same price.

NOTA: All prices are subject to variation.









CONTROL AND SAFETY DEVICES

RADAR

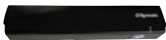
The range encompasses

all the technologies used for automatic door opening devices, such as microwave, active infrared and passive infrared.

RADAR			
	ITEM NUMBER	DESCRIPTION	€
	42282/092	RI-H5 - Medium-range combined door activation and safety sensor with 4 detection rows (active infrared technology)	234,09
	42283/092	RI90C - Radar infrared safe	229,95
	42283/091	DM-H22 - Bi directional door sensor (microwave technology)	185,85
	42283/090	DT90C double technology safe radar	389,68
	42283/096	RSI 4C - Door-wing mounted swing door safety sensor, (active infrared distance measurement technology)	366,45
	42283/098	MS20 Microwave contactless switch (Based S4)	187,95
	42282/097	PBH - Mechanical button for pedestrian doors (dim.115x115x44 mm)	158,60

TECHNICAL DATA	DM-H22	DT90C	RI-H5	RI90C	RS-I4C
TECHNOLOGY	Microwaves	Microwaves Active infrared	Active infrared	Active infrared	Active infrared
INSTALLATION HEIGHT	4 m max.	From 1,8 a 4m max	3 m max	3 m max.	3,5 m max.
DETECTION MODES	Movement and movement	Presence and movement	Presence and movement	Presence	Presence
SUPPLY VOLTAGE	12-30 Vcc +/-10%	12V+/- 5%	12-32 Vca +/-10% 12-32 Vcc +/-10%	12-30 Vca +/-10% 12-30 Vcc +/-10%	12-24 Vca/cc +/-10%
CONSUMPTION	>1W (a 24V)	>3W (a 24V)	1,45 W (a 24 V)	1,45 W (a 24 V)	< 1 W (a 24 V)
TEMPERATURE RANGE	-20°C+55°C	-25°C +55°C	-20°C +60°C	-25°C +55°C	-25°C +55°C
DIMENSIONS (LxDxH)	123 x 57 x 65	260 x 44 x 55	210 x 65 x 30	210 x 65 x 30	300 x 48 x 44
CABLE	YES	YES	YES	YES	YES
EN16005	-	YES		YES	YES

NOTA: All prices are subject to variation.



INSTALLATION ACCESSORIES

EMERGENCY PUSH-BUTTON

The emergency push-button enables door opening whenever necessary. It consists

of a highly-visible, red mushroom-head push-button with a twist-to-release action.

EMERGENCY PUSH-BUTTON

	ITEM NUMBER	DESCRIPTION	€
	42282/082	PE - Red mushroom-head emergency push-button with twist-to-release action	54,23







ELECTRIC LOCK AND MANUAL RELEASE UNITS

The electric lock has been designed specifically for locking mobile wings. It is supplied complete with a diagnostics card. The system is not electrically powered when it is in the open or closed position.

The EB2 electric lock can be fitted (on request) with mechanical release systems which is used to release the lock in the event of an operating fault, a mains power failure or a backup battery failure.

A driven external release is also available. This is mounted inside a recessed, wall-mounted, lockable box to protect against unauthorised operation.

ELECTRIC LOCK and MANUAL RELEASE UNITS

	ITEM NUMBER	DESCRIPTION	€
	42282/076	EB2 - Electric lock for two-handed wings, controlled from by an electronic card, with 0.9 m - 1.5 m - 2.5 m, cables, installed on Nk beams with NK 250 mm profile	184,93
	42282/077	EB2 NK PREM (for Slim SNK, Wing NK, Wing NK H150) (can be ordered only with the purchase of an automation system)	206,59
	42280/084	SME - Mechanical release system for EB2 electric lock, for use in the event of faults or power supply failures	66,71
	42280/085	Box for external release drive complete with cable and shield - 5 m	129,33
	41704/002	CS - Built-in strongbox (with up/down button and electrical brake release)	74,19
	41704/004	CSP - Wall mounted outdoor strongbox	61,43

NOTE: By ticking the appropriate box on the order form, the EB2 electric lock code 42282/077, will be supplied pre-assembled and pre-mounted on the beam at the same price.

NS 48



NS 48			
	ITEM NUMBER	DESCRIPTION	€
	42282/075	NS48 (battery units are pre-assembled on all automation systems). Battery unit with double function (charging and diagnostic functions built into the door control device): 1) Electrical emergency opening device 2) Backup battery (autonomy of 1 hour, half-charged)	131,67

NOTA: All prices are subject to variation.



INSTALLATION ACCESSORIES

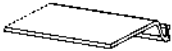
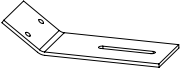
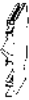

OPTIONAL ACCESSORIES FOR BEAMS AND COVERS

OPTIONAL ACCESSORIES FOR BEAMS AND COVERS			
	ITEM NUMBER	DESCRIPTION	€
	42910/008	Telescopic cover* with natural finish L=7,000 mm	15,14 /m
	42910/010	Telescopic cover* with black finish L=7,000 mm	30,31 /m
	42280/067	Cover fixing bracket, in pack of 10 pcs	46,45
	42910/003	Rear profile* with silver finish L=7,000 mm	50,90 /m
	42280/061	Sound-proofing seal for rear profile (1 m pack)	4,08

* All profiles are supplied in lengths of 7 m which cannot be split.

ACCESSORIES FOR WINGS WITH ALUMINIUM PROFILES

Floor guides for mobile wings.

ACCESSORIES FOR WINGS WITH ALUMINIUM PROFILES			
	ITEM NUMBER	DESCRIPTION	€
	42200/050	SPS - Floor guide set for wing with Small profile frame (Can be used with other types of aluminium profile)	17,02
	42201/051	SPT - Floor guide set for wing with Modular profile frame (Can be used with other types of aluminium profile)	12,08





NOTA: All prices are subject to variation.



INSTALLATION ACCESSORIES

ACCESSORIES FOR GLASS WINGS

Details used exclusively for assembly of mobile glass-only wings (not framed with aluminium profiles).
The new system cuts assembly work to the minimum and facilitates working with glass panels.

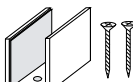
ACCESSORIES FOR GLASS WINGS		ITEM NUMBER	DESCRIPTION	€
	42281/061	PCR - Clamps for glass doors, 3 m raw profile, For 10 mm tempered glass, max. weight 80 kg and max. wing width 1,500 mm	252,82	
	42281/062	Set of fixing accessories for glass wings	112,07	
	42281/063	Additional reinforcement bracket (no. 1 pc) 1 pcs for wing length 900/1200 mm 2 pcs for wing length 1200/1900 mm	20,63	
	42281/064	Plug for glass door clamp (no. 1 pc)	13,97	
	42280/079	GTC - Floor guide set for glass wings	7,60	

UNIVERSAL ACCESSORIES FOR OTHER TYPES OF WINGS

Useful accessories for rapidly fixing new or existing mobile wings to the carriages of APRIMATIC automatic doors.

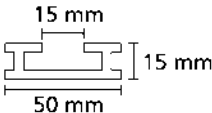
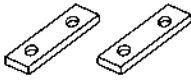
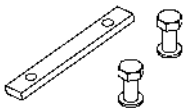
ACCESSORIES FOR WINGS WITH ALUMINIUM PROFILES		ITEM NUMBER	DESCRIPTION	€
	42280/077	PDA - Aluminium adapter profile (L=1500 mm) for one wing, for joining the carriages to the framed wing, connection plates required.	36,28	
	42280/071	CPA - Set of 2 connection plates for one wing, with fixing screws	9,52	
	42200/052	Set of fixing screws for a small wing, contains all necessary screws and fittings to fix the door wing to the automation system carriage	8,30	

NOTA: All prices are subject to variation.



SLIDING OPENINGS

EXAMPLES OF POSSIBLE CONFIGURATIONS

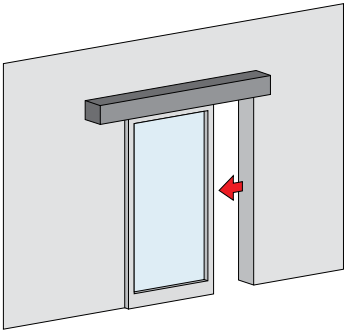

ONE SLIDING WING

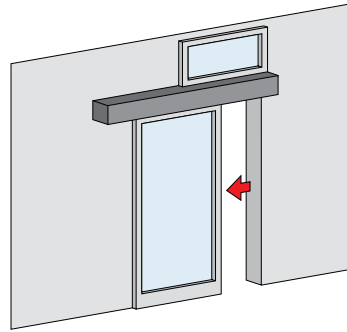

ONE SLIDING WING WITH TRANSOM

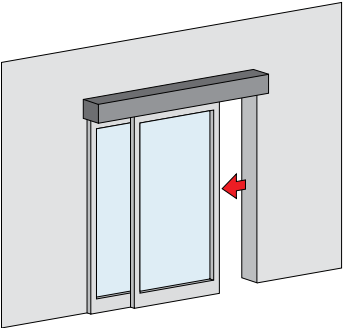

TWO WINGS
ONE SLIDING AND ONE FIXED

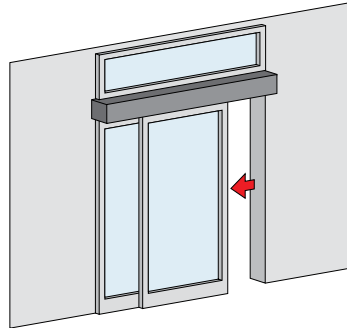

TWO WINGS
ONE SLIDING AND ONE FIXED WITH TRANSOM

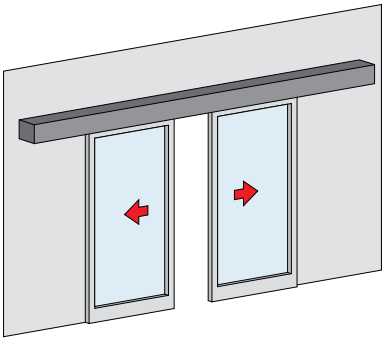

TWO SLIDING WINGS

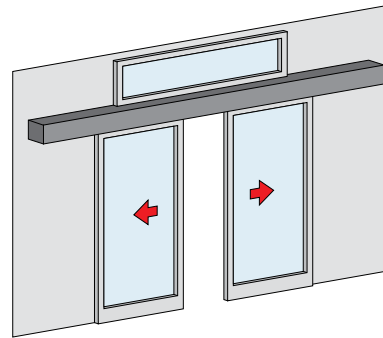

TWO SLIDING WINGS WITH TRANSOM

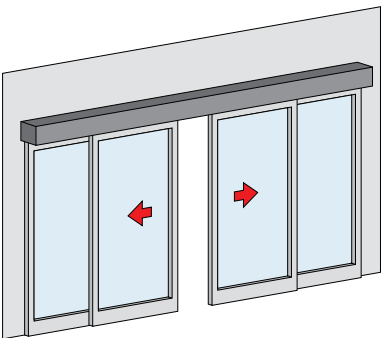

TWO SLIDING WINGS
TWO FIXED

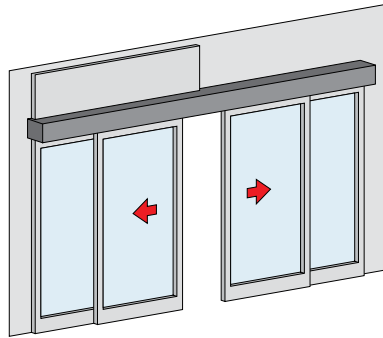

TWO SLIDING WINGS
TWO FIXED WITH TRANSOM



SLIDING OPENINGS WITH EMERGENCY OPENING DEVICE

EXAMPLES OF POSSIBLE CONFIGURATIONS

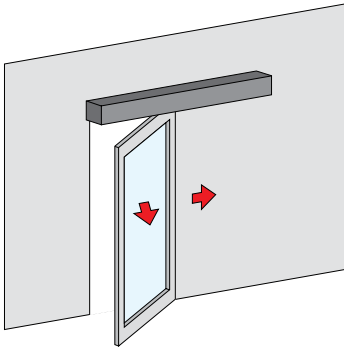

ONE SLIDING WING
WITH EMERGENCY OPENING
DEVICE ON A MOBILE WING

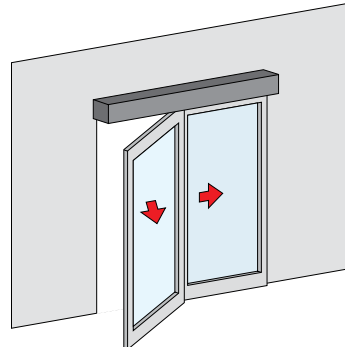

ONE SLIDING WING
ONE FIXED WITH EMERGENCY
DEVICE ON A MOBILE WING

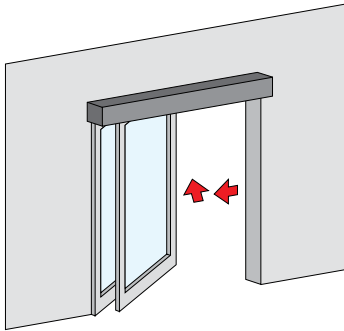

ONE SLIDING WING
ONE FIXED WITH FULL EMERGENCY
OPENING DEVICE

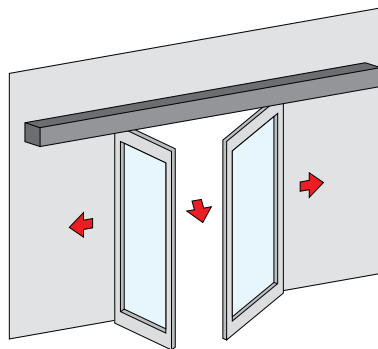

TWO SLIDING WINGS
WITH EMERGENCY OPENING DEVICE
ON MOBILE WINGS

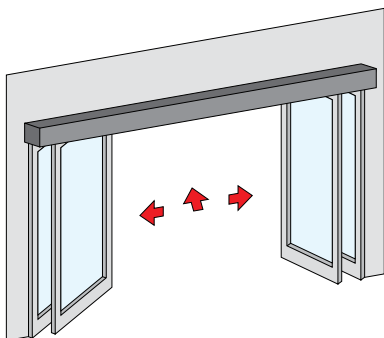

TWO SLIDING WINGS
TWO FIXED WINGS WITH FULL
EMERGENCY OPENING DEVICE

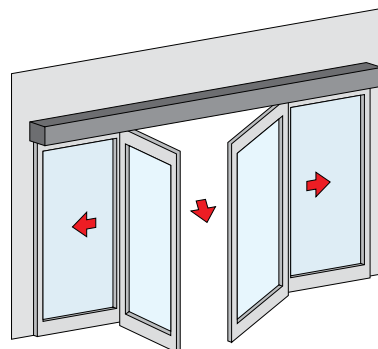

TWO SLIDING WINGS
TWO FIXED WINGS
WITH EMERGENCY OPENING DEVICE
ON MOBILE WINGS



EMERGENCY BREAK-OUT OPENING DEVICE

ASM-N MECHANICAL EMERGENCY BREAK-OUT OPENING DEVICE, FULL AND PARTIAL

**LAYOUT****The emergency break-out opening device**

is a safety device enabling mobile and semi-fixed wings of all types to be opened mechanically in the event of an emergency.

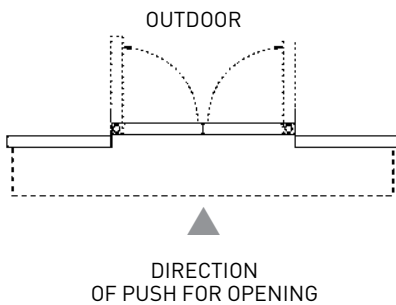
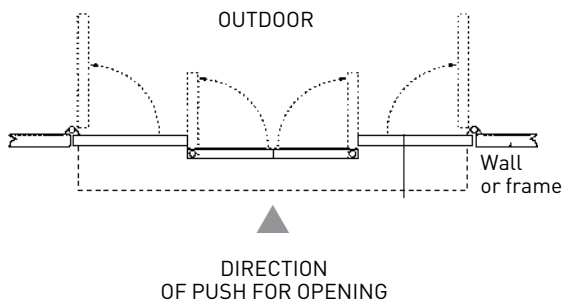
PARTIAL EMERGENCY OPENING DEVICE**FULL EMERGENCY OPENING DEVICE**

WARNING: In configurations where mobile wings equipped with ASM-N are joined to semi-fixed wings also equipped with emergency opening devices (full emergency opening device), it is necessary to fix the wings using the fittings supplied in the special set (optional).

NEWS: The spinning point for mobile wings and semi-fixed wings is located inside the profile. The set of fittings for semi-fixed wings are not visible and located inside the covering profile.

The ASM-N mechanical emergency break-out opening device can be used on wings with a maximum width of 1,200 mm and max. weight of 90 kg; and on wings with

a minimal width of 700 mm and max. weight of 120 kg (according to the table below) for a max. height of 2,400 mm.

Wing length mm	900	1,000	1,200	90
Max. wing weight* kg	120	110	100	90
ASM-N weight	7 kg			

*Overall weight including ASM-N

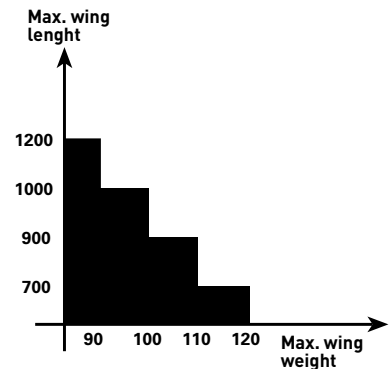
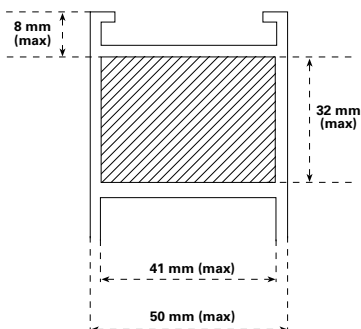
**THE ASM-N CAN BE USED WITH THE FOLLOWING TYPES OF PROFILES:**

**PROFILES
COMPATIBLE
WITH ASM-N
(NOT TYPE-
APPROVED)**

- Domalstopper PG
- Formula F40 system
- Metra NC 45 International
- Metra NC 55 International
- R50
- Modular APRIMATIC profiles*

If you cannot use the compatible profiles listed above, ensure that the profiles you use have the dimensions indicated above.

* For instructions on machining "Modular" profiles, request the cutting list.



EMERGENCY BREAK-OUT OPENING DEVICE

ASM-N EMERGENCY OPENING DEVICE

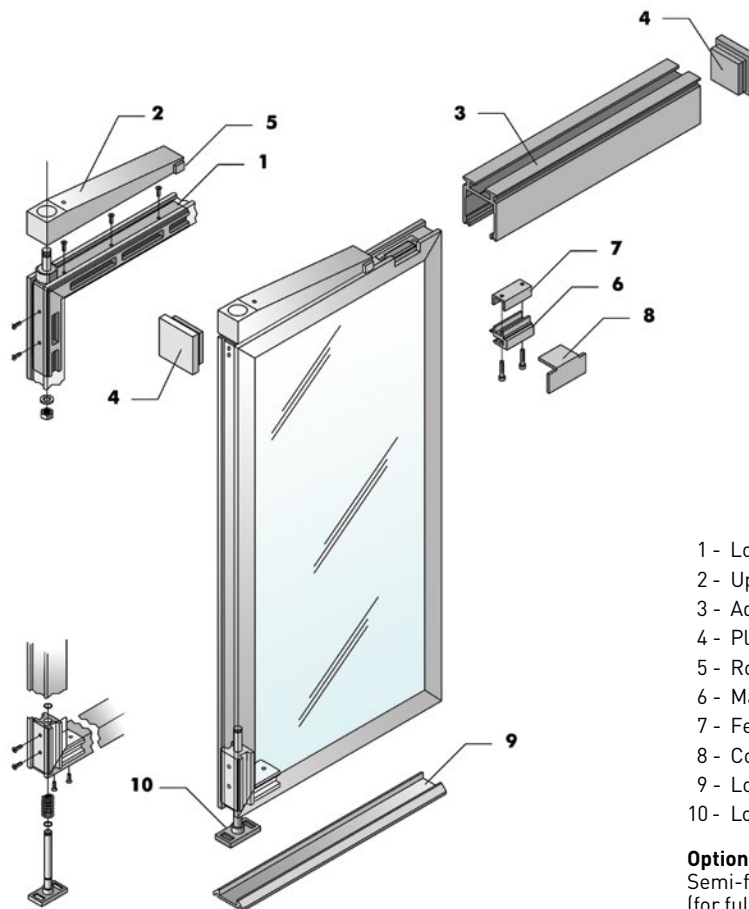

- 1 - Lower arm
- 2 - Upper arm
- 3 - Adapter profile
- 4 - Plugs for adapter profile
- 5 - Rough adjustment insert
- 6 - Male fitting
- 7 - Female fitting
- 8 - Cover plate
- 9 - Lower guide
- 10 - Lower guide slider Nuts, bolts and screws

Optional elements:
Semi-fixed wing fitting set
(for full emergency opening device)

MECHANICAL EMERGENCY BREAK-OUT OPENING DEVICE

MECHANICAL EMERGENCY BREAK-OUT OPENING DEVICE		
ITEM NUMBER	DESCRIPTION	€
42280/088	(*) Mechanical emergency opening device set for 1 mobile wing, device weight 7 kg	338,28
42280/081	(*) Guide (L=1,500 mm) and adapter (L=1,200 mm) set	76,07
42280/070	Set of fittings for 1 semi-fixed wing	122,72

NOTE: You should include the weight of the emergency opening device when calculating the wing weight. Max. wing weight = 90 kg for a length of 1,200 mm, including the emergency opener system (7 kg). (*) Both required for installation.

ACCESSORIES FOR MECHANICAL EMERGENCY BREAK-OUT OPENING DEVICE

ACCESSORIES USED TO STOP WING MOVEMENT IN THE EVENT OF EMERGENCY OPENING

OPTIONAL ACCESSORIES		
ITEM NUMBER	DESCRIPTION	€
42280/076	SMI - Magnetic lock sensor, recess mounted, to be connected as an N.C. contact in series with the reset button, on full emergency break-out opening devices, to be fitted on all semi-fixed wings	10,13
42280/075	SMS - Magnetic lock sensor, surface mounted, to be connected as an N.C. contact in series with the reset button, on full emergency break-out opening devices to be fitted on all semi-fixed wings	11,58
42300/007	ER6/N	143,96

NOTE: For technical details about the ER6N photocells, see the "Photocells" table (on "Control and safety devices" page).

NOTA: All prices are subject to variation.



SMALL PROFILES

PROFILES FOR AUTOMATIC DOORS SUITABLE FOR 10/11 MM THICK GLASS PANELS



"SMALL" series profiles **can be used to make wings** for automatic sliding doors. This profile has been designed and manufactured specifically for mobile wings, fixed side wings and semi-fixed side wings. In spite of its compact size, the profile is compatible with up to 10 mm thick glass panels.

EXAMPLE OF ONE OF THE POSSIBLE CONFIGURATIONS

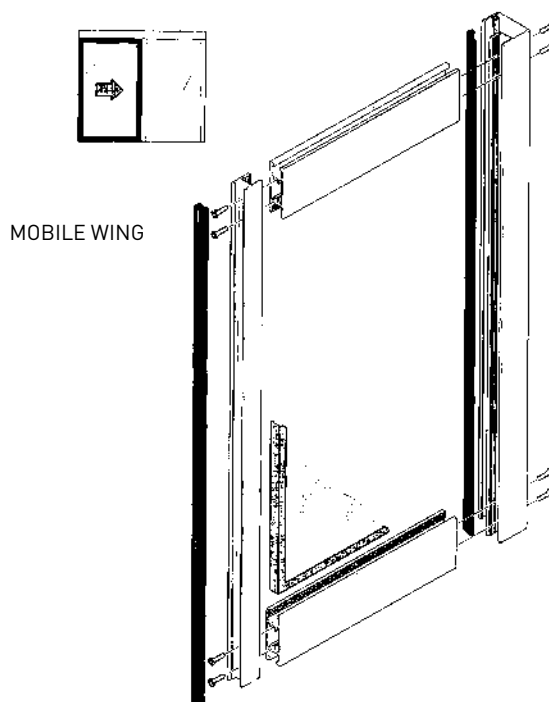
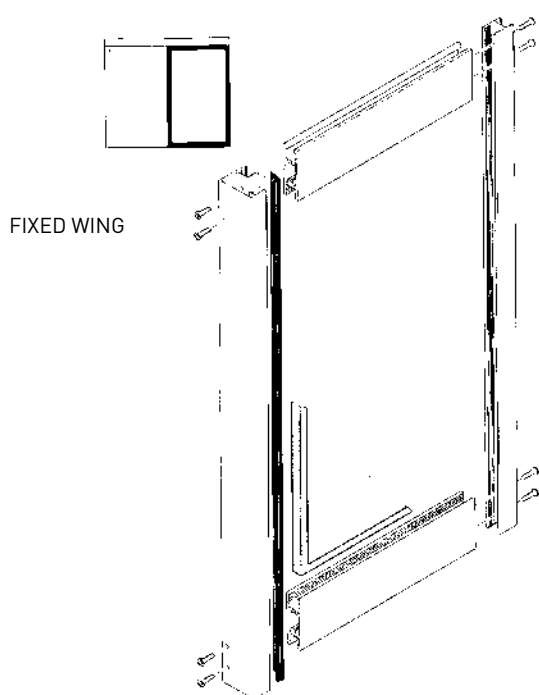



"SMALL" SERIES PROFILES

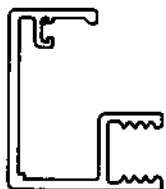

Fixed/mobile wing upright

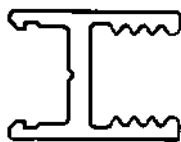

Central upright

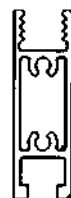

Top and bottom rail



Single wing stop





Central seal

Draught-proof seal
for overlap area

Side seal

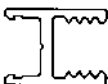
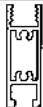

NOTE: All aluminium profiles are supplied non-anodised in lengths of 5050 mm.

"SMALL" SERIES PROFILES

	ITEM NUMBER	DESCRIPTION	€
	42200/012	"Small" mobile/fixed wing upright (srm)	70,22
	42200/013	"Small" central upright (L = 5050 mm)	37,45
	42200/014	"Small" top and bottom rail (L = 5050 mm)	87,20
	42200/015	"Small" single wing stop (L = 5050 mm)	22,23

NOTA: All prices are subject to variation.

**"SMALL" SERIES PROFILES**

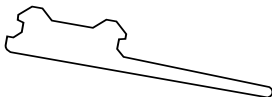
SEALS			
	ITEM NUMBER	DESCRIPTION	€
	42200/016	"Small" central seal (pack of 100 m)	5,26/m
	42281/060	Draught-proof seal for overlap area (pack of 1 m)	4,08 /m
	42200/054	"Small" side seal (pack of 80 m)	7,6 /m

NOTE: All seals necessary for wing assembly can be purchased to size in multiples of 1 metre.
This does not apply to adhesive seals; which are sold exclusively in packs of 50 metres.

FITTING ACCESSORIES			
	ITEM NUMBER	DESCRIPTION	€
	42200/053	Set of fixing screws for a small wing, required for assembly of automatic door wing profiles	5,26
	42200/051	Pack of inserts for assembling a fixed wing with "Small" profile	24,57

NOTE: For the fittings required to secure the mobile wing to the carriage and for the floor guide to be used with Small profiles, see the catalogue on page 186-187 (SPM and "Set of fixing screws for a small wing").



MODULAR PROFILES

IDEAL INSTALLATION

4 wing door, with 2 fixed and 2 sliding

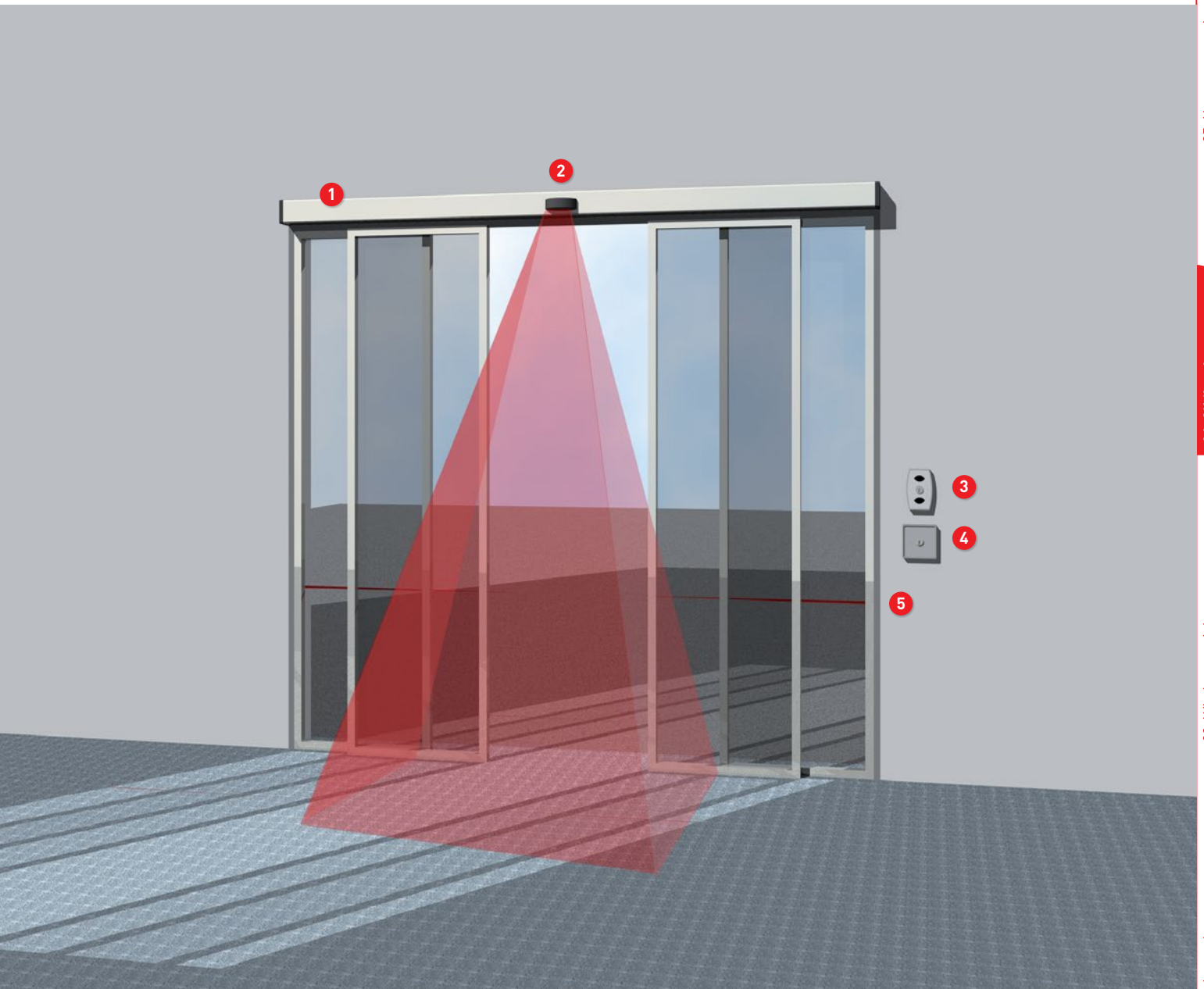

KEY

- 1 Automation module
- 2 Radar
- 3 Manual release
- 4 Control unit : key-operated switch / presence reader / keyboard combination lock / card reader / magnetic keys
- 5 Pair of photocells



MODULAR PROFILES

PROFILES FOR 9/13 mm AND 20/23 mm automatic doors

"MODULAR" profiles can be used for automatic sliding door wings. This profile has been specifically designed for the construction of fixed and mobile wings with or without mechanical emergency

break-out opening device (AMS) thus perfectly fitting in a system of windows and curtain walls providing a complete range of possible solutions.

The profile's modular construction, lends the wing a striking and aesthetically

pleasing look. "MODULAR" profiles complete the range of extruded wing elements and meet any installation requirements.

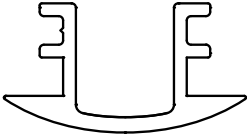
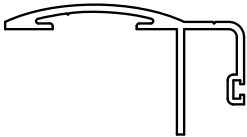
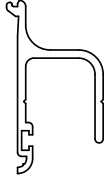
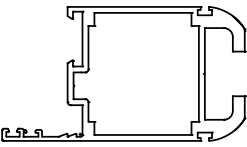
SEALS			
	ITEM NUMBER	DESCRIPTION	€
	42205/001	Upright cover (L = 5050 mm)	22,81
	42205/002	Wing mounting profile without fixed slide guide (L = 5050 mm)	52,08
	42205/003	Mobile wing mounting profile + fixed slide guide (L = 5050 mm)	37,45
	42205/004	Upright profile (L = 5050 mm)	131,67

NOTA: All prices are subject to variation.



SEALS

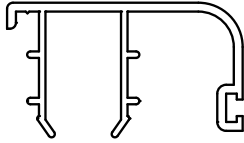
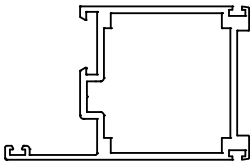
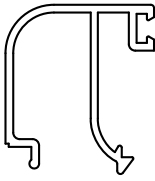
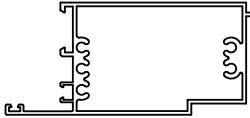

	ITEM NUMBER	DESCRIPTION	€
	42205/005	Photoelectric cell profile (L = 5050 mm)	32,77
	42205/006	Upper frame (L = 5050 mm)	108,81
	42205/007	Snap-type rounded glass beading (L 23) (L = 6500 mm)	30,42
	42205/008	Lower additional transom (L = 6500 mm)	151,54

NOTA: All prices are subject to variation.



MODULAR PROFILES

PROFILES FOR 9/13 mm AND 20/23 mm automatic doors

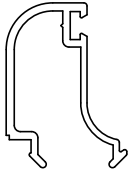
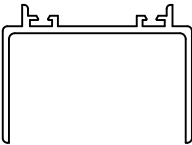
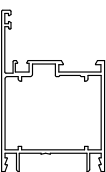
SEALS			
	ITEM NUMBER	DESCRIPTION	€
	42205/009	Horizontal 160 mm transom (L = 6500 mm)	212,39
	42205/010	Lower transom 160 mm (L = 6500 mm)	254,33
	42205/011	Snap-type rounded glass beading (L13) (L = 6500 mm)	25,74
	42205/012	Vertical wall-mounted compensator (L = 6500 mm)	59,06
	42205/015	"L" oversized fixed frame (L = 6500 mm)	105,33



SEALS

	ITEM NUMBER	DESCRIPTION	€
	42205/016	"R" oversized fixed frame (L = 6500 mm)	120,51
	42205/017	Outward-opening oversized wing (L = 6500 mm)	118,21
	42205/019	Blind glass beading (L = 6500 mm)	31,60
	42205/061	Central seal (100 m)	373,98



OVER/ OVER HEAVY / OVER EVO

NEW**24**
V_{cc}**i228****i229**

Automation for indoor swing doors, of max. weight 300kg. Continuous use.



TECHNICAL DATA	OVER	OVERHEAVY	OVER EVO
POWER SUPPLY		100/240 V - 50/60 Hz	
MOTOR POWER SUPPLY		24 V	
ACCESSORY		12 V cc - 1A max.	
POWER SUPPLY			
THRUST FORCE	20 Nm	40 Nm	23 Nm
MAX WEIGHT		300 kg	220 kg
APPLICABLE TO THE WING	200 kg		
ABSORBED POWER	40 W	70 W	70 W
MAX.WING WIDTH	L=1200 mm	L=1500 mm	L=1200 mm
USE FREQUENCY		S3 = 100% - continuous	
OPENING ANGLE		100° max.	
OBSTACLE DETECTION		YES adjustable	
MAX. SPEED OPENING		2-6 s	
OPERATING TEMPERATURE		- 15° C / + 50° C	
EMERGENCY BATTERY		YES optional	
PROTECTION DEGREE		IP20	
CERTIFIED		EN16005	



OVER series, is equipped with encoder, a device through which you can control and manage with the utmost precision the engine and the port status in any use condition.

Maximum safety is guaranteed by OVER's many functions. The OBSTACLE DETECTION function, available thanks to the encoder, stops the door and/or reverses the wing movement direction when an obstacle is detected.

EMERGENCY opening mode, in case of a power failure, which allows the automation system to place the door in the OPEN position and STOP condition or, at the discretion of the user, allows the continuous operation of the door thanks to the optional backup battery.

The PUSH&GO function enables OVER to recognise when the door is being pushed by hand and therefore allow door opening.

OVER and OVER HEAVY are available with opening and closing to motor; while OVER EVO with opening at motor and closing with spring, guarantee a safety closing also in blackout situation.

New technology brushless motor for greater durability, reducing the frequency of maintenance.

ARTICULATED ARM

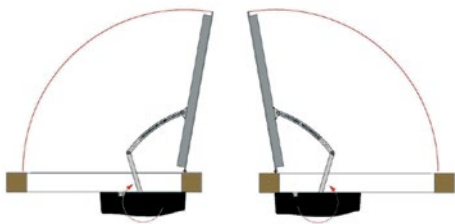

Use the ARTICULATED ARM for door opening outwards from the automation side.

SLIDING ARM

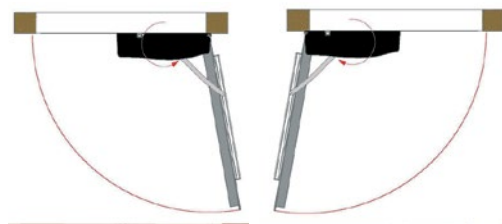

Use the SLIDING ARM for doors opening inwards from the automation side.

DRIVE SYSTEM FOR INDOOR SWING DOORS

ITEM NUMBER	DESCRIPTION	€
42605/001	OVER (grey cover)	899,00
42605/002	OVER HEAVY (grey cover)	1699,00
42605/003	OVER EVO (grey cover)	1299,00

COMPULSORY CONTROL ACCESSORIES

ITEM NUMBER	DESCRIPTION	€
42605/050	Articulated arm : for use with doors opening outward	115,00
42605/051	Sliding arm : for use with doors opening inwards	83,00
42605/056	Spacer 17mm (only for OVER model)	36,00
42605/057	Spacer 51mm	47,00
42605/058	Spacer 68 mm	71,50
42605/059	Spacer 85mm	74,50

ACCESSORIES

ITEM NUMBER	DESCRIPTION	€
41923/009	RR-SE - Unico 433.92 MHz Memory System superheterodyne receiver	88,67
42282/096	RSH - Swing door safety sensor (active infrared distance measurement technology)	379,84
RADAR:		
42282/092	RI-H5 - Medium-range combined door activation and safety sensor with 4 detection rows	234,09
42283/094	DM-M Microwave monodirectional radar	196,64
42605/060	TOUCH T Function selector	289,00
42605/061	SEL F 3 position selector	40,00

NOTE: for other control and safety devices, see page 176.

SEL F 3 POSITION SELECTOR

Select basic door operating modes.



TOUCH T

Select door operating modes. Parameters configuration.



NOTA: All prices are subject to variation.



05.

HOME AUTOMATION

ADI
MODULES

M230HR
M230S
RX230

MOTOR
CONTROL UNITS
AND ACCESSORIES

CV1N
CV10
CF10/2
PV1
PV2
RAIN/WIND/SMOKE SENSORS

ADI



ADI



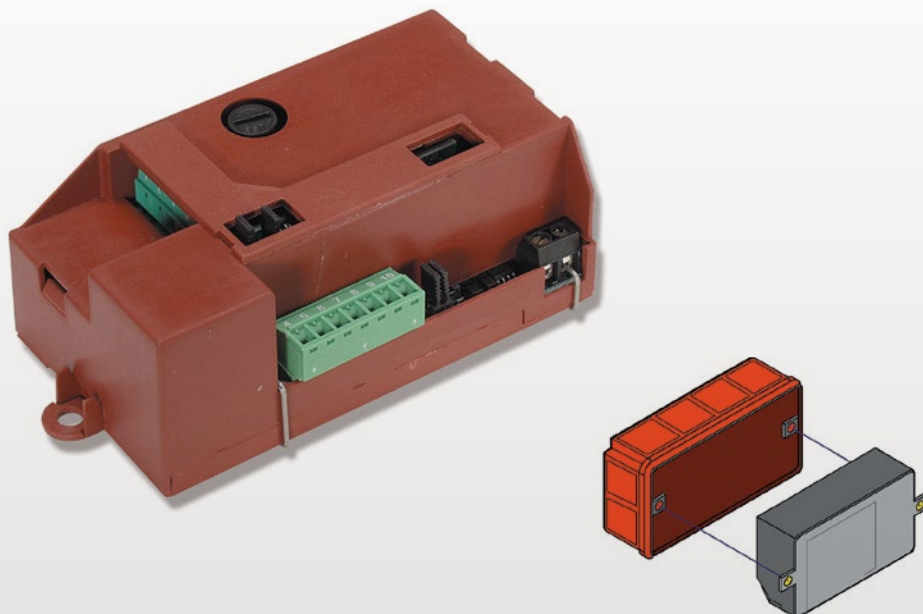

4-module flush-mounting box

ADI MODULES - MOTOR CONTROL

Radio-controlled equipment for the automation of door, window and shutter motors, lights, fans, solenoid valves, small domestic loads with 230 Vac power supply.

Cost-effective solutions for the most common automation needs in the residential and service sectors (homes, offices, shops, hotels, etc.).

The indoor modules can also be installed in 4-module flush-mounting boxes, using the appropriate fixing tabs.

Suitable for systems with different levels of complexity: from individual automation systems to coordinated systems.

Ease of installation and commissioning, built-in antenna. Wired and wireless centralised operation.

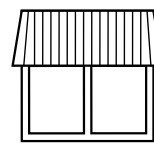
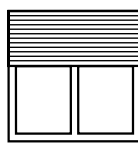
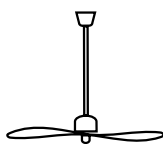
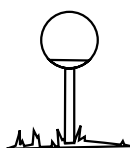
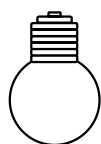

ADI MODULES - MOTOR CONTROL

INDIVIDUAL RADIO CONTROL: M230HR

Radio control with portable two-channel transmitters (TM4) or wall-mounted transmitters (TP2-BN, TP2-NR).

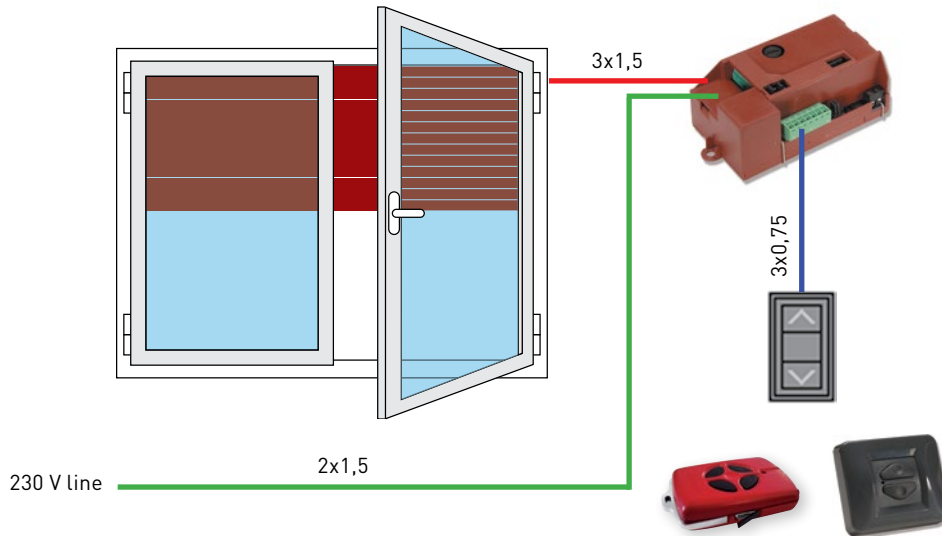

INDIVIDUAL WIRED AND WIRELESS CONTROLS: M230HR

Individual low-voltage wired control with standard, even pre-existing, push-buttons and radio control with portable

two-channel transmitters (TM4) or wall-mounted transmitters (TP2-BN, TP2-NR).

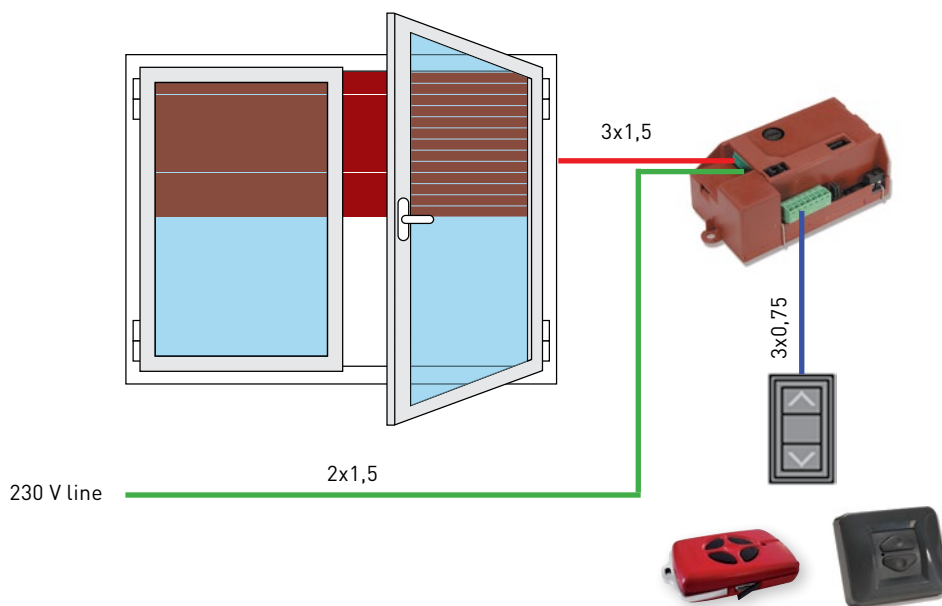

ADI MODULES - MOTOR CONTROL

INDIVIDUAL WIRED AND MULTIPLE WIRELESS CONTROLS: M230HR

Individual low-voltage wired control with standard, even existing push-buttons and wireless control with portable

multichannel transmitters (TM4, TR14). Simple configuration allows all modules to be controlled from a single remote control.

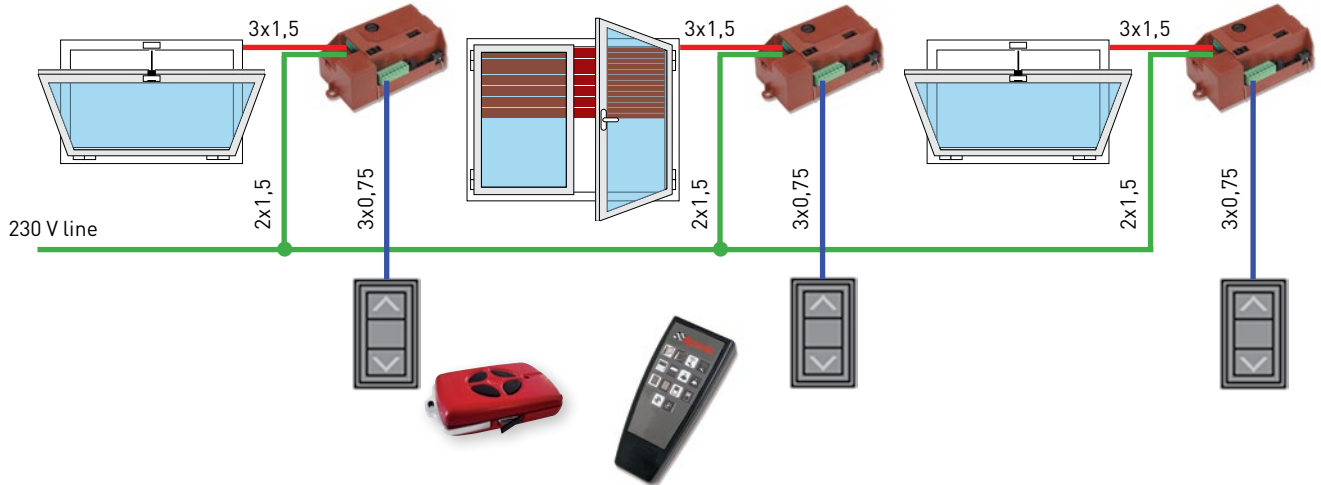

CENTRALISED WIRED AND WIRELESS CONTROLS: M230HR

Indoor modules can receive individual controls and centralised priority wired controls. Such controls can come from timers, weather units, alarm systems etc. as well as from simple manually-operated switches. Priority centralised controls take precedence over local controls as long as

they remain active or until the end of the operation. Priority centralised controls can be used to create simple but effective coordinated control "scenarios": for instance, in an office, with a single pulse control it is possible to implement an "exit" scenario that provides for the closing of all windows and turning off of all lights.

The same functions can be achieved with wireless controls, simply by configuring the control modules. For example a TR14 remote control can be used to control "scenarios" as well as controlling individual operators.

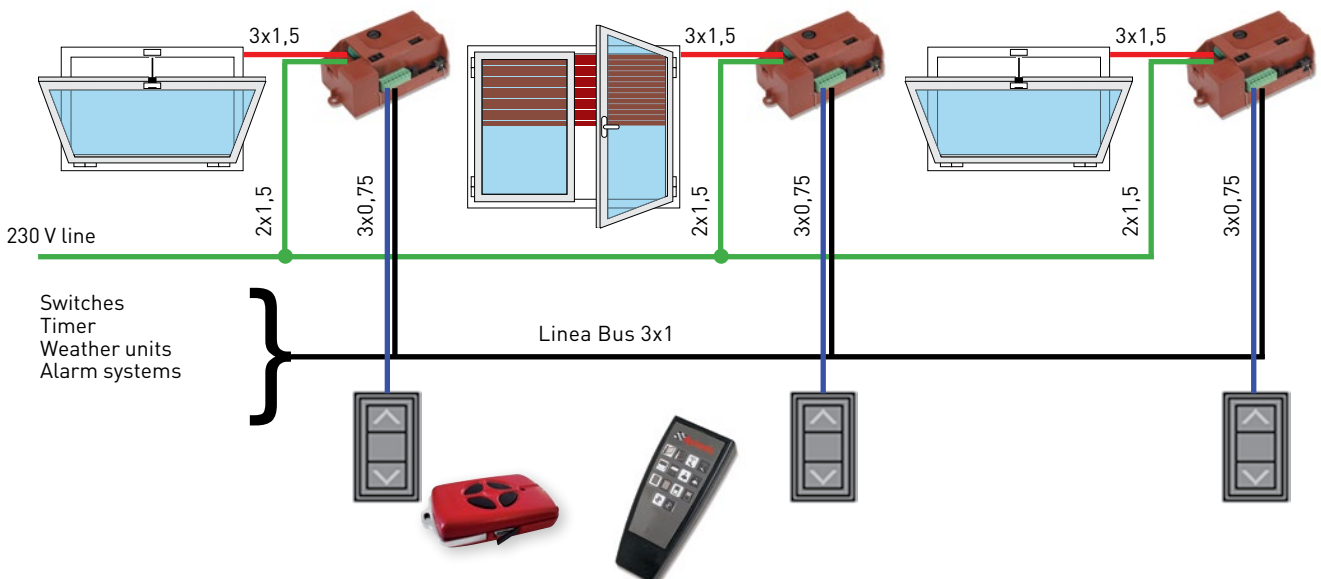



ADI MODULES - MOTOR CONTROL

INDIVIDUAL WIRED AND WIRELESS CONTROL: M230S

Low-voltage wired control with standard outdoor push-button and wireless control with portable two-channel transmitters

(TM4) or wall-mounted transmitters (TP2-BN, TP2-NR).

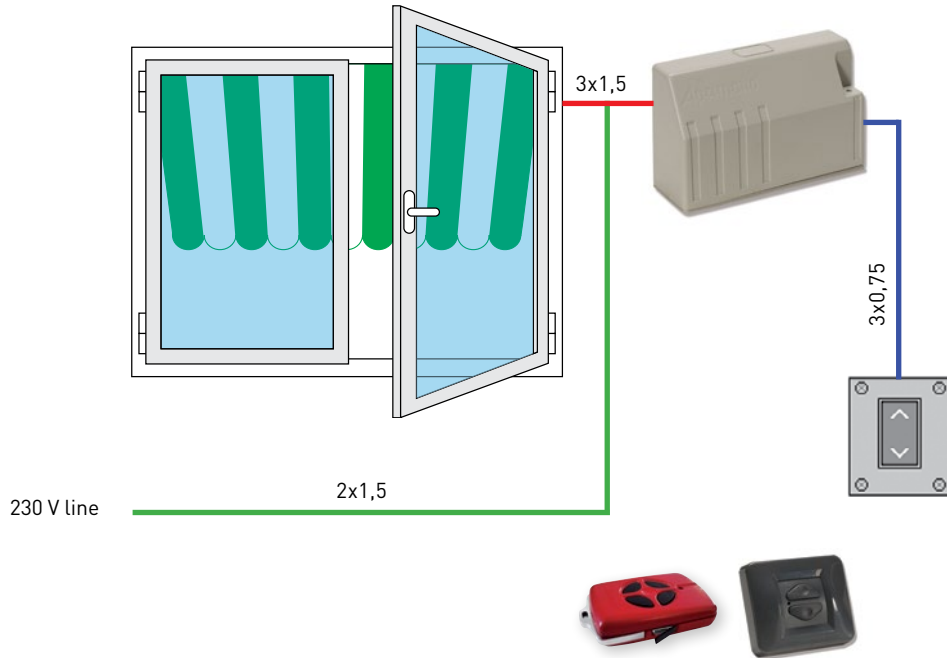

USE WITH WEATHER UNIT: M230HR

Automatic closing control from a weather unit on dedicated priority input.

Low-voltage wired control with standard outdoor switch and wireless control with portable two-channel transmitters (TM4)

or wall-mounted transmitters (TP2-BN, TP2-NR).

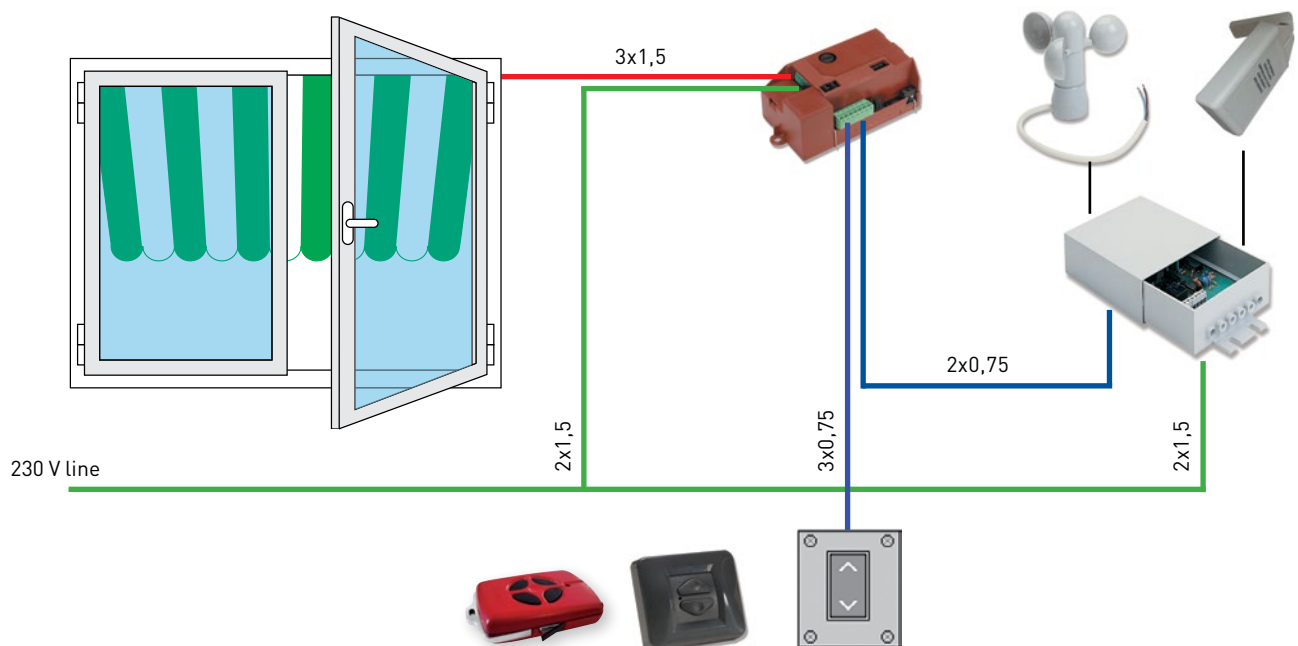

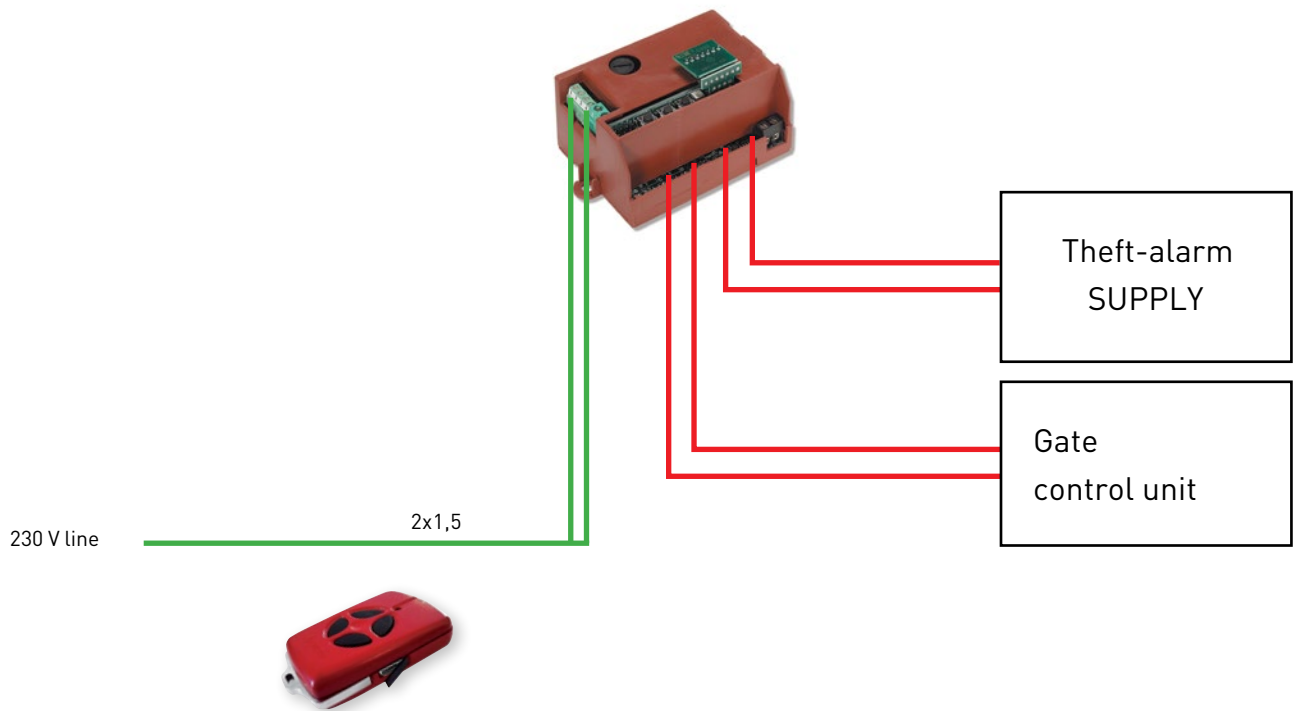

ADI MODULES - RX230 RECEIVER MODULE

2-channel receiver module with 2 clean contacts for controlling low-voltage loads or pulse control for gate control units, theft-alarm etc.



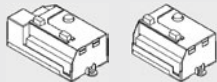

ADI MODULES - MOTOR CONTROL

TECHNICAL DATA	M230HR	M230S
POWER SUPPLY	Single-phase 230 Vac (+ 6% - 10%) - 50 Hz	
MOTOR VOLTAGE	230 Vca	230 Vca
PROTECTION FUSE	5 A	5 A
MAX. POWER W	600	650
EQUIPMENT CONSUMPTION	2 W max.	2 W max.
ACCESSORY POWER SUPPLY 24 VDC	Not available	300 mA max.
ACCESSORY POWER SUPPLY PROTECTION. FUSE	Not available	500 mA
MAX. SECTION OF POWER SUPPLY CABLES	1,5 mm ²	2,5 mm ²
MAX. SECTION OF MOTOR CABLES	1,5 mm ²	2,5 mm ²
MAX. SECTION OF CONTROL CABLES	1 mm ²	2,5 mm ²
RADIO FREQUENCY	433.92 Mhz	433.92 Mhz
USEFUL RANGE	120 metres in free field with optional antenna	
OPERATING TEMPERATURE	-20° +70° C	-20° +70° C
STORAGE TEMPERATURE	-40° +85° C	-40° +85° C
RELATIVE HUMIDITY	90% max. (non condensing)	90% max. (non condensing)
PROTECTION DEGREE	IP20	IP44
INSTALLATION	Indoors, in a dry, not dusty area	Outdoors
MODULE CONTAINER		

FEATURES	M230HR	M230S
Local opening	Removable terminal board	Terminal board
Local closing	Removable terminal board	Terminal board
Centralised opening	Removable terminal board	Not available
Centralised closing	Removable terminal board	Not available
Stop	Removable terminal board	Terminal board
Safety device	Removable terminal board	Terminal board

OPERATING MODES	M230HR	M230S
Local opening	YES	YES
Local closing	YES	YES
Centralised opening	YES	~
Centralised closing	YES	~
Stop	YES	YES
Dead man	YES	YES
Semi-automatic open/close	YES	YES
Semi-automatic step-by-step	YES	YES
Automatic	YES	YES

OUTPUTS	M230HR	M230S
Outputs	2 relays for motor control with HW and SW interlock	

OTHER FUNCTIONS	M230HR	M230S
Wireless control memorisation:	Wireless self-learning - Max. 496 different users	

CONFIGURATIONS	M230HR	M230S
Operating time	On module and wireless	On module and wireless
Pause time	On module and wireless	On module and wireless
TX buttons - Wireless controls	On module and wireless	On module and wireless

PRESETS	M230HR	M230S
Operating logics	Semi-automatic Open/Close	
Operating time	45 s (programmable from 0 to 180 seconds)	
Pause time	45 s (programmable from 0 to 180 seconds)	
Stop input	Disabled (JP5 closed)	
Safety device input	Disabled (JP6 closed)	

ADI MODULES - LIGHT CONTROL



TECHNICAL DATA	RX230
POWER SUPPLY	Single-phase 230 Vca (+ 6% - 10%) - 50 Hz
LOAD VOLTAGE	0-24 Vcc Vca
PROTECTION FUSE	3,15 A
EQUIPMENT CONSUMPTION	2 W max.
MAX. SECTION OF POWER SUPPLY CABLES	1,5 mm ²
MAX. SECTION OF CABLES FOR LOADS	1,5 mm ²
MAX. SECTION OF CONTROL CABLES	~
RADIO FREQUENCY	433.92 Mhz
USEFUL RANGE	120 metres in free field with optional antenna
OPERATING TEMPERATURE	-20° +70° C
STORAGE TEMPERATURE	-40° +85° C
RELATIVE HUMIDITY	90% max. (non condensing)
PROTECTION DEGREE	IP20
INSTALLATION	Even outdoors
MODULE CONTAINER	

LOAD CONTROL	rx230
No. of relays	2
MAX. APPLICABLE LOADS	
Induction motor or transformer	1 A
Resistive load	1 A
Incandescent lamp	1 A
Fluorescent lamp	1 A
WIRED INPUTS	
Channel 1 control	~
Channel 2 control	~
Centralised activation	~
Centralised deactivation	~
WIRELESS INPUTS	
Channel 1 control	YES
Channel 2 control	YES
Centralised activation	~
Centralised deactivation	~
OPERATING MODES	
ON/OFF	YES
Timer 1-255 seconds	YES
Timer 1-255 minutes	YES
Dead man	YES
OTHER FUNCTIONS	
Wireless control memorisation:	Wireless self-learning - Max. 496 different users
CONFIGURATIONS	
Channel 1 timer	On module and wireless
Channel 2 timer	On module and wireless
TX buttons - Wireless controls	On module and wireless
PRESETS	
Operating logics	ON/OFF
Channel 1 timer	1 second
Channel 2 timer	1 second



ADI MODULES - ACCESSORIES







MOTOR CONTROL MODULES

	ITEM NUMBER	DESCRIPTION	€
	43665/004	M230HR - 230 Vac motor control module, wired and wireless control, indoor installation, suitable size for installation in "504" flush-mounting box	119,97
	43665/015	M230S - 230 Vac motor control module, wired and wireless control, max. 300 mA accessory power supply, outdoor installation in IP44 box	116,48
	43645/004	MCT - Centralised-operation control module for tubular motors with interface card specifically for the control of several parallel-connected tubular motors	41,33

TWO-CHANNEL RECEIVER MODULES

	ITEM NUMBER	DESCRIPTION	€
	41923/055	RX230 - Two-channel receiver module with 2 clean contacts for controlling low-voltage loads or pulse control for gate control units, theft-alarm etc., suitable size for installation in "503" flush-mounting box	113,58

ACCESSORI

	ITEM NUMBER	DESCRIPTION	€
	41929/001	ANT433 - 433.92 MHz external antenna with 4.5 m coaxial cable and ground connection in combination with 43665/004 or 43665/015 or 41923/055	19,12
	41905/004	TM 4 - 433.92 MHz four-channel remote control	38,41
	41903/014	TR14 - 433.92 MHz 14-channel portable remote control	282,63
	41905/001	TP2-BN - White wall-mounted two-channel 433.92 MHz remote control, compatible with BTicino living International/Light wiring systems	65,22
	41905/002	TP2-NR - Black wall-mounted two-channel 433.92 MHz remote control, compatible with BTicino living International/Light wiring systems	65,22
	43701/050	PP-BN - Plate for white wall-mounted remote control	9,89
	43701/051	PP-NR - Plate for black wall-mounted remote control	9,89

NOTE: All prices are subject to variation.

MOTOR CONTROL UNITS, WEATHER UNITS AND ACCESSORIES

24 V AND 230 V MOTOR CONTROL UNITS, WEATHER UNITS, RAIN, WIND, SMOKE SENSORS.

MATCHING OF MOTOR CONTROL UNITS WITH OPERATORS AND WEATHER UNITS					
		24 V			230 V
		CV1N	CV10	CF10/2 *	4M
OPERATOR					
POWER SUPPLY 24 V	O2M 24 V 	~	4 Motors	4 Motors	~
	APRICOLOR VARIA 24 V 	~	4 Motors	4 Motors	~
	DUO SYSTEM 24V 	1 Motors	10 Motors	10 Motors	~
POWER SUPPLY 230 V	APRILINEARE 230 V 	~	~	~	4 Motors
	WI-MATIC ATC300E 	~	~	~	4 Motors
	APRICOLOR VARIA - VARIA T 230 V 	~	~	~	4 Motors
	ST 450 N 	~	~	~	4 Motors
	DUO SYSTEM 230V 	~	~	~	4 Motors
	TUBULAR REVOLUX 	~	~	~	4 Motors

WEATHER UNITS				
PV1 230 V 	YES	YES	YES	YES
PV2 24 V 	YES	~	YES	~

NOTE: PV1 and PV2 control units can be installed with:



RV - Anemometer



SP1 - Rain sensor

NOTE: * The CF10/2 control unit can be installed with:



Detector:
Smoke, Heat or Smoke/Heat





Buffer battery





MOTOR CONTROL UNITS, WEATHER UNITS AND ACCESSORIES



MOTOR CONTROL UNITS

	ITEM NUMBER	DESCRIPTION	€
	43660/002	CV1N - 24 Vdc max. 1A motor control unit, inputs for local and centralised opening and closing commands, power adjustment potentiometer 300 mA to 600 mA, 24 Vdc accessory power supply, can be connected in parallel with other CV1N units	253,66
	43660/007	CV10 - 24 Vdc max. 8A motor control unit, inputs for local and centralised opening and closing commands, can be connected in parallel with other CV10 units	165,98
	43645/005	4M - control unit for simultaneous control of four 230 Vac motors, inputs for local and centralised opening and closing commands, can be connected in parallel with other 4M units	214,91
	43660/006	CF10/2 - motor control unit (up to ten 24 Vdc max. 8A motors), 24Vdc max. 500 mA accessory power supply output, preset for backup battery and recharge circuit, built-in control panel for operators, rain/wind sensor and thermostat management, indicator LEDs, internal emergency thermostat triggered at +70° C, 2.2 KOhm balance line for max. 24 smoke and heat detectors, remote alarm signalling output	485,16

ACCESSORIES - CF 10/2

	ITEM NUMBER	DESCRIPTION	€
	43660/101	CF10/2 - Backup battery (no.2 x 12V - 5Ah batteries)	173,56
	43701/063	RFC - Optical smoke detector with differential heat sensor, compliant with EN54 standards (for max. area 60 m2 and height 12 m)	195,69

WEATHER UNITS AND SENSORS

	ITEM NUMBER	DESCRIPTION	€
	43665/018	PV1 (power supply 230 Vac)	74,55
	43660/008	PV2 (power supply 24 Vdc)	67,55
	PV1 and PV2 weather units can be connected to an anemometer and/or rain sensor to provide an alarm signal output (normally-open relay with no-voltage contacts) that can be used to send closing commands		
	43701/055	RV - Anemometer	42,51
	43701/052	SP1 - Rain sensor	84,44

NOTE: All prices are subject to variation.



TECHNICAL INFO

RAIDER 2500
AP424 - AP423
AP350
FLEXI 300
TWENTY 270
FORTY 270 - 390
EM73N
ZT70
ZT71
ONDA424
ONDA624
ONDA623
ONDA800E / ONDA801E
AT80E
ONDA 2000 / 2001

AT 86T / AT88T
AT 90T / AT92 T
ALZO
AT50
GA-MATIC CF800 / CF1000
HARRIER 4000R / HARRIER 4000I
HARRIER 6000I / HARRIER 8000I
BUONGIORNO
O2M
APRICOLOR VARIA
ST450N
APRILINEARE
DUO SYSTEM
520 / 600RF - 520 / 700RF
OVER / OVER HEAVY / OVER EVO

i





RAIDER 2500



OPERATOR DIMENSIONS

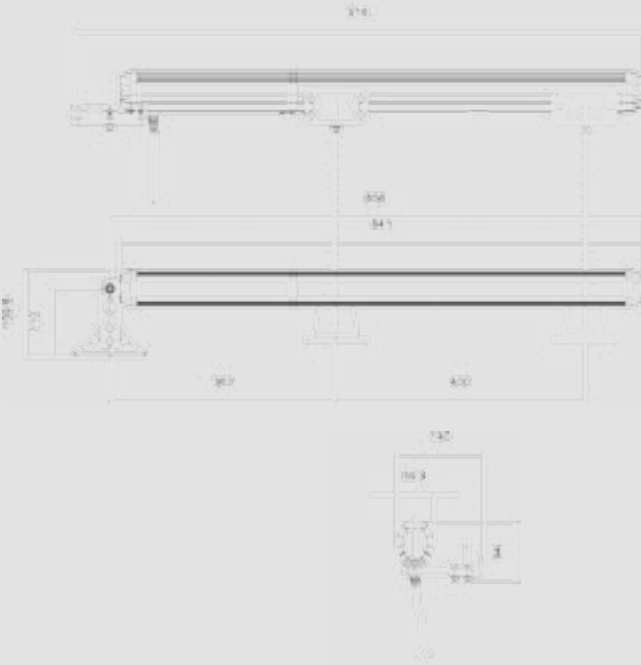

OPERATOR POSITIONING

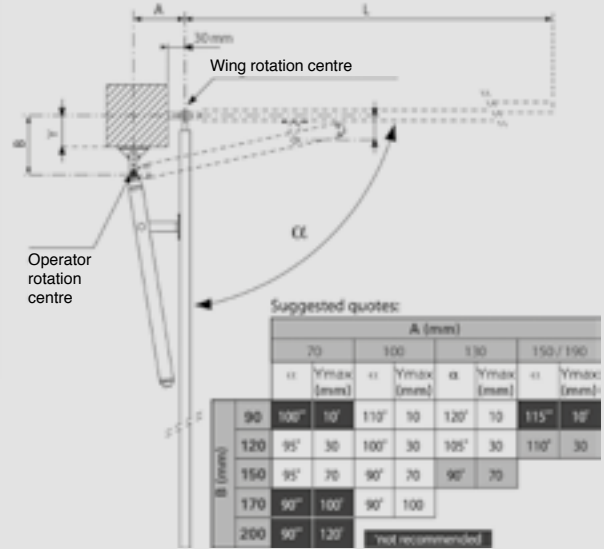

AP424 / AP423



OPERATOR DIMENSIONS

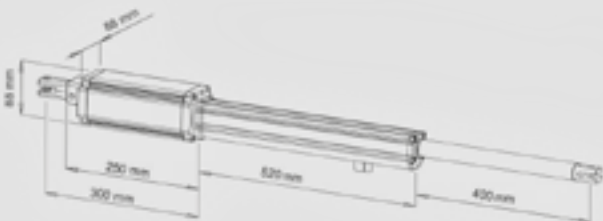

OPERATOR POSITIONING

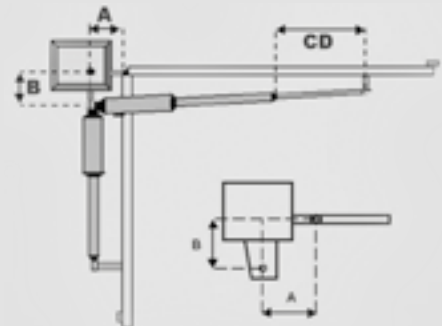

Degrees	A	B	Cu
90° Available stroke = 400mm	160	160	320
	175	175	350
	190	190	380
	200	200	400



FLEXI 300



OPERATOR DIMENSIONS



OPERATOR POSITIONING

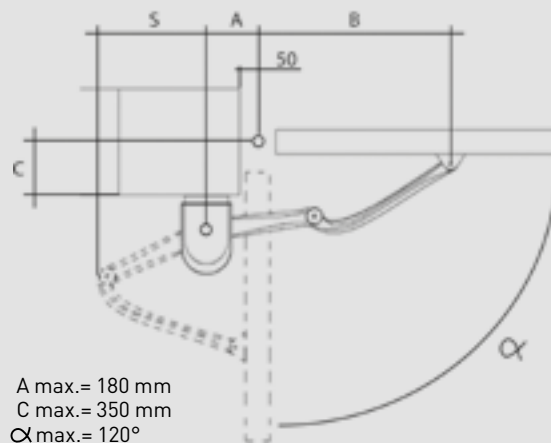

AP350



OPERATOR DIMENSIONS

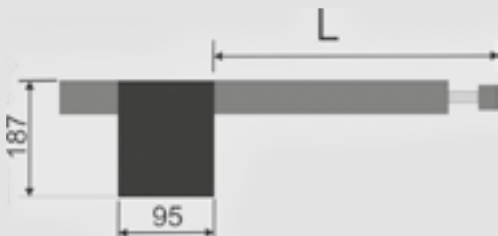

OPERATOR POSITIONING

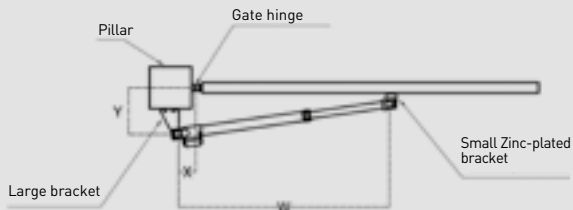

L min	L max
770 mm	1130 mm

Type	95° rotation			110° rotation		
	W	X	Y	W	X	Y
400	1130	160	210	1130	170	160





TWENTY 270



OPERATOR DIMENSIONS

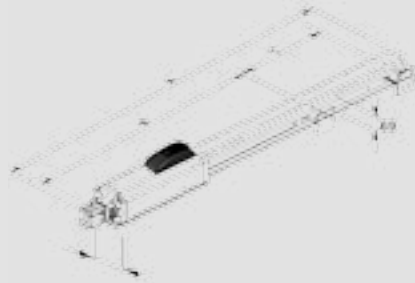

Model	DIMENSIONS (mm)		
	Length (A)	Distance attacks (B)	Rod stroke (C)
TWENTY 270	990	723	270

OPERATOR POSITIONING

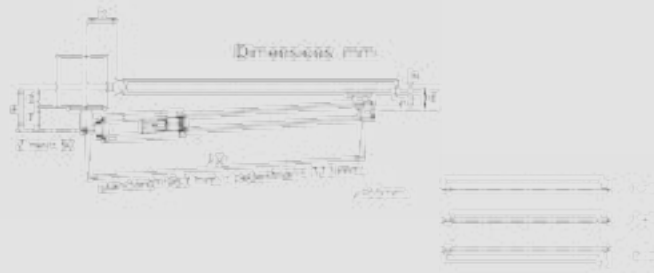

Table A: Dimensions recommended for standard operators

Opening angle	a (mm)	b (mm)	c (*) (mm)	d (**) (mm)
90°	130	140	270	90

(*) rod stroke required to stem (**) max dimensions

c= The stroke of the rod is less than the maximum stroke in order the piston internally reaching its stop in the opening and closing phases

FORTY 270 / 390



OPERATOR DIMENSIONS

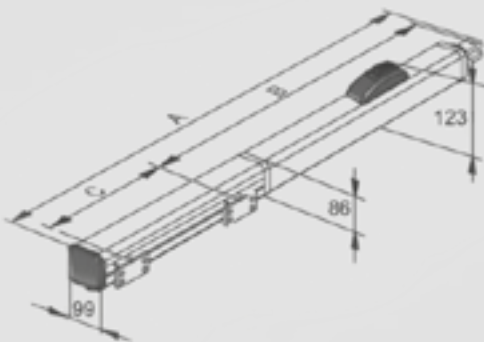

Model	DIMENSIONS (mm)		
	Length (A)	Distance attacks (B)	Rod stroke (C)
FORTY 270	1090	705	270
FORTY 390	1330	825	390

OPERATOR POSITIONING

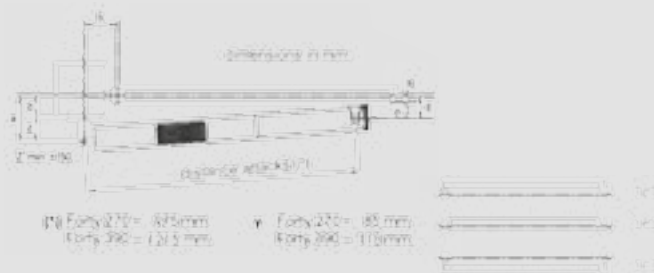

Table "A": Forty 270 - Fixing brackets

Opening angle	a (mm)	b (mm)	c (*) (mm)	d (**) (mm)	s (mm)
90°	130	130	270	80	20
115°	100	120	270	50	20
125°	90	120	270	40	0

(*) rod stroke required to stem the hydraulic slowdown in the closing (**) max dimensions

Table "B": Forty 390 - Fixing brackets

Opening angle	a (mm)	b (mm)	c (*) (mm)	d (**) (mm)	s (mm)
90°	200	160	390	150	20
115°	170	160	390	110	20
125°	130	170	390	80	20

(*) rod stroke required to stem the hydraulic slowdown in the closing (**) max dimensions



EM 73N



OPERATOR DIMENSIONS

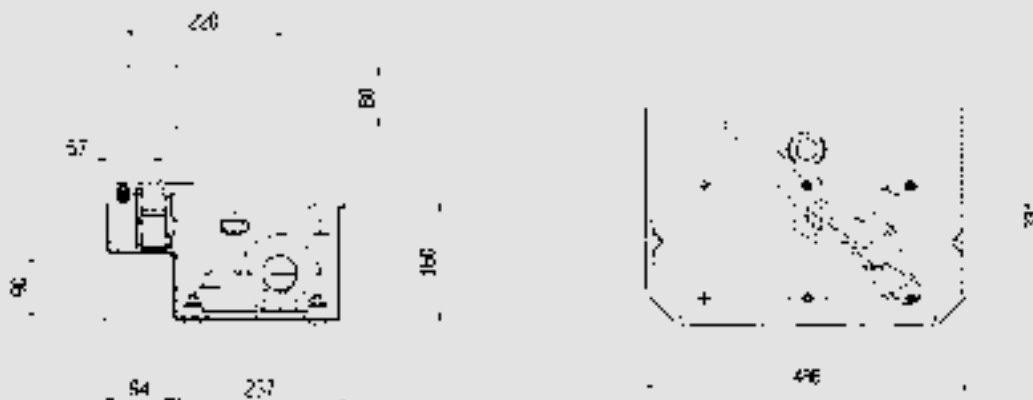

ZT 70



DIMENSIONS CIA 170 (underground box)



NOTE : Always include a rainwater drain





ZT 71



DIMENSIONS CIA171 (underground box)



NOTE : Always include a rainwater drain

ONDA 424



OPERATOR DIMENSIONS

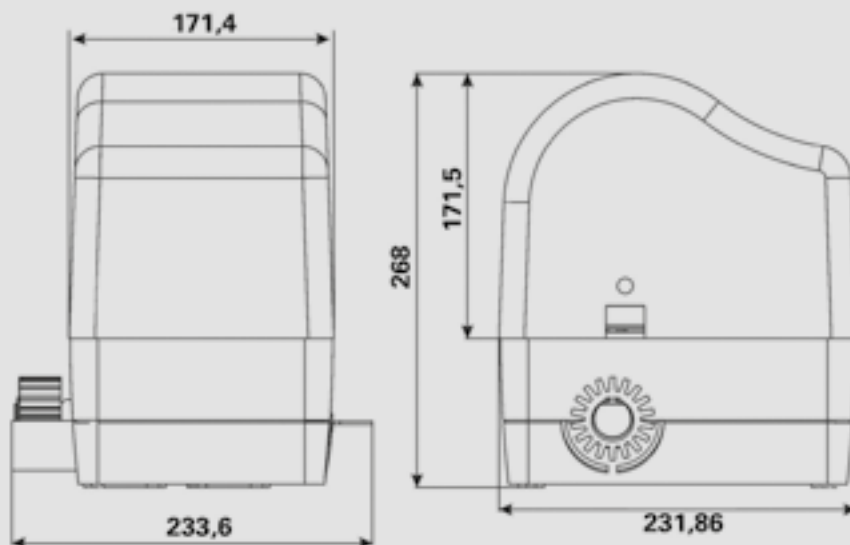



ONDA 623



OPERATOR DIMENSIONS

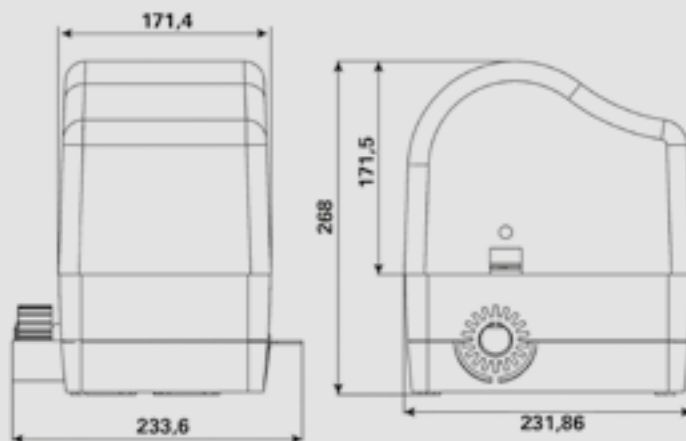

ONDA 624



OPERATOR DIMENSIONS

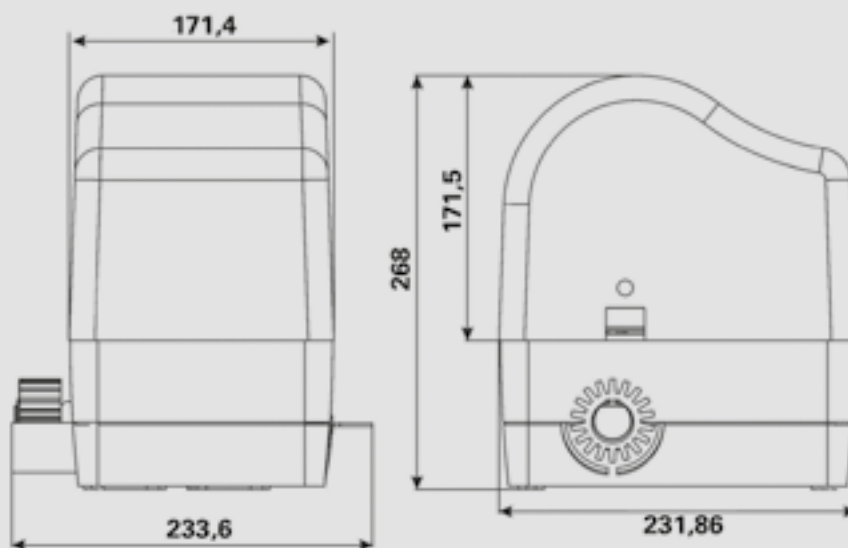



ONDA 800E / 801E



OPERATOR DIMENSIONS

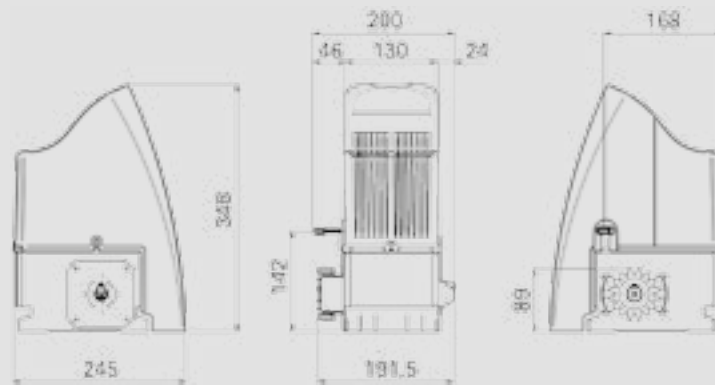

AT 80E



OPERATOR DIMENSIONS

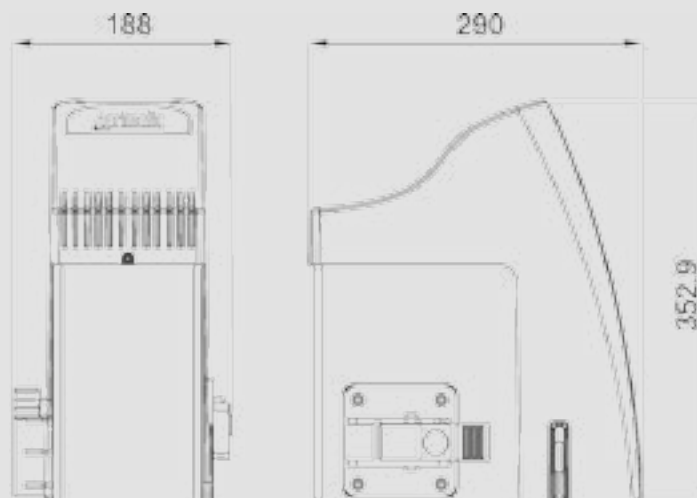



ONDA 2000 / 2001



OPERATOR DIMENSIONS





AT 86 / AT 88T

DIMENSIONS

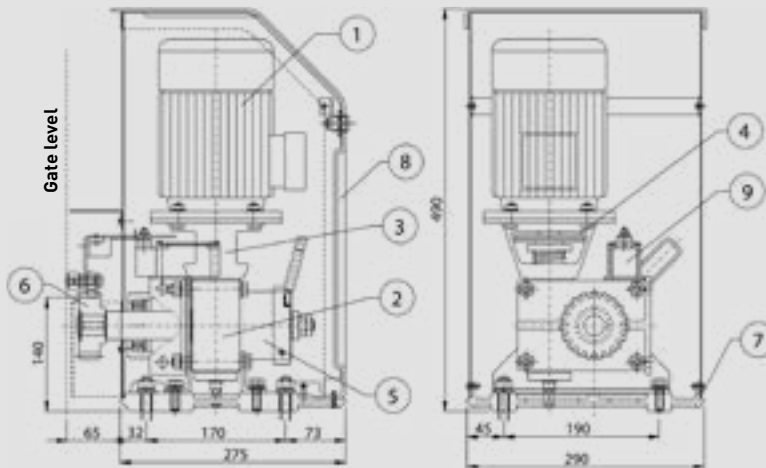

AT 86 GEAR MOTOR MAIN PRODUCT ITEMS:

- 1- Motor
- 2- Worm screw reduction unit
- 3- Bell type coupling
- 4- Single disk dry clutch
- 5- Release device
- 6- Pinion
- 7- Support base
- 8- Door
- 9- Mechanical limit stop

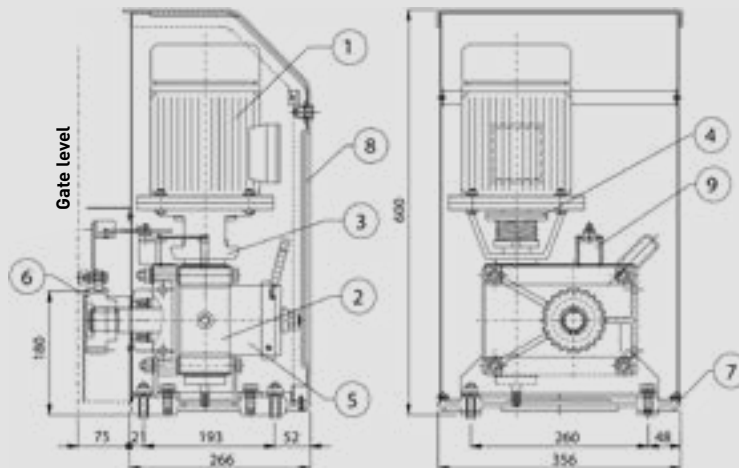



AT 90T / AT 92T

DIMENSIONS

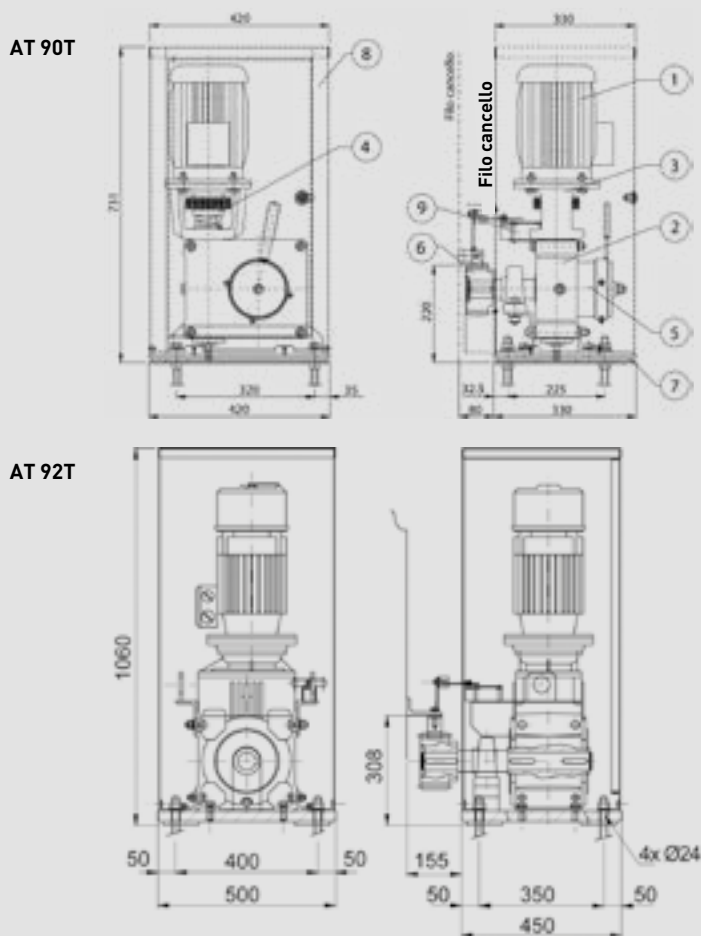

**AT 90T - AT 92T
GEAR MOTOR
MAIN
PRODUCT
ITEMS:**

- 1- Motor
- 2- Worm screw reduction unit
- 3- Bell type coupling
- 4- Single disk dry clutch
- 5- Release device
- 6- Pinion
- 7- Support base
- 8- Door
- 9- Mechanical limit stop

ALZO



OPERATOR DIMENSIONS



Galvanised return pipe with pre-welded bush



Sheet fixing bracket



AT 50



DIMENSIONS

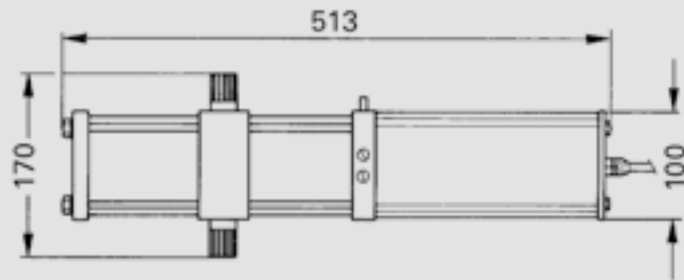

MATIC-BOX 800 / 1200



DIMENSIONS

Dimensions mm		
Width	height	Depth
218	365	125

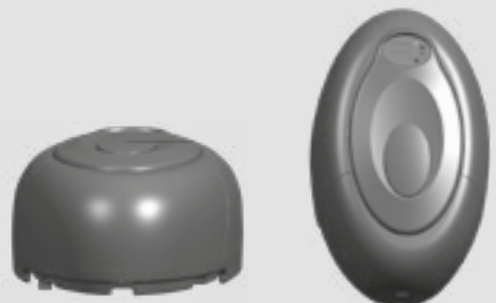
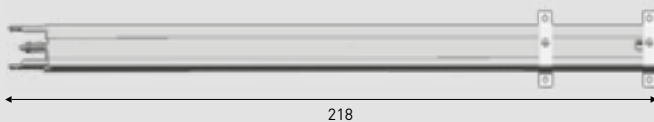



HARRIER 4000R / HARRIER 4000I



DIMENSIONS

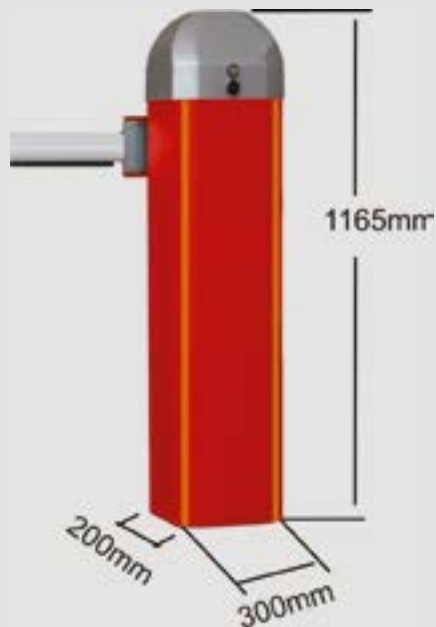

HARRIER 6000I / HARRIER 8000I



DIMENSIONS HARRIER LUX

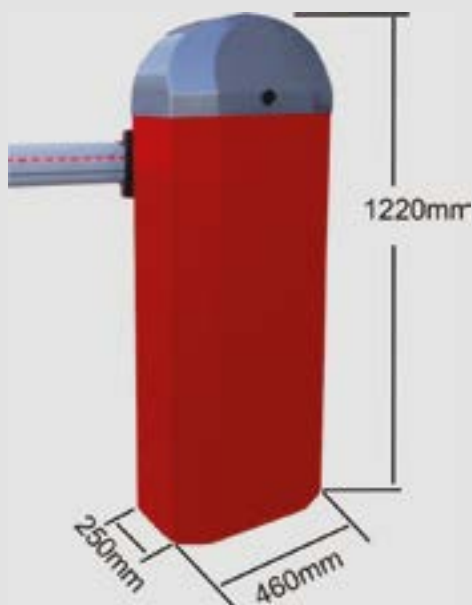



BUONGIORNO

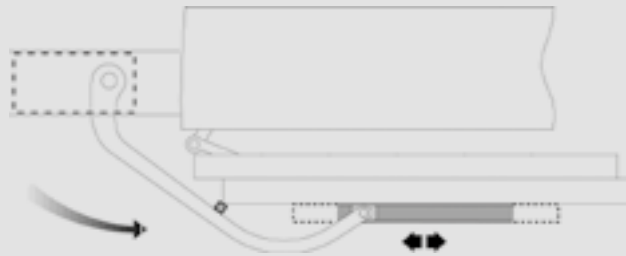
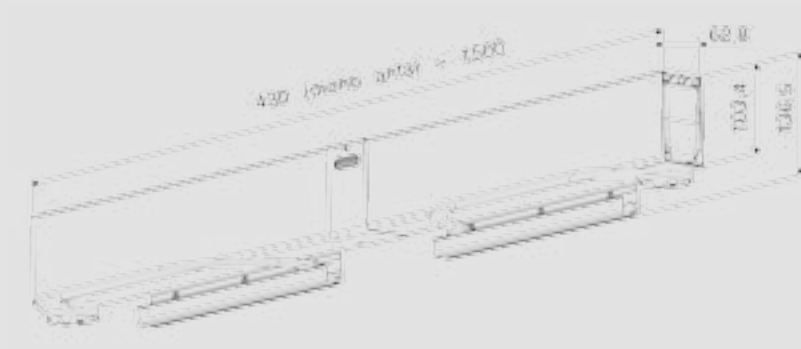

LEVERS

COMPASS LEVER R

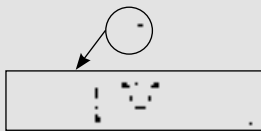

COMPASS LEVER T

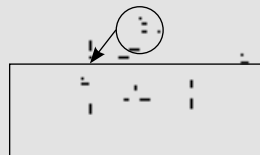

CURVED LEVER WITH AMBIDEXTROUS GUIDE

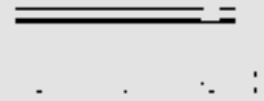

R AND T COMPASS LEVER

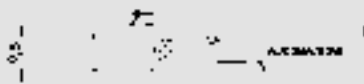

CURVED LEVER WITH AMBIDEXTROUS GUIDE

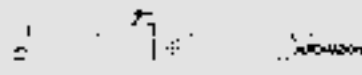



O2M

O2M OUTWARD-OPENING DIMENSIONS

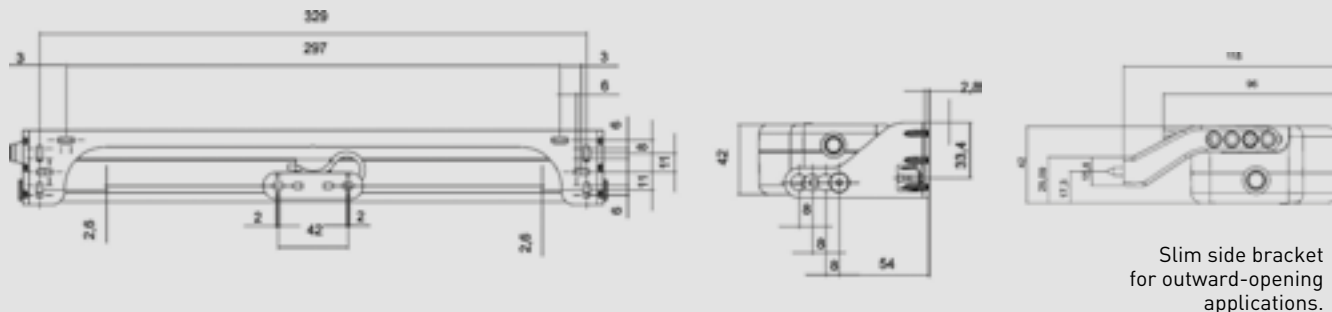

Slim side bracket for outward-opening applications.

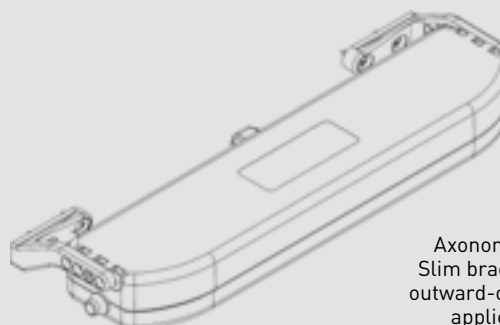

Axonometry of Slim bracket for outward-opening applications.

O2M BOTTOM-HINGED DIMENSIONS

Slim side bracket for bottom-hinged applications.

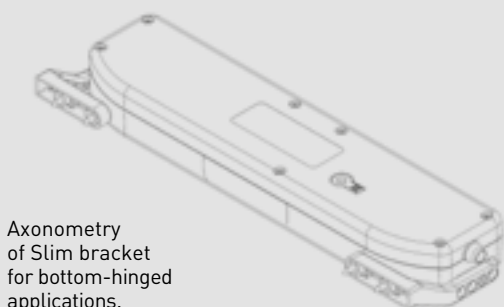
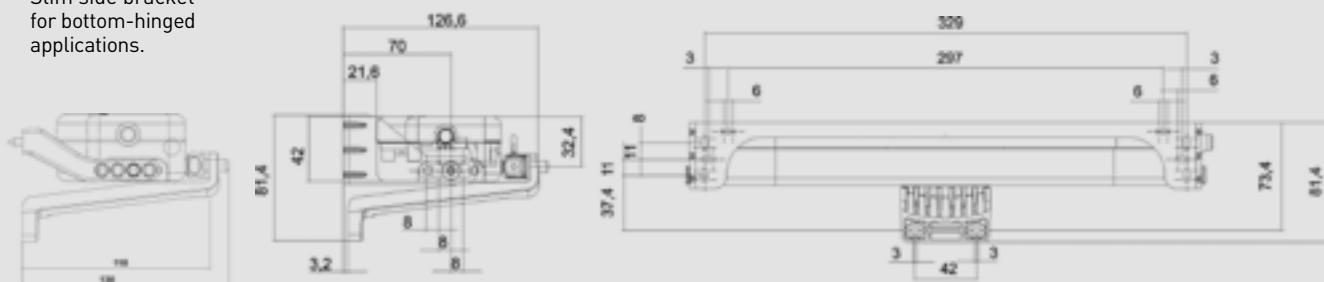

Axonometry of Slim bracket for bottom-hinged applications.

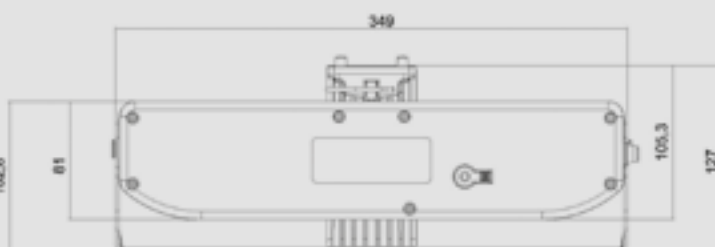



APRICOLOR VARIA



OPERATOR DIMENSIONS

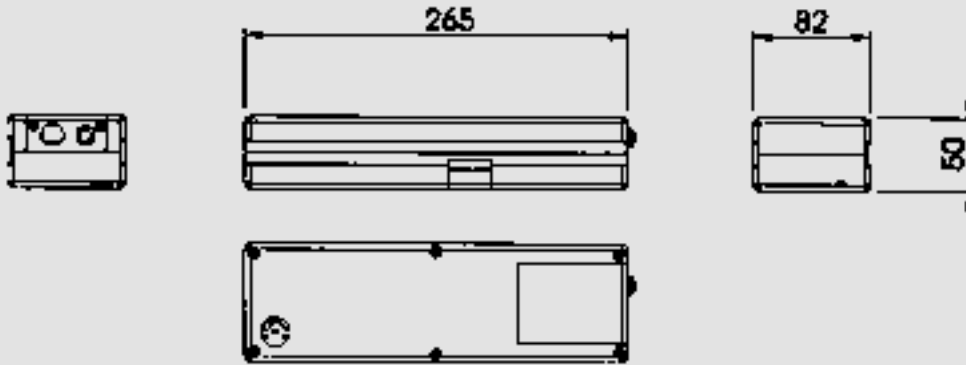

KIT FOR BOTTOM-HINGED APPLICATIONS

VARIA KIT
TRADITIONAL
FIXING SYSTEM



KIT FOR OUTWARD-OPENING APPLICATIONS

VARIA KIT
TRADITIONAL
FIXING SYSTEM

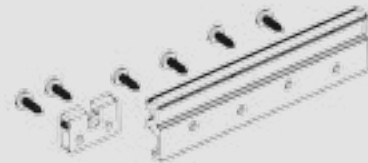



ST 450N

ST450N DIMENSIONS WITH 180MM STROKE

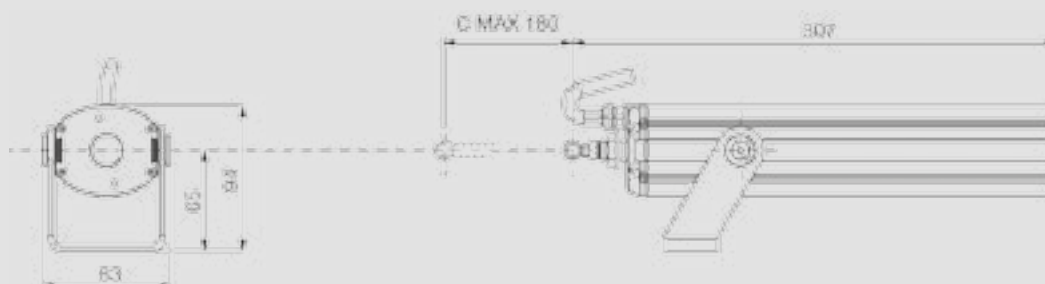

ST450N DIMENSIONS WITH 300MM STROKE

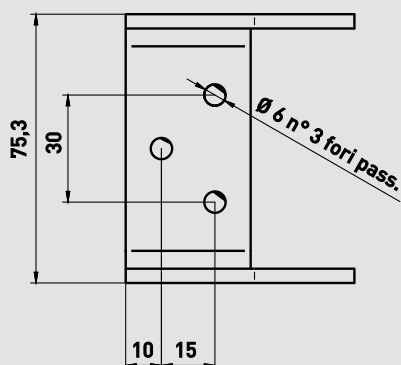
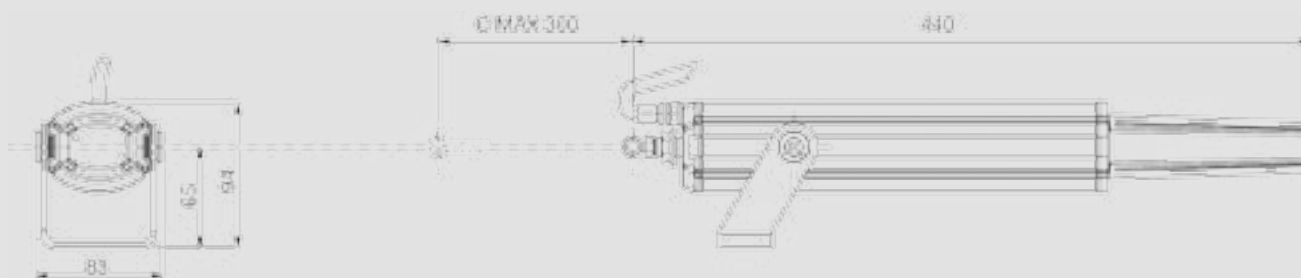



APRILINEARE



APRILINEARE DIMENSIONS

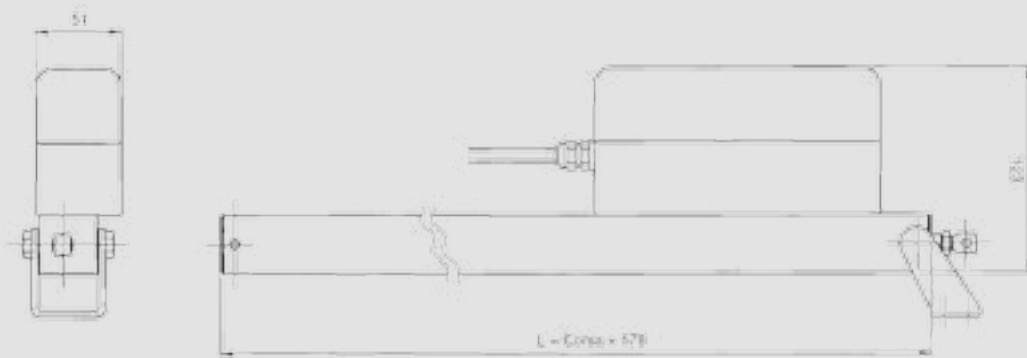

APRILINEARE DUO-TRY SYSTEM



OPERATOR DIMENSIONS

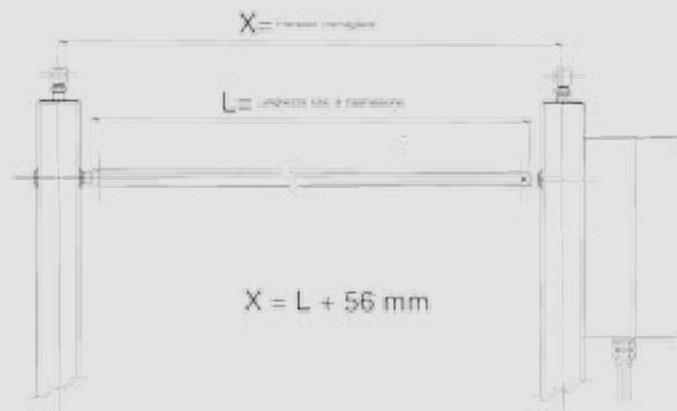



520/600 RF - 520/700 RF



OPERATOR DIMENSIONS

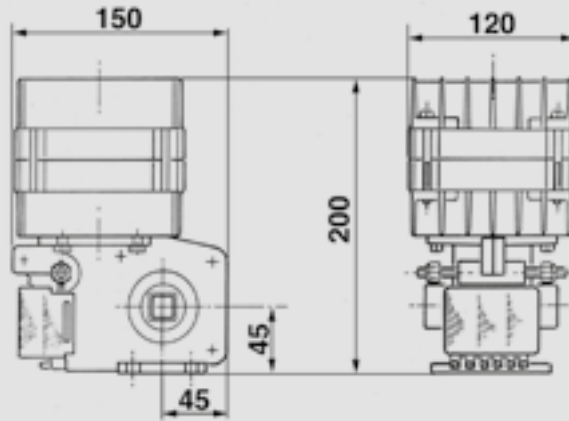

520/600RF MOTOR

- 1- Motor
- 2- Reduction unit
- 3- Planetary reduction unit
- 5- Rotary limit stop
- 6- Terminal with joint

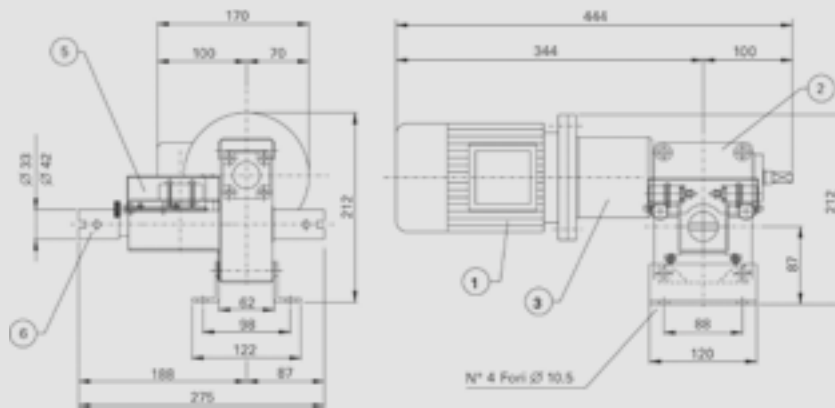

520/700RF MOTOR

- 1- Motor
- 2- Reduction unit
- 4- Pulley gearbox
- 5- Rotary limit stop
- 6- Terminal with joint

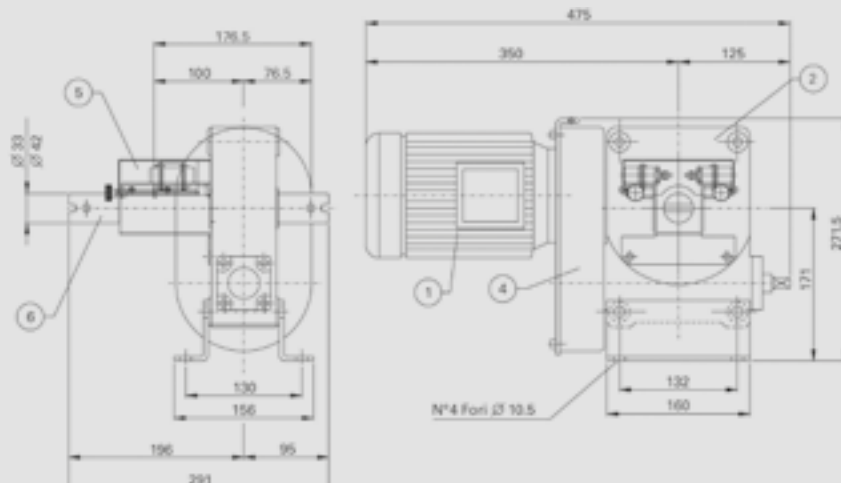



520/600RF - 520/700RF

RACK DIMENSIONS

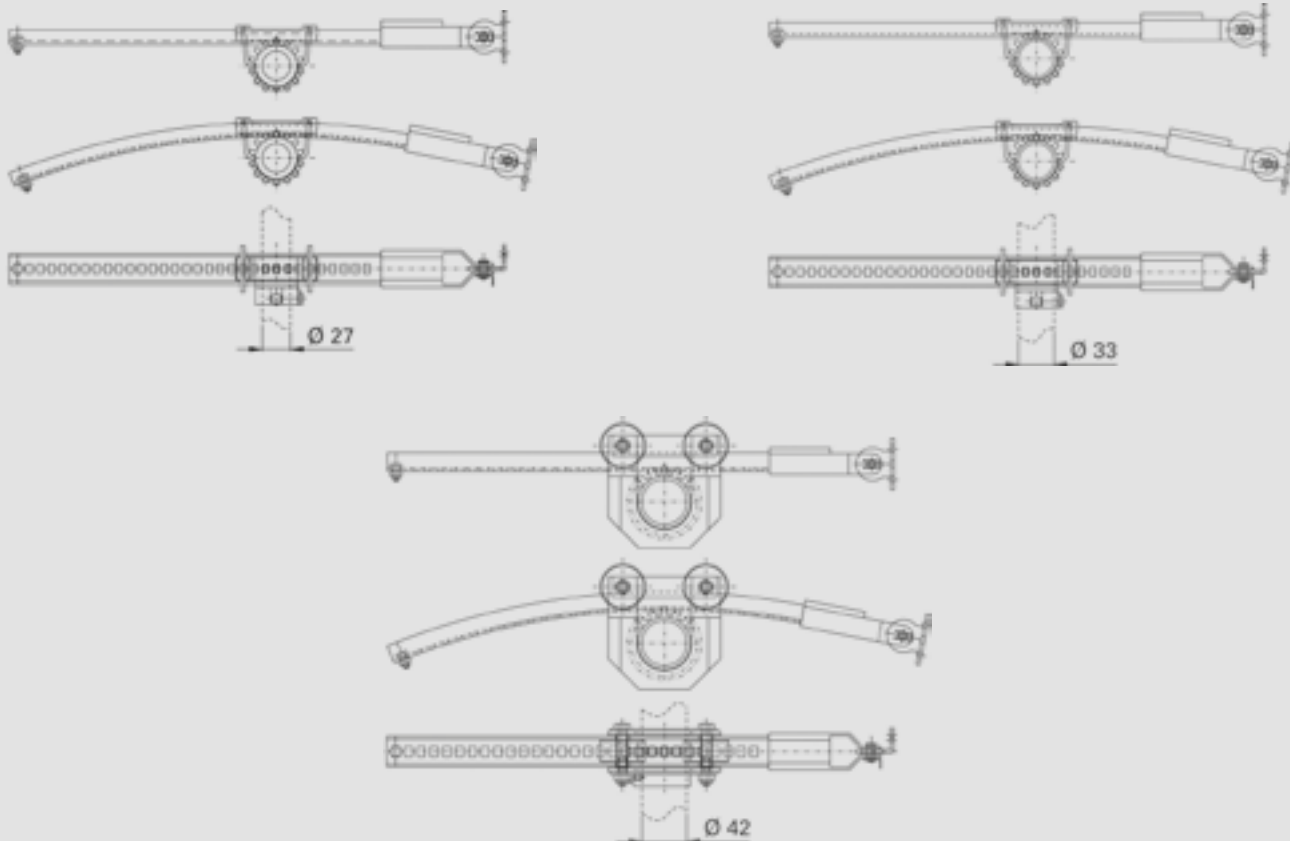

BRACKET AND COUNTER-BRACKET DIMENSIONS

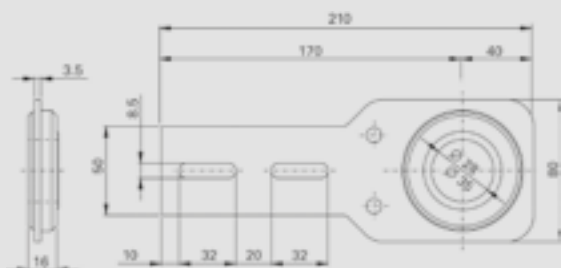

Bracket Ø 27-37 mm

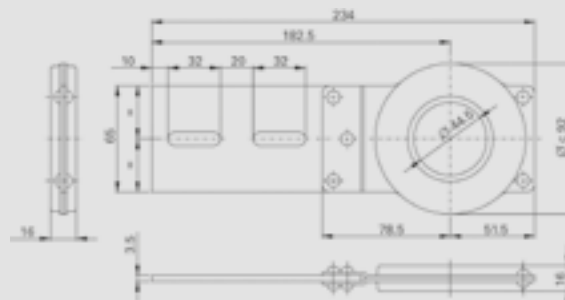

Bracket Ø 42 mm

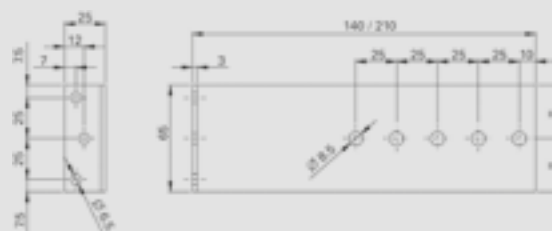

Counter-bracket 140/210 mm



520/600RF - 520/700RF



BOTTOM-HINGED AND OUTWARD-OPENING/PIVOT-HINGED APPLICATION LAYOUTS

APPLICATIONS ON TRANSOM WINDOWS
(rack with pushing compensator)

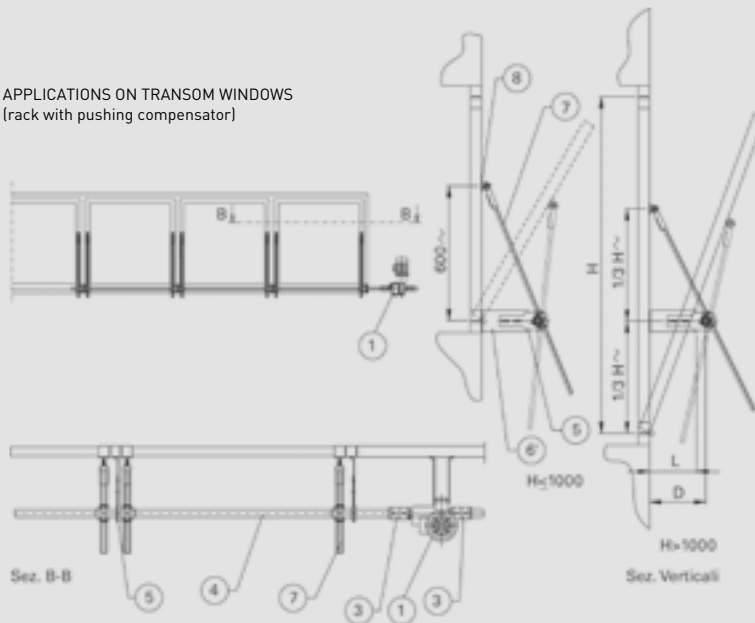

APPLICATIONS ON TOP-HINGED
OR SASH WINDOWS
(racks with pulling compensator)

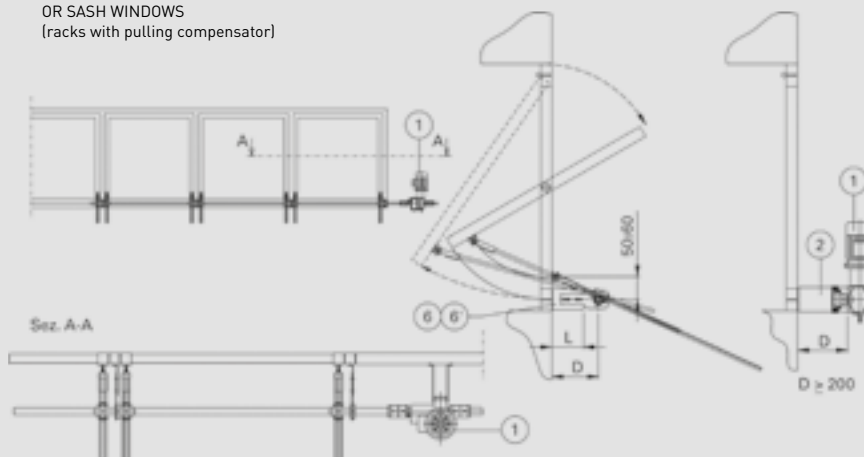

- 1- GEAR MOTOR UNIT WITH LIMIT STOP
- 2- UNIT BRACKETS (not included)
- 3- SHAFT JOINT
- 4- HORIZONTAL SHAFT
- 5- BRACKET

- 6- COUNTER-BRACKET L=140 mm
- 6'- COUNTER-BRACKET L=210 mm
- 7- RACK WITH COMPENSATOR
- 8- FRAME MOUNT



OVER



OPERATOR DIMENSIONS

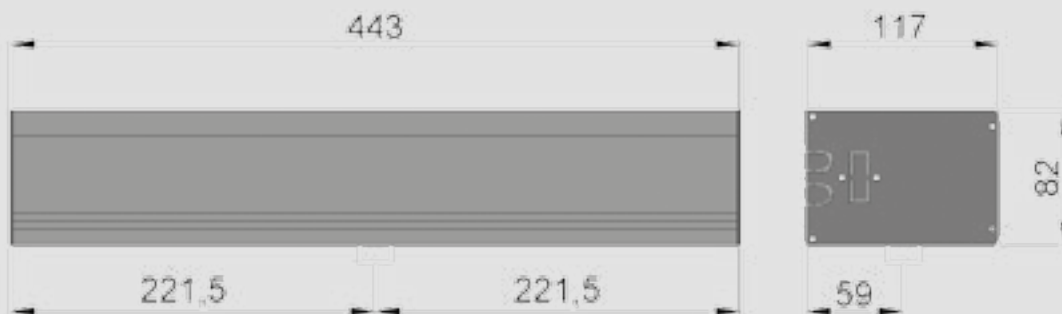

OVER EVO



OPERATOR DIMENSIONS

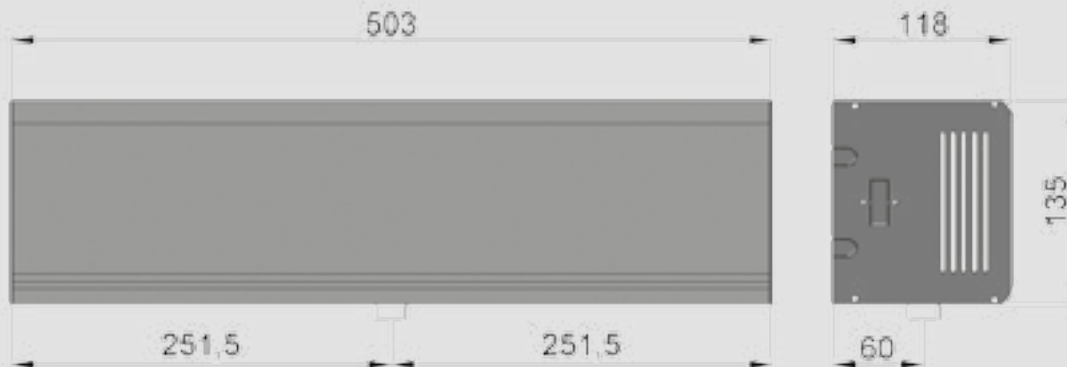



OVER HEAVY



OPERATOR DIMENSIONS

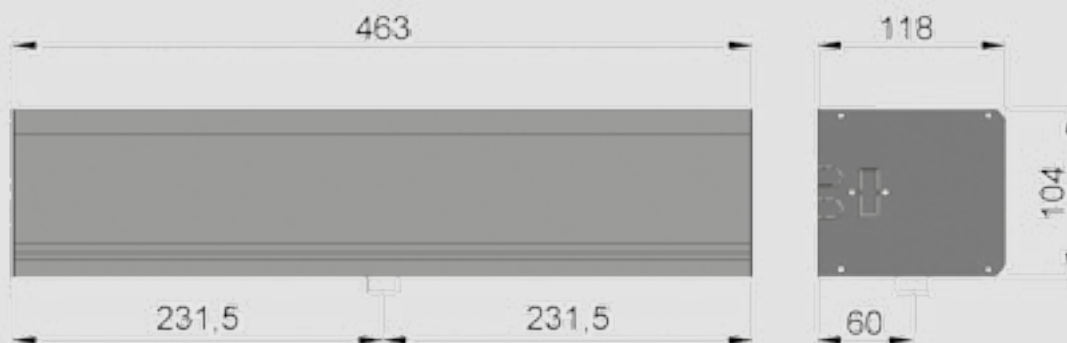

REGULATIONS

We hereby declare that all operators and control units are compliant with the regulations: 2004/108/EC (EMC) directive replacing the previous 89/336/EEC 2006/95/EC (LVD) directive

replacing the previous 73/23/EEC. The Aprimatic Memory System remote controls and receivers in this catalogue have passed the tests set by European regulations: 1999/5/EC directive (R & TTE).

KEY TO PRODUCT VERSIONS

Description of application fields:

- R RESIDENTIAL:** Doors and gates to be motorised typically of limited weight and size, with few daily operations. (E.g., detached/semi-detached houses).
- C CONDOMINIUM:** Doors and gates to be motorised with medium/high frequency of operations per day. (Ex. Medium users, apartments).
- I INDUSTRIAL:** Doors and gates of considerable weight and bulk to be motorised. (Ex. Industrial buildings, car parks).

ADOPTED SYMBOLS

	Motor supply		Protection degree		Information sheet
	Condominium double wing		Memory System		Catalogue page
	Residential double wing		Gate wing weight		
	Condominium sliding		Anti-crushing safety		
	Residential up-and-over		Compliant with EN 12453 standards par. 5.1.1.5 on force limitation		
	Residential single wing		TÜV certification		
	Maximum length per leaf				



SPECIAL SYMBOLS



New item on the catalogue.



Special item.
(please contact the customer service to verify product availability)

Automation systems for swing gates, up-and-over doors and traffic barriers:

- | | |
|---|---|
| <p>A With hydraulic lock valve on opening only, in the closed position the electric lock is required.</p> <p>B With hydraulic lock valve on opening and closing, it does not require any electric lock. In case of electromechanical operator, it indicates the self-locking model.</p> <p>C With hydraulic lock valve on closing only. Does not require the electric lock in closing position.</p> <p>SF Without hydraulic lock valve, when manually pushing the gate/door moves slowly as if it was braked (F). Electric lock required.</p> | <p>SR Similar to the SF model, but when manually pushing the gate/door moves freely. as if it lacked an automation system. Electric lock required.</p> <p>DS Hydraulic operator with hydraulic braking on both closing and opening.</p> <p>RF Hydraulic operator with flow adjustment valve that allows to obtain a linear movement of the gate/door, also with unbalanced load and high initial weight.</p> |
|---|---|

Automation systems for sliding gates:

- Z16** Module 4 16-teeth pinion. Slow. Heavy gates.
- Z20** Module 4 20-teeth pinion. Fast. Light gates.
- C** 16-teeth pinion preset for chain drive.
- E** Electronic control unit on board of the gear motor.

Control devices:

- TR:** Two - or four-channel transmitter. Rolling Code.
- TG:** Two - or four-channel transmitter. Quartz - Dip Switches.



ORDER FORM

SLIM SNK

Name _____ City/Town _____
 Surname _____ Post code _____ Province _____
 Company name _____ ☎ _____ 📱 _____
 Address _____ @ _____

STANDARD AUTOMATION

Code Automation LH single wing Anodized silver	€	Code Automation RH single wing Anodized silver	€	Code Automation Double wing Anodized silver	€	span passage max (mm)	length total automation (mm)
<input type="checkbox"/> 42705/201.1	1.684,88	<input type="checkbox"/> 42705/201.0	1.684,88	<input type="checkbox"/> 42705/201.2	1.800,80	950	2010
<input type="checkbox"/> 42705/251.1	1.748,07	<input type="checkbox"/> 42705/251.0	1.748,07	<input type="checkbox"/> 42705/251.2	1.866,31	1200	2510
<input type="checkbox"/> 42705/301.1	1.822,26	<input type="checkbox"/> 42705/301.0	1.822,26	<input type="checkbox"/> 42705/301.2	1.934,69	1450	3010
<input type="checkbox"/> 42705/361.1	1.894,12	<input type="checkbox"/> 42705/361.0	1.894,12	<input type="checkbox"/> 42705/361.2	2.014,67	1750	3610
<input type="checkbox"/> 42705/401.1	1.947,45	<input type="checkbox"/> 42705/401.0	1.947,45	<input type="checkbox"/> 42705/401.2	2.065,69	1950	4010
<input type="checkbox"/> 42705/441.1	1.999,03	<input type="checkbox"/> 42705/441.0	1.999,03	<input type="checkbox"/> 42705/441.2	2.119,58	2150	4410
<input type="checkbox"/> 42705/481.1	2.052,93	<input type="checkbox"/> 42705/481.0	2.052,93	<input type="checkbox"/> 42705/481.2	2.173,50	2350	4810
<input type="checkbox"/> 42705/541.1	2.132,92	<input type="checkbox"/> 42705/541.0	2.132,92	<input type="checkbox"/> 42705/541.2	2.251,16	2650	5410

Tick the box matching the model and size you wish to order.

Oversized: tick the box by the higher standard length and specify the exact size of the beam ending with zero or five.

<input type="checkbox"/>	<input type="checkbox"/>	<input type="checkbox"/>	<input type="checkbox"/>	<input type="checkbox"/>	mm
--------------------------	--------------------------	--------------------------	--------------------------	--------------------------	----

ACCESSORIES

Q.ty	Code	Control unit	€
<input type="checkbox"/>	42282/070	SC6 - 6-way key-operated selector unit	93,99
<input type="checkbox"/>	42282/073	SC6EC - 6-way key-operated selector unit	118,55
<input type="checkbox"/>	42282/082	Emergency push-button	54,23
Q.ty	Code	Dispositivi di comando	€
<input type="checkbox"/>	42283/090	DT90C double technology safe radar	389,68
<input type="checkbox"/>	42283/091	DM H22 microwave radar	185,85
<input type="checkbox"/>	42283/092	RI90C infrared safe radar	229,95
<input type="checkbox"/>	42283/096	RSI 4C Swing door safety radar	366,45
<input type="checkbox"/>	42283/098	MS20 microwave contactless switch	187,95
Q.ty	Code	Accessories for glass wings	€
<input type="checkbox"/>	42281/061	PCR - clamps for glass doors	252,82
<input type="checkbox"/>	42281/062	Set of fitting for mounting glass wings	112,07
<input type="checkbox"/>	42281/063	Additional reinforcement bracket (1pc)	20,63
<input type="checkbox"/>	42281/064	Plug for glass door clamp (1pc)	13,97
<input type="checkbox"/>	42280/079	GTC - Floor guide set for glass wings	7,60
Q.ty	Code	Mechanical emergency break-out opening device	€
<input type="checkbox"/>	42280/081	Guide and adapter set AMS	76,07
<input type="checkbox"/>	42280/088	1 leaf mech.break out system	338,28
<input type="checkbox"/>	42280/070	Clamp set for semi-fixed door	122,72
<input type="checkbox"/>	42280/076	Magnetic contact smi	10,13
Q.ty	Code	Emergency release systems	€
<input type="checkbox"/>	42280/084	Internal manual release for eb2	66,71
<input type="checkbox"/>	42280/085	External manual release for eb2	129,33
Q.ty	Code	Pre-assembled beam accessories	€
<input type="checkbox"/>	42300/002	ER6/N pre-mtd - photocells pre-mounted for nk series	193,13
<input type="checkbox"/>	42282/077	eb2 nk pre-mtd - electric lock pre-mtd	206,59

COVERS

Length clear (mm)	Code cover natural	€	Code cover silver	€	Code cover black	€
2000	<input type="checkbox"/> 42102/200	107,54	<input type="checkbox"/> 42100/200	123,76	<input type="checkbox"/> 42101/200	145,72
2500	<input type="checkbox"/> 42102/250	120,90	<input type="checkbox"/> 42100/250	144,37	<input type="checkbox"/> 42101/250	166,72
3000	<input type="checkbox"/> 42102/300	135,54	<input type="checkbox"/> 42100/300	158,77	<input type="checkbox"/> 42101/300	190,29
3600	<input type="checkbox"/> 42102/360	162,96	<input type="checkbox"/> 42100/360	190,14	<input type="checkbox"/> 42101/360	213,83
4000	<input type="checkbox"/> 42102/400	175,91	<input type="checkbox"/> 42100/400	199,83	<input type="checkbox"/> 42101/400	232,28
4400	<input type="checkbox"/> 42102/440	190,23	<input type="checkbox"/> 42100/440	213,83	<input type="checkbox"/> 42101/440	256,15
4800	<input type="checkbox"/> 42102/480	209,51	<input type="checkbox"/> 42100/480	248,87	<input type="checkbox"/> 42101/480	285,70
5400	<input type="checkbox"/> 42102/540	228,70	<input type="checkbox"/> 42100/540	254,56	<input type="checkbox"/> 42101/540	313,65

COMPLETE AUTOMATION:

Tick the box matching the model and size you wish to order.

Oversized: tick the box by the higher standard length and specify the exact size of the beam ending with zero or five.

<input type="checkbox"/>	<input type="checkbox"/>	<input type="checkbox"/>	<input type="checkbox"/>	<input type="checkbox"/>	mm
--------------------------	--------------------------	--------------------------	--------------------------	--------------------------	----



ORDER FORM

WING NK

Name _____ City/Town _____
 Surname _____ Post code _____ Province _____
 Company name _____ ☎ _____ 📱 _____
 Address _____ @ _____

STANDARD AUTOMATION

Code Automation LH single wing Anodized silver	€	Code Automation RH single wing Anodized silver	€	Code Automation Double wing Anodized silver	€	Span Passage max. (mm)	Length Total Automation (mm)
<input type="checkbox"/> 42710/201.1	2.091,19	<input type="checkbox"/> 42710/201.0	2.091,19	<input type="checkbox"/> 42710/201.2	2.203,04	950	2010
<input type="checkbox"/> 42710/251.1	2.145,67	<input type="checkbox"/> 42710/251.0	2.145,67	<input type="checkbox"/> 42710/251.2	2.262,76	1200	2510
<input type="checkbox"/> 42710/301.1	2.211,74	<input type="checkbox"/> 42710/301.0	2.211,74	<input type="checkbox"/> 42710/301.2	2.331,14	1450	3010
<input type="checkbox"/> 42710/361.1	2.291,74	<input type="checkbox"/> 42710/361.0	2.291,74	<input type="checkbox"/> 42710/361.2	2.412,29	1750	3610
<input type="checkbox"/> 42710/401.1	2.345,04	<input type="checkbox"/> 42710/401.0	2.345,04	<input type="checkbox"/> 42710/401.2	2.464,45	1950	4010
<input type="checkbox"/> 42710/441.1	2.396,64	<input type="checkbox"/> 42710/441.0	2.396,64	<input type="checkbox"/> 42710/441.2	2.517,19	2150	4410
<input type="checkbox"/> 42710/481.1	2.451,70	<input type="checkbox"/> 42710/481.0	2.451,70	<input type="checkbox"/> 42710/481.2	2.569,94	2350	4810
<input type="checkbox"/> 42710/541.1	2.529,37	<input type="checkbox"/> 42710/541.0	2.529,37	<input type="checkbox"/> 42710/541.2	2.648,76	2650	5410
<input type="checkbox"/> 42710/601.1	2.610,52	<input type="checkbox"/> 42710/601.0	2.610,52	<input type="checkbox"/> 42710/601.2	2.729,91	2950	6010

Tick the box matching the model and size you wish to order.

Oversized: tick the box by the higher standard length and specify the exact size of the beam ending with zero or five.

 mm

ACCESSORIES

Q.ty	Code	Control unit	€
<input type="checkbox"/>	42282/070	SC6 - 6-way key-operated selector unit	93,99
<input type="checkbox"/>	42282/073	SC6EC - 6-way key-operated selector unit	118,55
<input type="checkbox"/>	42282/082	Emergency push-button	54,23
Q.ty	Code	Dispositivi di comando	€
<input type="checkbox"/>	42283/090	DT90C double technology safe radar	389,68
<input type="checkbox"/>	42283/091	DM H22 microwave radar	185,85
<input type="checkbox"/>	42283/092	RI90C infrared safe radar	229,95
<input type="checkbox"/>	42283/096	RSI 4C Swing door safety radar	366,45
<input type="checkbox"/>	42283/098	MS20 microwave contactless switch	187,95
Q.ty	Code	Accessories for glass wings	€
<input type="checkbox"/>	42281/061	PCR - clamps for glass doors	252,82
<input type="checkbox"/>	42281/062	Set of fitting for mounting glass wings	112,07
<input type="checkbox"/>	42281/063	Additional reinforcement bracket (1pc)	20,63
<input type="checkbox"/>	42281/064	Plug for glass door clamp (1pc)	13,97
<input type="checkbox"/>	42280/079	GTC - Floor guide set for glass wings	7,60
Q.ty	Code	Mechanical emergency break-out opening device	€
<input type="checkbox"/>	42280/081	Guide and adapter set AMS	76,07
<input type="checkbox"/>	42280/088	1 leaf mech.break out system	338,28
<input type="checkbox"/>	42280/070	Clamp set for semi-fixed door	122,72
<input type="checkbox"/>	42280/076	Magnetic contact smi	10,13
Q.ty	Code	Emergency release systems	€
<input type="checkbox"/>	42280/084	Internal manual release for eb2	66,71
<input type="checkbox"/>	42280/085	External manual release for eb2	129,33
Q.ty	Code	Pre-assembled beam accessories	€
<input type="checkbox"/>	42300/002	ER6/N pre-mtd - photocells pre-mounted for nk series	193,13
<input type="checkbox"/>	42282/077	eb2 nk pre-mtd - electric lock pre-mtd	206,59

COVERS

Length clear (mm)	Code cover natural	€	Code cover silver	€	Code cover black	€
2000	<input type="checkbox"/> 42102/200	107,54	<input type="checkbox"/> 42100/200	123,76	<input type="checkbox"/> 42101/200	145,72
2500	<input type="checkbox"/> 42102/250	120,90	<input type="checkbox"/> 42100/250	144,37	<input type="checkbox"/> 42101/250	166,72
3000	<input type="checkbox"/> 42102/300	135,54	<input type="checkbox"/> 42100/300	158,77	<input type="checkbox"/> 42101/300	190,29
3600	<input type="checkbox"/> 42102/360	162,96	<input type="checkbox"/> 42100/360	190,14	<input type="checkbox"/> 42101/360	213,83
4000	<input type="checkbox"/> 42102/400	175,91	<input type="checkbox"/> 42100/400	199,83	<input type="checkbox"/> 42101/400	232,28
4400	<input type="checkbox"/> 42102/440	190,23	<input type="checkbox"/> 42100/440	213,83	<input type="checkbox"/> 42101/440	256,15
4800	<input type="checkbox"/> 42102/480	209,51	<input type="checkbox"/> 42100/480	248,87	<input type="checkbox"/> 42101/480	285,70
5400	<input type="checkbox"/> 42102/540	228,70	<input type="checkbox"/> 42100/540	254,56	<input type="checkbox"/> 42101/540	313,65
6000	<input type="checkbox"/> 42102/600	255,27	<input type="checkbox"/> 42100/600	278,10	<input type="checkbox"/> 42101/600	343,14

COMPLETE AUTOMATION:

Tick the box matching the model and size you wish to order.

Oversized: tick the box by the higher standard length and specify the exact size of the beam ending with zero or five.

 mm



ORDER FORM

WING NK H150

Name _____ City/Town _____
 Surname _____ Post code _____ Province _____
 Company name _____ ☎ _____ 📠 _____
 Address _____ @ _____

STANDARD AUTOMATION

Code Automation LH single wing Anodized silver	€	Code Automation RH single wing Anodized silver	€	Code Automation Double wing Anodized silver	€	Span Passage max. (mm)	Length Total Automation (mm)
<input type="checkbox"/> 42715/201.1	2.421,56	<input type="checkbox"/> 42715/201.0	2.421,56	<input type="checkbox"/> 42715/201.2	2.539,80	950	2010
<input type="checkbox"/> 42715/251.1	2.488,80	<input type="checkbox"/> 42715/251.0	2.488,80	<input type="checkbox"/> 42715/251.2	2.606,44	1200	2510
<input type="checkbox"/> 42715/301.1	2.553,12	<input type="checkbox"/> 42715/301.0	2.667,97	<input type="checkbox"/> 42715/301.2	2.673,68	1450	3010
<input type="checkbox"/> 42715/361.1	2.633,11	<input type="checkbox"/> 42715/361.0	2.633,11	<input type="checkbox"/> 42715/361.2	2.752,51	1750	3610
<input type="checkbox"/> 42715/401.1	2.686,43	<input type="checkbox"/> 42715/401.0	2.686,43	<input type="checkbox"/> 42715/401.2	2.805,84	1950	4010
<input type="checkbox"/> 42715/441.1	2.736,86	<input type="checkbox"/> 42715/441.0	2.736,86	<input type="checkbox"/> 42715/441.2	2.858,58	2150	4410
<input type="checkbox"/> 42715/481.1	2.793,09	<input type="checkbox"/> 42715/481.0	2.793,09	<input type="checkbox"/> 42715/481.2	2.900,32	2350	4810
<input type="checkbox"/> 42715/541.1	2.871,90	<input type="checkbox"/> 42715/541.0	2.871,90	<input type="checkbox"/> 42715/541.2	2.977,98	2650	5410
<input type="checkbox"/> 42715/601.1	2.953,05	<input type="checkbox"/> 42715/601.0	2.953,05	<input type="checkbox"/> 42715/601.2	3.070,13	2950	6010

Tick the box matching the model and size you wish to order.

Oversized: tick the box by the higher standard length and specify the exact size of the beam ending with zero or five.

<input type="checkbox"/>	<input type="checkbox"/>	<input type="checkbox"/>	<input type="checkbox"/>	mm
--------------------------	--------------------------	--------------------------	--------------------------	----

ACCESSORIES

Q.ty	Code	Control unit	€
<input type="checkbox"/>	42282/070	SC6 - 6-way key-operated selector unit	93,99
<input type="checkbox"/>	42282/073	SC6EC - 6-way key-operated selector unit	118,55
<input type="checkbox"/>	42282/082	Emergency push-button	54,23
Q.ty	Code	Dispositivi di comando	€
<input type="checkbox"/>	42283/090	DT90C double technology safe radar	389,68
<input type="checkbox"/>	42283/091	DM H22 microwave radar	185,85
<input type="checkbox"/>	42283/092	RI90C infrared safe radar	229,95
<input type="checkbox"/>	42283/096	RSI 4C Swing door safety radar	366,45
<input type="checkbox"/>	42283/098	MS20 microwave contactless switch	187,95
Q.ty	Code	Accessories for glass wings	€
<input type="checkbox"/>	42281/061	PCR - clamps for glass doors	252,82
<input type="checkbox"/>	42281/062	Set of fitting for mounting glass wings	112,07
<input type="checkbox"/>	42281/063	Additional reinforcement bracket (1pc)	20,63
<input type="checkbox"/>	42281/064	Plug for glass door clamp (1pc)	13,97
<input type="checkbox"/>	42280/079	GTC - Floor guide set for glass wings	7,60
Q.ty	Code	Mechanical emergency break-out opening device	€
<input type="checkbox"/>	42280/081	Guide and adapter set AMS	76,07
<input type="checkbox"/>	42280/088	1 leaf mech.break out system	338,28
<input type="checkbox"/>	42280/070	Clamp set for semi-fixed door	122,72
<input type="checkbox"/>	42280/076	Magnetic contact smi	10,13
Q.ty	Code	Emergency release systems	€
<input type="checkbox"/>	42280/084	Internal manual release for eb2	66,71
<input type="checkbox"/>	42280/085	External manual release for eb2	129,33
Q.ty	Code	Pre-assembled beam accessories	€
<input type="checkbox"/>	42300/002	ER6/N pre-mtd - photocells pre-mounted for nk series	193,13
<input type="checkbox"/>	42282/077	eb2 nk pre-mtd - electric lock pre-mtd	206,59

COVERS

Length clear (mm)	Code cover natural	€	Code cover silver	€	Code cover black	€
2000	<input type="checkbox"/> 42102/200	107,54	<input type="checkbox"/> 42100/200	123,76	<input type="checkbox"/> 42101/200	145,72
2500	<input type="checkbox"/> 42102/250	120,90	<input type="checkbox"/> 42100/250	144,37	<input type="checkbox"/> 42101/250	166,72
3000	<input type="checkbox"/> 42102/300	135,54	<input type="checkbox"/> 42100/300	158,77	<input type="checkbox"/> 42101/300	190,29
3600	<input type="checkbox"/> 42102/360	162,96	<input type="checkbox"/> 42100/360	190,14	<input type="checkbox"/> 42101/360	213,83
4000	<input type="checkbox"/> 42102/400	175,91	<input type="checkbox"/> 42100/400	199,83	<input type="checkbox"/> 42101/400	232,28
4400	<input type="checkbox"/> 42102/440	190,23	<input type="checkbox"/> 42100/440	213,83	<input type="checkbox"/> 42101/440	256,15
4800	<input type="checkbox"/> 42102/480	209,51	<input type="checkbox"/> 42100/480	248,87	<input type="checkbox"/> 42101/480	285,70
5400	<input type="checkbox"/> 42102/540	228,70	<input type="checkbox"/> 42100/540	254,56	<input type="checkbox"/> 42101/540	313,65
6000	<input type="checkbox"/> 42102/600	255,27	<input type="checkbox"/> 42100/600	278,10	<input type="checkbox"/> 42101/600	343,14

COMPLETE AUTOMATION:

Tick the box matching the model and size you wish to order.

Oversized: tick the box by the higher standard length and specify the exact size of the beam ending with zero or five.

<input type="checkbox"/>	<input type="checkbox"/>	<input type="checkbox"/>	<input type="checkbox"/>	mm
--------------------------	--------------------------	--------------------------	--------------------------	----



GENERAL SALES CONDITIONS

GENERAL

The general conditions of sale, as reported below, are understood to be valid for any order received by Aprimatic s.r.l. and are an essential part of each order. Any modifications to these clauses, as well as any special conditions, shall be expressly agreed upon in writing. Orders are only supplied in the packaging format indicated on the price list.

ORDERS

Orders acquired by our sale organisation are subject to the approval of Aprimatic s.r.l. Orders should comply with the packing as reported in the price list and their net amount may not be lower than € 150.00.

TRANSPORT

The goods shall travel at the Purchaser's own risk; before collection he/she shall verify, in his/her own interest, the integrity of the packages and the quantity of the goods received. Any complaint shall be made directly to the carrier upon delivery. Delivery EXW Incoterms ICC2000 unless otherwise agreed in writing. All delivery dates given shall be deemed as purely indicative and non-binding. Aprimatic s.r.l. shall not be held responsible to the Purchaser for any failure to perform, including late delivery or failure to deliver, which failure to perform is caused by occurrences beyond Aprimatic's reasonable control or in any case caused by an event of force majeure, including, but not limited to, late delivery of non-delivery of material by suppliers, strikes, and other trade union actions, terrorist activities, suspension of electrical energy or difficulties in transportation.

DELIVERIES

The goods are meant to be delivered ex our factory in Turin or our external warehouses, if the net amount of the order exceeds € 400.00 for EU country and € 600.00 for Extra EU country. For orders less than the net amounts of € 400.00 for EU country will be applied on the amount of order € 40 of transport, and for order less than € 600.00 for extra EU country will be apply on the amount of order € 50 for transport. The terms of delivery are just an indication and have no contractual value.

PRICES

All listed prices are understood to be before VAT. Aprimatic s.r.l., reserves its unquestionable power to modify published list prices if this is required by the cost components of the individual items. The prices indicated on the Price List are not binding. Aprimatic s.r.l. reserves the right to change the price of the Products and/or the discounts, if any, applicable thereto at any time and for any reason, upon 30 (thirty) days' prior written notice to the Purchaser. If any delay in delivery of the Products occurs through the fault of the Purchaser, any possible increase in the price of the Products which may have occurred since the confirmation of the order relating to the Products shall be borne solely by the Purchaser. Any and all taxes, duties, levies, licenses, authorizations, permits and any and all tax and administrative formalities relating to import and/or resale of the Products shall be borne and carried out exclusively by the Purchaser.

RETURNS AND CLAIMS

Any complaints must be sent to Aprimatic s.r.l. in writing within 8 days of receiving of the goods. Returns must be authorised beforehand by Aprimatic s.r.l. Authorized returns must be sent carriage paid to the Aprimatic s.r.l. warehouse with the purchase documents, delivery note and number of authorization enclosed. It will be issued a credit note for the purchase price of the goods minus 20% due to processing fee and testing procedures. Regarding the returns and claims, you can see and downloading the current "conditions" on our website www.aprimatic.com

PRODUCTS

Aprimatic s.r.l. shall be entitled to make minor changes to the Products, without being obliged to inform the Purchaser. The information shown in all Aprimatic publications is provided for information purposes only and is subject to modification at any time without prior warning. Aprimatic s.r.l. does not warrant to the Purchaser that the Products comply with the applicable laws and regulations in force in the country (ies) where the Purchaser is established or where the Products are meant to be sold, delivered and/or installed. Aprimatic shall have no obligation to modify the Products in compliance with said laws or regulations and the Purchaser shall be solely responsible for ensuring that the Products and any service of the Purchaser conform to the applicable technical and safety standards, laws and regulations in force in said country (ies). The Purchaser acknowledges that the Products may be dangerous to persons or property when not installed or used in strict compliance with Aprimatic's written instructions for installation and used furnished by Aprimatic and with the safety requirements specified in the EN 12445 and EN 12543. Aprimatic s.r.l. expressly disclaim liability for any personal injury or property damage resulting from installation or use of the Products, other than in strict compliance with Aprimatic's written instructions with respect to installation and use, or from installation or use of the Products together with

safety accessories or other products not manufactured by Aprimatic, it being understood that the maximum liability of Aprimatic to the Purchaser or to any other person or entity, arising out of or in connection with the Products and based on a claim of breach or under warranty, shall in no case exceed the price paid to Aprimatic for the Products which gives rise to the claim, loss or damage. In no event shall Aprimatic s.r.l. be liable for special and consequential damages, including, without limitation, loss of profit.

PAYMENTS

Payments shall be made to Aprimatic s.r.l. within the agreed term and for the agreed amount. Any delay in the payment of invoices beyond the terms agreed upon triggers the immediate application of bank interest and entails the ensuing suspension of deliveries.

WARRANTIES

Sold goods are guaranteed against manufacturing defects and/or defects of materials for 24 months from the date of installation certified by sending Aprimatic s.r.l., the "Warranty Certificate" for the products provided with it. Exception is made for the products of the Racing Kit line, whose warranty has a 36-month duration from the installation date as certified by sending said certificate. In order for the warranty certificate to be considered valid, it must be sent within 10 days from the date of installation and filled in all its parts. Alternatively, and for the products that are not provided with such a certificate, the warranty shall have a duration of 30 months from the date of production. The warranty terms and conditions are verified by Aprimatic s.r.l. under its final judgment and by the Repair centres it has put in charge of it. The costs of any calling and servicing rights are to the Purchaser's charge. Aprimatic s.r.l. reserves the right not to provide warranty if the powering of the plant is not entirely realised with APRIMATIC products and the installation is not made up to standard. The warranty shall not be in force when operation defects depend on structural flaws, i.e. incompatibility, of the frames to be powered with APRIMATIC products.

The material recognised in warranty shall be accepted for repair only if shipped free port; after the repair or replacement it shall be shipped back freight forward. The replaced material shall remain property of APRIMATIC. The warranty does not include:

- Breakdown or damages caused by transport.
- Breakdown or damages caused by faults in the electrical system and/or carelessness, negligence in using plant and in any case of misuse.
- Breakdown or damages due to tampering or any negligent behaviours or behaviours not conforming with standards by the installer or purchaser without conforming to instructions provided by the manufacturer.
- Breakdown or damages due to use of non-original spare parts.
- Defects caused by chemical agents or atmospheric conditions.
- Consumables.
- Interventions for supposed faults or convenient verifications.

Aprimatic s.r.l. guarantees exclusively the conformity of the Products to the technical specifications submitted to Buyer and published on the web site www.aprimatic.com, provided that the Products have been correctly transported, stored, installed, used and repaired by Buyer (including in compliance with the Aprimatic's manual); in case of defects, purchaser shall write a "reserve" on the delivery note and give a detailed notice thereof in writing to Aprimatic within 7 days from delivery or from discovery, in case of hidden defects and anyhow not later than two years from delivery and Aprimatic shall only be bound to, at its own choice: replace the defective Products or, totally or partially, reimburse their price. Apart from what set forth herewith, Aprimatic shall bear no other responsibility, in particular any liability for damages (including loss of profit or any other subsequent loss) here by expressly excluded.

OWNERSHIP OF GOODS

Aprimatic s.r.l. remains the owner of the goods until their complete payment by the customer. If the seller does not intend to repossess goods for which payment has not been made in full, the seller shall have the right to apply interest charges at a rate of 5% more than the current discount rate.

GENERAL RECOMMENDATIONS

This price list cancels and replaces all previous price lists. In accordance with current safety standards, it is essential to install genuine APRIMATIC control units and accessories. Aprimatic s.r.l. declines all responsibility for injury or damage, even to third parties, deriving from failure to observe these safety standards or from bad craftsmanship in the installation or operation of the goods.

COMPETENT COURT

For any dispute that might arise, the competent court is understood to be the Court of Turin, Italy.

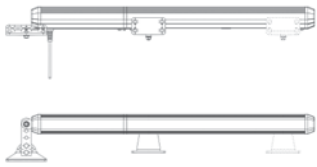
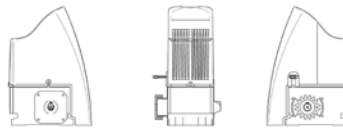
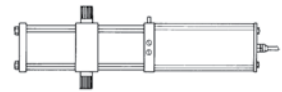
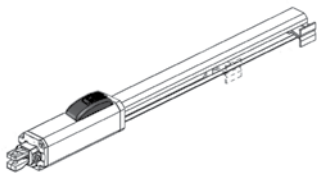
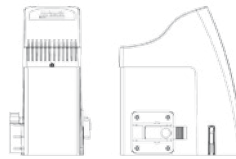
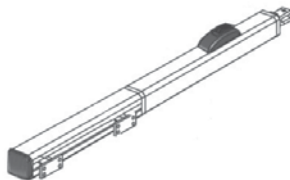
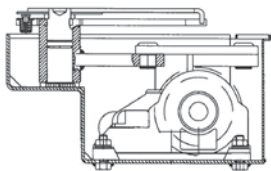
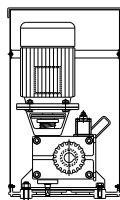
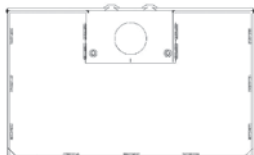
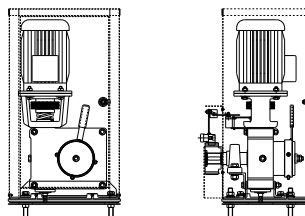
EXTERNAL CLOSING SYSTEM**RAIDER 2500****PAG. 36****SWING GATES****ONDA 424 / 624 / 623****DA PAG. 62****SLIDING GATES****ALZO****PAG. 84****UP-AND-OVER,
SECTIONAL,
FOLDING DOORS****FLEXI 300****PAG. 42****SWING GATES****ONDA 800 / 801****PAG. 68****SLIDING GATES****AT 50****PAG. 86****UP-AND-OVER,
SECTIONAL,
FOLDING DOORS****TWENTY 270****PAG. 44****SWING GATES****AT 80E****PAG. 70****SLIDING GATES****MATIC-BOX 800 / 1200****PAG. 88****UP-AND-OVER,
SECTIONAL,
FOLDING DOORS****FORTY 270 / 390****PAG. 46****SWING GATES****ONDA 2000 / 2001****PAG. 72****SLIDING GATES****HARRIER 4000R****PAG. 96****TRAFFIC BARRIERS****EM 73N****PAG. 48****SWING GATES****AT 86T / AT 88T****PAG. 74****SLIDING GATES****HARRIER 4000I****PAG. 98****TRAFFIC BARRIERS****ZT 70****PAG. 50****SWING GATES****AT 90T / AT 92T****PAG. 76****SLIDING GATES****HARRIERE 6000 / 8000I****PAG. 100****TRAFFIC BARRIERS**



DOORS, WINDOWS AND SHUTTERS

SWING GATES

AP350

PAG. 40



WINDOWS AND SHUTTERS

BUONGIORNO

PAG. 144

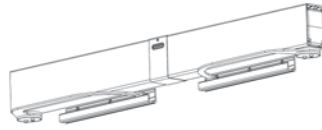

WINDOWS AND DOMES

**APRILINEARE
DUO-TRY SYSTEM**

PAG. 158



SWING GATES

AP423 / 424

PAG. 38



WINDOWS AND DOMES

O2M

PAG. 152

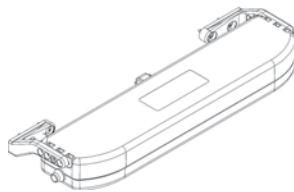

WINDOWS AND DOMES

520 / 600 RF - 520 / 700 RF

PAG. 162

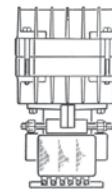

WINDOWS AND DOMES

APRICOLOR VARIA

PAG. 154

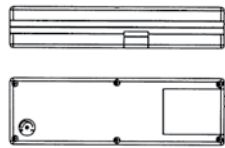

WINDOWS AND DOMES

520 / 600 RF - 520 / 700 RF

PAG. 160

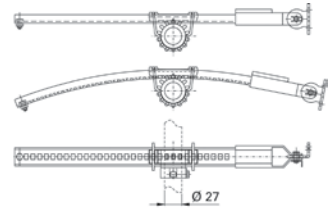

WINDOWS AND DOMES

ST 450N

PAG. 156

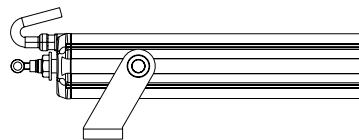

WINDOWS AND DOMES

520 / 600 RF - 520 / 700 RF

PAG. 160

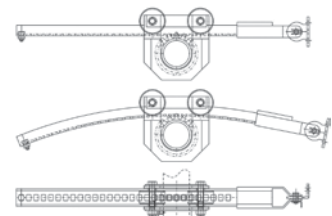

Aprimatic is a registered trademark belonging to Aprimatic s.r.l.

All Aprimatic product bear the mark 

Aprimatic s.r.l. reserves the right to make changes
to its products at any time without prior notice.

www.aprimatic.com | info@aprimatic.it

APR_CG_0716_ENG

