

59140 Miniature Flange Mount Sensor + 57140 Actuator



Description

The 59140 is a miniature flange mounting reed sensor occupying only 3.22cm² (0.500"²) board space with a choice of normally open, normally open high voltage, normally closed or changeover contacts. It's case design enables screw or adhesive mounting and the wires exit from top right hand side. It is also available with left hand exit - see 59141 Series. It is capable of switching up to 265Vac/300Vdc at 10VA. The 59140 functions best with the matching actuator 57140-000.

Note: The 57140 Actuator is sold separately.

Agency Approvals

Agency	Agency File Number
	E61760

Note: Contact Littelfuse for specific agency approval ratings.

Dimensions

Dimensions in mm (inch)

Actuator

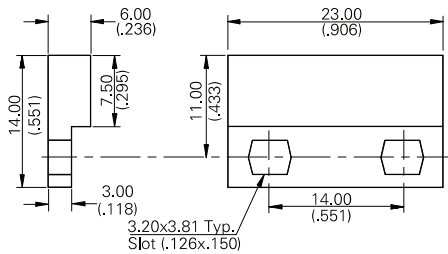

Sensor (Two-wire version)

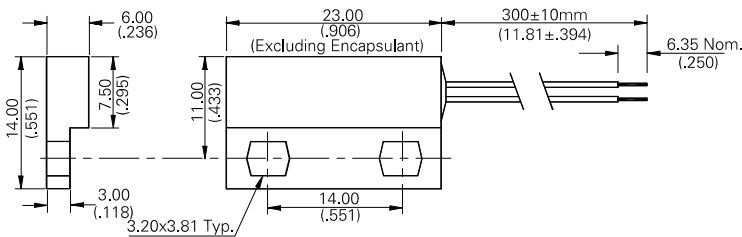

Schematics	Switch Type
	1 and 2
	3
	4

Features

- Magnetically operated position sensor
- Choice of cable length and connector
- Customer defined sensitivity option

Benefits

- Hermetically sealed, magnetically operated contacts continue to operate long after optical and other technologies fail due to contamination
- Operates through non-ferrous materials such as wood, plastic or aluminium
- Excellent for switching micro-controller logic level loads
- No standby power requirement

Applications

- Position and limit sensing
- Security system switch
- Linear actuators
- Door switch

59140 Miniature Flange Mount Sensor + 57140 Actuator

Electrical Ratings

Contact Type			Normally Open	Normally Open High Voltage	Change Over	Normally Closed
Switch Type			1	2	3	4
Contact Rating ¹		VA/Watt - max.	10	10	5	5
Voltage ⁴	Switching ²	Vdc - max.	200	300	175	175
	Breakdown ³	Vac - max.	140	265	120	120
Current ⁴	Switching ²	Vdc - min.	250	400	200	200
		Adc - max.	0.5	.40	0.25	0.25
	Carry	Aac - max.	0.35	0.30	0.18	0.18
Resistance ⁵	Contact, Initial Insulation	Adc - max.	1.2	1.4	1.5	1.5
		Ω - max.	0.2	0.2	0.2	0.2
Capacitance	Contact	Ω - min.	10 ¹⁰	10 ¹⁰	10 ⁹	10 ⁹
		pF - typ.	0.3	0.2	0.3	0.3
Temperature	Operating	°C	-40 to +105	-20 to +105	-40 to +105	-40 to +105

Product Characteristics

Operate Time ⁶		ms - max.	1.0	1.0	3.0	3.0
Release Time ⁶		ms - max.	1.0	1.0	3.0	3.0
Shock ⁷	11ms ½ sine	G - max.	100	100	50	50
Vibration ⁷	50-2000 Hz	G - max.	30	30	30	30

Notes:

- Contact rating - Product of the switching voltage and current should never exceed the wattage rating. Contact Littelfuse for additional load/life information.
- When switching inductive and/or capacitive loads, the effects of transient voltages and/or currents should be considered. Refer to Application Notes AN108A and AN107 for details.
- Breakdown Voltage - per MIL-STD-202, Method 301.
- Electrical Load Life Expectancy - Contact Littelfuse with voltage, current values along with type of load.
- This resistance value is for 11.81mm wire length. Resistance changes when wire lengthens.
- Operate (including bounce)/Release Time - per EIA/NARM RS-421-A, diode suppressed coil (Coil II).
- Shock and Vibration - per EIA/NARM RS-421-A and MIL-STD-202.
- For custom modifications to the wire length or size, or adding a special connector, please contact Littelfuse.

Sensitivity Options (Using 57140 Actuator)

Select Option		S		T		U		V	
Switch Type	Pull-In AT Range	Activate Distance mm (inch) Average	Pull-In AT Range	Activate Distance mm (inch) Average	Pull-In AT Range	Activate Distance mm (inch) Average	Pull-In AT Range	Activate Distance mm (inch) Average	
1	Normally Open	12-18	10.4 (.410)	17-23	8.4 (.330)	22-28	7.2 (.283)	27-33	6.3 (.248)
2	High Voltage	—	—	17-23	8.4 (.330)	22-28	7.2 (.283)	27-33	6.3 (.248)
3	Change Over	15-20	11.6 (.457)	20-25	10.6 (.417)	25-30	10.0 (.394)	—	—
4	Normally Closed	15-20	11.6 (.457)	20-25	10.6 (.417)	25-30	10.0 (.394)	—	—

Note:

- Pull-In AT Range: These AT values are the bare reed switch AT before modification.
- The activation distance is average value on the final sensor assembly.

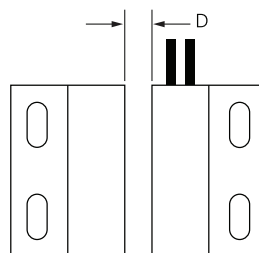

59140 Miniature Flange Mount Sensor + 57140 Actuator



Cable Length Specification

Cable Type: 24 AWG 7/32 PVC 105°C UL1430/UL1569

Select Option	Cable Length mm (inch)
02	300 (11.81)

Termination Specification

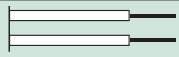
Termination Options

Select Option	Description (Two-wire versions illustrated)	
A	Tinned leads (6.4±0.76)mm	
F	Untinned leads (6.4±0.76)mm	
E	JST type XHP 2.5mm pitch	

Part Numbering System

Sensor: 59140 - X - X - XX - X

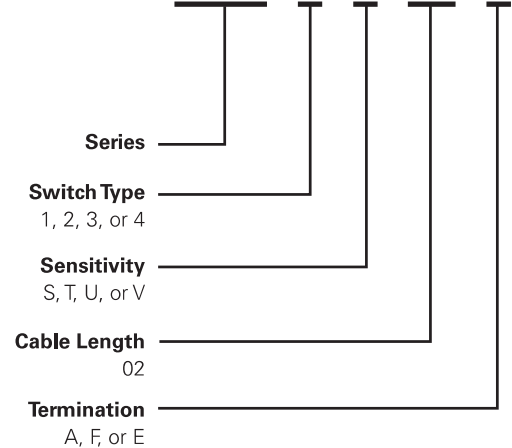

Actuator: 57140 - 000

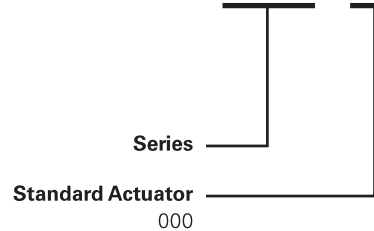

Note: The 57140 Actuator is sold separately.

Packaging

Packaging Option	Packaging Specification	Quantity	Quantity & Packaging Code	Taping Width
Bulk	Bulk	500	N/A	N/A