

# Dynorbital-Spirit® Random Orbital Sander

## NEW! Comfort Platform

Now included on all palm-style Dynorbital-Spirit® Random Orbital Sanders!

- New Comfort Platform provides additional hand and wrist support, further enhancing operator comfort. Also offers increased protection against cold air exhaust.

Order 59330 Comfort Platform separately, to install on existing tools!

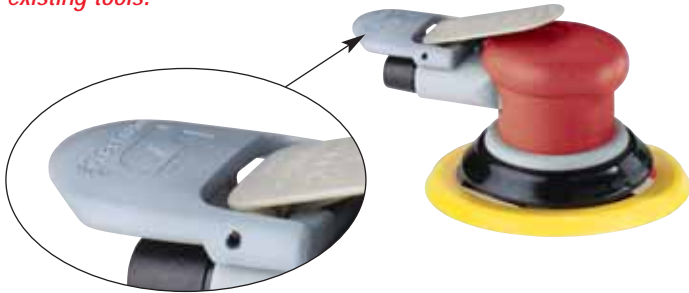

## Color-Coded Levers

- Quickly identify three different orbits which correctly matches the right tool for the right job.

### BLACK

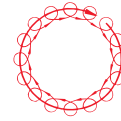

- 3/32" Diameter Orbit for ultra-fine sanding. (500+ Grit generally)

### GREY

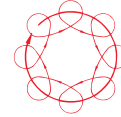

- 3/16" Diameter Orbit for general sanding. (120 - 400 Grit generally)

### BLUE

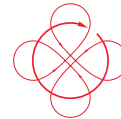

- 3/8" Diameter Orbit for aggressive sanding. (Under 120 Grit generally)

## REPLACEMENT DROP-IN MOTOR

Quick in-house repair lessens downtime. Average repair time now less than five minutes, with proper tools. (For replacement motors, see page 36).

## ERGONOMIC GRIP

The shape of the housing conforms to operator's hand for proper wrist position required for greater comfort and control.

**PATENTED**  
U.S. Patents  
4,854,085 &  
6,878,049

## COMPOSITE LEVER

Insulates cold. When the palm-conformed lever is activated, it becomes recessed into the housing thus eliminating a "pinch point" on the sensitive area of the palm.

## LESS VIBRATION

Composite base has integrated full-rubber over-mold creating a non-slip insulated feel.

## PERFECTLY BALANCED PAD

*The Best in the Industry!*  
Perfectly-balanced weight-mated pad: the ultimate in swirl-free finishes!

3-1/2" – 80 grams  
5" – 100 grams  
6" – 130 grams

## DOUBLE ROW BALANCER BEARING

Innovative bearing seals protect high-quality bearings from sanding residue and reduce bearing temperature for longer bearing life.

## CUSTOM-ENGINEERED CYLINDER

Custom-engineered, high-strength cylinder provides longer life for less maintenance.

## LOW SOUND LEVELS

Muffling system reduces sound levels to as low as 75 dB(A). Easy to replace muffler inserts.

## ONE-PIECE SPEED CONTROL DIAL

Standard on all models. Adjustable side dial maintains user desired speed: variable 4,000 - 12,000 RPM.

## LIP-SEAL SHROUD

Correct spacing between shroud and pad allows for the most efficient operation of the tool on the work surface. Protects operator from moving sanding pad and enhances dust collection on vacuum models.

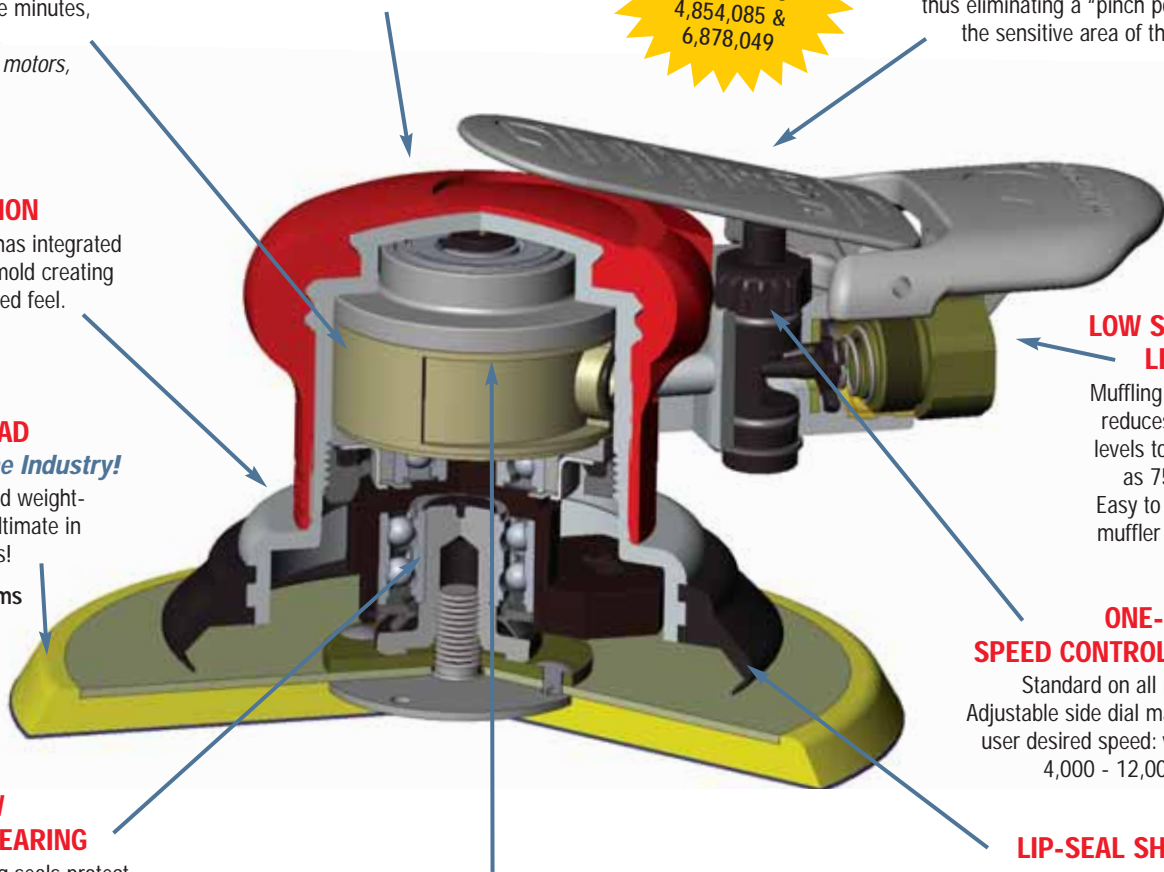

# Dynorbital-Spirit® Models

- All models include our best premium urethane, weight-mated sanding pads for optimum performance.
- Top performance sanders assure quality finishes.
- For Dynorbital-Spirit® accessories, see pages 36 and 51.
- Replacement sanding pads shown on pages 47 and 48.
- Abrasives shown on page 52.

## Non-Vacuum

- May be converted to a vacuum tool with optional kit.

Pad Diameter	3/32" Orbit Models	3/16" Orbit Models	3/8" Orbit Models
3"	21040	21020	21000
3-1/2"	21045	21025	21005
5"	21050	21030	21010
6"	21055	21035	21015
6" w/Hook-Face Pad	21062	21061	21060



## Central Vacuum-Ready

- Ready for hook-up to portable or central vacuum system.
- Vacuum hose and cuffs available – see page 43.

Pad Diameter	3/32" Orbit Models	3/16" Orbit Models	3/8" Orbit Models
3"	21044	21024	21004
3-1/2"	21049	21029	21009
5"	21054	21034	21014
6"	21059	21039	21019
6" w/Hook-Face Pad	21065	21064	21063



## Self-Generated Vacuum

- Tool creates its own vacuum.
- Not for central vac or portable vac systems.

Pad Diameter	3/32" Orbit Models	3/16" Orbit Models	3/8" Orbit Models
3"	21041	21021	21001
3-1/2"	21046	21026	21006
5"	21051	21031	21011
6"	21056	21036	21016



## Also Available

### Model 21067 - 3/16" Orbit

- 6" dia. Self-Generated Basic Vacuum Tool. Includes exhaust hose, air line, hose bands and 5-micron filter bag.

Model Number	Motor hp	Motor RPM	Sound Level	Air Flow Rate CFM/SCFM	Air Pressure PSIG	Air Inlet Thread	Hose Size	Spindle Thread	Weight (Non-Vac/Vac)	Length (Non-Vac/Vac)	Height Inch
All Models	.25	12,000	75 dB(A)	2/14	90	1/4" NPT	1/4"	5/16"-24 female	1.4 to 1.6 lbs.	6" to 9"	3-1/2

# HiVac 3" Dia. Dynorbital-Spirit® Models

- The combination of our unique shroud design and 3-hole sanding pad provide enhanced collection of dust and debris.
- No bulky sanding shroud to get in the way!
- A small tool with big power and vacuum capability.
- 3" diameter pad accepts Hook-Face or Mesh-Style abrasive discs.
- The random orbital action enables operator to achieve swirl-free finishes.
- Comfortable tool weight of only 1.3 lbs. minimizes operator fatigue.

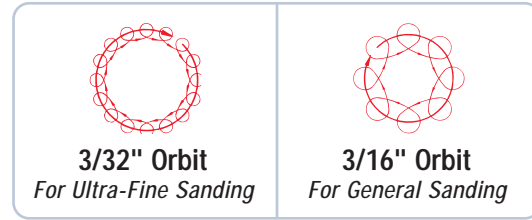

**3/32" Orbit**  
For Ultra-Fine Sanding

**3/16" Orbit**  
For General Sanding

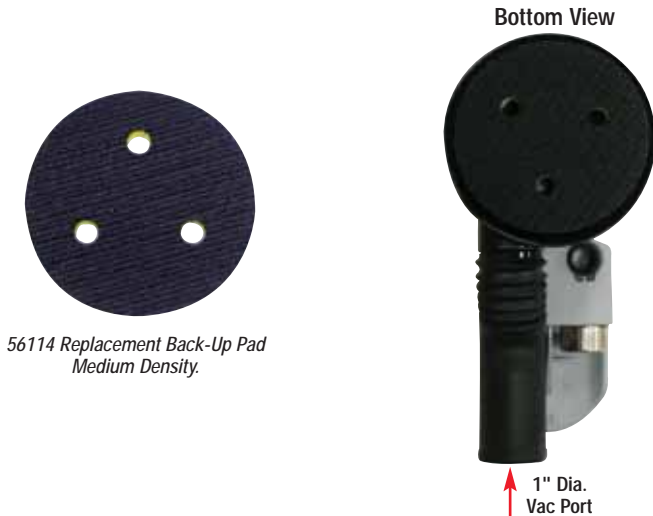

56114 Replacement Back-Up Pad  
Medium Density.

1" Dia.  
Vac Port



Model 21071

Compact shroud allows for maximum sanding and visibility near edges.

## Self-Generated Vacuum

- Self-generated vacuum-ready models are ready for connection to portable dust collection systems (optional).

Orbit Diameter	Model Number
3/32"	21069
3/16"	21068



Model 21069

50617 Dust Collection System must be ordered separately.

## Central Vacuum

- Ready for hook-up to portable vacuum or central vacuum system.
- All models include combination lip seal/overskirt shroud, which offers enhanced vacuum capability and greater workpiece visibility.

Orbit Diameter	Model Number
3/32"	21071
3/16"	21070



Model 21071

Model Number	Motor hp	Motor RPM	Max. Air Flow CFM/SCFM	Hose I.D. Size Inch	Air Inlet Thread	Air Pressure PSIG	Spindle Thread	Weight Pound	Length Inch	Height Inch
21068/21069	.25	12,000	2/14	1/4	1/4" NPT	90	5/16"-24	1	7-3/4	3-3/4
21070/21071	.25	12,000	2/14	1/4	1/4" NPT	90	5/16"-24	1	6-1/2	3-3/4