

SKT 1200/18 E



Capsule Thyristor

Line Thyristor SKT 1200/18 E

Features

- Hermetic metal case with ceramic insulator
- Capsule package for double sided cooling
- Shallow design with single sided cooling
- International standard case
- Off-state and reverse voltages up to 1800 V
- Amplifying gate

Typical Applications*

- DC motor control (e. g. for machine tools)
- Controlled rectifiers (e. g. for battery charging)
- AC controllers (e. g. for temperature control)
- Recommended snubber network e. g. for $V_{VRMS} \leq 400$ V: $R = 33 \Omega / 32$ W, $C = 1 \mu F$

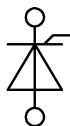

SKT

Absolute Maximum Ratings				
Symbol	Conditions		Values	Unit
Chip				
$I_{T(AV)}$	sinus 180°	$T_c = 85 \text{ °C}$	1200	A
		$T_c = 100 \text{ °C}$	840	A
I_{TSM}	10 ms	$T_j = 25 \text{ °C}$	30000	A
		$T_j = 125 \text{ °C}$	25500	A
i^2t	10 ms	$T_j = 25 \text{ °C}$	4500000	A ² s
		$T_j = 125 \text{ °C}$	3251250	A ² s
V_{RSM}			1800	V
V_{RRM}			1800	V
V_{DRM}			1800	V
$(di/dt)_{cr}$	$T_j = 125 \text{ °C}$		125	A/ μ s
$(dv/dt)_{cr}$	$T_j = 125 \text{ °C}$		1000	V/ μ s
T_j			-40 ... +125	°C
Module				
T_{stg}			-40 ... +130	°C

Characteristics					
Symbol	Conditions	min.	typ.	max.	Unit
Chip					
V_T	$T_j = 25 \text{ °C}$, $I_T = 3600$ A			1.65	V
$V_{T(TO)}$	$T_j = 125 \text{ °C}$			0.95	V
r_T	$T_j = 125 \text{ °C}$			0.18	m Ω
$I_{DD}; I_{RD}$	$T_j = 125 \text{ °C}$, $V_{DD} = V_{DRM}$; $V_{RD} = V_{RRM}$			160	mA
t_{gd}	$T_j = 25 \text{ °C}$, $I_G = 1$ A, $di_G/dt = 1$ A/ μ s		1		μ s
t_{gr}	$V_D = 0.67 \cdot V_{DRM}$		2		μ s
t_q	$T_j = 125 \text{ °C}$	100		250	μ s
I_H	$T_j = 25 \text{ °C}$		250	500	mA
I_L	$T_j = 25 \text{ °C}$, $R_G = 33 \Omega$		500	2000	mA
V_{GT}	$T_j = 25 \text{ °C}$, d.c.	3			V
I_{GT}	$T_j = 25 \text{ °C}$, d.c.	250			mA
V_{GD}	$T_j = 125 \text{ °C}$, d.c.			0.25	V
I_{GD}	$T_j = 125 \text{ °C}$, d.c.			10	mA
$R_{th(j-c)}$	continuous DC	SSC			K/W
		DSC		0.021	K/W
$R_{th(j-c)}$	sin. 180°	SSC		0.054	K/W
		DSC		0.0225	K/W
$R_{th(j-c)}$	rec. 120°	SSC		0.06	K/W
		DSC		0.027	K/W
Module					
$R_{th(c-s)}$	SSC		0.01		K/W
	DSC		0.005		K/W
F		22		25	KN
a					m/s ²
w			480		g

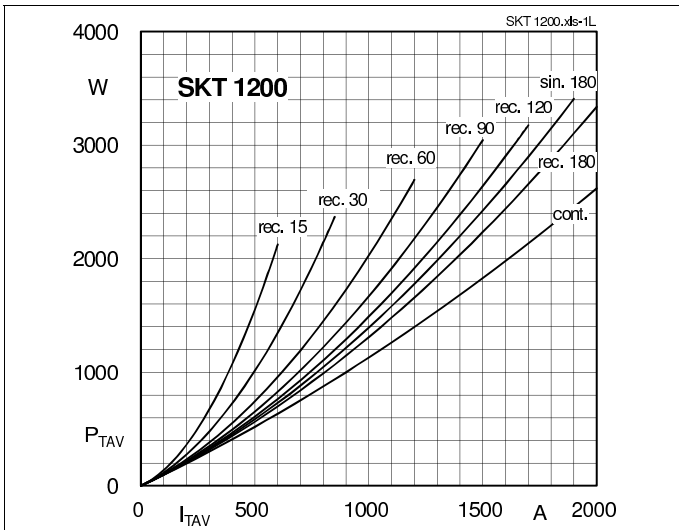

Fig. 1L: Power dissipation vs. on-state current

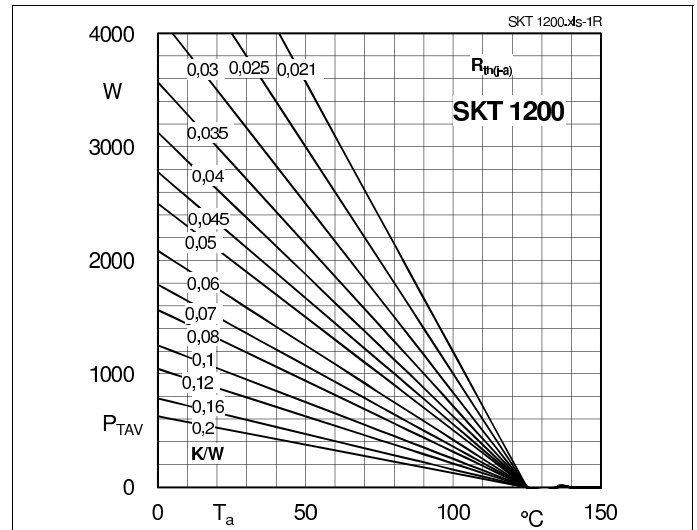

Fig. 1R: Power dissipation vs. ambient temperature

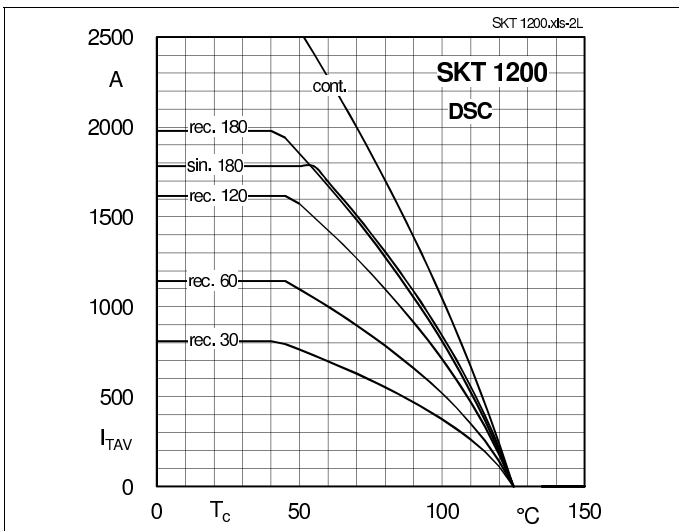

Fig. 2L: Rated on-state current vs. case temperature

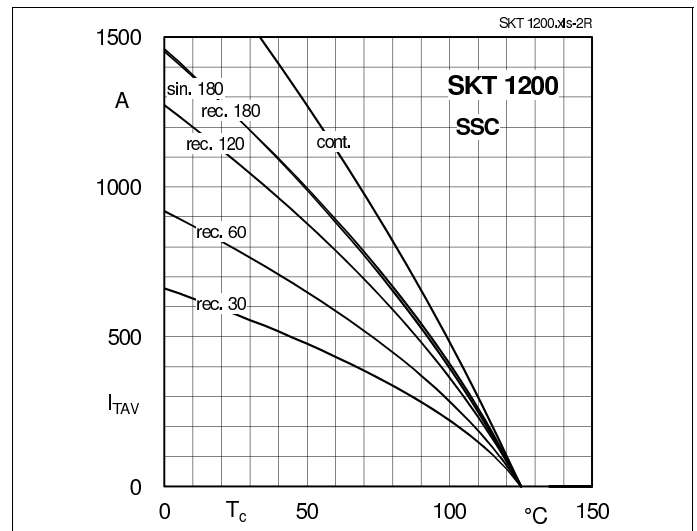

Fig. 2R: Rated on-state current vs. case temperature

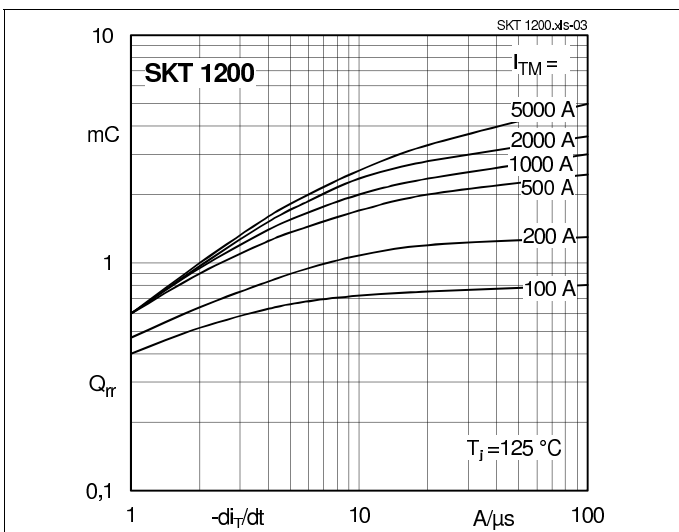

Fig. 3: Recovered charge vs. current decrease

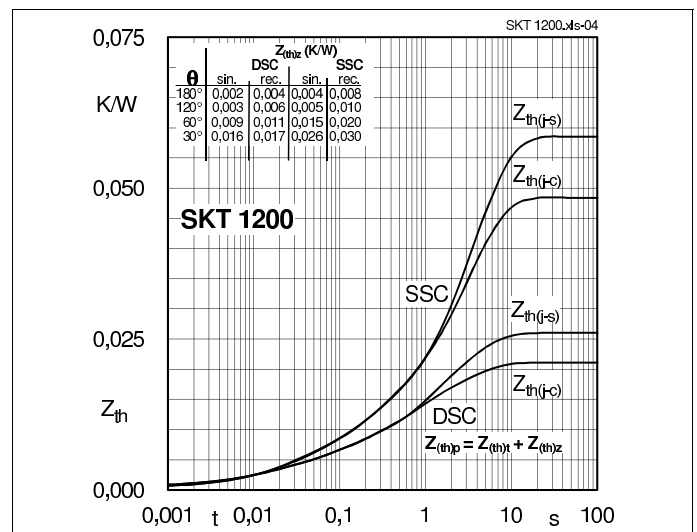

Fig. 4: Transient thermal impedance vs. time

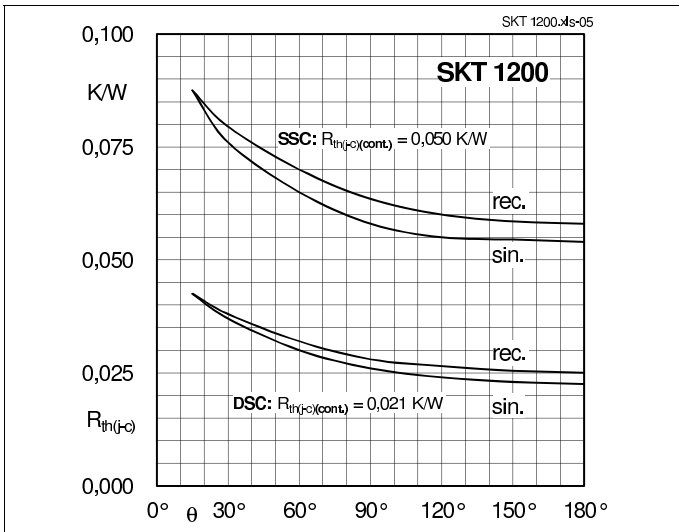

Fig. 5: Thermal resistance vs. conduction angle

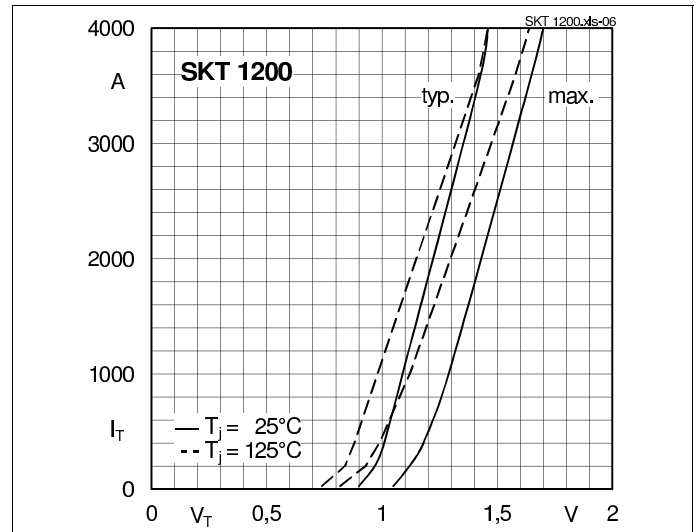

Fig. 6: On-state characteristics

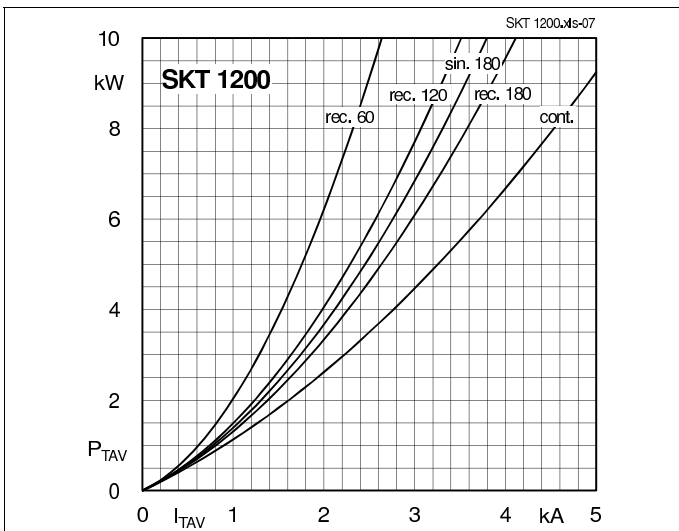

Fig. 7: Power dissipation vs. on-state current

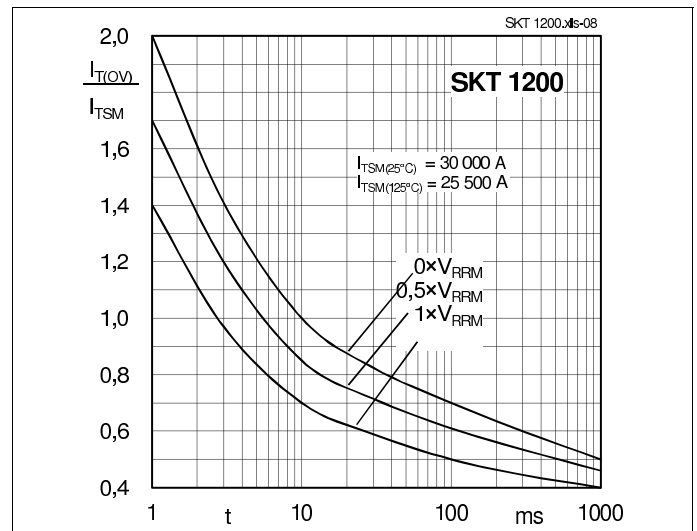

Fig. 8: Surge overload current vs. time

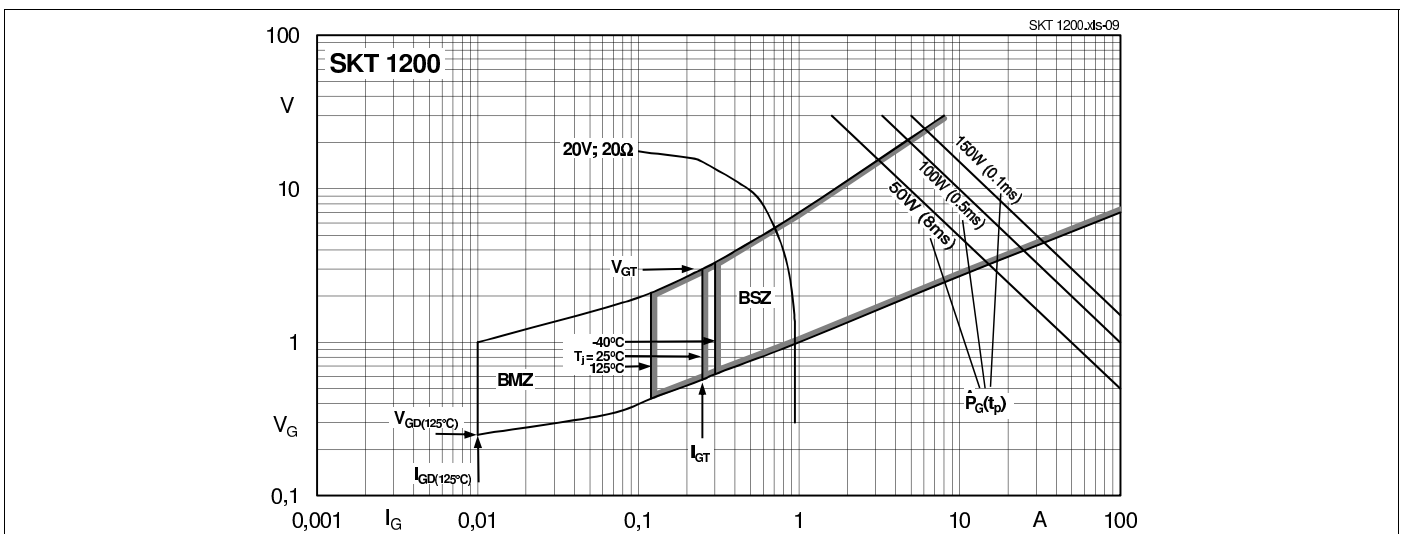
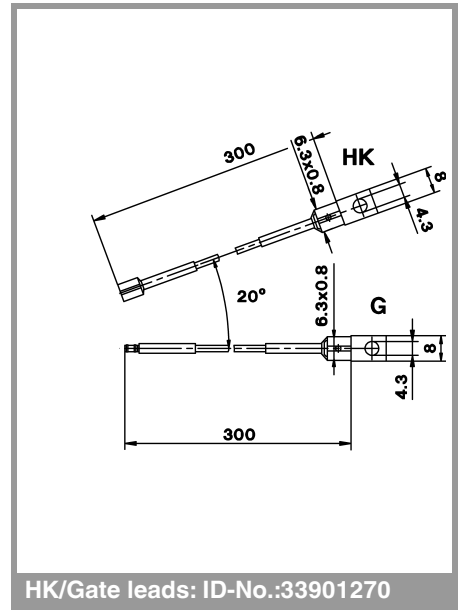
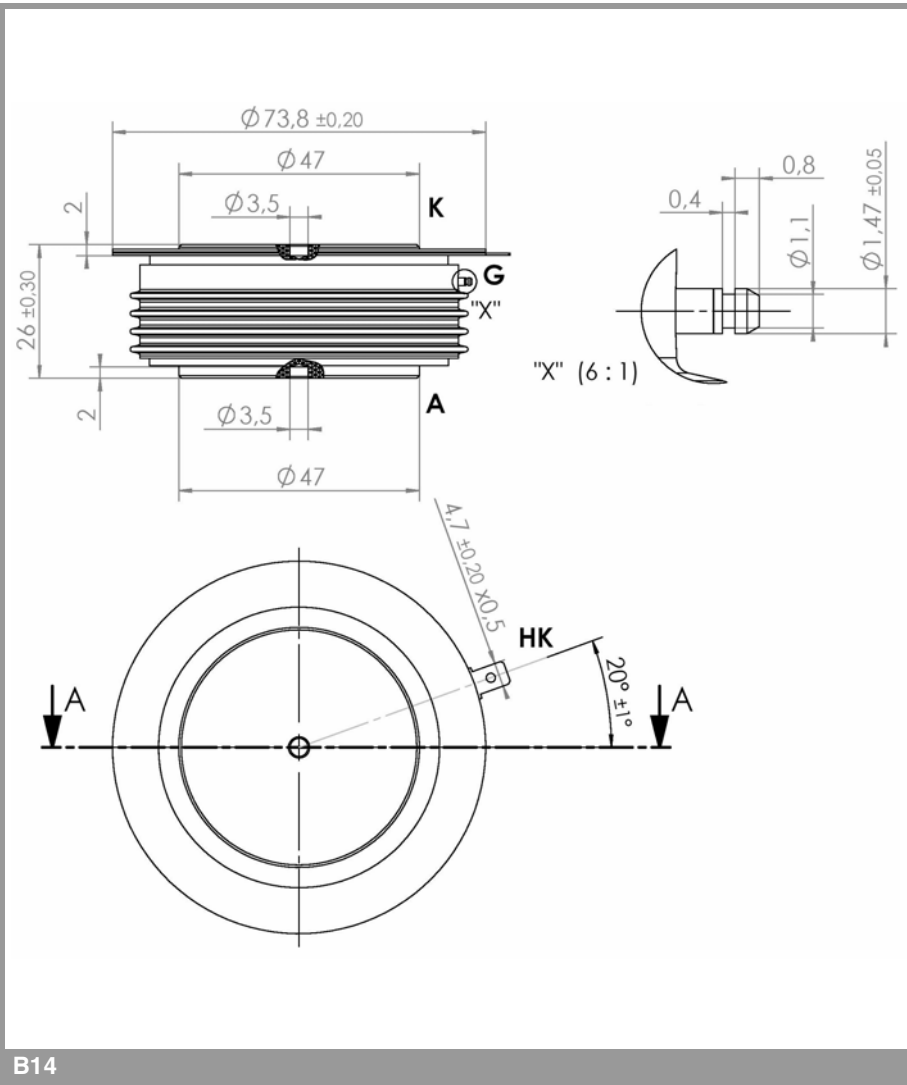

Fig. 9: Gate trigger characteristics

SKT 1200/18 E



HK/Gate leads: ID-No.:33901270

B14

This is an electrostatic discharge sensitive device (ESDS), international standard IEC 60747-1, Chapter IX

* The specifications of our components may not be considered as an assurance of component characteristics. Components have to be tested for the respective application. Adjustments may be necessary. The use of SEMIKRON products in life support appliances and systems is subject to prior specification and written approval by SEMIKRON. We therefore strongly recommend prior consultation of our staff.