

## Vitreous Wirewound Resistors acc. MIL-PRF-26



The RW series, with completely welded construction, is the perfect choice for high continuous power dissipation up to 480 W with the option for adjustable (RW E) and non-inductive types (RW Ni). The components of this series are well suited for harsh environments and exhibit a long lifetime. With their high pulse power capabilities and high operating voltages, they are an ideal choice for inrush limiters. Typical applications include but are not limited to drive systems, frequency inverters, AC and DC filters, HVDC, SVC, and snubber resistors. Particular requirements can be submitted to a Vishay Draloric application engineer specifying peak voltage, pulse shape, pulse duration, and environmental conditions for review.

### FEATURES

- Very high operating voltage
- Excellent pulse load capability
- Models acc. to MIL-PRF-26 available
- Adjustable type (E) available
- Non inductive type (Ni) available
- Non-flammable and enhanced humidity protection
- Material categorization: for definitions of compliance please see [www.vishay.com/doc?99912](http://www.vishay.com/doc?99912)



**RoHS**  
COMPLIANT  
HALOGEN  
**FREE**

### APPLICATIONS

- Inrush current limiter
- Capacitor charge / discharge
- Snubber resistor
- Brake resistor
- Filter resistor

TECHNICAL SPECIFICATION					
TYPE / VARIANT	RATED DISSIPATION $P_{40}$	RESISTANCE RANGE <sup>(1)</sup> TCR -10 ppm/K to -80 ppm/K	RESISTANCE RANGE <sup>(2)</sup> TCR +100 ppm/K to +180 ppm/K	RESISTANCE TOLERANCE	OPERATING VOLTAGE $U_{max.}$
RW 10/44	18 W	1.0 $\Omega$ to 3.0 $\Omega$	3.3 $\Omega$ to 36 k $\Omega$	$\pm 5\%$ , $\pm 10\%$	400 V
RW 10/44 E	11 W	1.0 $\Omega$ to 3.0 $\Omega$	3.3 $\Omega$ to 1.6 k $\Omega$		
RW 10/44 Ni	11 W	-	6.2 $\Omega$ to 2.4 k $\Omega$		
RW 12/25	11 W	0.39 $\Omega$ to 1.3 $\Omega$	1.5 $\Omega$ to 13 k $\Omega$		120 V
RW 12/38	15 W	1.0 $\Omega$ to 2.7 $\Omega$	3.0 $\Omega$ to 33 k $\Omega$		
RW 12/38 E	14 W	-	4.3 $\Omega$ to 1.5 k $\Omega$		350 V
RW 12/38 Ni	14 W	-	5.6 $\Omega$ to 2.2 k $\Omega$		
RW 12/51	25 W	1.0 $\Omega$ to 3.9 $\Omega$	4.3 $\Omega$ to 56 k $\Omega$		600 V
RW 12/51 E	17 W	1.0 $\Omega$ to 4.3 $\Omega$	4.7 $\Omega$ to 2.4 k $\Omega$		
RW 12/51 Ni	17 W	-	9.1 $\Omega$ to 3.6 k $\Omega$		1000 V
RW 12/76	45 W	2.0 $\Omega$ to 6.8 $\Omega$	7.5 $\Omega$ to 91 k $\Omega$		
RW 12/76 E	27 W	2.0 $\Omega$ to 6.8 $\Omega$	7.5 $\Omega$ to 4.3 k $\Omega$		
RW 12/76 Ni	27 W	-	16 $\Omega$ to 6.2 k $\Omega$		
RW 20/76	70 W	1.0 $\Omega$ to 11 $\Omega$	12 $\Omega$ to 75 k $\Omega$		
RW 20/76 E	42 W	1.0 $\Omega$ to 11 $\Omega$	12 $\Omega$ to 6.8 k $\Omega$		
RW 20/76 Ni	42 W	-	24 $\Omega$ to 10 k $\Omega$		1400 V
RW 20/102	90 W	3.0 $\Omega$ to 16 $\Omega$	18 $\Omega$ to 110 k $\Omega$		
RW 20/102 E	55 W	3.0 $\Omega$ to 16 $\Omega$	18 $\Omega$ to 10 k $\Omega$		
RW 20/102 Ni	55 W	-	36 $\Omega$ to 15 k $\Omega$		1600 V
RW 30/102	130 W	7.5 $\Omega$ to 10 $\Omega$	2.7 $\Omega$ to 6.8 $\Omega$		
			11 $\Omega$ to 160 k $\Omega$		
RW 30/102 E	80 W	7.5 $\Omega$ to 10 $\Omega$	2.7 $\Omega$ to 6.8 $\Omega$		
			11 $\Omega$ to 15 k $\Omega$		



TECHNICAL SPECIFICATION						
TYPE / VARIANT	RATED DISSIPATION $P_{40}$	RESISTANCE RANGE <sup>(1)</sup> TCR -10 ppm/K to -80 ppm/K	RESISTANCE RANGE <sup>(2)</sup> TCR +100 ppm/K to +180 ppm/K	RESISTANCE TOLERANCE	OPERATING VOLTAGE $U_{max}$	
RW 30/152	220 W	12 $\Omega$ to 16 $\Omega$	4.7 $\Omega$ to 11 $\Omega$ 18 $\Omega$ to 200 k $\Omega$	$\pm 5\%$ , $\pm 10\%$	2500 V	
RW 30/152 E	130 W	12 $\Omega$ to 16 $\Omega$	4.7 $\Omega$ to 11 $\Omega$ 18 $\Omega$ to 24 k $\Omega$			
RW 30/203	300 W	16 $\Omega$ to 22 $\Omega$	6.8 $\Omega$ to 15 $\Omega$ 24 $\Omega$ to 270 k $\Omega$		3600 V	
RW 30/203 E	180 W	16 $\Omega$ to 22 $\Omega$	6.8 $\Omega$ to 15 $\Omega$ 24 $\Omega$ to 36 k $\Omega$			
RW 30/267	400 W	24 $\Omega$ to 30 $\Omega$	8.2 $\Omega$ to 22 $\Omega$ 33 $\Omega$ to 390 k $\Omega$		5000 V	
RW 30/267 E	240 W	24 $\Omega$ to 30 $\Omega$	8.2 $\Omega$ to 22 $\Omega$ 33 $\Omega$ to 47 k $\Omega$			
RW 30/305	480 W	27 $\Omega$ to 36 $\Omega$	10 $\Omega$ to 24 $\Omega$ 39 $\Omega$ to 300 k $\Omega$		6000 V	
RW 30/305 E	290 W	27 $\Omega$ to 36 $\Omega$	10 $\Omega$ to 24 $\Omega$ 39 $\Omega$ to 56 k $\Omega$			
RW 29 <sup>(3)</sup>	11 W	-	4.3 $\Omega$ to 5.6 k $\Omega$		$\pm 5\%$	400 V
RW 30 <sup>(3)</sup>	11 W	-	3.6 $\Omega$ to 2.7 k $\Omega$			120 V
RW 31 <sup>(3)</sup>	14 W	-	3.9 $\Omega$ to 6.8 k $\Omega$			350 V
RW 32 <sup>(3)</sup>	17 W	-	4.3 $\Omega$ to 10 k $\Omega$			600 V
RW 33 <sup>(3)</sup>	26 W	-	8.2 $\Omega$ to 18 k $\Omega$	1000 V		
RW 35 <sup>(3)</sup>	55 W	-	18 $\Omega$ to 43 k $\Omega$	1400 V		
RW 36 <sup>(3)</sup>	78 W	-	24 $\Omega$ to 56 k $\Omega$	1600 V		
RW 37 <sup>(3)</sup>	113 W	-	33 $\Omega$ to 91 k $\Omega$	2500 V		
RW 38 <sup>(3)</sup>	159 W	-	47 $\Omega$ to 150 k $\Omega$	3600 V		
RW 47 <sup>(3)</sup>	210 W	-	75 $\Omega$ to 180 k $\Omega$	5000 V		

**Notes**

- The operating temperature range for these resistors is from -55 °C up to 350 °C.
  - Resistance values are to be selected for  $\pm 10\%$  from the E12 series, and for  $\pm 5\%$  from the E24 series.
- <sup>(1)</sup> Values with the TCR of -10 ppm/K to -80 ppm/K are produced with corrugated ribbon.  
<sup>(2)</sup> Low ohmic values with the TCR of +100 ppm/K to +180 ppm/K are produced with corrugated ribbon.  
<sup>(3)</sup> Types according to MIL-PRF-26.

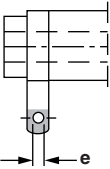
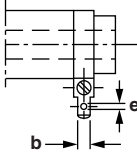
TERMINALS		
	SL	FST
		
<b>TYPE / VARIANT</b>	Lug for soldering	Fast on terminal with 6.3 mm x 0.8 mm DIN 46244
RW 10/44 RW 10/44 E RW 10/44 Ni RW 29 <sup>(1)</sup>	e = 3.2 mm	e = 1.65 mm b = 6.3 mm
RW 12/25 RW 30 <sup>(1)</sup>		-
RW 12/38 RW 12/38 E RW 12/38 Ni RW 31 <sup>(1)</sup>		e = 1.65 mm b = 6.3 mm
RW 12/51 RW 12/51 E RW 12/51 Ni RW 32 <sup>(1)</sup>		
RW 12/76 RW 12/76 E RW 12/76 Ni RW 33 <sup>(1)</sup>		
RW 20/76 RW 20/76 E RW 20/76 Ni		
RW 20/102 RW 20/102 E RW 20/102 Ni RW 35 <sup>(1)</sup>	e = 4.2 mm	e = 1.65 mm b = 6.3 mm
RW 30/102 RW 30/102 E RW 36 <sup>(1)</sup>		
RW 30/152 RW 30/152 E RW 37 <sup>(1)</sup>		
RW 30/203 RW 30/203 E RW 38 <sup>(1)</sup>		
RW 30/267 RW 30/267 E RW 47 <sup>(1)</sup>		
RW 30/305 RW 30/305 E		

**Note**

<sup>(1)</sup> Types according to MIL-PRF-26.



PACKAGING				
TYPE	PACKAGING CODE	QUANTITY	FORMAT	DIMENSION OF PACKAGE
All	LX	Variable	Bulk, separately packed with paper	Box size selection according to quantity and product size

**PART NUMBER AND PRODUCT DESCRIPTION**

Part Number: RW0104411009JLX000

R W 0 1 0 4 4 1 1 0 0 9 J L X 0 0 0

MODEL	SPECIAL CHARACTER	VALUE	TOLERANCE CODE	PACKAGING CODE	SPECIAL
RW01044 = RW 10/44 RW01225 = RW 12/25 RW01238 = RW 12/38 RW01251 = RW 12/51 RW01276 = RW 12/76 RW02076 = RW 20/76 RW20102 = RW 20/102 RW30102 = RW 30/102 RW30152 = RW 30/152 RW30203 = RW 30/203 RW30267 = RW 30/267 RW30305 = RW 30/305 RW00029 = RW 29 RW00030 = RW 30 RW00031 = RW 31 RW00032 = RW 32 RW00033 = RW 33 RW00035 = RW 35 RW00036 = RW 36 RW00037 = RW 37 RW00038 = RW 38 RW00047 = RW 47	0 = neutral 1 = E 7 = FST C = E FST	<b>3 digit value 1 digit multiplier</b> 7 = *10 <sup>-3</sup> 8 = *10 <sup>-2</sup> 9 = *10 <sup>-1</sup> 0 = *10 <sup>0</sup> 1 = *10 <sup>1</sup> 2 = *10 <sup>2</sup> 3 = *10 <sup>3</sup>	J = ± 5 % K = ± 10 %	<b>LX</b> = loose pack without quantity	<b>000</b> = standard <b>3 digit code</b> = customized version <sup>(1)</sup>

Product Description: RW 10/44 E 10R 5 %

RW 10/44	E	10R	5 %
TYPE	VARIANT / TERMINAL	RESISTANCE	TOLERANCE CODE
RW10/44 RW12/35 RW12/38 RW12/51 RW12/76 RW20/76 RW20/102 RW30/102 RW30/152 RW30/203 RW30/267 RW30/305 RW29 ... RW47	Neutral E (adjustable) FST E FST	R39 = 0.39 Ω 300K = 300 kΩ	± 5 % ± 10 %

**Notes**

- The products can be ordered using either the PRODUCT DESCRIPTION or the PART NUMBER.
- <sup>(1)</sup> For special windings or the non-inductive (RW Ni) versions, please contact: [ww1resistors@vishay.com](mailto:ww1resistors@vishay.com).



## DESCRIPTION

The rugged design and durable coating of Vitreous wirewound resistors enable them to withstand extreme environmental stress. For this reason they are well suited for use in demanding environmental conditions. The glaze is fired layer by layer several times at high temperatures (> 600 °C). This vitreous coating is designed for high stability and a long lifetime in humid environments and is resistant to all cleaning chemicals commonly used in the electronic industry.

Production is strictly controlled and follows an extensive set of instructions established for reproducibility. The winding is done with specific materials on a specially developed fine ceramic body (Al<sub>2</sub>O<sub>3</sub>). The ceramic used meets the highest requirements against mechanical resistance, thermal shock, dielectric strength, and insulation resistance at high temperatures. With different diameters and turn spacings, a large ohmic value range can be offered.

The resistors are marked with resistance and tolerance.

The RW series meets single lot / date code packaging requirements.

## MATERIALS

Vishay acknowledges the following systems for the regulation of hazardous substances:

- IEC 62474, Material Declaration for Products of and for the Electrotechnical Industry, with the list of declarable substances given therein <sup>(1)</sup>
- The Global Automotive Declarable Substance List (GADSL) <sup>(2)</sup>
- The REACH regulation (1907/2006/EC) and the related list of substances with very high concern (SVHC) <sup>(3)</sup> for its supply chain

The products do not contain any of the banned substances as per IEC 62474, GADSL, or the SVHC list, see [www.vishay.com/how/leadfree](http://www.vishay.com/how/leadfree).

Hence the products fully comply with the following directives:

- 2000/53/EC End-of-Life Vehicle Directive (ELV) and Annex II (ELV II)
- 2011/65/EU Restriction of the Use of Hazardous Substances Directive (RoHS) with amendment 2015/863/EU
- 2012/19/EU Waste Electrical and Electronic Equipment Directive (WEEE)

Vishay pursues the elimination of conflict minerals from its supply chain, see the Conflict Minerals Policy at [www.vishay.com/doc?49037](http://www.vishay.com/doc?49037).

## Notes

- (1) The IEC 62474 list of declarable substances is maintained in a dedicated database, which is available at <http://std.iec.ch/iec62474>.
- (2) The Global Automotive Declarable Substance List (GADSL) is maintained by the American Chemistry Council, and available at [www.gadsl.org](http://www.gadsl.org).
- (3) The SVHC list is maintained by the European Chemical Agency (ECHA) and available at <http://echa.europa.eu/candidate-list-table>.

## ASSEMBLY

The resistors are available with lug style terminals for soldering assembly processes or with fast plug terminals (FST style) for assembly / disassembly processes. The terminals of the resistors are completely lead (Pb)-free. The special tin plating used provides compatibility with lead (Pb)-free and lead-containing soldering processes.

Special lugs are available on request, please inquire at [ww1resistors@vishay.com](mailto:ww1resistors@vishay.com).

3D-Models are available on request, please inquire at [ww1resistors@vishay.com](mailto:ww1resistors@vishay.com).

Different mounting accessories are available, see the datasheet: [www.vishay.com/doc?21015](http://www.vishay.com/doc?21015).

The slider of the adjustable type should be only moved after removal of voltage and sufficient loosening of the screw.

## APPLICATION INFORMATION

The power dissipation of the resistor generates a temperature rise with respect to the ambient. The permissible dissipation is derated for temperatures above 40°C, as shown in the derating diagram, in order to avoid overheating of the resistor. The heat dissipated from the resistor may affect adjacent components, hence proper clearance will be required in order to avoid overheating.

All materials used are non-flammable and inorganic.

These resistors do not feature a limited lifetime when operated within the permissible limits. However, resistance value drift increasing over operating time may result in exceeding a limit acceptable to the specific application, thereby establishing a functional lifetime.

## RELATED PRODUCTS

In lower continuous power applications and less demanding environmental conditions the cement coated alternative, like the ZWS series might be suitable, see the datasheet:

“Cemented Wirewound Resistors with Lugs”  
[www.vishay.com/doc?21010](http://www.vishay.com/doc?21010)

For low ohmic values and rated dissipation up to 1000 W, there is the vitreous coated GBS series, see the datasheet:

“Vitreous Wirewound Resistors with Corrugated Ribbon”  
[www.vishay.com/doc?21004](http://www.vishay.com/doc?21004)

For higher power dissipation and different lugs, there is the vitreous coated GWS series, see the datasheet:

“Vitreous Wirewound Resistors with Lugs”  
[www.vishay.com/doc?21003](http://www.vishay.com/doc?21003)



**DERATING**

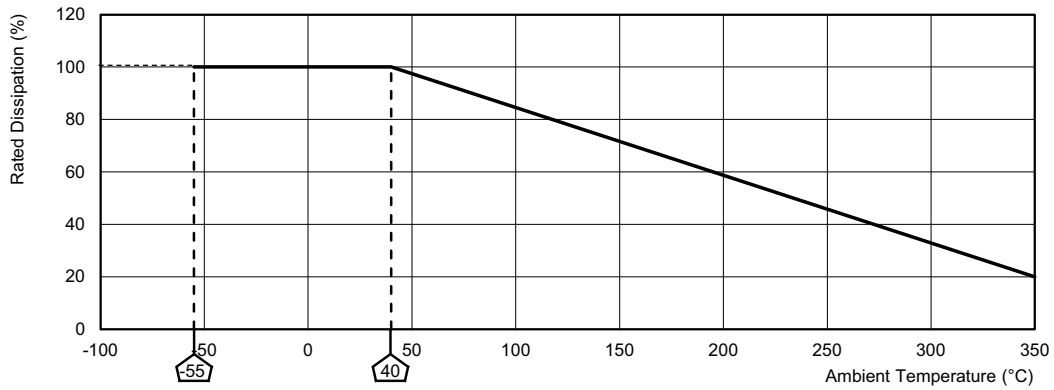

**TEMPERATURE RISE**

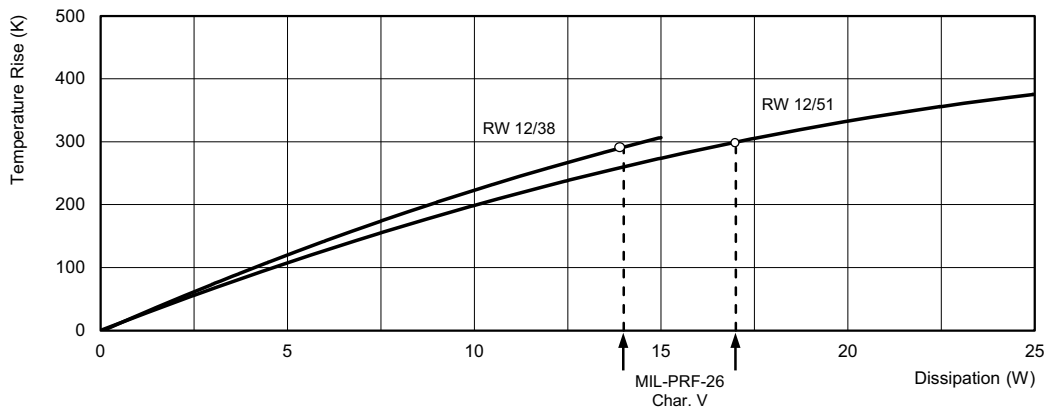
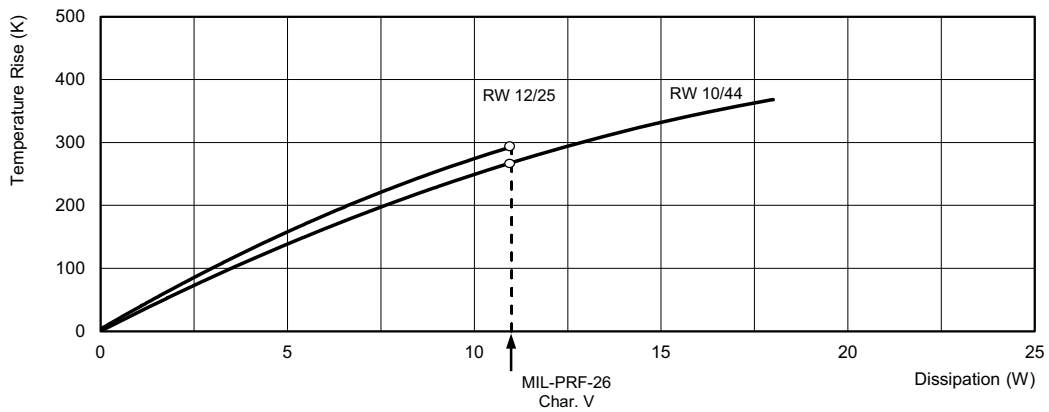



TEMPERATURE RISE

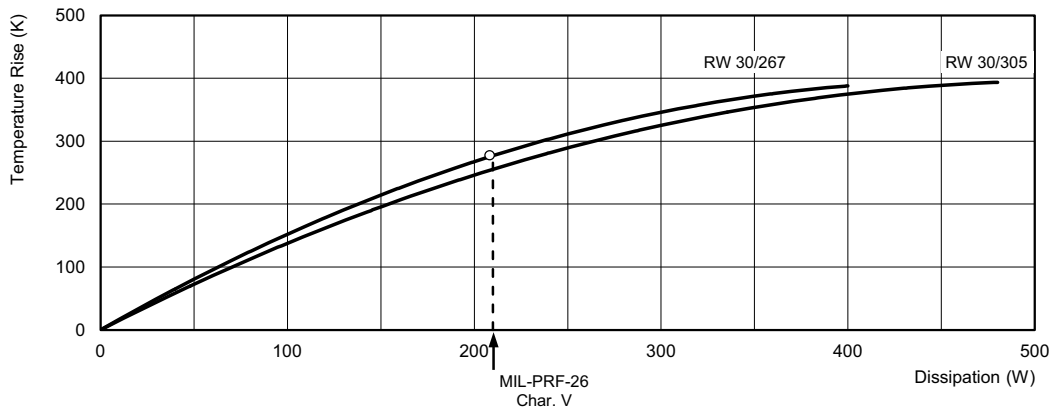
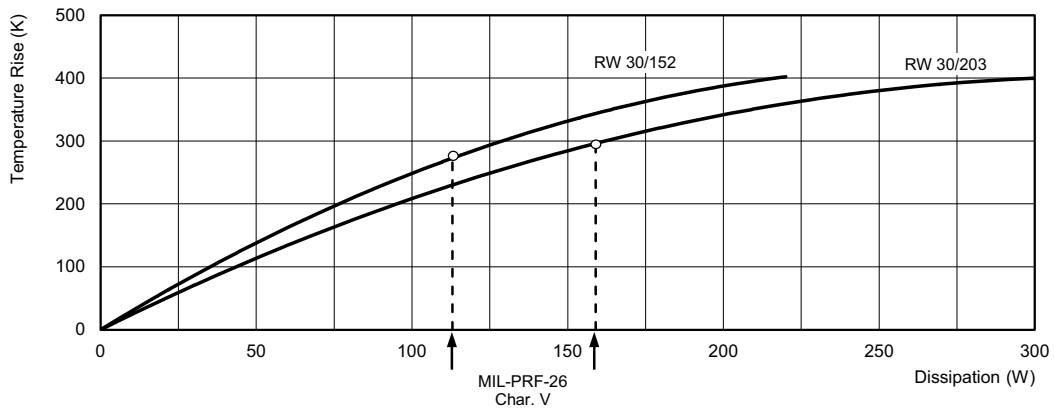
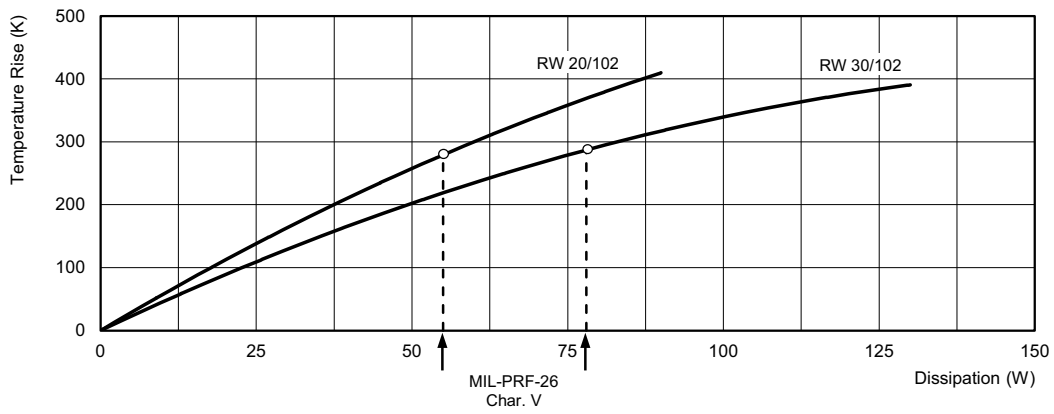
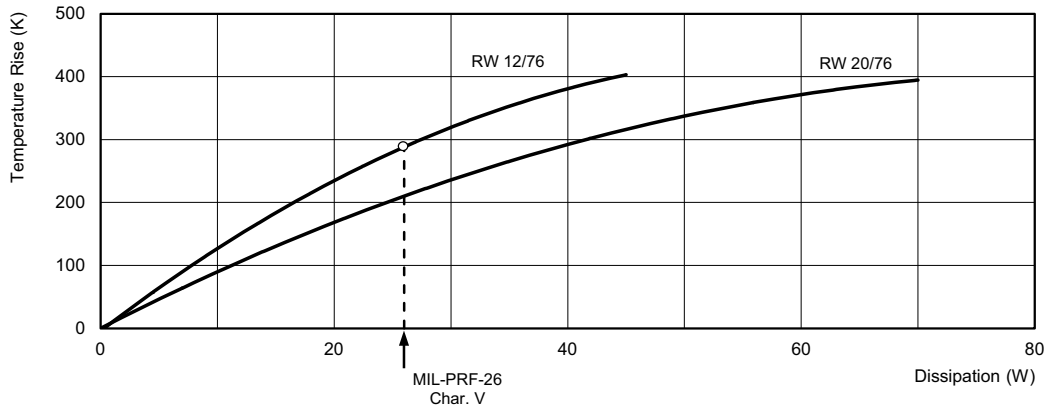

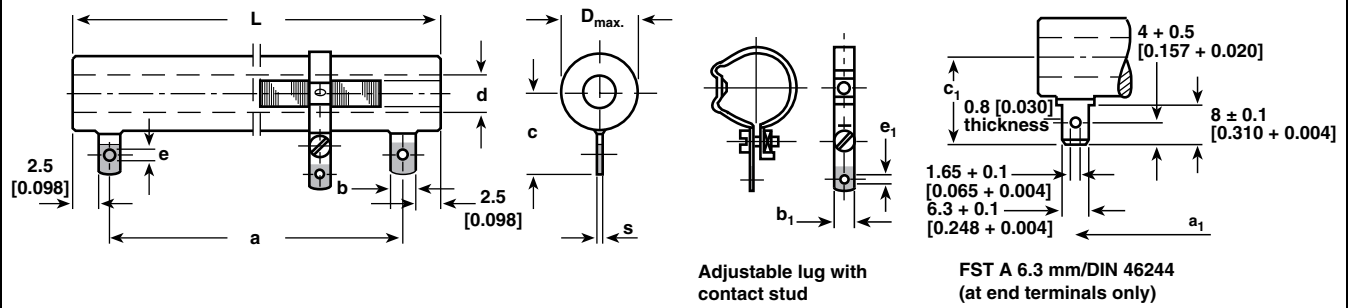
**DIMENSIONS AND MASS**

TYPE / VARIANT	$D_{max.}^{(1)}$ (mm)	L (mm)	a (mm)	$a_1$ (mm)	b (mm)	$b_1$ (mm)	c (mm)	$c_1$ (mm)	d (mm)	e (mm)	$e_1$ (mm)	s (mm)	MASS (g)
RW 10/44 RW 10/44 E RW 10/44 Ni RW 29 <sup>(2)</sup>	12.7 (15.7)	$44.4 \pm 1.6$	33.4	31.4	6.0	5.0	16.5	18.5	4.5	3.2	2.8	0.6	10
RW 12/25 RW 30 <sup>(2)</sup>	15.1 (18.1)	$25.4 \pm 1.6$	14.4	-	6.0	-	17.5	-	5.5	3.2	-	0.6	10
RW 12/38 RW 12/38 E RW 12/38 Ni RW 31 <sup>(2)</sup>	15.1 (18.1)	$38.1 \pm 1.6$	27.1	25.1	6.0	5.0	17.5	19.0	5.5	3.2	3.2	0.6	10
RW 12/51 RW 12/51 E RW 12/51 Ni RW 32 <sup>(2)</sup>	15.1 (18.1)	$50.8 \pm 1.6$	39.8	37.8	6.0	5.0	17.5	19.0	5.5	3.2	3.2	0.6	15
RW 12/76 RW 12/76 E RW 12/76 Ni RW 33 <sup>(2)</sup>	15.1 (18.1)	$76.2 \pm 1.6$	65.2	63.2	6.0	5.0	17.5	19.0	5.5	3.2	3.2	0.6	15
RW 20/76 RW 20/76 E RW 20/76 Ni	23.0 (26.0)	$76.2 \pm 1.6$	63.2	63.2	8.0	5.0	22.0	23.0	12.0	4.2	3.2	0.8	30
RW 20/102 RW 20/102 E RW 20/102 Ni RW 35 <sup>(2)</sup>	23.0 (26.0)	$101.6 \pm 1.6$	88.6	88.6	8.0	5.0	22.0	23.0	12.0	4.2	3.2	0.8	62
RW 30/102 RW 30/102 E RW 36 <sup>(2)</sup>	33.3 (36.3)	$101.6 \pm 1.6$	88.6	88.6	8.0	8.0	31.0	27.0	18.5	4.2	4.2	0.8	136
RW 30/152 RW 30/152 E RW 37 <sup>(2)</sup>	33.3 (36.3)	$152.4 \pm 1.6$	139.4	139.4	8.0	8.0	31.0	27.0	18.5	4.2	4.2	0.8	200
RW 30/203 RW 30/203 E RW 38 <sup>(2)</sup>	33.3 (36.3)	$203.2 \pm 1.6$	190.2	190.2	8.0	8.0	31.0	27.0	18.5	4.2	4.2	0.8	260
RW 30/267 RW 30/267 E RW 47 <sup>(2)</sup>	33.3 (36.3)	$266.7 \pm 1.6$	253.7	253.7	8.0	8.0	31.0	27.0	18.5	4.2	4.2	0.8	330
RW 30/305 RW 30/305 E	33.3 (36.3)	$304.8 \pm 1.6$	291.8	291.8	8.0	8.0	31.0	27.0	18.5	4.2	4.2	0.8	430

**Notes**

<sup>(1)</sup> Numbers in (parenthesis) represent the dimension  $D_{max.}$  for resistor produced with corrugated ribbon.

<sup>(2)</sup> Types according to MIL-PRF-26.





## **Disclaimer**

ALL PRODUCT, PRODUCT SPECIFICATIONS AND DATA ARE SUBJECT TO CHANGE WITHOUT NOTICE TO IMPROVE RELIABILITY, FUNCTION OR DESIGN OR OTHERWISE.

Vishay Intertechnology, Inc., its affiliates, agents, and employees, and all persons acting on its or their behalf (collectively, "Vishay"), disclaim any and all liability for any errors, inaccuracies or incompleteness contained in any datasheet or in any other disclosure relating to any product.

Vishay makes no warranty, representation or guarantee regarding the suitability of the products for any particular purpose or the continuing production of any product. To the maximum extent permitted by applicable law, Vishay disclaims (i) any and all liability arising out of the application or use of any product, (ii) any and all liability, including without limitation special, consequential or incidental damages, and (iii) any and all implied warranties, including warranties of fitness for particular purpose, non-infringement and merchantability.

Statements regarding the suitability of products for certain types of applications are based on Vishay's knowledge of typical requirements that are often placed on Vishay products in generic applications. Such statements are not binding statements about the suitability of products for a particular application. It is the customer's responsibility to validate that a particular product with the properties described in the product specification is suitable for use in a particular application. Parameters provided in datasheets and / or specifications may vary in different applications and performance may vary over time. All operating parameters, including typical parameters, must be validated for each customer application by the customer's technical experts. Product specifications do not expand or otherwise modify Vishay's terms and conditions of purchase, including but not limited to the warranty expressed therein.

Except as expressly indicated in writing, Vishay products are not designed for use in medical, life-saving, or life-sustaining applications or for any other application in which the failure of the Vishay product could result in personal injury or death. Customers using or selling Vishay products not expressly indicated for use in such applications do so at their own risk. Please contact authorized Vishay personnel to obtain written terms and conditions regarding products designed for such applications.

No license, express or implied, by estoppel or otherwise, to any intellectual property rights is granted by this document or by any conduct of Vishay. Product names and markings noted herein may be trademarks of their respective owners.