

Particulate Filter Numbering System = "Most Popular"

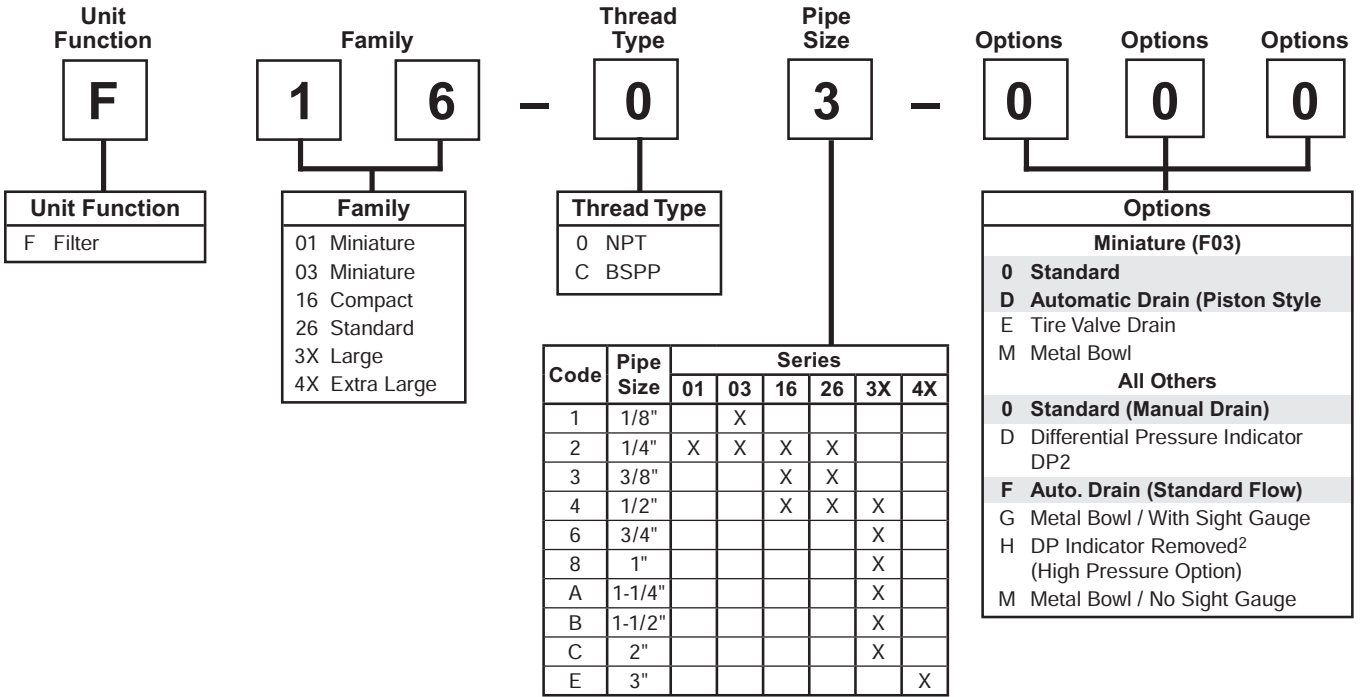

¹ Ports on some units are BSPP-G, others are BSPT-Rc. Consult specific model page for specifications.

² Models F35, F36, F37 & F43.

"F" Series Filters, Type "A" 5 micron elements: All Wilkerson Type "A" micron elements **meet or exceed ISO Class 3** for maximum particle size and concentration of solid contaminants.

NOTE: All classes above refer to International Standards Organization (ISO) standard 8573-1, pertaining to maximum particle size and concentration of solid contaminants, and maximum oil content.

If more than one option is desired, arrange them in alphabetical order in positions 6, 7, and 8.

NOTE: 000 in position 6, 7, and 8 signifies standard product.

Particulate Filter

F26

 = "Most Popular"

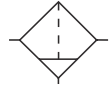

Manual Drain

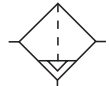

Auto Drain



F26-02-000

Features

- Manual Drain
- 5 Micron Rated Element
- Quick-disconnect Bowl Guard with Integral Plastic Bowl and Safety Latch

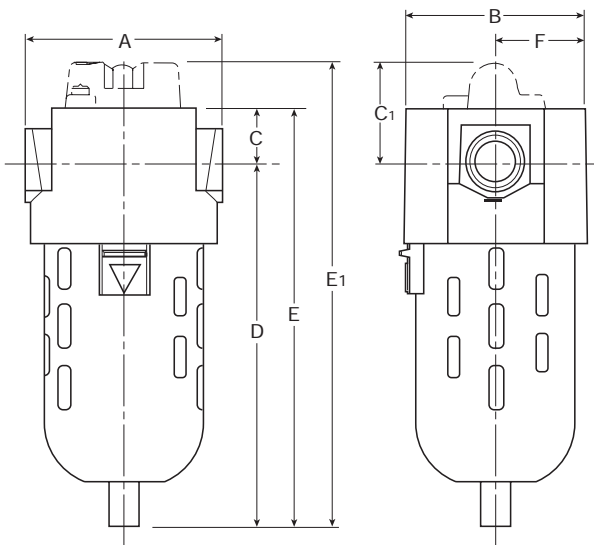

Specifications

Flow Capacity*	1/4	81.3 SCFM (28.3 dm ³ /s)
	3/8	117.8 SCFM (55.5 dm ³ /s)
	1/2	149.8 SCFM (70.6 dm ³ /s)
Maximum Supply Pressure	Plastic Bowl	150 PSIG (10,3 bar)
	Metal Bowl	200 PSIG (13,8 bar)
Operating Temperature	Plastic Bowl	32° to 125°F (0° to 52°C)
	Metal Bowl	32° to 150°F (0° to 65.5°C)
Port Size	NPT / BSPP-G	1/4, 3/8, 1/2
Standard Filtration	5 Micron	
Weight	2.9 lb. (1.3 kg)	

* Inlet pressure 150 PSIG (10.3 bar). Pressure drop 5 PSID (0.3 bar).

"F" Series Filters, Type "A" 5 micron elements: All Wilkerson Type "A" 5 micron elements **meet or exceed ISO Class 3** for maximum particle size and concentration of solid contaminants.

Materials of Construction

Baffle	Acetal	
Body	Zinc	
Bowls	Plastic Bowl	Polycarbonate
	Metal Bowl	Zinc
Deflector	Polypropylene	
Element Retainer	Acetal	
Filter Element	Polyethylene	
Seals	Plastic Bowl	Nitrile
	Metal Bowl	Fluorocarbon
Sight Gauge	Metal Bowl	Polycarbonate

Dimensions

Models	Inches (mm)	A	B	C	C ₁	D	E	E ₁	F
Standard Unit F26-XX-000		3.30 (84)	3.00 (76)	1.00 (25.4)	—	6.40 (162.6)	7.40 (188)	—	1.50 (38)
Differential Pressure Indicator F26-XX-D00		3.30 (84)	3.00 (76)	1.00 (25.4)	1.83 (46.5)	6.40 (162.6)	7.40 (188)	8.23 (209)	1.50 (38)
Automatic Drain F26-XX-F00		3.30 (84)	3.00 (76)	1.00 (25.4)	—	6.40 (162.6)	7.54 (191.5)	—	1.50 (38)
Metal Bowl / Metal Bowl with Sight Gauge F26-XX-G00		3.30 (84)	3.00 (76)	1.00 (25.4)	—	6.40 (162.6)	7.30 (185)	—	1.50 (38)

= "Most Popular"

Replacement Bowl Kits

- Metal Bowl –
 - Automatic Drain GRP-95-960
 - Manual Drain GRP-95-930
 - Sight Gauge, Manual Drain GRP-95-931
- Plastic Bowl –
 - Automatic Drain GRP-95-948
 - Bowl Guard, Manual Drain GRP-95-935
 - Manual Drain GRP-95-929

Replacement Element Kits

- Type "A", 5 Micron FRP-95-115

Accessories

- Automatic Drain, Nitrile GRP-95-973
- Manual Drain FRP-95-610
- Sight Gauge Kit GRP-95-079

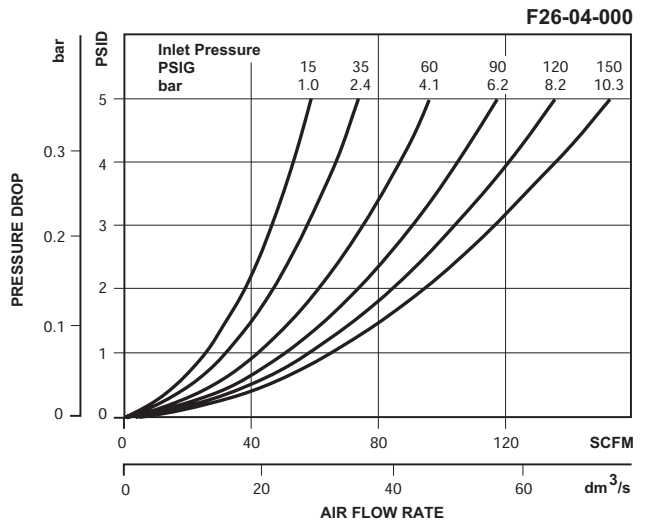
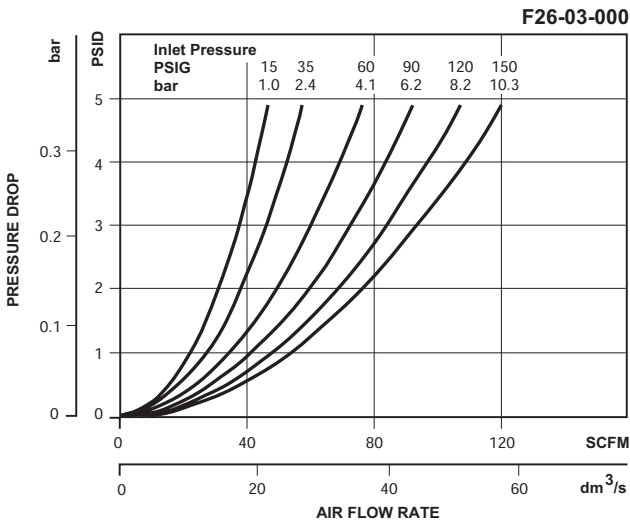
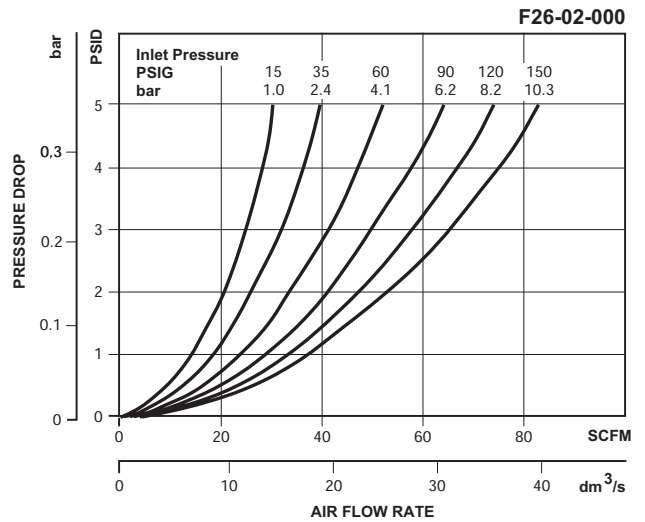

Ordering Information

Model Type	Port Size	Polycarbonate Bowl / Bowl Guard	Metal Bowl	Metal Bowl / Sight Gauge	Polycarbonate Bowl / Bowl Guard / Differential Pressure Indicator
Manual Drain	1/4	F26-02-000	F26-02-M00	F26-02-G00	F26-02-D00
	3/8	F26-03-000	F26-03-M00	F26-03-G00	F26-03-D00
	1/2	F26-04-000	F26-04-M00	F26-04-G00	F26-04-D00
Automatic Drain	1/4	F26-02-F00	F26-02-FM0	F26-02-FG0	F26-02-DF0
	3/8	F26-03-F00	F26-03-FM0	F26-03-FG0	F26-03-DF0
	1/2	F26-04-F00	F26-04-FM0	F26-04-FG0	F26-04-DF0

Options - To order an option supplied with the unit model, add the appropriate coded suffix letter in the designated position of the model number.