

# Alco Controls

## Pressure Controls PS1 / PS2 Series

Technical Bulletin

Adjustable Single and Dual Pressure Controls for high and low pressure applications.

### Features

- Adjustable pressure range
- Narrow adjustable differential depending on model
- Range and differential pointer in units bar and psig
- Range and differential individually lockable by wire seal
- High rated SPDT contacts for all versions
- Shatter resistant contacts
- Heavy duty, finger-proof terminal blocks
- Captive terminal and cover screws
- Dual pressostats with two independent SPDT switches
- Manual toggle for system checkout and override
- Standard pressure connection 7/16"-20 UNF for 1/4" SAE male flare connection
- Low pressure and high pressure versions available with TÜV approval according to EN 12263 to meet requirements of DIN 8901 and EN 378
- Automatic and manual reset versions
- Some versions with convertible auto/manual reset
- Locking plate and mounting screws included

### Options (minimum lot size 100 pieces)

- Alternative pressure connectors including 6 mm ODF solder connection
- Factory set to customer specification



Single Pressostat PS1



Dual Pressostat PS2

### Selection Table Single Pressure Controls PS1

Type	PCN	Adjustment Range		Lowest Setpoint bar	Factory Setting bar	Leakage Test Pressure bar	Pressure Connection
		Upper Setpoint bar	Differential Setpoint bar				

#### Low Pressure Controls

PS1-A3A	4 370 700	-0.5 ... 7	0.5 ... 5	-0.9	3.5 / 4.5	24	7/16"-20 UNF
PS1-A3K	4 370 600						capillary/nut
PS1-A3L	4 714 945						cap./solder tube 1/4"
PS1-A3U	4 712 201						solder 6 mm
PS1-A3X	4 713 430						solder tube 1/4"
PS1-R3A	4 350 100	-0.5 ... 7	External reset approx. 1bar above setpoint	-0.9	3.5	24	7/16"-20 UNF
PS1-R3K	4 713 431						Capillary/nut

#### High Pressure Controls

PS1-A5A	4 350 500	6 ... 31	2 ... 15	3	16 / 20	35	7/16"-20 UNF
PS1-A5K	4 370 400						capillary/nut
PS1-A5L	4 715 136						cap./solder tube 1/4"
PS1-A5U	4 713 325						solder 6 mm
PS1-A5X	4 713 434						solder tube 1/4"
PS1-R5A	4 350 700	6 ... 31	External reset approx. 3bar below setpoint	-	20	35	7/16"-20 UNF
PS1-R5K	4 370 300						capillary/nut

## Pressure Controls PS1 / PS2 Series

### Selection Table Single Pressure Controls PS1 TÜV (EN 12263)

Type	PCN	Adjustment Range		Lowest Setpoint bar	Factory Setting bar	Leakage Test Pressure bar	Pressure Connection
		Upper Setpoint bar	Differential Setpoint bar				

#### Pressure Limiter for low pressure protection EN 12263 PSL (automatic reset)

PS1-W3A	4 368 300	-0.5 ... 7	0.5 ... 5	-0.9	3.5 / 4.5	24	7/16"-20 UNF
PS1-W3U	4 713 437						solder 6 mm

#### Pressure Cut Out for low pressure protection EN 12263 PZL (external reset)

PS1-B3A	4 470 400	-0.5 ... 7	External reset approx. 1bar above setpoint	-0.9	3.5	24	7/16"-20 UNF
PS1-B3U	4 715 141						solder 6 mm

#### Pressure Limiter for high pressure protection EN 12263 PSH (automatic reset)

PS1-W5A	4 353 200	6 ... 31	2 ... 15	3	16 / 20	35	7/16"-20 UNF
PS1-W5K	4 359 100						capillary/nut
PS1-W5U	4 713 439						solder 6 mm

#### Pressure Cut Out for high pressure protection EN 12263 PZH (external manual reset)

PS1-B5A	4 353 300	6 ... 31	External reset approx. 3bar below setpoint	-	20	35	7/16"-20 UNF
PS1-B5J	4 715 758						cap./solder 6mm
PS1-B5U	4 712 332						solder 6 mm

#### Safety Pressure Cut Out for high pressure protection EN 12263 PZHH (internal manual reset)

PS1-S5A	4 368 400	6 ... 31	Internal reset approx. 3bar below setpoint	-	21	35	7/16"-20 UNF
PS1-S5U	4 711 591						solder 6 mm

### Selection Table Dual Pressure Controls PS2

Type	PCN	Adjustment Range				Factory Setting		Leakage Test Pressure		Pressure Connection
		Upper Setpoint left bar	Upper Setpoint right bar	Differential left bar	Differential right bar	left bar	right bar	left bar	right bar	

#### Combined Low and High Pressure Controls

PS2-A7A	4 353 400	-0.5 ... 7	6 ... 31	0.5 <sup>1</sup> ... 5	ca. 4 fix	3.5 / 4.5	20	24	35	7/16"-20 UNF
PS2-A7K	4 350 900									capillary/nut
PS2-A7L	4 713 565									cap./solder 1/4"
PS2-A7U	4 713 415									solder 6 mm
PS2-A7X	4 713 416									solder tube 1/4"
PS2-L7A	4 351 100	-0.5 ... 7	6 ... 31	0.5 <sup>1</sup> ... 5	Ext. reset approx. 4bar below setpoint	3.5 / 4.5	20	24	35	7/16"-20 UNF
PS2-L7K	4 370 500									capillary nut
PS2-L7U	4 713 417									solder 6 mm
PS2-R7A	4 351 300	-0.5 ... 7	6 ... 31	Ext. reset approx. 1bar above setpoint	Ext. reset approx. 4bar below setpoint	3.5	20	24	35	7/16"-20 UNF
PS2-R7K	4 713 421									capillary nut
PS2-R7U	4 713 419									solder 6 mm

#### Dual Pressure Controls PS2 TÜV (EN 12263)

##### Combined Pressure Limiter for low pressure / high pressure protection EN 12263; PSL / PSH (automatic / automatic)

PS2-W7A	4 360 100	-0.5 ... 7	6 ... 31	0.5 <sup>1</sup> ... 5	ca. 4 fix	3.5 / 4.5	20	24	35	7/16"-20 UNF
PS2-W7L	4 450 300									cap./solder 1/4"
PS2-W7U	4 712 436									solder 6 mm

<sup>1</sup> lowest possible setpoint: -0.9 bar

## Pressure Controls PS1 / PS2 Series

### Selection Table Dual Pressure Controls PS2 (cont'd)

Type	PCN	Adjustment Range				Factory Setting		Leakage Test Pressure		Pressure Connection
		Upper Setpoint left bar	right bar	Differential left bar	right bar	left bar	right bar	left bar	right bar	

#### Combined Pressure Limiter / Pressure Cut Out for low pressure / high pressure protection EN 12263; PSL / PZH (automatic / external manual reset)

PS2-C7A	4 353 500	-0.5 ... 7	6 ... 31	0.5 <sup>1</sup> ... 5	Ext. reset approx. 4bar below setpoint	3.5 / 4.5	20	24	35	7/16"-20 UNF
PS2-C7L	5 715 131									cap./solder 1/4"

#### Combined Low and High Pressure Controls. High side convertible from automatic to manual reset

PS2-M7A	4 361 300	-0.5 .. 7	6 ... 31	0.5 <sup>1</sup> ... 5	-	3.5 / 4.5	21	24	35	7/16"-20 UNF
---------	-----------	-----------	----------	------------------------	---	-----------	----	----	----	--------------

#### Combined Pressure Limiter Safety Pressure Cut Out for low pressure / high pressure protection EN 12263 PSL / PZH (automatic / automatic convertible to external manual reset)

PS2-N7A	4 715 756	-0.5 .. 7	6 ... 31	0.5 <sup>1</sup> ... 5	-	3.5 / 4.5	21	24	35	7/16"-20 UNF
---------	-----------	-----------	----------	------------------------	---	-----------	----	----	----	--------------

#### Combined Pressure Limiter / Safety Pressure Cut Out for low pressure / high pressure protection EN 12263 PSL / PZHH (automatic / internal manual reset)

PS2-T7A	4 368 500	-0.5 .. 7	6 ... 31	0.5 <sup>1</sup> ... 5	Int. reset approx. 4bar below setpoint	3.5 / 4.5	21	24	35	7/16"-20 UNF
PS2-T7U	4 713 424									solder 6 mm

#### Combined Pressure Cut Out for low pressure / high pressure protection EN 12263 PZL / PZH (external manual reset / external manual reset)

PS2-B7A	4 360 200	-0.5 .. 7	6 ... 31	Ext. reset approx. 1bar above setpoint	Ext. reset approx. 4bar below setpoint	3.5	20	24	35	7/16"-20 UNF
PS2-B7K	4 446 600									capillary nut
PS2-B7L	4 446 700									cap./solder 1/4"
PS2-B7U	4 449 400									solder 6 mm

#### Combined Pressure Cut Out / Safety Pressure Cut Out for high pressure / high pressure protection EN 12263 PZH / PZHH (external manual reset / internal manual reset)

PS2-G8A	4 368 600	6 ... 31	6 ... 31	Ext. reset approx. 4bar below setpoint	Int. reset approx. 4bar below setpoint	20	21	35	35	7/16"-20 UNF
PS2-G8U	4 713 427									solder 6 mm
PS2-G8X	4 713 428									solder tube 1/4"

<sup>1</sup> lowest possible setpoint: -0.9 bar

### Technical data

#### Environmental conditions

Ambient temperatures storage and transportation: operation:	-50 °C to +70 °C -50 °C to +70 °C
Medium temperature range TS at pressure connector:	-50 °C to +70 °C
Dust and water protection EN 60529 / IEC 529:	IP44 Control mounted flush against wall
Vibration resistance:	4g @ 10 ... 1000 Hz

#### Electrical contacts

Type of contacts	- PS1: 1 x SPDT contact - PS2: 2 x SPDT contacts
Contact material - standard:	CuAg3
Heating load (AC1):	24A / 230V AC
Inductive load (AC15):	10A / 230V AC
Startup / Locked Rotor UL:	144A / 120 / 240V AC
Inductive load (DC 13):	0.1A / 230V DC; 3A / 24V DC 6A / 12V DC
Motor rating UL (FLA):	24A / 120 / 240V AC

#### Materials and compatibility

Housing materials cover: frame:	Polycarbonate (PC) Steel, with ROHS compatible anti corrosion protection
Materials with medium contact pressure conn. (A) / bellows: pressure conn. (K,L,U,X) / bellows:	brass /bronze copper / bronze
Medium compatibility	HFC, HCFC

#### Approvals

EN 12263 (TÜV)	specific models, see selection
Low Voltage Directive 73/23/EWG 93/68/EWG; EN 60947-1, EN 60947-5-1:	all models
UL / CSA:	File Nr. E85974
German Lloyd	standard models when used with marine cable glands (accessory)

## Pressure Controls PS1 / PS2 Series

### Name Scheme Adjustable Single Pressostats

**PS 1 - A 7 A**

#### Product Name

PS1 = standard version  
PSA = customer specific version

#### Function

A = Pressure control, automatic reset  
B = Pressure cut out, external manual reset EN 12263  
R = Pressure control, external manual reset  
S = Safety pressure cut out, internal manual reset EN 12263  
U = Convertible from R to A  
W = Pressure limiter, automatic, DIN / EN 12263  
X = Pressure control, automatic with extended adjustment spindles

#### Pressure Connector

A = 7/16"-20 UNF male  
C = R 1/4" male, stainless steel with steel bellows  
J = 1 m capillary with 6mm-ODM solder tube  
K = 1 m capillary with 7/16"-20 UNF flare nut and schrader valve opener  
L = 1 m capillary with 1/4"-ODM solder tube  
U = 6 mm ODF solder, 80 mm length  
X = 1/4"-ODF solder, 80 mm length

#### Pressure Range

1 = -0,75 ... 3 bar  
2 = -0,8 ... 1.5 bar  
3 = -0,5 ... 7 bar  
4 = 1 ... 20 bar  
5 = 6 ... 31 bar

### Name Scheme Adjustable Dual Pressostats

**PS 2 - A 7 A**

#### Product Name

PS2 = standard version  
PSB = customer specific version

#### Function

A = both sides: automatic pressure controls  
B = both sides: cut out, external manual reset, EN 12263  
C = left side: pressure limiter, automatic, EN 12263  
right side: cut out, external manual reset, EN 12263  
G = left side: cut out, external manual reset, EN 12263  
right side: safety cut out, internal manual reset, EN 12263  
L = left side: automatic pressure control,  
right side: external manual reset  
M = left side: automatic pressure control,  
right side: convertible from R to A.  
N = left side: automatic pressure control, EN 12263  
right side: convertible from R to A EN 12263.  
R = both sides: external manual reset  
S = both sides: safety cut out, internal manual reset, EN 12263  
T = left side: pressure limiter, automatic, EN 12263  
right side: safety cut out, internal manual reset, EN 12263  
U = both sides: convertible from R to A  
W = both sides: pressure limiter, automatic reset, DIN / EN 12263  
X = both sides automatic pressure controls;  
extended adjustment spindles  
Y = left side: automatic reset, right side: convertible from R to A;  
extended adjustment spindles  
Z = both sides convertible from R to A;  
extended adjustment spindles

#### Pressure Connector

A = 7/16"-20 UNF male  
C = R 1/4" male, stainless steel with steel bellows  
K = 1 m cap tube and schrader valve opener,  
7/16"-20 UNF flare nut  
L = 1/4"-ODM solder with 1 m cap tube  
U = 6 mm ODF solder, 80 mm length  
X = 1/4"-ODF solder, 80 mm length

#### Pressure Range

	left side	right side
7 =	-0,5 ... 7 bar	6 ... 31 bar
8 =	6 ... 31 bar	6 ... 31 bar
9 =	-0,75 ... 3 bar	6 ... 31 bar

# Pressure Controls PS1 / PS2 Series

## General Hints

High pressure limiters and pressure cut outs with type approval according to EN 12263 feature a double bellows design.

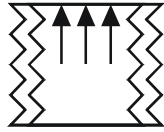

Should the inner bellows leak, then the larger surface area of the outer bellows creates a larger force and causes the pressostat to a pre-empted cut out. This represents a fail-safe function.

## Electrical contacts

PS1 / PS2 pressure controls are equipped with high rated double snap action contacts for shatter-free and reliable operation. All contacts are designed as Single Pole Double Throw (SPDT) contacts. Dual Pressostats PS2 come with two independently actuated SPDT contacts.

## Switch Points

The set points are adjustable with internal adjustment spindles. The range spindle allows presetting the *upper switch point* together with the *lower switch point*. The differential spindle is used to preset the *lower switch point*. The dependency between upper and lower set point is as follows:

$$\text{lower set point} = \text{upper set point} - \text{differential}$$

Parts with manual reset feature a fixed differential. Manual reset is possible as soon as pressure falls below / rises above this fixed differential (see selection table).

## Contact function

Contacts on Single Pressostats PS1 are labeled 1-2-4, contacts on Dual Pressostats are labeled 11-12-14 on the left side and 21-22-24 on the right side.

'1', '11', '21' refer to the common pole.

'2', '12', '22' refer to the lower setpoint and

'4', '14', '24' refer to the upper setpoint. This is true for all functions: low pressure controls, high pressure controls, manual or automatic reset types.

## Automatic reset

On pressure rise above the upper setpoint, contacts 1-2 (11-12; 21-22) open and contacts 1-4 (11-14, 21-24) close. On decreasing pressure below lower setpoint contacts 1-4 (11-14; 21-24) open and contacts 1-2 (11-12; 21-22) close.

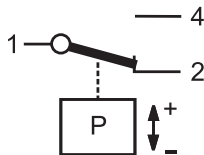

## Manual reset low pressure

On decreasing pressure below the lower setpoint, contacts 1-4 open, contacts 1-2 close and latch. On pressure rise above fixed differential per Selection Table and after pressing the manual reset button, contacts 1-2 will open and contacts 1-4 will close again.

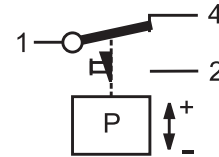

## Manual reset high pressure

On increasing pressure above the upper setpoint, contacts 1-2 open, contacts 1-4 close and latch. On falling pressure below fixed differential per Selection Table and after pressing the manual reset button, contacts 1-4 will open and contacts 1-2 will close again.

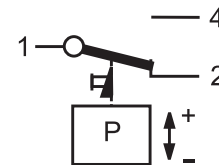

For operational safety, all PS1 / PS2 with manual reset are designed as *trip-free* controls, i.e. pressing the manual reset button while the pressure has not reached its reset threshold will not operate the electrical contacts.

## Installation and maintenance

A front access manual toggle is provided for checking out control operation. On low pressure controls this toggle may be used to override the low pressure signal during system evacuation, avoiding the need to undo the electrical wiring for this purpose.

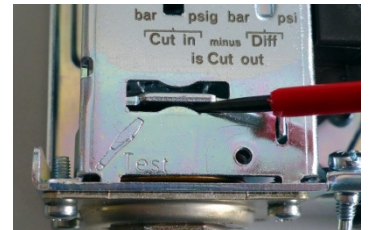

The standard mounting holes for mounting brackets are equipped with a universal thread to fit both, M4 and UNC 8-32 screws.



The standard wholesale package includes two mounting screws and a locking plate. Several hole patterns for surface mounting are provided, see physical dimensions.

# Pressure Controls PS1 / PS2 Series

## Physical Dimensions (mm)

PS1

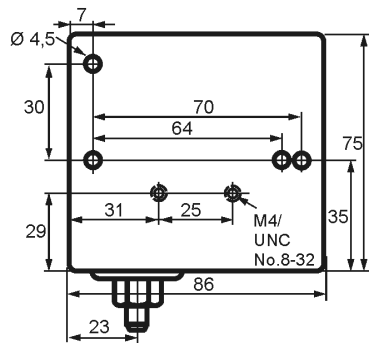

PS2

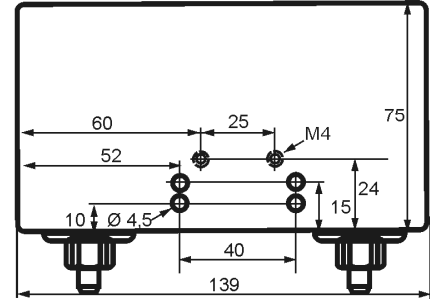

## Pressure Connections:

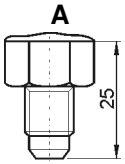

7/16" -20 UNF male (1/4" SAE)

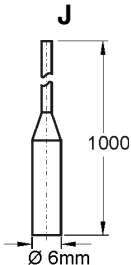

Capillary Tube with  $\varnothing$  6 mm ODM Solder Tube

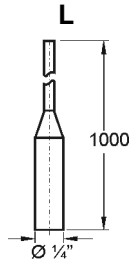

Capillary Tube with  $\varnothing$  1/4" ODM Solder Tube

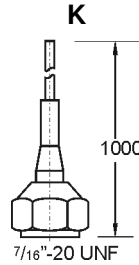

Capillary Tube with Flare Nut + Schrader depressor

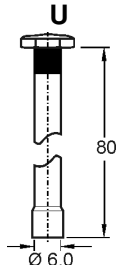

$\varnothing$  6 mm ODF Solder Tube

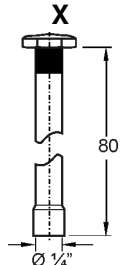

1/4" ODF Solder Tube

## Accessories

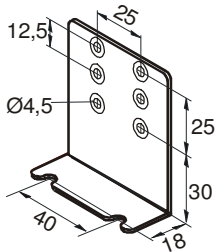

Mounting bracket angle  
0 714 144  
(incl. screws)

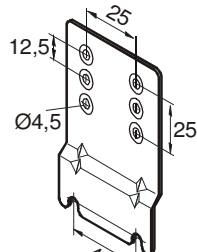

Mounting plate for units with hood  
0 714 145  
(incl. screws)



Locking Plate (20 pieces)  
803 783

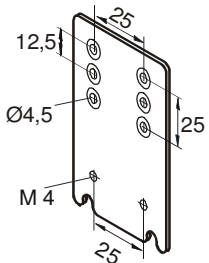

Extension bracket  
0 714 146  
(incl. screws)

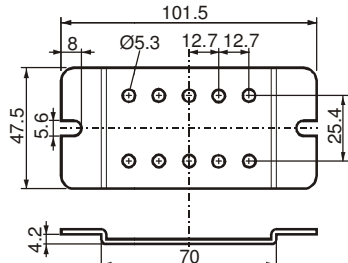

Horizontal mounting bracket  
0 716 063  
(incl. screws)

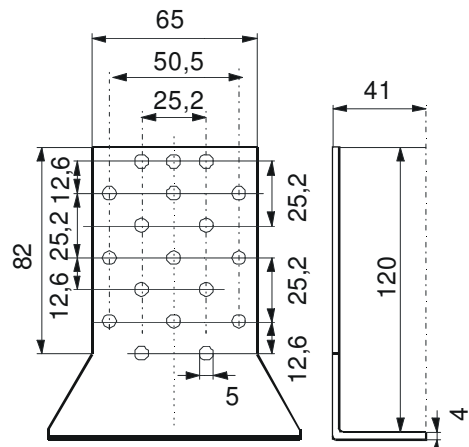

Univ. mounting bracket  
0 714 147  
(incl. screws)

26.02.2014 - Pressure Controls PS1 / PS2 Series

Emerson Climate Technologies GmbH shall not be liable for errors in the stated capacities, dimensions, etc., as well as typographic errors. Products, specifications, designs and technical data contained in this document are subject to modification by us without prior notice. Illustrations are not binding. The Emerson Climate Technologies logo is a trademark and service mark of Emerson Electric Co. Emerson Climate Technologies Inc. is a subsidiary of Emerson Electric Co.

EMERSON. CONSIDER IT SOLVED.