





VALVE HEAD W9 TYPE H

ART. NO. 600041

GENERAL

-  The KEOFIT CLASSIC W9 Sampling Valve is the original and leading sterilizable sampling valve in the world. Used in all industries for decades. More than 320 standard valve configurations. Unique serial no. for each valve*.
-  The sampling valve can be used for any process sampling for microbiological, chemical and/or physical analysis.
-  **Cleaning/sterilizing:** Between batches: Valve in open position: Cleanable by means of CIP using the detergent solution suitable for the actual process media. Between samples: Valve in its normal closed position: cleanable by CIP as "Between batches" or the valve may be sterilized by means of steam SIP or chemical SIP using a procedure appropriate to the actual circumstances. For further advice, please contact Keofitt.
Not recommended for autoclave due to plastic parts.
-  Designed for sampling of liquids with a viscosity of up to approx. 1.000 cP containing no particles larger than Ø3 mm. Sampling of more viscous liquids is possible, only will it take longer (depending on process pressure).

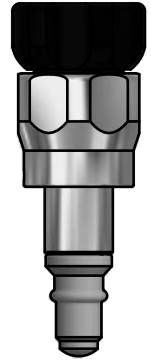

FEATURES

-  Installation: Threaded socket connection M22x1,5
-  Operation: Turn knob - spring loaded (opens clockwise)
-  Membrane: Silicone (#600051)

CERTIFICATION*

- EU EC 1935/2004 · EU EC 2023/2006 · DK No.822 06/2013 · 3-A Certificate · ATEX 94/9/EC & 2014/34/EU
- PED 2014/68/EU · FDA CFR 21 §177.2600 · USP Class VI · Keofitt DoC

TECHNICAL DATA

Material (product contact)

- Membrane SILICONE, GREY (#600051)

Material (without product contact)

- Steel parts AISI 303 (1.4305) / AISI 316L (1.4404)
- Knob PA6 (Black)

Membrane

- Article SILICONE, GREY (#600051)
- Certification* · EU EC 1935/2004 · EU EC 2023/2006 · DK No.822 06/2013 · FDA CFR 21 §177.2600 · USP Class VI · REACH · RoHS · ADI Free · Keofitt DoC

Pressure & Temperature

- Pressure 0 - 6 bar / 0 - 87 psi
- Temperature 1 - 130°C / 34 - 266°F
- Air supply -

Net Weight







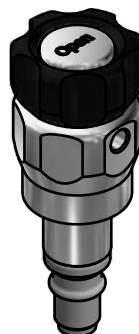
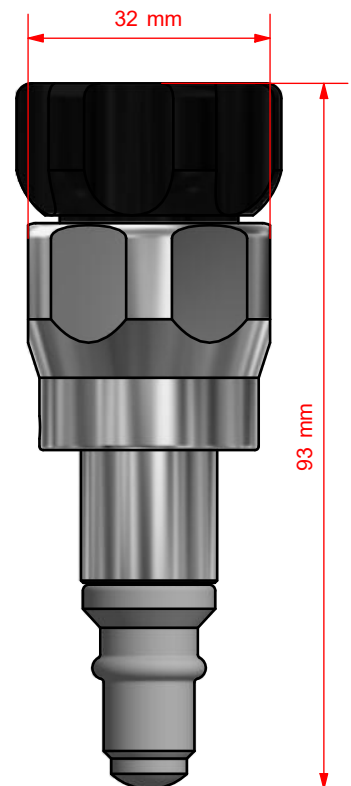















- kg/lbs 0.228 kg/0.501 lbs

Spareparts

- 776041 PARTS FOR W9 HEAD 600041/42/43/47



KEOFITT CLASSIC W9 SAMPLING VALVE - BODIES

		Welding bodies						Connection bodies					
		Tank Welding Ø28	Pipe Welding 1"	Pipe Welding NW25	In-Line Vertical	In-Line Horizontal	Varivent Ø50	Varivent Ø68	Clamp ½"	Clamp 1"	Clamp 2"	Thread	
W9 BODIES	Hose Piece	 850001	 850011	 850014	 850027*	 850028*	 850008	 850009	 850036	 850021	 850003	 850031 DIN 11851 850040	
	Mini Tri-Clamp	 850006	 850010	<i>On request</i>	<i>On request</i>	<i>On request</i>	<i>On request</i>	 850013	 850039	 850022 850025	 850026 850005	<i>On request</i>	
	Thread M16x1,5	 850015	 850016	 850018	<i>On request</i>	<i>On request</i>	<i>On request</i>	<i>On request</i>	<i>On request</i>	 850024	<i>On request</i>	<i>On request</i>	<i>On request</i>
	Welding Ends	 850007	 850019	<i>On request</i>	<i>On request</i>	<i>On request</i>	<i>On request</i>	<i>On request</i>	<i>On request</i>	<i>On request</i>	<i>On request</i>	<i>On request</i>	<i>On request</i>

* ON REQUEST ONLY!