



# Cilindrici Cylindrical

Fusibili cilindrici industriali - tipo gG <i>Industrial cylindrical fuses - gG type</i>	66
Fusibili cilindrici industriali - tipo aM <i>Industrial cylindrical fuses - aM type</i>	67
Fusibili cilindrici industriali - tipo extrarapido aR/gR <i>Industrial cylindrical fuses - high speed aR/gR type</i>	68
Portafusibili sezionabili serie "BCH" <i>Modular fuseholders series "BCH"</i>	70
Portafusibili sezionabili serie "DCH" <i>Modular fuseholders series "DCH"</i>	71
Accessori per portafusibili sezionabili serie "BCH" e "DCH" <i>Accessories for modular fuseholders series "BCH" and "DCH"</i>	72
Portafusibili sezionabili serie "PCF" e portafusibili da pannello <i>Modular fuseholders series "PCF" and panel fuseholders</i>	73
Pinze portafusibili ed accessori <i>Fuse clips and accessories</i>	74
Fusibili cilindrici civili - tipo gG <i>Cylindrical fuses for building applications - gG type</i>	75
Dimensioni e caratteristiche tecniche <i>Dimensions and technical specifications</i>	76

# FUSIBILI CILINDRICI INDUSTRIALI SERIE "CH"- "SCH"- "CH/P" - TIPO gG

## INDUSTRIAL CYLINDRICAL FUSES SERIES "CH"- "SCH"- "CHIP" - gG TYPE

Norme - Standards CEI 32-1, CEI 32-4, IEC EN 60269-1, IEC EN 60269-2

I fusibili cilindrici industriali di tipo gG sono normalmente utilizzati per la protezione di cavi, linee elettriche e apparecchiature contro i sovraccarichi ed i cortocircuiti. Il corpo di tali fusibili è realizzato in steatite, un materiale che consente di ottenere una elevata capacità di rottura in uno spazio fisico ridotto. L'elemento fusibile interno è appositamente progettato in modo da evitarne l'invecchiamento e mantenere inalterabili le caratteristiche elettriche. I contatti sono realizzati in rame argentato. Sono disponibili versioni con un indicatore visivo di fusione o con un percussore per l'uso in combinazione con portafusibili dotati di microinterruttore.

The industrial cylindrical fuses of gG type are normally used to protect cables, electrical lines and equipments against overloads and short circuits. The body of these fuses is made by steatite, a material which allows to obtain a high breaking capacity in a minimum physical space. The internal fuse element is specially designed to prevent aging and to maintain the electrical characteristics unchanged. The contacts are made by silver-plated copper. Special versions are available with a visual indicator or with a striker to be used in combination with fuseholders with microswitch.



Fusibile CH10 gG standard  
CH10 gG fuse standard



Fusibile SCH14 gG con indicatore di fusione  
SCH14 gG fuse with blown fuse indicator



Fusibile CH/P22 gG con percussore  
CH/P22 gG fuse with striker

### FUSIBILI CH, SCH, CH/P - TIPO gG SERIES CH, SCH, CHIP FUSES - gG TYPE

grandezza size	codice IW - IW code			I <sub>n</sub> (A) I <sub>n</sub> (A)	V <sub>n</sub> (V) V <sub>n</sub> (V)	conf. pack.
	CH standard CH standard	SCH con indicatore di fusione SCH with blown fuse indicator	CH/P con percussore CHIP with striker			
CH8 (8,5x31,5)	1411001	-	-	1A	400V	10-100
	1411002	-	-	2A	400V	10-100
	1411004	1411904	-	4A	400V	10-100
	1411006	1411906	-	6A	400V	10-100
	1411008	1411908	-	8A	400V	10-100
	1411010	1411910	-	10A	400V	10-100
	1411012	1411912	-	12A	400V	10-100
	1411016	1411916	-	16A	400V	10-100
	1411020	1411920	-	20A	400V	10-100
	1411025	-	-	25A	400V	10-100
	CH10, SCH10 (10,3x38)	1421000	-	-	0,5A	500V
1421001		-	-	1A	500V	10-100
1421002		1421902	-	2A	500V	10-100
1421004		1421904	-	4A	500V	10-100
1421006		1421906	-	6A	500V	10-100
1421008		1421908	-	8A	500V	10-100
1421010		1421910	-	10A	500V	10-100
1421012		1421912	-	12A	500V	10-100
1421016		1421916	-	16A	500V	10-100
1421020		1421920	-	20A	500V	10-100
1421025		1421925	-	25A	500V	10-100
CH14, SCH14, CH/P14 (14x51)	1431001	-	-	1A	690V	10-50
	1431002	1431902	1433002 <sup>(1)</sup>	2A	690V	10-50
	1431004	1431904	1433004 <sup>(1)</sup>	4A	690V	10-50
	1431006	1431906	1433006 <sup>(1)</sup>	6A	690V	10-50
	1431008	1431908	1433008 <sup>(1)</sup>	8A	690V	10-50
	1431010	1431910	1433010 <sup>(1)</sup>	10A	690V	10-50
	1431012	1431912	1433012 <sup>(1)</sup>	12A	690V	10-50
	1431016	1431916	1433016 <sup>(1)</sup>	16A	690V	10-50
	1431020	1431920	1433020 <sup>(1)</sup>	20A	690V	10-50
	1431025	1431925	1433025 <sup>(1)</sup>	25A	690V	10-50
	1431032	1431932	1433032	32A	500V	10-50
CH22, SCH22, CH/P22 (22x58)	1441004	1441904	1443004	4A	690V	10-50
	1441006	1441906	1443006	6A	690V	10-50
	1441008	1441908	1443008	8A	690V	10-50
	1441010	1441910	1443010	10A	690V	10-50
	1441012	1441912	1443012	12A	690V	10-50
	1441016	1441916	1443016	16A	690V	10-50
	1441020	1441920	1443020	20A	690V	10-50
	1441025	1441925	1443025	25A	690V	10-50
	1441032	1441932	1443032	32A	690V	10-50
	1441040	1441940	1443040	40A	690V	10-50
	1441050	1441950	1443050	50A	690V	10-50
1441063	1441963	1443063	63A	690V	10-50	
1441080	1441980	1443080	80A	500V	10-50	
1441099	1441999	1443100	100A	500V	10-50	
1441100	1442000	1443125	125A	400V	10-50	

(1) Modello a 500V

(1) 500V version

# FUSIBILI CILINDRICI INDUSTRIALI SERIE "CH"- "SCH"- "CH/P" - TIPO aM

## INDUSTRIAL CYLINDRICAL FUSES SERIES "CH"- "SCH"- "CHIP" - aM TYPE

Norme - Standards CEI 32-1, CEI 32-4, IEC EN 60269-1, IEC EN 60269-2

I fusibili cilindrici industriali di tipo aM sono normalmente utilizzati per la protezione di motori, trasformatori e di tutte quelle apparecchiature che presentano uno spunto di corrente all'avvio. Questi fusibili sono utilizzati per la protezione contro i cortocircuiti e sono abbinati ad altri dispositivi per la protezione dai sovraccarichi. Il corpo è realizzato in steatite. L'elemento fusibile è progettato in modo da evitarne l'invecchiamento e mantenere inalterabili le caratteristiche elettriche. I contatti sono realizzati in rame argentato. Sono disponibili versioni con un indicatore visivo di fusione o con un percussore per l'uso in combinazione con portafusibili dotati di microinterruttore.

The industrial cylindrical fuses of aM type are normally used to protect motors, transformers and all those equipments who present an inrush current at the startup. They are used for short circuits protection and should be associated to another device for overload protection. The body of these fuses is made by steatite. The internal fuse element is designed to prevent aging and to maintain the electrical characteristics unchanged. The contacts are made by silver-plated copper. Special versions are available with a visual indicator or with a striker to be used in combination with fuseholders with microswitch.



Fusibile CH10 aM standard  
CH10 aM fuse standard



Fusibile SCH14 aM con indicatore di fusione  
SCH14 aM fuse with blown fuse indicator



Fusibile CH/P22 aM con percussore  
CHIP22 aM fuse with striker

### FUSIBILI CH, SCH, CH/P - TIPO aM SERIES CH, SCH, CHIP FUSES - aM TYPE

grandezza size	codice IW - IW code			I <sub>n</sub> (A) I <sub>n</sub> (A)	V <sub>n</sub> (V) V <sub>n</sub> (V)	conf. pack.
	CH standard CH standard	SCH con indicatore di fusione SCH with blown fuse indicator	CH/P con percussore CHIP with striker			
CH8 (8,5x31,5)	1412001	1412901	—	1A	400V	10-100
	1412002	1412902	—	2A	400V	10-100
	1412004	1412904	—	4A	400V	10-100
	1412006	1412906	—	6A	400V	10-100
	1412008	—	—	8A	400V	10-100
	1412010	1412910	—	10A	400V	10-100
CH10, SCH10 (10,3x38)	1422160	—	—	0,16A	500V	10-100
	1422250	—	—	0,25A	500V	10-100
	1422000	—	—	0,5A	500V	10-100
	1422001	1422901	—	1A	500V	10-100
	1422002	1422902	—	2A	500V	10-100
	1422004	1422904	—	4A	500V	10-100
	1422006	1422906	—	6A	500V	10-100
	1422008	1422908	—	8A	500V	10-100
	1422010	1422910	—	10A	500V	10-100
	1422012	1422912	—	12A	500V	10-100
	1422016	1422916	—	16A	500V	10-100
	1422020	1422920	—	20A	400V	10-100
	1422025	1422925	—	25A	400V	10-100
	1422032	—	—	32A	400V	10-100
CH14, SCH14, CH/P14 (14x51)	1432001	—	—	1A	690V	10-50
	1432002	1432902	1433902 <sup>(1)</sup>	2A	690V	10-50
	1432004	1432904	1433904 <sup>(1)</sup>	4A	690V	10-50
	1432006	1432906	1433906 <sup>(1)</sup>	6A	690V	10-50
	1432008	1432908	1433908 <sup>(1)</sup>	8A	690V	10-50
	1432010	1432910	1433910 <sup>(1)</sup>	10A	690V	10-50
	1432012	1432912	1433912 <sup>(1)</sup>	12A	690V	10-50
	1432016	1432916	1433916 <sup>(1)</sup>	16A	690V	10-50
	1432020	1432920	1433920 <sup>(1)</sup>	20A	690V	10-50
	1432025	1432925	1433925 <sup>(1)</sup>	25A	690V	10-50
	1432032	1432932	1433932	32A	500V	10-50
	1432040	1432940	1433940	40A	500V	10-50
	1432050	1432950	1433950	50A	400V	10-50
	CH22, SCH22, CH/P22 (22x58)	1442004	1442904	1443904	4A	690V
1442006		1442906	1443906	6A	690V	10-50
1442008		1442908	1443908	8A	690V	10-50
1442010		1442910	1443910	10A	690V	10-50
1442012		1442912	1443912	12A	690V	10-50
1442016		1442916	1443916	16A	690V	10-50
1442020		1442920	1443920	20A	690V	10-50
1442025		1442925	1443925	25A	690V	10-50
1442032		1442932	1443932	32A	690V	10-50
1442040		1442940	1443940	40A	690V	10-50
1442050		1442950	1443950	50A	690V	10-50
1442063		1442963	1443963	63A	690V	10-50
1442080		1442980	1443980	80A	500V	10-50
1442099		1442999	1443990	100A	500V	10-50
1442100	1443000	1443999	125A	400V	10-50	

(1) Modello a 500V

(1) 500V version

CILINDRICI  
CYLINDRICAL

# FUSIBILI CILINDRICI INDUSTRIALI SERIE "CH"- "CH/P"- "AQS-F" - TIPO aR/gR

## INDUSTRIAL CYLINDRICAL FUSES SERIES "CH"- "CHIP"- "AQS-F" - aR/gR TYPE

Norme - Standards CEI 32-1, CEI 32-7, IEC EN 60269-1, IEC EN 60269-4, UL 248-13

Il corpo dei fusibili del tipo aR e gR è realizzato in steatite, mentre i contatti sono in rame argentato. La caratteristica di intervento di tipo extrarapido, l'elevato potere di interruzione ed i bassi valori dell'energia specifica passante ( $I^2t$ ) rendono questi fusibili indicati per la protezione di apparecchiature che contengono semiconduttori (inverter, UPS, soft starters, ecc). I fusibili aR proteggono le apparecchiature dai cortocircuiti, mentre i fusibili gR forniscono una protezione completa, dai cortocircuiti e dai sovraccarichi. Visti gli elevati valori di potenza dissipata, occorre verificare la compatibilità del loro utilizzo all'interno dei relativi portafusibili.

The body of the fuses type gR and aR is made by steatite, while the contacts are made by silver-plated copper. The high speed tripping characteristic, the high breaking capacity and low values of the let-through energy ( $I^2t$ ) make these fuses suitable for the protection of any type of equipment that contains semiconductors, (inverters, UPS, soft starters, etc). In particular, the aR fuses protect equipment from short circuits, while gR fuses provide complete protection from short circuits and overloads. Given the high values of power dissipation, it is necessary to check their compatibility within the fuseholders.



Fusibile CH10 aR standard  
CH10 aR fuse standard



Fusibile CH/P22 aR con percussore  
CHIP22 aR fuse with striker

### FUSIBILI EXTRARAPIDI CH, CH/P, AQS-F - TIPO aR/gR SERIES CH, CHIP, AQS-F HIGH SPEED FUSES - aR/gR TYPE

grandezza size	codice IW - IW code			$I_n$ (A) $I_n$ (A)	$V_n$ (V) $V_n$ (V)	conf. pack.
	CH standard (aR) CH standard (aR)	CH/P con percussore (aR) CHIP with striker (aR)	AQS-F <sup>(1)</sup> omologazione UR (gR) AQS-F <sup>(1)</sup> UR approval (gR)			
CH10 (10,3x38)	-	-	1485010 <sup>(2)</sup>	1A	600V	10-100
	-	-	1485013 <sup>(2)</sup>	2A	600V	10-100
	1460004	-	1485016 <sup>(2)</sup>	4A	600V	10-100
	1460006	-	1485018 <sup>(2)</sup>	6A	600V	10-100
	1460008	-	1485019 <sup>(2)</sup>	8A	600V	10-100
	1460010	-	1485020 <sup>(2)</sup>	10A	600V	10-100
	1460012	-	1485021 <sup>(2)</sup>	12A	600V	10-100
	1460016	-	1485022 <sup>(2)</sup>	16A	600V	10-100
	1460020	-	1485023 <sup>(2)</sup>	20A	600V	10-100
	1460025	-	1485024 <sup>(2)</sup>	25A	600V	10-100
	-	-	1485025 <sup>(2)</sup>	30A	600V	10-100
	1460032	-	-	32A	600V	10-100
	CH14, CH/P14 (14x51)	-	-	1480006	6A	690V
-		-	1480008	8A	690V	10-50
1461010		1471010	1480010	10A	690V	10-50
1461012		1471012	1480012	12A	690V	10-50
1461016		1471016	1480016	16A	690V	10-50
1461020		1471020	1480020	20A	690V	10-50
1461025		1471025	1480025	25A	690V	10-50
1461032		1471032	1480032	32A	690V	10-50
1461040		1471040	1480040 <sup>(2)</sup>	40A	600V	10-50
1461050		1471050	1480050 <sup>(2)</sup>	50A	500V	10-50
CH22, CH/P22 (22x58)	1462020	1472020	1482020	20A	690V	10-50
	1462025	1472025	1482025	25A	690V	10-50
	1462032	1472032	1482032	32A	690V	10-50
	1462040	1472040	1482040	40A	690V	10-50
	1462050	1472050	1482050	50A	690V	10-50
	1462063	1472063	1482063	63A	690V	10-50
	1462080	1472080	1482080 <sup>(2)</sup>	80A	600V	10-50
1462100	1472100	1482100 <sup>(2)</sup>	100A	500V	10-50	

(1) Omologazione UR a 700V

(2) Modello a 690V

(1) UR approval at 700V

(2) 690V version

# FUSIBILI CILINDRICI INDUSTRIALI SERIE "FWC"- "FWP" - TIPO aR

## INDUSTRIAL CYLINDRICAL FUSES SERIES "FWC"- "FWP" - aR TYPE

Norme - Standards CEI 32-1, CEI 32-7, IEC EN 60269-1, IEC EN 60269-4, UL 248-13

Il corpo dei fusibili del tipo aR è realizzato in steatite, mentre i contatti sono in rame argentato. La caratteristica di intervento di tipo extrarapido, l'elevato potere di interruzione ed i bassi valori dell'energia specifica passante ( $I^2t$ ) rendono questi fusibili particolarmente indicati per la protezione dai cortocircuiti di qualunque tipo di apparecchiatura che contenga semiconduttori, ad esempio inverter, motor drives, UPS, soft starters, ecc. Visti gli elevati valori di potenza dissipata da tali fusibili, occorre verificare la compatibilità del loro utilizzo all'interno dei relativi portafusibili.

The body of the aR type fuses is made by steatite, while the contacts are made by silver-plated copper. The high speed tripping characteristic, the high breaking capacity and low values of the let-through energy ( $I^2t$ ) make these fuses particularly suitable for the protection from short circuits of any type of equipment that contains semiconductors, for example, inverters, motor drives, UPS, soft starters, etc. Given the high values of power dissipation of these fuses it is necessary to check the compatibility of their use within the fuseholders.



Fusibile FWC-10A 10F  
FWC-10A 10F fuse



Fusibile FWP-63A 22F  
FWP-63A 22F fuse

### FUSIBILI EXTRARAPIDI - SERIE FWC E FWP - TIPO aR - CON OMOLOGAZIONE

HIGH SPEED FUSES SERIES FWC AND FWP - aR TYPE -  APPROVED

grandezza size	codice IW IW code	descrizione description	$I_n$ (A) $I_n$ (A)	$V_n$ (V) $V_n$ (V)	conf. pack.
10,3x38	1774006	FWC-6A 10F	6A	600V	10
	1774008	FWC-8A 10F	8A	600V	10
	1774010	FWC-10A 10F	10A	600V	10
	1774012	FWC-12A 10F	12A	600V	10
	1774015	FWC-16A 10F	16A	600V	10
	1774020	FWC-20A 10F	20A	600V	10
	1774025	FWC-25A 10F	25A	600V	10
	1774032	FWC-32A 10F	32A	600V	10
14x51	1489001	FWP-1A 14F	1A	700V	10
	1489002	FWP-2A 14F	2A	700V	10
	1489003	FWP-3A 14F	3A	700V	10
	1489004	FWP-4A 14F	4A	700V	10
	1489005	FWP-5A 14F	5A	700V	10
	1489010	FWP-10A 14F	10A	700V	10
	1489015	FWP-15A 14F	15A	700V	10
	1489020	FWP-20A 14F	20A	700V	10
	1489025	FWP-25A 14F	25A	700V	10
	1489030	FWP-30A 14F	30A	700V	10
	1489032	FWP-32A 14F	32A	700V	10
	1489040	FWP-40A 14F	40A	700V	10
1489050	FWP-50A 14F	50A	700V	10	
22x58	1777020	FWP-20A 22F	20A	700V	10
	1777025	FWP-25A 22F	25A	700V	10
	1777032	FWP-32A 22F	32A	700V	10
	1777040	FWP-40A 22F	40A	700V	10
	1777050	FWP-50A 22F	50A	700V	10
	1777063	FWP-63A 22F	63A	700V	10
	1777080	FWP-80A 22F	80A	700V	10
	1777100	FWP-100A 22F	100A	700V	10

CILINDRICI  
CYLINDRICAL

# FUSIBILI CILINDRICI INDUSTRIALI PORTAFUSIBILI SEZIONABILI SERIE "BCH"

## INDUSTRIAL CYLINDRICAL FUSES SERIES "BCH" MODULAR FUSEHOLDERS

Norme - Standards IEC EN 60269-1, IEC EN 60269-2, IEC EN 60947-3, VDE 0636

I portafusibili della serie BCH sono realizzati tenendo conto delle più recenti tecnologie. Il corpo è realizzato in materiali termoplastici autoestinguenti e resistenti alle elevate temperature, mentre i contatti sono in rame argentato. Tutti i portafusibili sono piombabili. La versione con LED fornisce una indicazione visiva dell'avvenuto intervento del fusibile, mentre la versione con microinterruttore fornisce una segnalazione a distanza dell'intervento del fusibile (che dovrà essere dotato di percussore), dell'apertura della maniglia e della mancanza dei fusibili. I fusibili devono essere ordinati separatamente.

The fuseholders of the BCH series are made taking into account the best latest technologies. The body is made of thermoplastic self-extinguishing and resistant to high temperatures materials, while its contacts are made by silver-plated copper. All fuseholders are sealable. The version with LED provides a visual indication of the operation of the fuse while the version with microswitch provides a remote indication of the intervention of the fuse (that must be of the type with striker), of the handle opening and of the lack of fuses. The fuses must be ordered separately.



Portafusibile BCH 1x38  
BCH 1x38 modular fuseholder

### BCH 38 - PORTAFUSIBILI SEZIONABILI (AC-22B) PER FUSIBILI CILINDRICI 10,3x38 BCH 38 - MODULAR FUSEHOLDERS (AC-22B) FOR 10,3x38 CYLINDRICAL FUSES

codice IW IW code	tipo type	n. poli poles	n. moduli 17,5 mm no. 17,5 mm modules	indicatore luminoso indicator light	micro microswitch	I <sub>n</sub> (A) I <sub>n</sub> (A)	V <sub>n</sub> (V) V <sub>n</sub> (V)	conf. pack.
2301038	BCH 1x38	1P	1	–	–	32A	690V	12-240
2304138	SBCH 1x38	1P	1	X	–	32A	690V	12-240
2301137	NBCH 1x38	1P+N	1	–	–	32A	690V	12-240
2301138	BCH 1x38N	1P+N	2	–	–	32A	690V	6-120
2302038	BCH 2x38	2P	2	–	–	32A	690V	6-120
2303038	BCH 3x38	3P	3	–	–	32A	690V	4-80
2304338	SBCH 3x38	3P	3	X	–	32A	690V	4-80
2303137	NBCH 3x38	3P+N	3	–	–	32A	690V	4-80
2303138	BCH 3x38N	3P+N	4	–	–	32A	690V	3-60

Omologazione (UL) (SE) esclusi i tipi NBCH 1x38 e NBCH 3x38  
(per questi tipi la categoria d'impiego è AC-20B)

(UL) (SE) approval except types NBCH 1x38 and NBCH 3x38  
(for these types the utilization category is AC-20B)



Portafusibile BCH 1x51  
BCH 1x51 modular fuseholder

### BCH 51 - PORTAFUSIBILI SEZIONABILI (AC-22B) PER FUSIBILI CILINDRICI 14x51 BCH 51 - MODULAR FUSEHOLDERS (AC-22B) FOR 14x51 CYLINDRICAL FUSES

codice IW IW code	tipo type	n. poli poles	n. moduli 17,5 mm no. 17,5 mm modules	indicatore luminoso indicator light	micro microswitch	I <sub>n</sub> (A) I <sub>n</sub> (A)	V <sub>n</sub> (V) V <sub>n</sub> (V)	conf. pack.
2301051	BCH 1x51	1P	1,5	–	–	50A	690V	6-72
2304151	SBCH 1x51	1P	1,5	X	–	50A	690V	6-72
2305051	BCH/P 1x51 <sup>(1)</sup>	1P	1,5	–	X	50A	690V	6-72
2301151	BCH 1x51N	1P+N	3	–	–	50A	690V	3-36
2302051	BCH 2x51	2P	3	–	–	50A	690V	3-36
2303051	BCH 3x51	3P	4,5	–	–	50A	690V	2-24
2304351	SBCH 3x51	3P	4,5	X	–	50A	690V	2-24
2305351	BCH/P 3x51 <sup>(1)</sup>	3P	4,5	–	X	50A	690V	2-24
2303151	BCH 3x51N	3P+N	6	–	–	50A	690V	1-12

Omologazione (UL) (SE) (1) Per fusibili CH/P14 con percussore

(UL) (SE) approval (1) Fuses CHIP14 with striker must be used



Portafusibile BCH 1x58  
BCH 1x58 modular fuseholder

### BCH 58 - PORTAFUSIBILI SEZIONABILI (AC-20B) PER FUSIBILI CILINDRICI 22x58 BCH 58 - MODULAR FUSEHOLDERS (AC-20B) FOR 22x58 CYLINDRICAL FUSES

codice IW IW code	tipo type	n. poli poles	n. moduli 17,5 mm no. 17,5 mm modules	indicatore luminoso indicator light	micro microswitch	I <sub>n</sub> (A) I <sub>n</sub> (A)	V <sub>n</sub> (V) V <sub>n</sub> (V)	conf. pack.
2301058	BCH 1x58	1P	2	–	–	100A	690V	6-48
2304158	SBCH 1x58	1P	2	X	–	100A	690V	6-48
2305058	BCH/P 1x58 <sup>(1)</sup>	1P	2	–	X	100A	690V	6-48
2301158	BCH 1x58N	1P+N	4	–	–	100A	690V	3-24
2302058	BCH 2x58	2P	4	–	–	100A	690V	3-24
2303058	BCH 3x58	3P	6	–	–	100A	690V	2-16
2304358	SBCH 3x58	3P	6	X	–	100A	690V	2-16
2305358	BCH/P 3x58 <sup>(1)</sup>	3P	6	–	X	100A	690V	2-16
2303158	BCH 3x58N	3P+N	8	–	–	100A	690V	1-8

Omologazione (UL) (SE) (1) Per fusibili CH/P22 con percussore

(UL) (SE) approval (1) Fuses CHIP22 with striker must be used

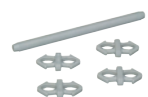

Kit spine accoppiamento  
Kit of assembling pins

### SPINETTE DI ACCOPIAMENTO ASSEMBLY PINS

codice IW IW code	per portafus. for fuseholders	kit per accoppiamento n. poli kit for no. poles assembling	n. spine per leva frontale no. pins for front handle	n. spine per corpo portafusibile no. pins for fuseholder body	conf. pack.
2398001	BCH 38	2	10	30	1 kit
2398002	BCH 38	3	10	60	1 kit
2398003	BCH 51	2	10	30	1 kit
2398004	BCH 51	3	10	60	1 kit
2398005	BCH 58	2	10	30	1 kit
2398006	BCH 58	3	10	60	1 kit

# FUSIBILI CILINDRICI INDUSTRIALI PORTAFUSIBILI SEZIONABILI SERIE "DCH"

## INDUSTRIAL CYLINDRICAL FUSES SERIES "DCH" MODULAR FUSEHOLDERS

Norme - Standards IEC EN 60269-1, IEC EN 60269-2, IEC EN 60947-3, VDE 0636

I portafusibili della serie DCH sono realizzati tenendo conto delle più recenti tecnologie, al fine di garantire la massima qualità ed affidabilità del loro utilizzo. Il corpo si presenta con un design moderno ed è realizzato in materiali termoplastici autoestinguenti e resistenti alle elevate temperature, mentre i contatti sono in rame argentato. Tutti i portafusibili sono piombabili per la sicurezza degli operatori durante le operazioni di manutenzione. La versione con LED fornisce una indicazione visiva dell'avenuto intervento del fusibile, mentre la versione con microinterruttore fornisce una segnalazione a distanza dell'intervento del fusibile. I fusibili devono essere ordinati separatamente.

The fuseholders of the DCH series are made taking into account the best latest technologies, in order to ensure the highest quality and reliability of their use. The body comes with a modern design and is made of thermoplastic self-extinguishing and resistant to high temperatures materials, while its contacts are made by silver-plated copper. All fuseholders are sealable for operator safety during maintenance operations. The version with LED provides a visual indication of the operation of the fuse while the version with microswitch provides a remote indication of the intervention of the fuse. The fuses must be ordered separately.



Portafusibile DCH 1x31  
DCH 1x31 modular fuseholder

### DCH 31 - PORTAFUSIBILI SEZIONABILI (AC-22B) PER FUSIBILI CILINDRICI 8,5x31,5 DCH 31 - MODULAR FUSEHOLDERS (AC-22B) FOR 8,5x31,5 CYLINDRICAL FUSES

codice IW IW code	tipo type	n. poli poles	n. moduli 17,5 mm no. 17,5 mm modules	indicatore luminoso indicator light	micro microswitch	I <sub>n</sub> (A) I <sub>n</sub> (A)	V <sub>n</sub> (V) V <sub>n</sub> (V)	conf. pack.
2341031	DCH 1x31	1P	1	-	-	20A	400V	12-108
2341131	DCH 1x31N	1P+N	2	-	-	20A	400V	6-54
2342031	DCH 2x31	2P	2	-	-	20A	400V	6-54
2343031	DCH 3x31	3P	3	-	-	20A	400V	4-36
2343131	DCH 3x31N	3P+N	4	-	-	20A	400V	3-27



Portafusibile DCH 1x38  
DCH 1x38 modular fuseholder

### DCH 38 - PORTAFUSIBILI SEZIONABILI (AC-22B) PER FUSIBILI CILINDRICI 10,3x38 CON OMOLOGAZIONE DCH 38 - MODULAR FUSEHOLDERS (AC-22B) FOR 10,3x38 CYLINDRICAL FUSES - APPROVED

codice IW IW code	tipo type	n. poli poles	n. moduli 17,5 mm no. 17,5 mm modules	indicatore luminoso indicator light	micro microswitch	I <sub>n</sub> (A) I <sub>n</sub> (A)	V <sub>n</sub> (V) V <sub>n</sub> (V)	conf. pack.
2341038	DCH 1x38	1P	1	-	-	32A	690V	12-108
2344138	SDCH 1x38	1P	1	X	-	32A	690V	12-108
2341138	DCH 1x38N	1P+N	2	-	-	32A	690V	6-54
2342038	DCH 2x38	2P	2	-	-	32A	690V	6-54
2343038	DCH 3x38	3P	3	-	-	32A	690V	4-36
2344338	SDCH 3x38	3P	3	X	-	32A	690V	4-36
2343138	DCH 3x38N	3P+N	4	-	-	32A	690V	3-27



Portafusibile DCH 1x51  
DCH 1x51 modular fuseholder

### DCH 51 - PORTAFUSIBILI SEZIONABILI (AC-22B) PER FUSIBILI CILINDRICI 14x51 CON OMOLOGAZIONE DCH 51 - MODULAR FUSEHOLDERS (AC-22B) FOR 14x51 CYLINDRICAL FUSES - APPROVED

codice IW IW code	tipo type	n. poli poles	n. moduli 17,5 mm no. 17,5 mm modules	indicatore luminoso indicator light	micro microswitch	I <sub>n</sub> (A) I <sub>n</sub> (A)	V <sub>n</sub> (V) V <sub>n</sub> (V)	conf. pack.
2341051	DCH 1x51	1P	1,5	-	-	50A	690V	12-96
2344151	SDCH 1x51	1P	1,5	X	-	50A	690V	12-96
2341151	DCH 1x51N	1P+N	3	-	-	50A	690V	6-48
2342051	DCH 2x51	2P	3	-	-	50A	690V	6-48
2343051	DCH 3x51	3P	4,5	-	-	50A	690V	4-32
2344351	SDCH 3x51	3P	4,5	X	-	50A	690V	4-32
2343151	DCH 3x51N	3P+N	6	-	-	50A	690V	3-24



Portafusibile DCH 1x58  
DCH 1x58 modular fuseholder

### DCH 58 - PORTAFUSIBILI SEZIONABILI (AC-21B) PER FUSIBILI CILINDRICI 22x58 CON OMOLOGAZIONE DCH 58 - MODULAR FUSEHOLDERS (AC-21B) FOR 22x58 CYLINDRICAL FUSES - APPROVED

codice IW IW code	tipo type	n. poli poles	n. moduli 17,5 mm no. 17,5 mm modules	indicatore luminoso indicator light	micro microswitch	I <sub>n</sub> (A) I <sub>n</sub> (A)	V <sub>n</sub> (V) V <sub>n</sub> (V)	conf. pack.
2341058	DCH 1x58	1P	2	-	-	100A	690V	3-105
2344158	SDCH 1x58	1P	2	X	-	100A	690V	3-105
2341158	DCH 1x58N	1P+N	4	-	-	100A	690V	2-48
2342058	DCH 2x58	2P	4	-	-	100A	690V	2-48
2343058	DCH 3x58	3P	6	-	-	100A	690V	1-35
2344358	SDCH 3x58	3P	6	X	-	100A	690V	1-35
2343158	DCH 3x58N	3P+N	8	-	-	100A	690V	1-24



Kit spine accoppiamento  
Kit of assembling pins

### ACCESSORI ACCESSORIES

codice IW IW code	per portafus. for fuseholders	descrizione description	kit per accoppiamento n. poli kit for no. poles assembling	conf. pack.
2348001	DCH 31 / DCH 38	spinette di accoppiamento 2P - connection kit 2P	2	1 kit
2348002	DCH 31 / DCH 38	spinette di accoppiamento 3P - connection kit 3P	3	1 kit
2348003	DCH 51	spinette di accoppiamento 2P - connection kit 2P	2	1 kit
2348004	DCH 51	spinette di accoppiamento 3P - connection kit 3P	3	1 kit
2348005	DCH 58	spinette di accoppiamento 2P - connection kit 2P	2	1 kit
2348006	DCH 58	spinette di accoppiamento 3P - connection kit 3P	3	1 kit
2348009	DCH 51	contatto ausiliario - auxiliary switch	-	1 kit
2348010	DCH 58	contatto ausiliario - auxiliary switch	-	1 kit

1 kit di spinette di accoppiamento serve per assemblare 50 set

1 connection kit is used for assembling 50 sets

# FUSIBILI CILINDRICI INDUSTRIALI ACCESSORI PER PORTAFUSIBILI SEZIONABILI SERIE "BCH" / "DCH"

## INDUSTRIAL CYLINDRICAL FUSES ACCESSORIES FOR SERIES "BCH" / "DCH" MODULAR FUSEHOLDERS

Una ampia gamma di accessori garantisce la possibilità di utilizzare al meglio ed in ogni situazione applicativa i portafusibili della serie BCH / DCH.

Tale gamma comprende:

- varie tipologie di barre a pettine isolate;
- morsetti di connessione per barre a pettine isolate;
- tappi per barre a pettine isolate.

A wide range of accessories guarantees the best use of the BCH / DCH fuseholders in every possible application.

This range includes:

- various types of insulated busbars;
- connection clamps for insulated busbars;
- caps for insulated busbars.

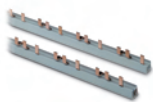

Barre a pettine isolate  
Insulated busbars

### BARRE A PETTINE ISOLATE 400V 400V INSULATED BUSBARS

codice IW IW code	tipo type	n. poli poles	passo pitch	per uso con use with	sezione section	lunghezza length	conf. pack.
<b>connessione a forcella - fork type connection</b>							
2306026	BP18 1P 16-G	1	18 mm	MCB 1 Mod.	16 mm <sup>2</sup>	981 mm	10
2306027	BP27 1P 20-G	1	27 mm	MCB 1,5 Mod.	20 mm <sup>2</sup>	985 mm	10
2306029	BP18 2P 16-G	2	18 mm	MCB 1 Mod.	16 mm <sup>2</sup>	1000 mm	10
2306030	BP18 3P 16-G	3	18 mm	MCB 1 Mod.	16 mm <sup>2</sup>	1014 mm	10
2306032	BP18 4P 16-G	4	18 mm	MCB 1 Mod.	16 mm <sup>2</sup>	1000 mm	10
<b>connessione a puntale - pin type connection</b>							
2306020	BP18 1P 16-S	1	18 mm	BCH / DCH 38	16 mm <sup>2</sup>	981 mm	10
2306022	BP27 1P 16-S	1	27 mm	BCH / DCH 51	16 mm <sup>2</sup>	981 mm	10
2306024	BP27 1P 35-S	1	27 mm	BCH / DCH 51	35 mm <sup>2</sup>	1000 mm	10
2306028	BP18 2P 16-S	2	18 mm	BCH / DCH 38	16 mm <sup>2</sup>	1000 mm	10
2306021	BP18 3P 16-S	3	18 mm	BCH / DCH 38	16 mm <sup>2</sup>	1012 mm	10
2306023	BP27 3P 16-S	3	27 mm	BCH / DCH 51	16 mm <sup>2</sup>	1045 mm	10
2306025	BP27 3P 30-S	3	27 mm	BCH / DCH 51	30 mm <sup>2</sup>	1000 mm	10
2306031	BP18 4P 16-S	4	18 mm	BCH / DCH 38	16 mm <sup>2</sup>	1000 mm	10



Morsetti di connessione  
Connections clamps

### MORSETTI DI CONNESSIONE A PUNTALE (PER BARRE A PETTINE ISOLATE) PIN CONNECTION CLAMPS (FOR INSULATED BUSBARS)

codice IW IW code	tipo type	lunghezza pin pin lenght	larghezza pin pin width	sezione morsetto clamp section	conf. pack.
<b>connessione laterale - side connection</b>					
2306050	L62513P	32 mm	4,3 mm	6÷25 mm <sup>2</sup>	50
2306052	L6501P	14 mm	4,1 mm	6÷50 mm <sup>2</sup>	25
2306053	L6503P	32 mm	7 mm	6÷50 mm <sup>2</sup>	25
<b>connessione frontale - front connection</b>					
2306051	F62513P	32 mm	4,3 mm	6÷25 mm <sup>2</sup>	50
2306054	F6503P	14 mm	4,1 mm	6÷50 mm <sup>2</sup>	25

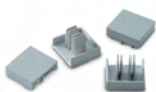

Tappi per barre a pettine  
Caps for insulated busbars

### TAPPI (PER BARRE A PETTINE ISOLATE) CAPS (FOR INSULATED BUSBARS)

codice IW IW code	tipo type	per barre for busbars	sezione section	conf. pack.
2306062	TP1P30	1P	30 mm <sup>2</sup>	50
2306063	TP2P10	2P	10 mm <sup>2</sup>	50
2306060	TP3P16	3P	16 mm <sup>2</sup>	50
2306061	TP3P30	3P	30 mm <sup>2</sup>	10
2306064	TP4P16	4P	16 mm <sup>2</sup>	50



# FUSIBILI CILINDRICI INDUSTRIALI PORTAFUSIBILI SEZIONABILI SERIE "PCF" E PORTAFUSIBILI DA PANNELLO

## INDUSTRIAL CYLINDRICAL FUSES SERIES "PCF" MODULAR FUSEHOLDERS AND PANEL FUSEHOLDERS

Norme - Standards IEC EN 60269-1, IEC EN 60269-2, IEC EN 60947-3, VDE 0636

I portafusibili della serie PCF, per fissaggio su guida DIN, sono stati progettati in modo particolare per garantire la massima praticità del loro utilizzo in qualunque situazione. Essi possono anche contenere un fusibile di riserva, in modo da poter immediatamente sostituire quello intervenuto. Il corpo del portafusibile è realizzato in materiali termoplastici autoestinguenti e resistenti alle elevate temperature, mentre i relativi contatti sono in rame argentato. I portafusibili da pannello costituiscono invece una soluzione molto flessibile, perché sono facilmente montabili su pannello e garantiscono efficace protezione e facilità di accesso dal fronte quadro.

The fuseholders of the series PCF, for mounting on DIN rail, have been designed to ensure maximum flexibility of their use in every situation. In fact, they may also contain a spare fuse, so you can immediately replace the one that has operated. The body of the fuseholder is made by thermoplastic self-extinguishing and resistant to high temperatures material, while its contacts are made by silver-plated copper. The panel mounting fuseholders constitute a very practical solution, because they are easily mounted on panels and ensure effective protection and ease of access from the front side of the panel.



Portafusibile sez. PCF 1x31  
PCF 1x31 modular fuseholder

### PCF 31 - PORTAFUSIBILI SEZIONABILI (AC-22B) PER FUSIBILI CILINDRICI 8,5x31,5 PCF 31 - MODULAR FUSEHOLDERS (AC-22B) FOR 8,5x31,5 CYLINDRICAL FUSES

codice IW IW code	tipo type	n. poli poles	n. moduli 17,5 mm no. 17,5 mm modules	I <sub>n</sub> (A) I <sub>n</sub> (A)	V <sub>n</sub> (V) V <sub>n</sub> (V)	conf. pack.
2351031	PCF 1x31	1P	1	20A	400V	12
2354131	PCF 1x31 LED	1P	1	20A	400V	12
2351131	NPCF 1x31	1P+N	1	20A	400V	12
2352031	PCF 2x31	2P	2	20A	400V	6
2353031	PCF 3x31	3P	3	20A	400V	4
2354331	PCF 3x31 LED	3P	3	20A	400V	4
2353131	NPCF 3x31	3P+N	3	20A	400V	4



Portafusibile sez. PCF 1x38  
PCF 1x38 modular fuseholder





### PCF 38 - PORTAFUSIBILI SEZIONABILI (AC-22B) PER FUSIBILI CILINDRICI 10,3x38 PCF 38 - MODULAR FUSEHOLDERS (AC-22B) FOR 10,3x38 CYLINDRICAL FUSES

codice IW IW code	tipo type	n. poli poles	n. moduli 17,5 mm no. 17,5 mm modules	I <sub>n</sub> (A) I <sub>n</sub> (A)	V <sub>n</sub> (V) V <sub>n</sub> (V)	conf. pack.
2351038	PCF 1x38	1P	1	32A	690V	12
2351138	NPCF 1x38	1P+N	1	32A	690V	12
2352038	PCF 2x38	2P	2	32A	690V	6
2353038	PCF 3x38	3P	3	32A	690V	4
2353138	NPCF 3x38	3P+N	3	32A	690V	4



Portafusibile HK 10380  
HK 10380 fuseholder

### PORTAFUSIBILI DA PANNELLO PER FUSIBILI 10,3x38 PANEL MOUNTING FUSEHOLDERS FOR 10,3x38 FUSES

codice IW IW code	tipo type	V <sub>n</sub> (V) V <sub>n</sub> (V)	I <sub>n</sub> (A) I <sub>n</sub> (A)	descrizione description	conf. pack.	
0900500	HK 10380	600V	30A	Fissaggio con 2 viti laterali Corpo: resina fenolica UL 94-V1 Contatti: ottone nichelato Esec. tappo: a baionetta Esec. colleg.: attacchi faston 6,3 mm Omologazioni: 	Fixing with 2 screws on the sides Body: phenolic resin UL 94-V1 Contacts: tin plated brass Cap type: bayonet fixing Conn. type: faston connections 6,3 mm Approvals: 	50
0900501	HK 10381	600V	30A	Fissaggio con ghiera Corpo: resina fenolica UL 94-V1 Contatti: ottone nichelato Esec. tappo: a vite Esec. colleg.: attacchi faston 6,3 mm Grado di protezione: IP40 Omologazione: 	Fixing with lock-nut, Body: phenolic resin UL 94-V1 Contacts: tin plated brass Cap type: screw fixing Conn. type: faston connections 6,3 mm Protection class: IP40 Approval: 	50



Portafusibile HK 10381  
HK 10381 fuseholder

CILINDRICI  
CYLINDRICAL

# FUSIBILI CILINDRICI INDUSTRIALI PINZE PORTAFUSIBILI E ACCESSORI

## INDUSTRIAL CYLINDRICAL FUSES FUSE CLIPS AND ACCESSORIES

Le pinze portafusibili per fusibili cilindrici sono una soluzione pratica, economica ed affidabile per l'utilizzo dei fusibili su schede elettroniche e altre applicazioni speciali. Sono disponibili, differenziati per le tre classiche dimensioni dei fusibili cilindrici, in due versioni: per montaggio a vite o per montaggio mediante saldatura dei pin alla scheda. I tubetti di neutro, realizzati in materiale metallico, possono essere utilizzati all'interno dei relativi portafusibili per garantire la continuità ove non vi sia la necessità dell'uso di un fusibile. La pinza di estrazione per fusibili cilindrici costituisce un valido accessorio di sicurezza per l'inserimento e l'estrazione dei fusibili dai rispettivi portafusibili.

The fuse clips for cylindrical fuses are an economical and reliable solution for the use of fuses in electronic circuit boards and other special applications. They are available, differentiated by the three traditional dimensions of the cylindrical fuses, in two versions: for screw mounting or for mounting by soldering the pins to the board. The neutral tubes, made of metal, may be used within the related fuseholders to ensure continuity, where there is no need to use a normal fuse. The plier for the extraction of cylindrical fuses constitutes a safety accessory for the insertion and the extraction of the fuses from their respective fuseholders.



Pinza HK 10383  
HK 10383 plier

### PINZE PER FUSIBILI 10,3x38 FUSE CLIPS FOR 10,3x38 FUSES

codice IW IW code	tipo type	V <sub>n</sub> (V) V <sub>n</sub> (V)	I <sub>n</sub> (A) I <sub>n</sub> (A)	descrizione description	conf. pack.	
0900502	HK 10383	400V	30A	Fissaggio a saldare max potenza dissipabile: 4W	Connection: to be welded max power dissipation: 4W	250
0900504	HK 1038V	400V	30A	Fissaggio a vite max potenza dissipabile: 4W	Screw connection max power dissipation: 4W	250
1811940	HK 5538	–	–	Cappuccio trasparente per HK 10383	Transparent cover for HK 10383	500



Pinza HK 61001  
HK 61001 plier

### PINZE PER FUSIBILI 14x51 FUSE CLIPS FOR 14x51 FUSES

codice IW IW code	tipo type	V <sub>n</sub> (V) V <sub>n</sub> (V)	I <sub>n</sub> (A) I <sub>n</sub> (A)	descrizione description	conf. pack.	
0900506	HK 58058	690V	50A	Fissaggio a saldare max potenza dissipabile: 6W	Connection: to be welded max power dissipation: 6W	250
0900505	HK 61001	690V	50A	Fissaggio a vite max potenza dissipabile: 6W	Screw connection max power dissipation: 6W	250



Pinza HK 58061  
HK 58061 plier

### PINZE PER FUSIBILI 22x58 FUSE CLIPS FOR 22x58 FUSES

codice IW IW code	tipo type	V <sub>n</sub> (V) V <sub>n</sub> (V)	I <sub>n</sub> (A) I <sub>n</sub> (A)	descrizione description	conf. pack.	
0900507	HK 58060	690V	100A	Fissaggio a saldare max potenza dissipabile: 12W	Connection: to be welded max power dissipation: 12W	250
0900508	HK 58061	690V	100A	Fissaggio a vite max potenza dissipabile: 12W	Screw connection max power dissipation: 12W	250



Tubetto neutro  
Neutral tube

### TUBETTI NEUTRO NEUTRAL TUBES

codice IW IW code	tipo type	per portafusibili for fuseholders	conf. pack.
2498098	N08	BCH 31	10
2498099	N10	BCH 38	10
2498100	N14	BCH 51	10
2498101	N22	BCH 58	10



Pinza estrazione fusibili  
Plier for fuses extraction

### PINZA PER ESTRAZIONE FUSIBILI CILINDRICI PLIER FOR EXTRACTION OF CYLINDRICAL FUSES

codice IW IW code	tipo type	descrizione description	conf. pack.	
1812026	Q 9010	Per fusibili 10x38 - 14x51 - 22x58	For fuses 10x38 - 14x51 - 22x58	1

# FUSIBILI CILINDRICI CIVILI SERIE "C"

## CYLINDRICAL FUSES FOR BUILDING APPLICATIONS SERIES "C"

Norme - Standards CEI 32-1, CEI 32-5, IEC EN 60269-1, IEC EN 60269-3

I fusibili serie "C" vengono utilizzati in applicazioni di tipo civile come protezione contro i sovraccarichi ed i cortocircuiti. Essi presentano il corpo in steatite riempito con sabbia di quarzo. L'elemento fusibile interno ed i contatti sono realizzati in rame argentato. Sono impiegati per la protezione di circuiti classici. Un segnalatore di fusione indica visivamente l'avvenuto intervento. Potere di interruzione: 20 kA.

Series "C" fuses are used for building applications as protection against over current and short circuit. They have a steatite body filled with quartz sand. The internal fuse element is made by silver plated copper. These fuses are used to protect traditional circuits such as cables and circuits in buildings. A blown fuse indicator visually indicates that the fuse has blown. Breaking capacity: 20 kA.



Fusibile C0  
Fuse C0

### FUSIBILI SERIE C gG - DIMENSIONI 8,5x31,5 SERIES C gG FUSES - DIMENSIONS 8,5x31,5

codice IW IW code	tipo type	I <sub>n</sub> (A) I <sub>n</sub> (A)	V <sub>n</sub> (V) V <sub>n</sub> (V)	conf. pack.
1100002	C0	2A	400V	10-100
1100004	C0	4A	400V	10-100
1100006	C0	6A	400V	10-100
1100010	C0	10A	400V	10-100
1100016	C0	16A	400V	10-100
1100020	C0	20A	400V	10-100
1100025	C0	25A	400V	10-100



Fusibile C1  
Fuse C1

### FUSIBILI SERIE C gG - DIMENSIONI 9x36 SERIES C gG FUSES - DIMENSIONS 9x36

codice IW IW code	tipo type	I <sub>n</sub> (A) I <sub>n</sub> (A)	V <sub>n</sub> (V) V <sub>n</sub> (V)	conf. pack.
1110002	C1	2A	400V	10-100
1110004	C1	4A	400V	10-100
1110006	C1	6A	400V	10-100
1110010	C1	10A	400V	10-100
1110016	C1	16A	400V	10-100
1110020	C1	20A	400V	10-100
1110025	C1	25A	400V	10-100
1110030	C1	30A	400V	10-100
1110035	C1	35A	380V	10-100
1110040	C1	40A	380V	10-100



Fusibile C2  
Fuse C2

### FUSIBILI SERIE C gG - DIMENSIONI 13x50 SERIES C gG FUSES - DIMENSIONS 13x50

codice IW IW code	tipo type	I <sub>n</sub> (A) I <sub>n</sub> (A)	V <sub>n</sub> (V) V <sub>n</sub> (V)	conf. pack.
1120020	C2	20A	500V	10
1120025	C2	25A	500V	10

# DIMENSIONI E CARATTERISTICHE FUSIBILI CILINDRICI INDUSTRIALI

## DIMENSIONS AND SPECIFICATIONS INDUSTRIAL CYLINDRICAL FUSES

Caratteristiche tecniche e dimensioni in mm - Technical specifications and dimensions in mm

### FUSIBILI CILINDRICI INDUSTRIALI INDUSTRIAL CYLINDRICAL FUSES

I fusibili cilindrici per uso industriale hanno caratteristiche di impiego gG, aM e gR/aR. Il significato della prima lettera minuscola è il seguente:

“g”: cartuccia limitatrice di corrente, in grado di interrompere, in condizioni specificate, tutte le correnti che provocano la fusione dell'elemento fusibile fino al proprio potere d'interruzione nominale (protezione a pieno campo). Per protezioni da sovraccarichi e corto circuiti.

“a”: cartuccia limitatrice di corrente, in grado di interrompere, in condizioni specificate, tutte le correnti comprese tra la minima corrente d'interruzione ed il proprio potere d'interruzione nominale (protezione a campo ridotto). Per protezioni da corto circuiti e da sovraccarichi elevati.

La seconda lettera, indica la categoria di utilizzazione; questa lettera identifica con precisione le caratteristiche tempo/corrente, le correnti e i tempi convenzionali, e le porte.

Pertanto:

“gG” indica cartucce con potere di interruzione a pieno campo per uso generale

“aM” indica cartucce con potere di interruzione a campo ridotto per la protezione di motori (usate in genere in combinazione con un dispositivo di protezione contro i sovraccarichi).

“aR” indica cartucce con potere di interruzione a campo ridotto per la protezione di semiconduttori.

“gR” indica cartucce con potere di interruzione a pieno campo per la protezione di semiconduttori.

#### Caratteristiche costruttive

Il fusibile ha il corpo in steatite ed è adatto a sopportare le elevate sovratemperature che si innescano al momento della fusione. La sabbia di quarzo permette di estinguere l'arco in maniera efficace anche per elevate correnti di corto circuito. Al fine di garantire una migliore conducibilità elettrica, la capsula esterna e l'elemento di fusione sono in rame ricoperti d'argento.

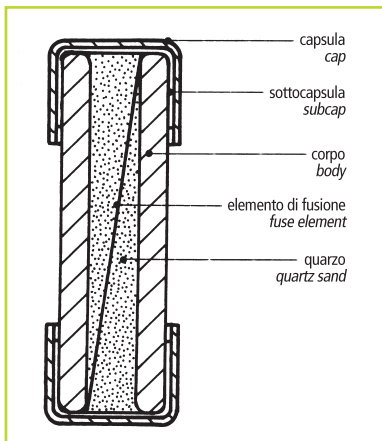

Industrial cylindrical fuses have gG, aM and gR/aR utilisation characteristics. The first small letter in the acronyms have the following meanings:

“g”: current limiting cartridge fuse which, in specific conditions, can break any current values causing the fuse element to melt up to its nominal breaking capacity (full range protection). Protection is guaranteed against overloads and short circuits;

“a”: current limiting cartridge fuse which, in specific conditions, can break current values between the minimum breaking current and the nominal breaking capacity (partial range protection). Protection is guaranteed against overloads and high overloads. The second letters in the acronyms indicate the utilisation category and precisely identifies the time-current characteristics, the currents, the conventional times and gates.

For example:

“gG” refers to cartridge fuses with full range breaking capacity for general purpose fuses;

“aM” refers to cartridge fuses with partial range breaking capacity and are used to protect motors (these fuses are usually installed in combination with a protective device against overloads);

“aR” refers to cartridge fuses with partial range breaking capacity and are used to protect semiconductors.

“gR” refers to cartridge fuses with full range breaking capacity and are used to protect semiconductors.

#### Construction specifications

The fuse body is made of steatite and can withstand the high overtemperatures which occur at the time of melting. Quartz sand efficiently extinguishes the arc even when high short circuit currents are present. For better electric conductivity the external cap and the fuse element are made of silver plated copper.

	8,5x31,5	10,3x38	14x51	22x58
A	8,5	10,3	14,3	22,2
B	31,5	38,0	51,0	58,0
C	6,3	8,5	11,5	15,5

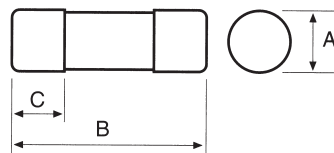

Esecuzione standard (CH) - Standard version (CH)

	8,5x31,5	10,3x38	14x51	22x58
A	—	—	14,3	22,2
B	—	—	51,0	58,0
C	—	—	11,5	15,5
D	—	—	8,0	8,0
E	—	—	4,0	4,0

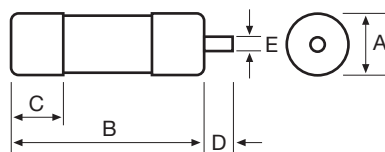

Esecuzione con percussore (CH/P) - Version with striker (CH/P)

# DIMENSIONI E CARATTERISTICHE FUSIBILI CILINDRICI INDUSTRIALI

## DIMENSIONS AND SPECIFICATIONS INDUSTRIAL CYLINDRICAL FUSES

Caratteristiche tecniche - *Technical characteristics*

### FUSIBILI SERIE "CH"- "SCH"- "CH/P" - TIPO gG SERIES "CH"- "SCH"- "CHIP" FUSES - gG TYPE

Caratteristiche d'intervento tempo-corrente - *Time-current characteristics*

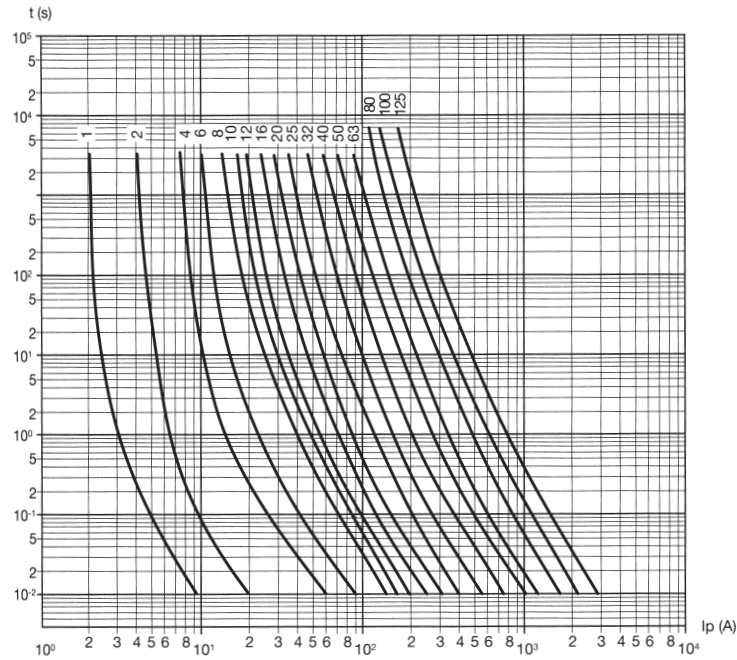

Caratteristiche di limitazione - *Cut-off characteristics*

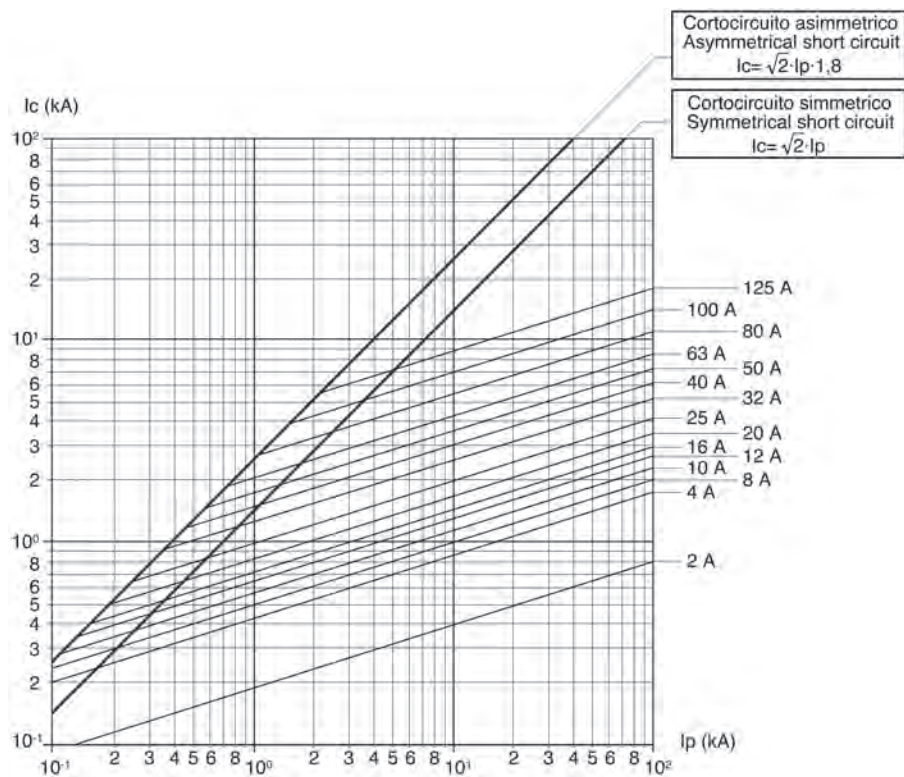

CILINDRICI  
CYLINDRICAL

# DIMENSIONI E CARATTERISTICHE FUSIBILI CILINDRICI INDUSTRIALI

## DIMENSIONS AND SPECIFICATIONS INDUSTRIAL CYLINDRICAL FUSES

### Caratteristiche tecniche - Technical characteristics

#### FUSIBILI SERIE "CH"- "SCH"- "CH/P" - TIPO gG SERIES "CH"- "SCH"- "CHIP" FUSES - gG TYPE

grandezza size	I <sub>n</sub> (A)	V <sub>n</sub> (V)	I <sub>k</sub> (kA)	P <sub>w</sub> (W)	I <sup>2</sup> t prearco (A <sup>2</sup> s) prearcing Ft (A <sup>2</sup> s)	I <sup>2</sup> t totale (A <sup>2</sup> s) - total Ft (A <sup>2</sup> s)		
						400V	500V	690V
CH8, SCH8 (8,5x31,5)	1	400	20	2,0	–	–	–	–
	2	400	20	0,5	6	12	–	–
	4	400	20	0,8	45	90	–	–
	6	400	20	1,1	70	140	–	–
	8	400	20	1,3	80	158	–	–
	10	400	20	1,4	120	248	–	–
	12	400	20	1,6	180	362	–	–
	16	400	20	1,7	270	536	–	–
	20	400	20	2,0	500	981	–	–
	25	400	20	2,4	800	1.688	–	–
CH10, SCH10 (10,3x38)	0,5	500	120	1,4	–	–	–	–
	1	500	120	2,7	–	–	–	–
	2	500	120	0,6	6	12	14	–
	4	500	120	0,7	45	90	108	–
	6	500	120	0,8	70	140	166	–
	8	500	120	0,9	80	158	188	–
	10	500	120	1,0	120	248	297	–
	12	500	120	1,3	180	362	431	–
	16	500	120	1,6	270	536	636	–
	20	500	120	2,0	500	981	1.162	–
	25	500	120	2,6	800	1.688	2.034	–
	32	400	120	2,9	1.200	2.412	–	–
	CH14, SCH14, CH/P14 (14x51)	1	690	80	3,9	–	–	–
2		690 <sup>(1)</sup>	80 <sup>(2)</sup>	0,9	6	12	14	19
4		690 <sup>(1)</sup>	80 <sup>(2)</sup>	1,0	45	90	108	150
6		690 <sup>(1)</sup>	80 <sup>(2)</sup>	1,15	70	140	166	230
8		690 <sup>(1)</sup>	80 <sup>(2)</sup>	1,0	80	158	188	260
10		690 <sup>(1)</sup>	80 <sup>(2)</sup>	1,3	120	248	297	420
12		690 <sup>(1)</sup>	80 <sup>(2)</sup>	1,7	180	362	431	600
16		690 <sup>(1)</sup>	80 <sup>(2)</sup>	2,0	270	536	636	880
20		690 <sup>(1)</sup>	80 <sup>(2)</sup>	2,5	500	981	1.162	1.600
25		690 <sup>(1)</sup>	80 <sup>(2)</sup>	3,3	800	1.688	2.034	2.900
32		500	120	3,5	1.200	2.412	2.871	–
40		500	120	4,75	2.500	4.907	5.808	–
50		400	120	4,8	5.100	11.262	–	–
CH22, SCH22, CH/P22 (22x58)	4	690	80	1,1	45	90	108	150
	6	690	80	1,3	70	140	166	230
	8	690	80	1,4	80	158	188	260
	10	690	80	1,5	120	248	297	420
	12	690	80	1,8	180	362	431	600
	16	690	80	2,1	270	536	636	880
	20	690	80	2,7	500	981	1.162	1.600
	25	690	80	3,3	800	1.688	2.034	2.900
	32	690	80	3,5	1.200	2.412	2.871	4.000
	40	690	80	4,0	2.500	4.907	5.808	8.000
	50	690	80	5,5	5.100	11.262	13.728	20.000
	63	690	80	6,9	7.900	16.451	19.762	28.000
	80	500	120	7,8	16.000	37.242	46.000	–
	100	500	120	9,0	28.000	68.072	85.000	–
125	400	120	11,4 <sup>(3)</sup>	40.000	120.000	–	–	

(1) Modello con percussore: 500V - Version with striker: 500V

(2) Modello con percussore: 120kA - Version with striker: 120kA

(3) Valore massimo previsto dalla IEC 60269-2-1: 9,5W - Maximum value described in IEC 60269-2-1: 9,5W

# DIMENSIONI E CARATTERISTICHE FUSIBILI CILINDRICI INDUSTRIALI

## DIMENSIONS AND SPECIFICATIONS INDUSTRIAL CYLINDRICAL FUSES

Caratteristiche tecniche - *Technical characteristics*

### FUSIBILI SERIE "CH"- "SCH"- "CH/P" - TIPO aM SERIES "CH"- "SCH"- "CH/P" FUSES - aM TYPE

Caratteristiche d'intervento tempo-corrente - *Time-current characteristics*

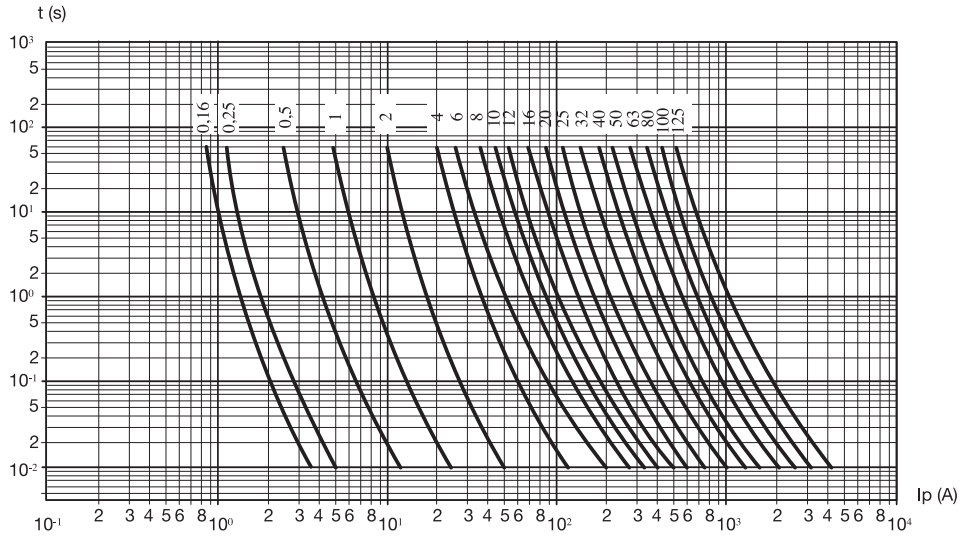

Caratteristiche di limitazione - *Cut-off characteristics*

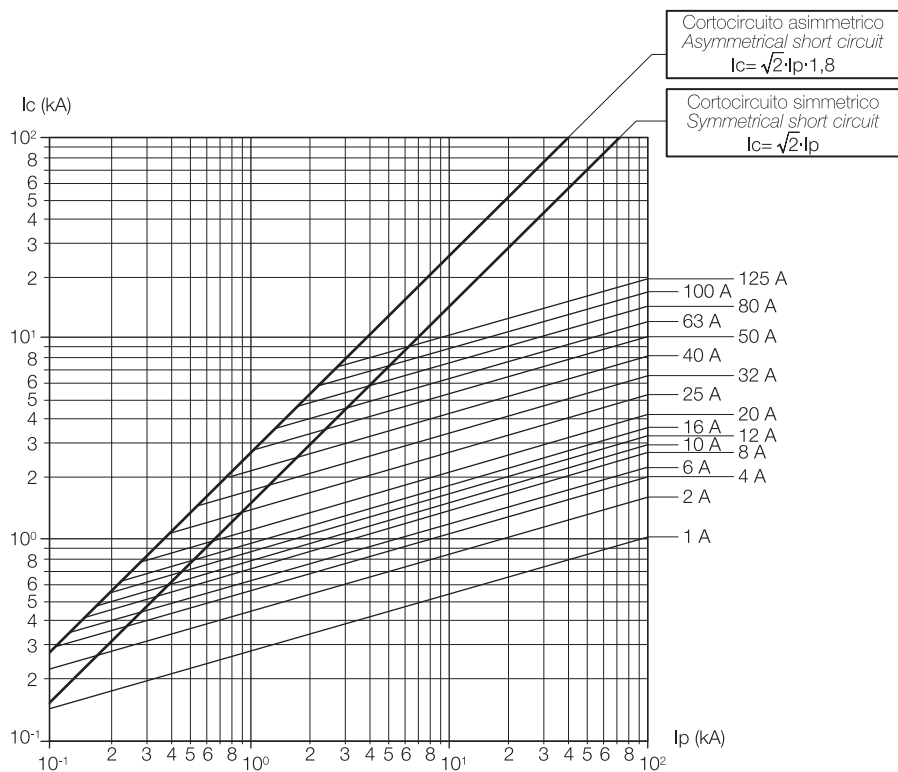

CILINDRICI  
CYLINDRICAL

# DIMENSIONI E CARATTERISTICHE FUSIBILI CILINDRICI INDUSTRIALI

## DIMENSIONS AND SPECIFICATIONS INDUSTRIAL CYLINDRICAL FUSES

### Caratteristiche tecniche - Technical characteristics

#### FUSIBILI SERIE "CH"- "SCH"- "CH/P" - TIPO aM

SERIES "CH"- "SCH"- "CH/P" FUSES - aM TYPE

grandezza size	I <sub>n</sub> (A)	V <sub>n</sub> (V)	I <sub>k</sub> (kA)	P <sub>w</sub> (W)	I <sup>2</sup> t prearco (A <sup>2</sup> s) prearcing Ft (A <sup>2</sup> s)	I <sup>2</sup> t totale (A <sup>2</sup> s) - total Ft (A <sup>2</sup> s)		
						400V	500V	690V
CH8, SCH8 (8,5x31,5)	1	400	20	0,10	10	19	–	–
	2	400	20	0,16	40	83	–	–
	4	400	20	0,25	90	181	–	–
	6	400	20	0,35	120	250	–	–
	8	400	20	0,40	220	448	–	–
	10	400	20	0,65	300	733	–	–
CH10, SCH10 (10,3x38)	0,16	500	120	0,24	–	–	–	–
	0,25	500	120	0,36	–	–	–	–
	0,5	500	120	0,49	–	–	–	–
	1	500	120	0,10	10	19	22	–
	2	500	120	0,18	40	83	99	–
	4	500	120	0,31	90	181	215	–
	6	500	120	0,32	120	250	300	–
	8	500	120	0,52	220	448	535	–
	10	500	120	0,55	300	733	916	–
	12	500	120	0,63	380	936	1.173	–
	16	500	120	0,92	550	1.608	2.103	–
	20	400	120	0,96	950	2.488	3.165	–
	25	400	120	1,40	1.300	3.728	–	–
	32	400	120	1,80	2.500	6.207	–	–
CH14, SCH14, CH/P14 (14x51)	1	690 <sup>(1)</sup>	80 <sup>(2)</sup>	0,14	10	19	22	30
	2	690 <sup>(1)</sup>	80 <sup>(2)</sup>	0,24	40	83	99	140
	4	690 <sup>(1)</sup>	80 <sup>(2)</sup>	0,45	90	181	215	300
	6	690 <sup>(1)</sup>	80 <sup>(2)</sup>	0,42	120	250	300	425
	8	690 <sup>(1)</sup>	80 <sup>(2)</sup>	0,70	220	448	535	750
	10	690 <sup>(1)</sup>	80 <sup>(2)</sup>	0,73	300	733	916	1.400
	12	690 <sup>(1)</sup>	80 <sup>(2)</sup>	0,88	380	936	1.173	1.800
	16	690 <sup>(1)</sup>	80 <sup>(2)</sup>	1,16	550	1.608	2.103	3.500
	20	690 <sup>(1)</sup>	80 <sup>(2)</sup>	1,23	950	2.488	3.165	5.000
	25	690 <sup>(1)</sup>	80 <sup>(2)</sup>	1,46	1.300	3.728	4.851	8.000
	32	500	120	2,04	2.500	6.207	7.791	–
	40	500	120	2,60	4.500	10.685	13.263	–
	50	400	120	2,90	10.000	19.626	–	–
	CH22, SCH22, CH/P22 (22x58)	4	690	80	0,48	90	181	215
6		690	80	0,47	120	250	300	425
8		690	80	0,73	220	448	535	750
10		690	80	0,74	300	733	916	1.400
12		690	80	0,83	380	936	1.173	1.800
16		690	80	1,21	550	1.608	2.103	3.500
20		690	80	1,29	950	2.488	3.165	5.000
25		690	80	1,53	1.300	3.728	4.851	8.000
32		690	80	2,13	2.500	6.207	7.791	12.000
40		690	80	3,40	4.500	10.685	13.263	20.000
50		690	80	3,48	10.000	19.626	23.230	32.000
63		690	80	4,46	15.000	31.520	37.950	54.000
80		500	120	5,86	30.000	59.088	70.000	–
100		500	120	6,61	50.000	113.945	140.000	–
125	400	120	8,42	80.000	200.000	–	–	

(1) Modello con percussore: 500V - Version with striker: 500V

(2) Modello con percussore: 120kA - Version with striker: 120kA



# DIMENSIONI E CARATTERISTICHE FUSIBILI CILINDRICI INDUSTRIALI

## DIMENSIONS AND SPECIFICATIONS INDUSTRIAL CYLINDRICAL FUSES

Caratteristiche tecniche - *Technical characteristics*

### FUSIBILI EXTRARAPIDI SERIE "CH"- "CH/P"- "FWC"- "FWP" - TIPO aR SERIES "CH"- "CHIP"- "FWC"- "FWP" HIGH SPEED FUSES - aR TYPE

Caratteristiche d'intervento tempo-corrente - *Time-current characteristics*  
Grandezza 10,3x38 - fuse size 10,3x38

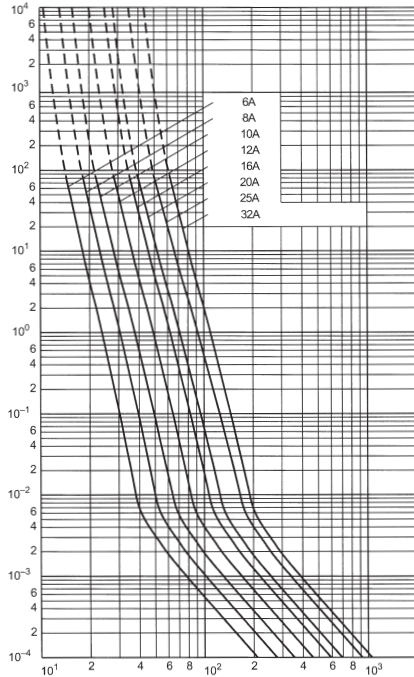

Caratteristiche di limitazione - *Cut-off characteristics*  
Grandezza 10,3x38 - fuse size 10,3x38

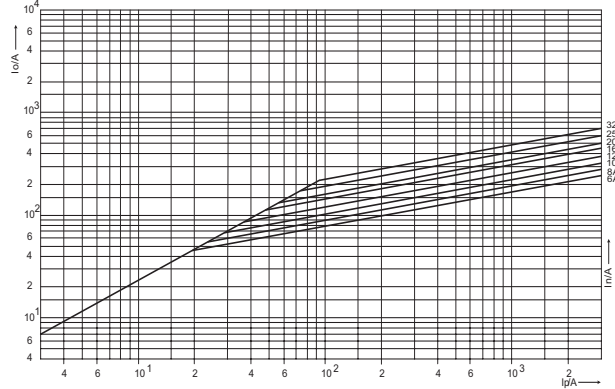

Caratteristiche d'intervento tempo-corrente - *Time-current characteristics*  
Grandezza 14x51 - fuse size 14x51

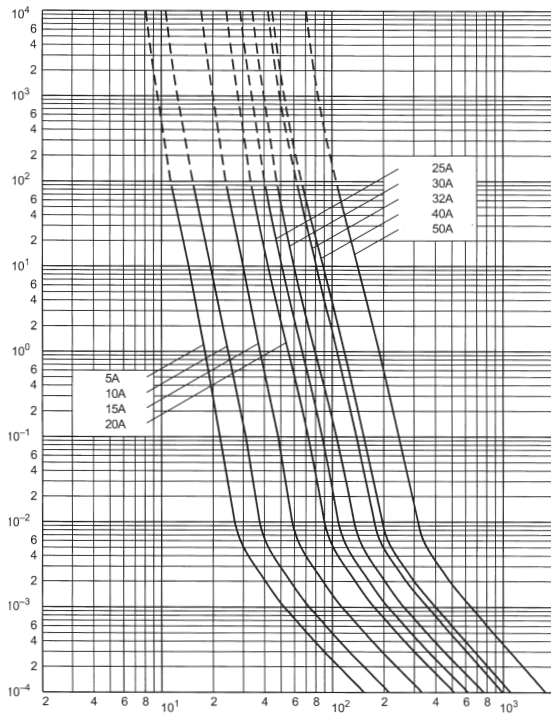

Caratteristiche di limitazione - *Cut-off characteristics*  
Grandezza 14x51 - fuse size 14x51

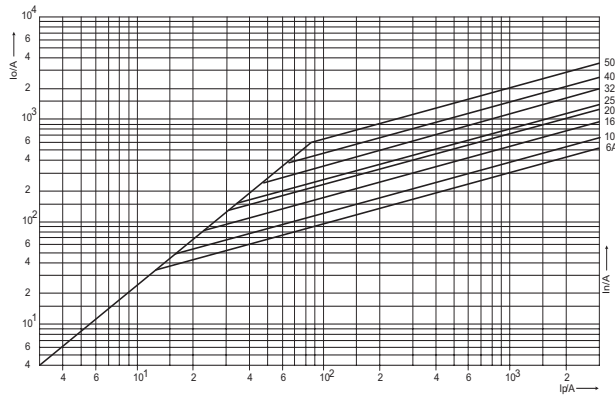

CILINDRICI  
CYLINDRICAL

# DIMENSIONI E CARATTERISTICHE FUSIBILI CILINDRICI INDUSTRIALI

## DIMENSIONS AND SPECIFICATIONS INDUSTRIAL CYLINDRICAL FUSES

### Caratteristiche tecniche - Technical characteristics

#### FUSIBILI EXTRARAPIDI SERIE "CH"- "CH/P"- "FWC"- "FWP" - TIPO aR SERIES "CH"- "CHIP"- "FWC"- "FWP" HIGH SPEED FUSES - aR TYPE

Caratteristiche d'intervento tempo-corrente - Time-current characteristics  
Grandezza 22x58 - fuse size 22x58

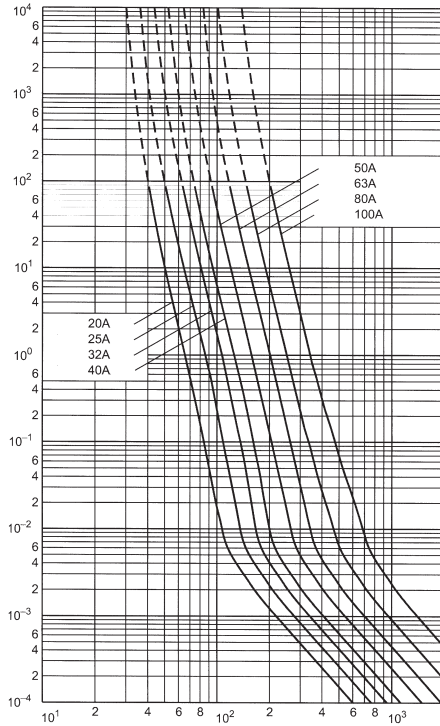

Caratteristiche di limitazione - Cut-off characteristics  
Grandezza 22x58 - fuse size 22x58

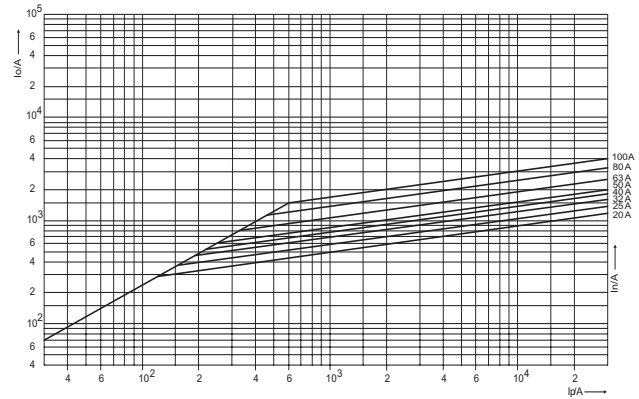

#### FUSIBILI EXTRARAPIDI SERIE "CH"- "CH/P" - TIPO aR SERIES "CH"- "CHIP" HIGH SPEED FUSES - aR TYPE

grandezza size	$I_n$ (A) $I_n$ (A)	$I_k$ (kA) $I_k$ (kA)	$P_w$ (W) $P_w$ (W)	$I^2t$ prearco (A <sup>2</sup> s) prearcing $I^2t$ (A <sup>2</sup> s)	$I^2t$ tot. (A <sup>2</sup> s) total $I^2t$ (A <sup>2</sup> s)
CH10 (10,3x38)	4	200	1,7	4,9	10
	6	200	2,0	5	35
	8	200	3,0	7	56
	10	200	3,5	10	77
	12	200	4,0	16	128
	16	200	4,5	27	159
	20	200	5,1	37	271
	25	200	6,3	69	401
CH14, CH/P14 (14x51)	32	200	8,0	115	613
	10	200	4,0	5	42
	12	200	4,5	8	69
	16	200	5,7	10	79
	20	200	6,3	26	185
	25	200	7,1	49	335
CH22, CH/P22 (22x58)	32	200	8,0	75	650
	40	200	9,5	94	800
	50	200	12,0	220	1.900
	20	200	5,0	25	270
	25	200	6,0	40	425
CH22, CH/P22 (22x58)	32	200	7,5	59	620
	40	200	9,2	74	770
	50	200	10,8	162	1.800
	63	200	13,6	288	3.300
	80	200	14,2	640	6.900
100	200	17,0	1.200	13.100	

#### FUSIBILI EXTRARAPIDI SERIE "FWC"- "FWP" - TIPO aR SERIES "FWC"- "FWP" HIGH SPEED FUSES - aR TYPE

grandezza size	$I_n$ (A) $I_n$ (A)	$I_k$ (kA) $I_k$ (kA)	$P_w$ (W) $P_w$ (W)	$I^2t$ prearco (A <sup>2</sup> s) prearcing $I^2t$ (A <sup>2</sup> s)	$I^2t$ tot. (A <sup>2</sup> s) total $I^2t$ (A <sup>2</sup> s)
10,3x38	—	—	—	—	—
	6	200	1,5	4	30
	8	200	2,0	6	50
	10	200	2,5	9	70
	12	200	3,0	15	120
	16	200	3,5	25	150
	20	200	4,8	34	260
	25	200	6,0	60	390
14x51	32	200	7,5	95	600
	5	200	3,5	3	31
	10	200	4	4	39
	15	200	5,5	8,6	70
	20	200	6	26	230
	25	200	7	47	375
22x58	32	200	7,6	68	600
	40	200	8	84	750
	50	200	9	200	1.800
	20	200	4,6	23	260
	25	200	5,6	37	410
22x58	32	200	7,0	55	605
	40	200	8,5	68	750
	50	200	10,0	155	1.600
	63	200	13,0	280	3.080
	80	200	13,5	600	6.600
100	200	16,0	1.100	12.500	

# DIMENSIONI E CARATTERISTICHE FUSIBILI CILINDRICI INDUSTRIALI

## DIMENSIONS AND SPECIFICATIONS INDUSTRIAL CYLINDRICAL FUSES

Caratteristiche tecniche - Technical characteristics

### FUSIBILI EXTRARAPIDI SERIE "AQS-F" - TIPO gR SERIES "AQS-F" HIGH SPEED FUSES - gR TYPE

Caratteristiche d'intervento tempo-corrente - Time-current characteristics  
Grandezza 10,3x38 - fuse size 10,3x38

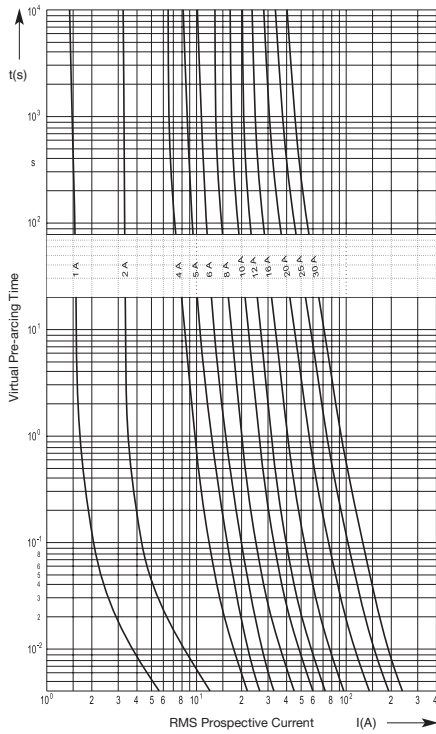

Caratteristiche di limitazione - Cut-off characteristics  
Grandezza 10,3x38 - fuse size 10,3x38

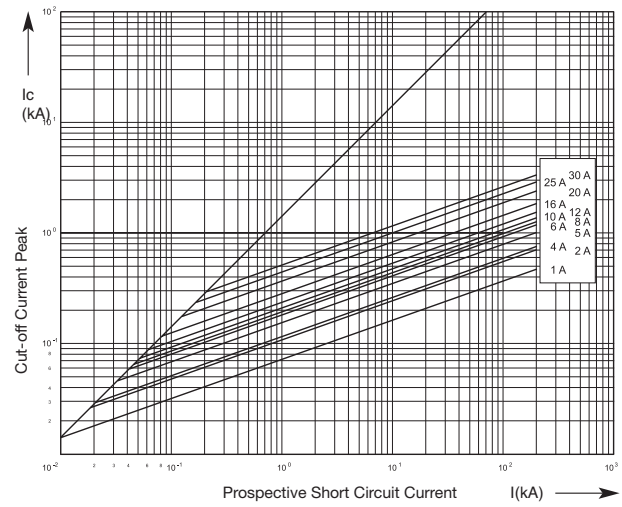

Caratteristiche d'intervento tempo-corrente - Time-current characteristics  
Grandezza 14x51 - fuse size 14x51

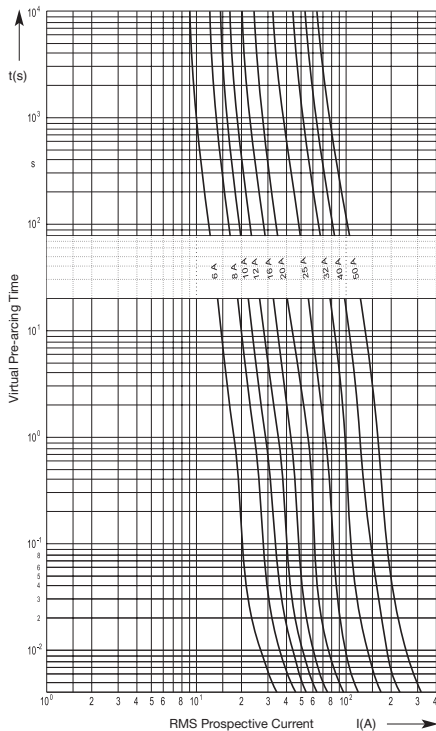

Caratteristiche di limitazione - Cut-off characteristics  
Grandezza 14x51 - fuse size 14x51

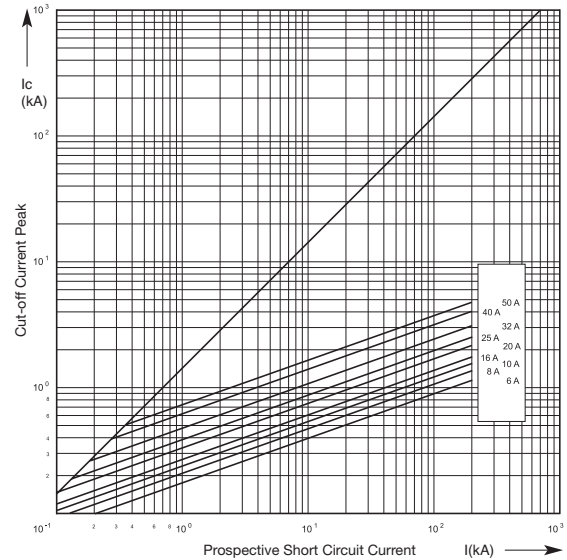

CILINDRICI  
CYLINDRICAL

# DIMENSIONI E CARATTERISTICHE FUSIBILI CILINDRICI INDUSTRIALI

## DIMENSIONS AND SPECIFICATIONS INDUSTRIAL CYLINDRICAL FUSES

### Caratteristiche tecniche - Technical characteristics

#### FUSIBILI EXTRARAPIDI SERIE "AQS-F" - TIPO gR SERIES "AQS-F" HIGH SPEED FUSES - gR TYPE

Caratteristiche d'intervento tempo-corrente - Time-current characteristics  
Grandezza 22x58 - fuse size 22x58

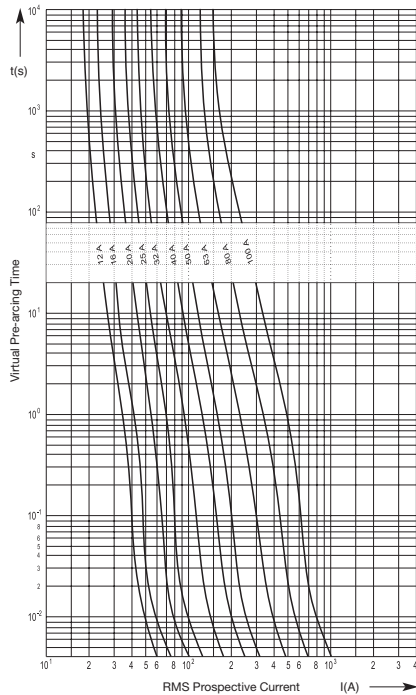

Caratteristiche di limitazione - Cut-off characteristics  
Grandezza 22x58 - fuse size 22x58

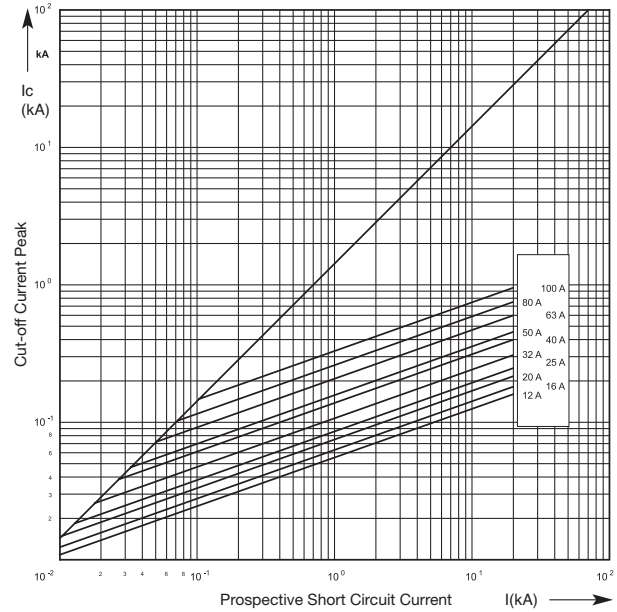

#### FUSIBILI EXTRARAPIDI SERIE "AQS-F" - TIPO gR SERIES "AQS-F" HIGH SPEED FUSES - gR TYPE

grandezza size	$I_n$ (A) $I_n$ (A)	$V_n$ (V) $V_n$ (V)	$I_k$ (kA) $I_k$ (kA)	$P_w$ (W) $P_w$ (W)	$I^2t$ prearco (A <sup>2</sup> s) prearcing $I^2t$ (A <sup>2</sup> s)	$I^2t$ totale (A <sup>2</sup> s) total $I^2t$ (A <sup>2</sup> s)
AQS-F 10,3x38	1	690	200	1,0	0,93	1,6
	2	690	200	1,8	0,64	8
	4	690	200	1,1	0,7	8
	6	690	200	1,6	2	25
	8	690	200	1,8	4,8	39
	10	690	200	2,1	5,3	66
	12	690	200	3,1	7,4	87
	16	690	200	4,4	10	166
	20	690	200	5,8	17	280
	25	690	200	6,8	40	580
AQS-F 14x51	30	690	200	8,2	60	1.010
	6	690	200	1,3	2,9	18
	8	690	200	1,7	5,1	28
	10	690	200	2,6	7,7	39
	12	690	200	3,1	8,1	75
	16	690	200	4,7	11	115
	20	690	200	6,0	21	190
	25	690	200	7,6	32	340
AQS-F 22x58	32	690	200	9,5	63	620
	40	690	200	10,0	140	1.050
	50	690	200	12,0	250	1.900
	20	690	200	6,0	21	91
	25	690	200	7,2	32	140
	32	690	200	9,6	63	315
AQS-F 22x58	40	690	200	12,0	140	610
	50	690	200	15,0	210	910
	63	690	200	16,0	510	2.260
	80	690	200	18,0	1.000	4.400
	100	690	200	19,0	2.050	8.900

# DIMENSIONI E CARATTERISTICHE PORTAFUSIBILI SEZIONABILI SERIE "BCH" E "DCH"

## DIMENSIONS AND SPECIFICATIONS SERIES "BCH" AND "DCH" MODULAR FUSEHOLDERS

### Caratteristiche tecniche - Technical characteristics

#### PORTAFUSIBILI SEZIONABILI BCH BCH MODULAR FUSEHOLDERS

##### Caratteristiche tecniche - Technical specifications

grandezza size	$I_n$ (A) $I_n$ (A)	$V_n$ (V) $V_n$ (V)	$U_{imp}$ (kV) $U_{imp}$ (kV)	$P_w$ max (W) $P_w$ max (W)	sez. cavo (mm <sup>2</sup> ) cable sect. (mm <sup>2</sup> )	categoria d'impiego utilization category	coppia serraggio cavi (Nm) cable tightening torque (Nm)
BCH 38	32	690	8	3	1,5 - 25	AC-22B	2 - 2,5
BCH 51	50	690	8	5	1,5 - 35	AC-22B	2,5 - 3
BCH 58	100	690	8	9,5	4 - 50	AC-20B	3,5 - 4

#### PORTAFUSIBILI SEZIONABILI DCH DCH MODULAR FUSEHOLDERS

##### Caratteristiche tecniche - Technical specifications

grandezza size	$I_n$ (A) $I_n$ (A)	$V_n$ (V) $V_n$ (V)	$U_{imp}$ (kV) $U_{imp}$ (kV)	$P_w$ max (W) $P_w$ max (W)	sez. cavo (mm <sup>2</sup> ) cable sect. (mm <sup>2</sup> )	categoria d'impiego utilization category	coppia serraggio cavi (Nm) cable tightening torque (Nm)
DCH 31	20	400	8	2,5	1 - 25	AC-22B	2
DCH 38	32	690	8	3	1 - 25	AC-22B	2
DCH 51	50	690	8	5	1,5 - 35	AC-22B	2,5 - 3
DCH 58	100	690	8	9,5	4 - 50	AC-21B	3

Limiti funzionamento LED: 50V / 690V AC

LED indicator operating range: 50V / 690V AC

##### Categoria d'impiego - Utilisation category

I suffissi A e B indicano rispettivamente applicazioni:

- con manovre frequenti (A);
- con manovre non frequenti (B).

Suffixes A and B indicate the following applications respectively:

- frequent use (A);
- infrequent use (B).

Sono previste le seguenti categorie (IEC EN 60947-3):

The following categories are included (IEC EN 60947-3):

Natura della corrente Type of current	Categoria d'impiego Utilisation category	Applicazione caratteristica Typical application
Corrente alternata Alternating current	AC-20A - AC-20B	Chiusura e apertura a vuoto (in questo caso gli apparecchi devono riportare l'indicazione "Non aprire sotto carico") Connecting and disconnecting under no-load (the devices must show a text "Do not open under load")
	AC-21A - AC-21B	Manovra di carichi resistivi, compresi sovraccarichi di modesta entità Switching of resistive loads, including moderate overloads
	AC-22A - AC-22B	Manovra di carichi misti resistivi e induttivi, compresi sovraccarichi di modesta entità Switching of mixed resistive / inductive loads, including moderate overloads
	AC-23A - AC-23B	Manovra di motori o altri carichi fortemente induttivi Switching of motors or other highly inductive loads
Corrente continua Direct current	DC-20A - DC-20B	Chiusura e apertura a vuoto (in questo caso gli apparecchi devono riportare l'indicazione "Non aprire sotto carico") Connecting and disconnecting under no-load (the devices must show a text "Do not open under load")
	DC-21A - DC-21B	Manovra di carichi resistivi, compresi sovraccarichi di modesta entità Switching of resistive loads, including moderate overloads
	DC-22A - DC-22B	Manovra di carichi misti resistivi e induttivi, compresi sovraccarichi di modesta entità Switching of mixed resistive / inductive loads, including moderate overloads
	DC-23A - DC-23B	Manovra di motori o altri carichi fortemente induttivi Switching of motors or other highly inductive loads

# DIMENSIONI E CARATTERISTICHE PORTAFUSIBILI SEZIONABILI SERIE "BCH"

## DIMENSIONS AND SPECIFICATIONS SERIES "BCH" MODULAR FUSEHOLDERS

Dimensioni in mm - Dimensions in mm

### PORTAFUSIBILI SEZIONABILI BCH BCH MODULAR FUSEHOLDERS

Portafusibili "BCH 38" per fusibili cilindrici 10,3x38 - "BCH 38" modular fuseholders for 10,3x38 cylindrical fuses

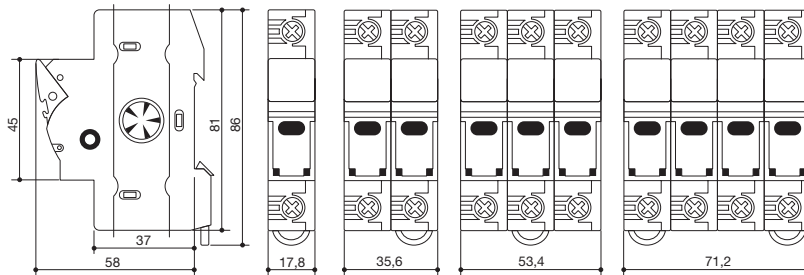

Portafusibili "BCH 51" per fusibili cilindrici 14x51 - "BCH 51" modular fuseholders for 14x51 cylindrical fuses

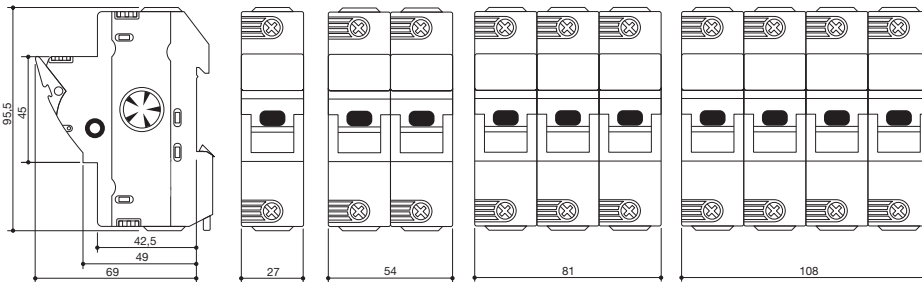

Portafusibili "BCH 58" per fusibili cilindrici 22x58 - "BCH 58" modular fuseholders for 22x58 cylindrical fuses

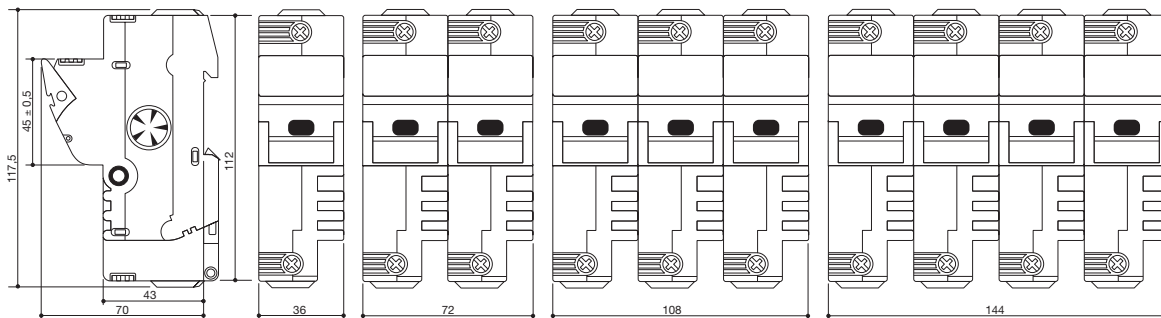

Portafusibili "BCH/P 51 e 58" per fusibili cilindrici con percussore - "BCH/P 51 and 58" modular fuseholders for cylindrical fuses with striker

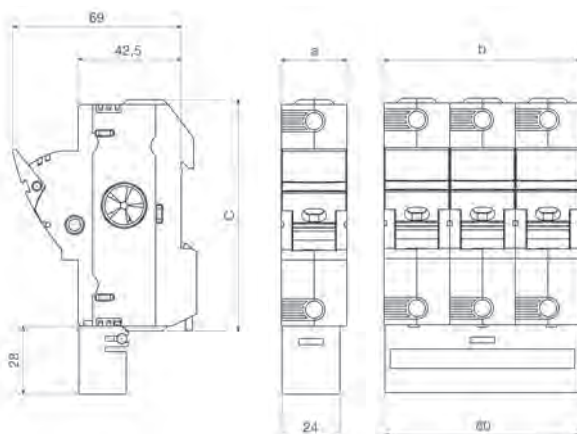

	1x51/P	3x51/P	1x58/P	3x58/P
A	27	—	36	—
B	—	81	—	108
C	96	96	118	118

# DIMENSIONI E CARATTERISTICHE PORTAFUSIBILI SEZIONABILI SERIE "DCH"

*DIMENSIONS AND SPECIFICATIONS  
SERIES "DCH" MODULAR FUSEHOLDERS*

Dimensioni in mm - Dimensions in mm

## PORTAFUSIBILI SEZIONABILI DCH DCH MODULAR FUSEHOLDERS

Portafusibili "DCH 31" e "DCH 38" per fusibili cilindrici 10,3x38 - "DCH 31" and "DCH 38" modular fuseholders for 10,3x38 cylindrical fuses

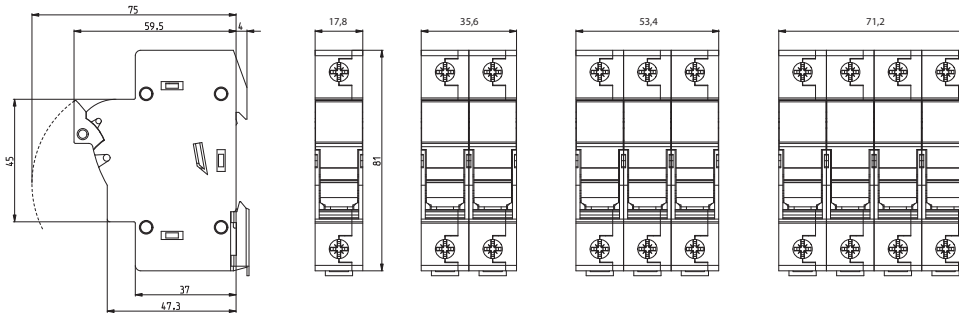

Portafusibili "DCH 51" per fusibili cilindrici 14x51 - "DCH 51" modular fuseholders for 14x51 cylindrical fuses

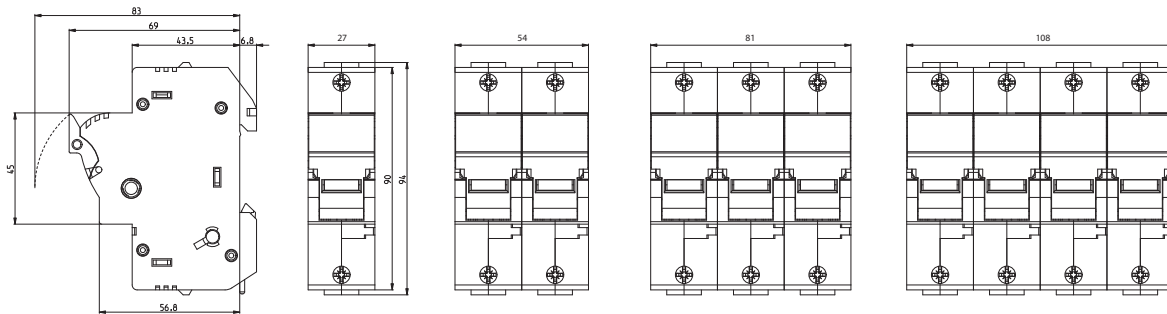

Portafusibili "DCH 58" per fusibili cilindrici 22x58 - "DCH 58" modular fuseholders for 22x58 cylindrical fuses

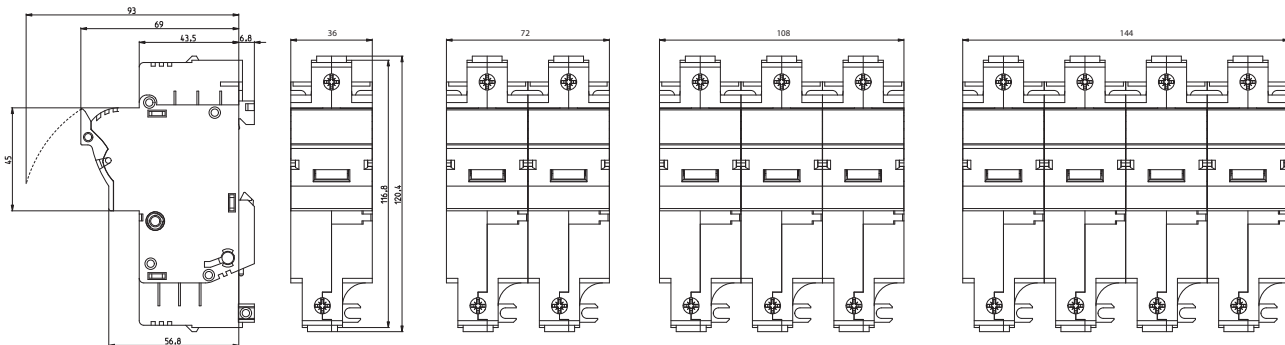

Microinterruttore per portafusibili "DCH 51" e "DCH 58" - Microswitch for "DCH 51" and "DCH 58" fuseholders

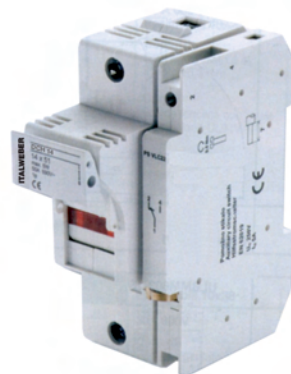
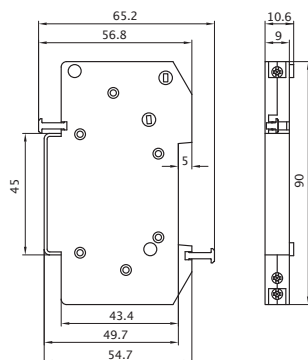

CILINDRICI  
CYLINDRICAL

# DIMENSIONI E CARATTERISTICHE PORTAFUSIBILI SERIE "PCF" E DA PANNELLO

## DIMENSIONS AND SPECIFICATIONS SERIES "PCF" FUSEHOLDERS AND PANEL FUSEHOLDERS

Dimensioni in mm - Dimensions in mm

### PORTAFUSIBILI SEZIONABILI PCF 31 MODULAR FUSEHOLDERS PCF 31

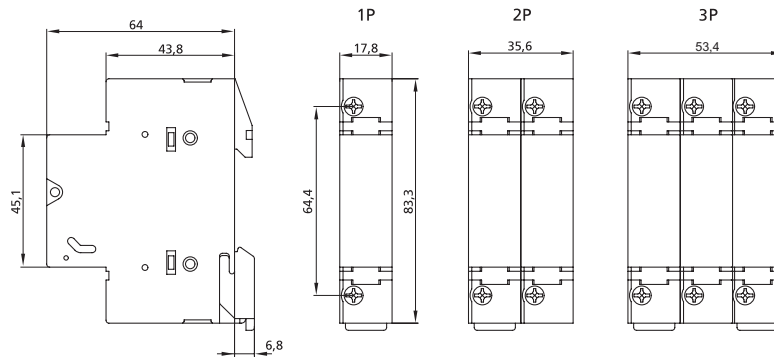

grandezza size	$I_n$ (A) $I_n$ (A)	$V_n$ (V) $V_n$ (V)	$U_{imp}$ (kV) $U_{imp}$ (kV)	$P_w$ max (W) $P_w$ max (W)	sez. cavo (mm <sup>2</sup> ) cable sect. (mm <sup>2</sup> )	categoria d'impiego utilization category	coppia serraggio cavi (Nm) cable tightening torque (Nm)
PCF 31	20	400	4	2,5	1,5 - 10	AC-22B	2 - 2,5

### PORTAFUSIBILI SEZIONABILI PCF 38 MODULAR FUSEHOLDERS PCF 38

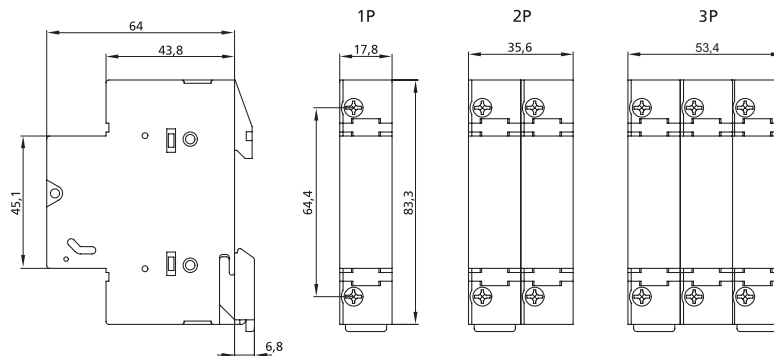

grandezza size	$I_n$ (A) $I_n$ (A)	$V_n$ (V) $V_n$ (V)	$U_{imp}$ (kV) $U_{imp}$ (kV)	$P_w$ max (W) $P_w$ max (W)	sez. cavo (mm <sup>2</sup> ) cable sect. (mm <sup>2</sup> )	categoria d'impiego utilization category	coppia serraggio cavi (Nm) cable tightening torque (Nm)
PCF 38	32	690	4	3	1,5 - 10	AC-22B	2 - 2,5

### PORTAFUSIBILI DA PANNELLO 0900500 PANEL MOUNTING FUSEHOLDERS 0900500

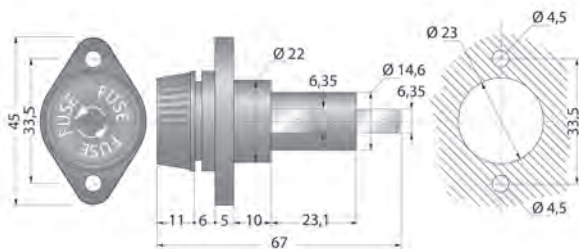

### PORTAFUSIBILI DA PANNELLO 0900501 PANEL MOUNTING FUSEHOLDERS 0900501

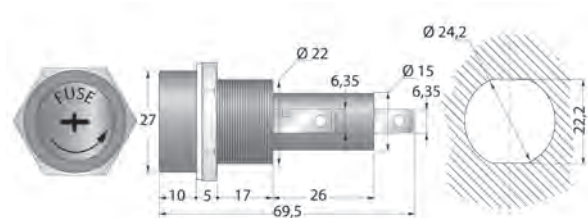



# DIMENSIONI E CARATTERISTICHE PINZE PER FUSIBILI CILINDRICI

*DIMENSIONS AND SPECIFICATIONS  
FUSE CLIPS FOR CYLINDRICAL FUSES*

Dimensioni in mm - Dimensions in mm

**PINZE PER FUSIBILI 10x38 0900502**  
FUSE CLIPS FOR FUSES 10x38 0900502

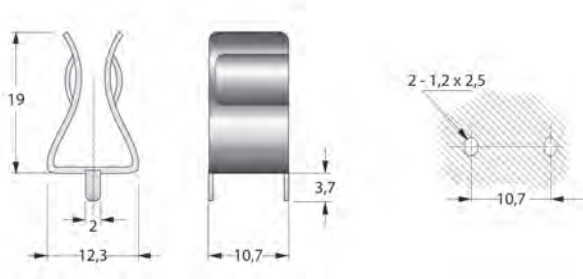

**PINZE PER FUSIBILI 10x38 0900504**  
FUSE CLIPS FOR FUSES 10x38 0900504

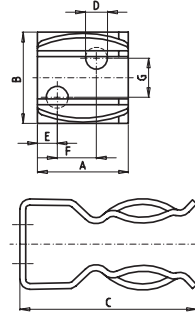

A	B	C	D	E	F	G
13	14	18	4,2	5	-	-

**PINZE PER FUSIBILI 14x51 0900506**  
FUSE CLIPS FOR FUSES 14x51 0900506

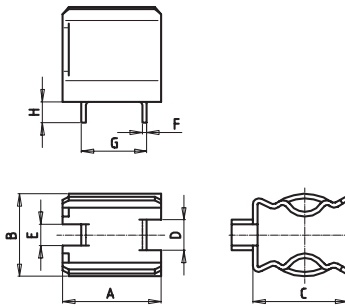

A	B	C	D	E	F	G	H
16	14	15,5	5	3,5	0,75	10,7	3,5

**PINZE PER FUSIBILI 14x51 0900505**  
FUSE CLIPS FOR FUSES 14x51 0900505

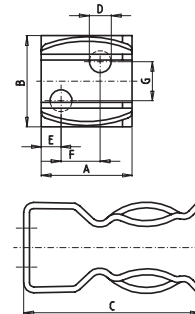

A	B	C	D	E	F	G
16	16	23	4,2	6,5	-	-

**PINZE PER FUSIBILI 22x58 0900507**  
FUSE CLIPS FOR FUSES 22x58 0900507

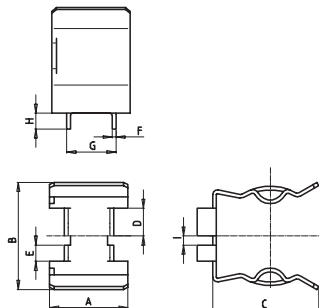

A	B	C	D	E	F	G	H
17	22	23	6	3,5	0,75	10,7	3,5

**PINZE PER FUSIBILI 22x58 0900508**  
FUSE CLIPS FOR FUSES 22x58 0900508

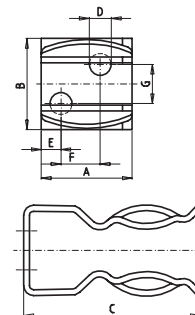

A	B	C	D	E	F	G
19	27	38	4,5	4	8	8

CILINDRICI  
CYLINDRICAL

# DIMENSIONI E CARATTERISTICHE FUSIBILI SERIE "C"

## DIMENSIONS AND SPECIFICATIONS SERIES "C" FUSES

Dimensioni in mm e caratteristiche tecniche - Dimensions in mm and technical characteristics

### FUSIBILI SERIE "C" SERIES "C" FUSES

Esecuzione C0 - C0 Version

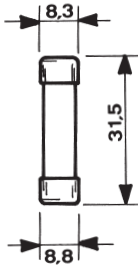

Esecuzione C1 - C1 Version

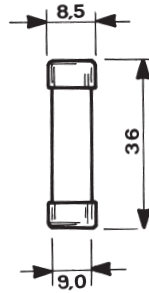

Esecuzione C2 - C2 Version



#### Fusibili serie C0 - Series C0 fuses

$I_n$ (A)	$I_k$ (kA)	$I^2t$ (400V~) (A <sup>2</sup> s)	$P_w$ (W)
2	20	8,5	0,90
4	20	60	1,35
6	20	130	1,40
10	20	332	1,45
16	20	850	2,10
20	20	1.600	2,30
25	20	2.850	3,20

#### Fusibili serie C1 - Series C1 fuses

$I_n$ (A)	$I_k$ (kA)	$I^2t$ (400V~) (A <sup>2</sup> s)	$P_w$ (W)
2	20	8,9	1,20
4	20	64	1,30
6	20	125	1,40
10	20	320	1,40
16	20	850	2,50
20	20	1.750	2,75
25	20	2.900	3,40
30	20	3.800	3,80
35	20	9.000	3,90
40	20	9.800	4,80

#### Caratteristiche d'intervento tempo-corrente - Time-current characteristics

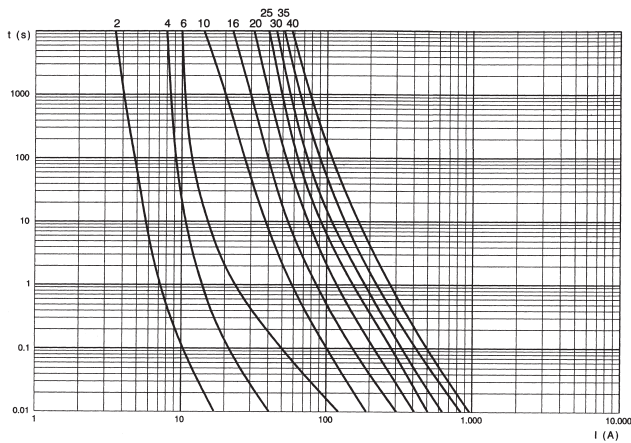

#### Caratteristiche di limitazione - Cut-off characteristics

