

Füllstandssensor Baureihe R

Level Controller Series R

Bezeichnung	R2T-3/5L20
Artikelnummer	130 61
Temperaturbereich Sonde	-10°C bis 250°C
Temperaturbereich Kabel	-10°C bis 200°C
Schutzart	IP 66
Material	PTFE / MS vernickelt
Kabel	1890mm PTFE-Kabel
Stecker	Rundsteckerverbinder 3-polig DIN 41524
Zubehör	---
Verwendung mit Schaltverstärker	CLS, CLC, CSV, SVK

Maximale Eintauchtiefe 20mm

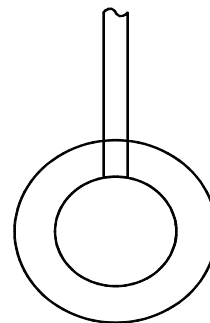
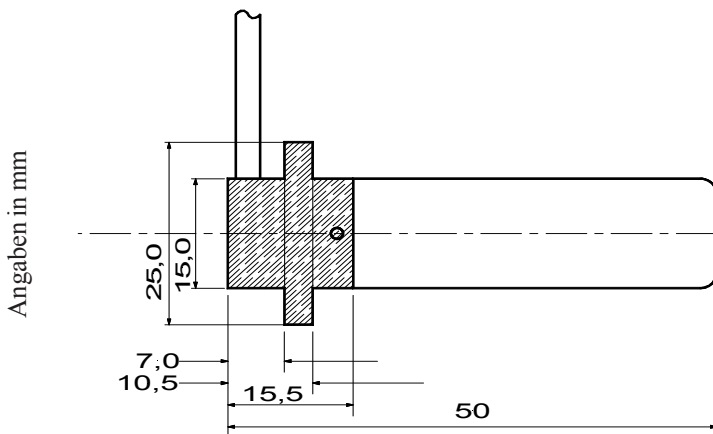

Maximal immersion depth 20mm

Type	R2T-3/5L20
Order No.	130 61
Ambient temperature Sensor	-10°C bis 250°C
Ambient temperature Cable	-10°C bis 200°C
Protection	IP 66
Material	PTFE / MS
Cable	1890mm PTFE-cable
Connector	3-phase DIN 41524
Accessories	---
Operational with switching amplifier	CLS, CLC, CSV, SVK