



**Swing Clamps with Overload Protection Device**  
block type, double acting,  
max. operating pressure 500 bar



**Application**

These swing clamps are used when it is required to keep the fixture workpiece area free of straps and clamping components for unrestricted workpiece loading and unloading.

**Function**

This hydraulic clamping element is a pull-type cylinder, where a part of the total stroke is used to swing the piston (swing stroke). The larger part of the stroke is available as clamping stroke.

**Versions**

The units are available in three standard sizes, optionally with clockwise or counterclockwise swing motion, and for each size three versions of standard clamping arms are available (see accessories, page 2).

Mounting of these clamping arms at any angle with 360°.

Standard swing angles of rotation are 45°, 60°, and 90° ±2°. Other variants, as e.g. versions with metallic wiper on request.

All units are equipped with piston rod wipers.

These double-acting swing clamps are also available in versions with minimum leakage rate. Please contact us!

**Danger of injury**

Hydraulic clamping elements can generate considerable forces.

Due to the 90° swing motion, the exact clamping and unclamping position cannot be determined in advance. Considerable injuries can be caused by squashing one's fingers in the effective area of the clamping arm.

Remedy: protection device with electrical locking.

**Materials**

By nitrating piston and housing, wear is reduced and protection against corrosion increased.  
Piston material and cylinder body: High alloy steel.

**Overload protection device**

An integrated mechanical overload protection device prevents damage to the swivel mechanism when striking an object within 90° rotation, clamping or unclamping alike.

**Importante notes!**

For manifold mounting without ports G 1/4 and the both cross holes Ø p.  
Operating conditions, tolerances and other data see data sheet A 0.100.

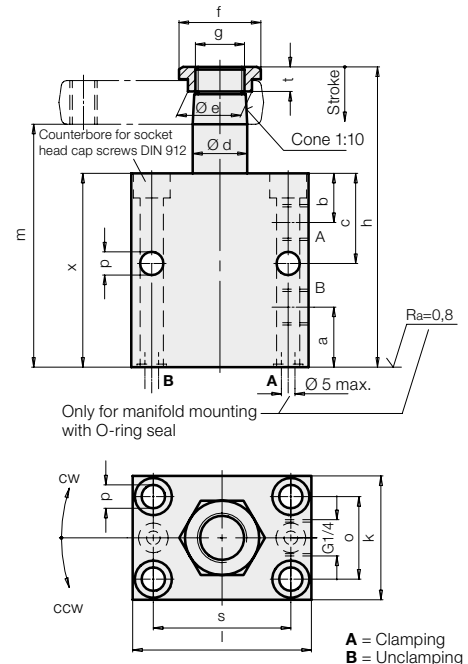

Total stroke	[mm]	14	16	20
Swing stroke	[mm]	7	8	9
Clamping stroke	[mm]	7	8	11
Operating pressure	[bar]	30	30	30
<b>Max. oil flow rate*</b>	[cm³/s]	3.2	10	27.7
Oil volume / stroke	[cm³]	2.5	7.3	23
Oil volume / return stroke	[cm³]	6.8	20	62
a	[mm]	22	25	26
b	[mm]	18	24	30
c	[mm]	33	40	50
Ø d	[mm]	20	32	50
Ø e	[mm]	23.5	33.5	55.5
f	[mm]	30	40	68
g	[mm]	M18x1.5	M28x1.5	M45x1.5
h	[mm]	110	139	174
k	[mm]	45	63	95
l	[mm]	65	85	125
m	[mm]	89	111	134
o	[mm]	30	40	65
p	[mm]	8.5	10.5	17
s	[mm]	50	63	95
t	[mm]	9	10	12
x	[mm]	71	91	110
Weight	[kg]	1.5	3.4	7.2
Swing direction cw	<b>Part no.</b>	<b>1893 106</b>	<b>1895 106</b>	<b>1897 106</b>
Swing direction ccw	<b>Part no.</b>	<b>1893 206</b>	<b>1895 206</b>	<b>1897 206</b>
0-degree	<b>Part no.</b>	<b>1893 246</b>	<b>1895 246</b>	<b>1897 246</b>
<b>Type for manifold mounting with O-ring seal</b>				
Swing direction cw	<b>Part no.</b>	<b>1893 506</b>	<b>1895 506</b>	<b>1897 506</b>
Swing direction ccw	<b>Part no.</b>	<b>1893 606</b>	<b>1895 606</b>	<b>1897 606</b>
0-degree	<b>Part no.</b>	<b>1893 646</b>	<b>1895 646</b>	<b>1897 646</b>
Spare O-ring 8x1.5	<b>Part no.</b>	<b>3000 343</b>		

FKM wiper standard

<b>Code numbers for available swing angles</b>	
Swing angle	Part no.
90°	189XX06
60°	189XX26
45°	189XX36

\* The max. oil flow rate is valid for vertical mounting position in connection with standard clamping arms. In the case that other mounting positions and/or other clamping arms are used, the oil flow rate has to be reduced as necessary. A possibly required flow control **has to be** made by flow control valves in the clamping line as well as in the unclamping line (stroke/return stroke).

**Effective clamping force  $F_{Sp}$  as a function of max. operating pressure  $p$**

**Double acting (1893X06)**  
Max. clamping arm length  $e$  [mm]

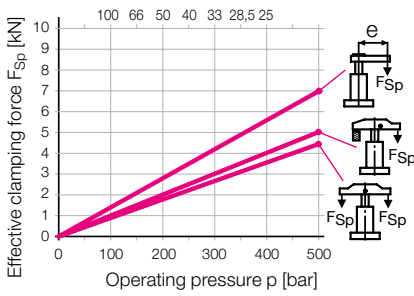

**Double acting (1895X06)**  
Max. clamping arm length  $e$  [mm]

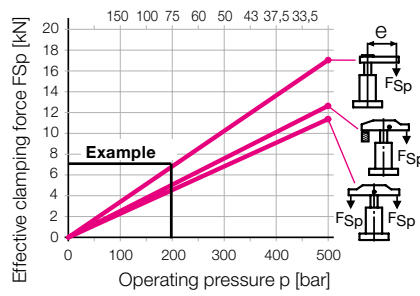

**Double acting (1897X06)**  
Max. clamping arm length  $e$  [mm]

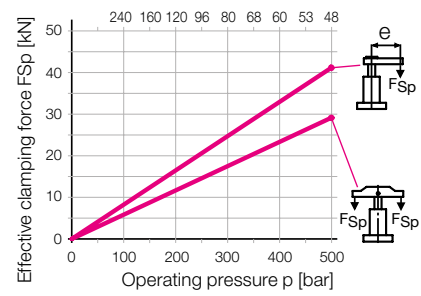

**Example:** 1895 106 An operating pressure  $p$  of 200 bar in connection with standard clamping arm 0354003 of arm length  $L = 75$  mm results in an effective clamping force  $F_{Sp}$  of 7 kN.

Dimensions for special clamping arms

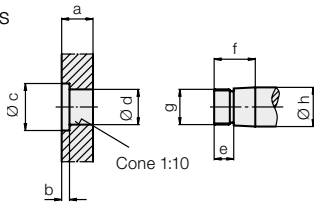

**Swing clamp**

	a	b	Ø c	Ø d <sup>+0.10</sup> <sub>+0.05</sub>	e	f	g	Ø h <sub>f7</sub>
1893XX6	16	4	24	19.8	10	21	M 18x1.5	20
1895XX6	23	5	34	31.8	12	28	M 28x1.5	32
1897XX6	34	6	56	49.8	13	40	M 45x1.5	50

Clamping arm assembly, complete max. 200 bar

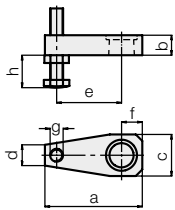

with thread  
without thread

**Swing clamp**

	a	b	c	d	e	f	g	h max.	h min.	Weight [kg]	Part no.
1893XX6	75	16	32	16	50	16	M10	64	6	0.2	<b>0354001</b>
1895XX6	115	23	48	22	75	25	M16	79	9	0.7	<b>0354003</b>
1897XX6	178	34	78	40	120	40	M20	98	12	2.55	<b>0354005</b>

**Schwenkspanner**

	a	b	c	d	f	Weight [kg]	Part no.
1893XX6	75	16	32	16	16	0.18	<b>3921016</b>
1895XX6	115	23	48	22	25	0.65	<b>3921017</b>
1897XX6	178	34	78	40	40	2.3	<b>3921018</b>

Clamping strap assembly, complete, with carrier, max. 500 bar

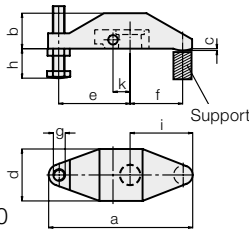

**Swing clamp**

	a	b	c	d	e	f	g	h max.	h min.	i	k	Weight [kg]	Part no.
1893XX6	122	30	1.5	44	60	45	M10	64	6	53	14.5	0.57	<b>0354000</b>
1895XX6	185	45	2	58.5	83	75	M16	79	9	87	21	1.58	<b>0354002</b>

Material: GGG-40

Carrier for special clamping strap

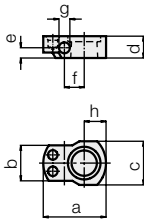

**Swing clamp**

	a	b	c	d	e	f	g <sup>H7</sup>	h	Weight [kg]	Part no.
1893XX6	46	26	32	16	7.5	14.5	8	16	0.08	<b>3542093</b>
1895XX6	59	32	40	23	13	21	10	22	0.16	<b>3542094</b>
1897XX6	90	56	68	34	21	33	14	36	0.65	<b>3542096</b>

Material: 42CrMo4

Doppelspanneisen, komplett, mit Träger, max. 500 bar

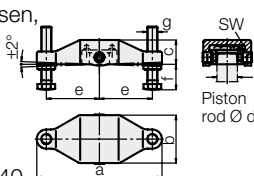

**Swing clamp**

	a	b	c	Ø d	e	f min.	f max.	g	SW	Weight [kg]	Part no.
18X3XXX	138	59	28.5	20	60	10	64	M 10	5	0.83	<b>0354131</b>
18X5XXX	196	75	38	32	83	15	79	M 16	8	2.11	<b>0354132</b>
18X7XXX	236	105	56	50	100	19	98	M 20	8	5.24	<b>0354134</b>

Material: GGG-40

Double clamping arm assembly, complete, with carrier, max. 500 bar

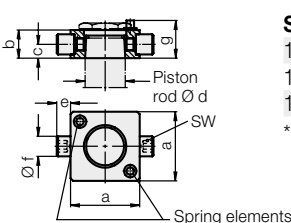

**Swing clamp**

	a±0.1	b	c	Ø d	e	Ø f <sup>g6</sup>	g*	SW	Part no.
18X3XXX	43	16	7.5	20	9	10	21.5	5	<b>0354141</b>
18X5XXX	55	23	11	32	11	16	29	8	<b>0354142</b>
18X7XXX	77	34	17	50	15	20	41	8	<b>0354144</b>

\* Stop surface for spring elements

Material: 42CrMo4