



# Grinnell



## G-FIRE Grooved Products Catalogue

**tyco**  
Fire Protection Products

## General Data

Why Grooved? . . . . .	6
Why GRINNELL? . . . . .	7
Agency Listings and Approvals. . . . .	8
ISO 9001:2008 Certified. . . . .	9
GRINNELL Website Overview. . . . .	10

## Grooved Couplings

Grooved Coupling Table of Contents. . . . .	12
Grooved Coupling Specifications . . . . .	13
Grooved Coupling Installation Information . . . . .	14
Figure 577 G-FIRE Rigid Couplings . . . . .	15
Figure 705 Flexible Couplings . . . . .	16
Figure 707 Heavy Duty Flexible Couplings . . . . .	17
Figure 716 Flexible Reducing Couplings . . . . .	18
Figure 770 High Pressure Rigid Couplings . . . . .	19
Figure 702 Outlet Couplings . . . . .	20 - 21
Figure 71 Flange Adaptors (PN10/PN16). . . . .	22 - 23
Figure 71 Flange Adaptors (ANSI Class 125/150). . . . .	24
Figure 71 Flange Adaptors (AS2129 Table E). . . . .	25
Flange Adaptor Washers. . . . .	26

## Grooved Fittings

Grooved Fittings Pictorial Table of Contents . . . . .	28
Grooved Fittings Specifications. . . . .	29
Figure 510S Short Pattern 90° Cast Elbows . . . . .	30
Figure 510 90° Cast Elbows . . . . .	30
Figure 501 45° Cast Elbows . . . . .	31
Figure 510DE 90° Drain Elbows with 25mm Outlet . . . . .	31
Figures 212 & 312, 22-1/2° Elbows. . . . .	32
Figures 211 & 311, 11-1/4° Elbows. . . . .	32
Figure 519S Short Pattern Tees. . . . .	33
Figures 519 Tees. . . . .	33
Figure 320 Groove x Groove x Male Thread Tees . . . . .	34
Figures 507/50L Bullhead Tees . . . . .	35
Figure 508 Standpipe Tees. . . . .	35
Figures 221 & 321 Reducing Tees . . . . .	36 - 38
Figure 323 Groove x Groove x Male Thread Reducing Tees. . . . .	39
Figures 391, 392 & 393 Adaptor Nipples. . . . .	40
Figure 372 Reducers, Small End Threaded (Male) . . . . .	41
Figures 250 & 350 Concentric Reducers . . . . .	42 - 43
Figures 227 & 327 Crosses . . . . .	44
Figure 750 ADACAP. . . . .	45
Figures 260 & 360 End Caps. . . . .	46
Figure 343 Flange Adaptors (PN16). . . . .	47
Figure 343 Flange Adaptors (PN10). . . . .	47
Figure 343 Flange Adaptors (JIS) . . . . .	47
Figure 341 Flange Adaptors (ANSI Class 150#) . . . . .	48
Figure 343 Flange Adaptors (Table E) . . . . .	48

## Mechanical Tees

Mechanical Tees & Crosses Pictorial Table of Contents . . . . .	50
Mechanical Tees & Crosses Material Specifications . . . . .	50
Figure 522 G-FIRE Sprinkler Outlet, Threaded . . . . .	51
Figure 730 Mechanical Tees & Crosses – Threaded . . . . .	52 - 54
Figure 730 Mechanical Tees & Crosses – Grooved. . . . .	55 - 57

## Valves

Valves Pictorial Table of Contents . . . . .	60
Model CV-1F G-FIRE Grooved Check Valves . . . . .	61
Model CV-1FR G-FIRE Grooved Shotgun Riser Check Valves. . . . .	62 - 63
Model BFV-N G-FIRE Butterfly Valves – Groove x Groove. . . . .	64
Model BFV-N G-FIRE Butterfly Valves – Wafer Style . . . . .	65
Model BFV-N G-FIRE Butterfly Valves – Lug Style . . . . .	66
Model TMR Resilient-Seated Gate Valves Outside Screw & Yoke (OS&Y) Overview. . . . .	67
Model TMRX Resilient-Seated Gate Valves Outside Screw & Yoke Flange x Flange . . . . .	68
Model TMRT Resilient-Seated Gate Valves Outside Screw & Yoke Flange x Groove. . . . .	69
Model TMRG Resilient-Seated Gate Valves Outside Screw & Yoke Groove x Groove . . . . .	69
Model TMCX-P Non Rising Stem Resilient-Seated Gate Valves Overview . . . . .	70
Model TMCX-P NRS Gate Valves Flange x Flange . . . . .	71
Model TMCT-P NRS Gate Valves Flange x Groove . . . . .	72
Model TMCG-P NRS Gate Valves Groove x Groove. . . . .	72
Model POST-IND Vertical Indicator Post . . . . .	73
Model WALL-IND Cross Wall Indicator Post. . . . .	74

## Gaskets

GRINNELL Gasket Types . . . . .	76
Gasket Styles . . . . .	77
GRINNELL Gasket Grade & Recommendations . . . . .	78
GRINNELL Gasket Lubricants . . . . .	78

## Preparation Equipment

Preparation Equipment Pictorial Table of Contents . . . . .	80
Roll Groove Standard Specification for Steel & Other IPS Pipe . . . . .	81
Cut Groove Standard Specification for Steel & Other IPS Pipe. . . . .	82
Automated Roll Groovers. . . . .	83
Portable Roll Groovers. . . . .	83
Field Portable Roll Groovers. . . . .	83
Portable Cut Groovers. . . . .	84
Pipe Support Stands . . . . .	84
Hole Cutting Tools . . . . .	84
Pipe Tape . . . . .	84
Model TWG-IV A Roll Grooving Machine . . . . .	85
Model TWG-IV Z Automatic Roll Grooving Machine . . . . .	86
Model TWG-VI A Portable Roll Grooving Machine . . . . .	87
Model TWK-III A Hole Cutting Tool . . . . .	88

## Pressure and Design Data

Design Data . . . . .	90
Misalignment & Deflection . . . . .	91
Pipe Support. . . . .	92 - 94
Flexible Joints . . . . .	92
Rigid Joints . . . . .	92
Rotational Movements . . . . .	93
Linear Movements . . . . .	93
Angular Movement . . . . .	94
Vertical Piping. . . . .	95
Flange Drilling Specifications . . . . .	96
Metric/Imperial Conversion Chart . . . . .	96
Pipe Conversion Table Wall Thickness . . . . .	97
Global Pipe Size Designations . . . . .	98
Listing and Approval Information . . . . .	99 - 106

## Indices





Keyword index . . . . .	108 - 109
Model number index . . . . .	110 - 111

## GRINNELL PRODUCTS

General Data

GRINNELL, a premium brand of Tyco International, delivers quality piping solutions for a full range of fire applications. Available products offer contractors, engineers, and distributors faster, more cost-effective tools for joining pipe over traditional welding methods. Innovative GRINNELL products include couplings, fittings, mechanical tees, valves, and accessories. Comprehensive, competitively priced engineering and planning support services provide labor and cost savings. All GRINNELL products are backed by an industry-leading, 10-year limited warranty. For more information, visit [www.grinnell.com](http://www.grinnell.com).



-  Regional Headquarters
-  Corporate Headquarters
-  Research and Development
-  APAC Sales and Distribution Centers

# MAKING CONNECTIONS...

### Global Headquarters

Lansdale, Pennsylvania, USA

### Research and Development

Cranston, Rhode Island, USA

### REGIONAL HEADQUARTERS

#### North Asia

Shanghai, China

#### South Asia

Singapore

#### Australia

Sunshine, Victoria

#### Middle East

Dubai, United Arab Emirates

#### South America, Central America, and Caribbean

Pompano, Florida, USA

#### Mexico

Tlalnepantla, Mexico

### Europe

Enschede, The Netherlands

Paris, France

Manchester, U.K.

Rodgau, Germany

Budapest, Hungary

Milan, Italy

Wien, Austria

Mechelen, Belgium

Madrid, Spain

Lørenskog, Norway

Lammhult, Sweden

### Asia-Pacific Sales and Distribution Centers

Hong Kong

Mumbai, India

Beijing, China

Chengdu, China

Guangzhou, China

Mount Waverley, Victoria, Australia

The products and specifications published herein are for general evaluation and reference purposes only and are subject to change by Tyco Fire Protection Products without notice. For the most up-to-date information, visit [www.grinnell.com](http://www.grinnell.com). The information provided in this catalog should not be relied on as a substitute for professional advice concerning specific applications. ALTHOUGH TYCO FIRE PROTECTION PRODUCTS ENDEAVORS TO ENSURE ACCURACY, ALL INFORMATION HEREIN IS PROVIDED ON AN "AS IS" BASIS, WITHOUT WARRANTY OF ANY KIND, EITHER EXPRESS OR IMPLIED. Without limiting the foregoing, Tyco Fire Protection Products does not warrant the accuracy, adequacy, or completeness of any such information. All users of the information provided herein assume the risk of use or reliance on such information and Tyco Fire Protection Products shall not be liable for any damages for such use including, but not limited to, indirect, special, incidental, or consequential damages.



General Data

# BUILDING SOLUTIONS



## Why Grooved?

### Reduced Installation Time and Cost

Methods such as threading and soldering are labor intensive and can be very expensive in high-cost regions. Pipe grooving reduces installation cost by up to 30%, allowing contractors to slash labor costs and remain within budget.



General  
Data

### Flexible Retrofits and Repairs

When an owner cannot afford to shut down a facility for important retrofits, GRINNELL Products solves the problem. GRINNELL Couplings and Fittings allow an installer to fabricate on-site and around complex problems and obstacles. Fire permits are not required and building residents do not have to evacuate due to welding fumes.



### Pipe Expansion Support

GRINNELL Flexible Couplings absorb linear and angular movements of pipe work due to temperature changes, eliminating or minimizing the use of expansion joints. Tyco Technical Services offers customers assistance with designing flexible couplings into thermal expansion projects.

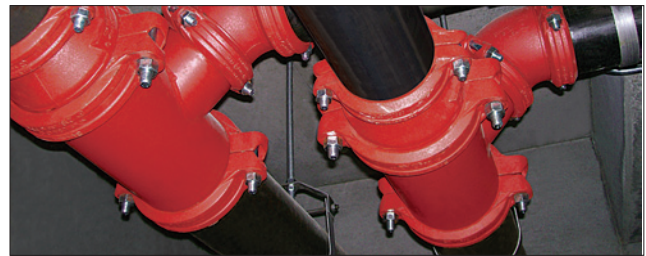

### No Special Tools

Grooved Products are assembled onto a standard groove. No special tools or additional training to complete the job are required.



### Compatibility With Hazardous Environments

Grooved Pipe does not require welding, threading, or cutting, eliminating cutting oils, fumes, and flames. It is the ideal method for joining pipe in enclosed, flammable, or hazardous sites like tunnels and mines. And it doesn't require burn or hot-works permits.



### Connection Consistency

When construction calls for tough piping applications, GRINNELL Grooved Products maintain high pressures at each connection without sacrificing quality and reliability. GRINNELL Grooved Systems allow for quick assembly that is simple and consistent from one worker to the next. Projects are completed on time, and crews can readily move on to their next installations.



## Why GRINNELL?



### The Best Warranty in the Industry

GRINNELL Products are backed by a 10-year limited warranty. Our customers are proud to work with products manufactured by a market leader with an established brand name and a consistent history.

General  
Data



### Industry Pioneer

GRINNELL Products has been in the pipe-joining business for over 160 years. We have strategic stocking locations throughout the world to serve our customers. We have the best channel partners who are focused, as we are, on innovation and growth.



### Green Solutions

All GRINNELL Products cast are manufactured with 90% recycled metal that would otherwise contribute to our nation's solid waste stream. All waste paper, used cardboard, scrap wood, and EPDM waste from our plants is recycled.



### Global Presence

You can find our products in buildings and installations all over the world. We provide global solutions that flexibly address the challenges our customers face, including design in one country for construction in another.



### Great Service

At Tyco Technical Services, the customer always comes first. We pride ourselves on providing knowledgeable sales support, timely technical service, and quality customer care to all global customers.

## Tyco Technical Services

2 Serangoon North Avenue,  
#07-01  
Singapore 554911  
Tel: +65 6577 4360  
Fax: +65 5648108791  
Email: sales-ap@tycofp.com

## Agency Listings and Approvals

Our products are associated with the following agencies, associations and laboratories. Contact GRINNELL for specific listings, approvals and certifications.

### General Code Groups, Associations, Laboratories, Government Agencies, and Approval Bodies

General Data

#### ACTIVFIRE

Active Fire Protection Product Certification 

#### AMERICAN BUREAU OF SHIPPING (ABS)



#### AMERICAN NATIONAL STANDARDS INSTITUTE (ANSI)

#### AMERICAN WATER WORKS ASSOCIATION (AWWA) AWWA C-606

#### AMERICAN PETROLEUM INSTITUTE (API) API Std. 5L

#### AMERICAN SOCIETY OF HEATING, REFRIGERATION AND AIR CONDITIONING ENGINEERS (ASHRAE)

#### AMERICAN SOCIETY OF MECHANICAL ENGINEERS (ASME)

- Power Piping, B-31.1
- Chemical Plant and Petroleum Refinery Piping, B-31.3
- Refrigeration Piping, B-31.5
- Building Services Piping, B31.9
- Elevator, Escalator, A17.1

#### ASTM

American Society of Testing Materials.  
F-1476 Couplings,  
F-1548 Fittings

#### BUILDING OFFICIALS AND CODE ADMINISTRATORS (BOCA)

#### BUREAU VERITAS (BV)



#### CERTIFICATION TO EUROPEAN PRESSURE EQUIPMENT DIRECTIVE



#### CNBOP

Centrum Naukowo-Badawcze Ochrony Przeciwpozarowej 

#### CNPP APSAD

National Centre for Prevention and Protection (FR) 

#### COAST GUARD

Approved each vessel individually

#### CORPS OF ENGINEERS (COE) GEGS 15000

#### CRN

Canadian Registration Number

#### DNV

Det Norske Veritas 

#### DVGW

Deutscher Verein des Gas-und Wasserfaches e.V. 

#### FACTORY MUTUAL ENGINEERING CORP. (FM)



Approved for Fire Protection Services

#### FEDERAL AVIATION ADMINISTRATION (FAA)

HVAC, Plumbing and Fire Protection

#### FEDERAL HOUSING ADMINISTRATION (FHA)

#### GENERAL SERVICES ADMINISTRATION (GSA) 15000 Series

#### GERMANISCHER LLOYD

 Germanischer Lloyd

#### INTERNATIONAL ASSOCIATION OF PLUMBING AND MECHANICAL OFFICIALS (IAPMO)



#### ICC-ES

National Evaluation Service, Inc.

#### LLOYD'S

Lloyd's Register of Shipping 

#### LOSS PREVENTION CERTIFICATION BOARD (LPCB)



Approved for Fire Protection Services  
Issue 03, 04, 07  
Cert No. 570, 669, 673

#### MATERIAL EQUIPMENT AND ACCEPTANCE (MEA)

#### MILITARY SPECIFICATIONS (MIL)

- MIL-P – 10388 Fittings
- MIL-C – 10387 Couplings
- MIL-P – 11087A (CE) Steel Pipe
- Grooved MIL-I – 45208 Inspection

#### NATIONAL AERONAUTICS AND SPACE ADMINISTRATION (NASA)

#### NATIONAL INSTITUTE OF HEALTH (NIH)

Department of Health – 5000 Series

#### NAVAL FACILITIES ENGINEERING COMMAND (NAVFAC)

NFGS 15000 Series

#### NATIONAL FIRE PROTECTION ASSOCIATION (NFPA)

#### NSF INTERNATIONAL

The Public Health and Safety Company 

#### PRESSURE EQUIPMENT DIRECTIVE (PED)

#### RINA

Registro Italiano Navale 

#### SOUTHERN BUILDING CODE CONGRESS INTERNATIONAL (SBCCI)

Standard Plumbing

#### UNDERWRITERS LABORATORIES, INC. (UL)

Listed for Fire Protection Services 

#### UNDERWRITERS LABORATORIES OF CANADA (ULC)

Listed for Fire Protection Services 

#### UNIFORM PLUMBING CODE (UPC)



#### VERBAND DER SACHVERSICHERE E.V. (VdS)

Approved for Fire Protective Service 

#### VETERANS AFFAIRS (VA)

15000 Series

#### WATERMARK

Standards Australia Limited 

#### WRAS

Water Regulations Advisory Scheme (UK) 

#### WSD

Pending Approved for Potable Water Service (HK)



## ISO 9001:2008 Certified

General Data

**LPCB®** www.redbooklive.com

---

**Certificate of Management System Registration**  
 Certificate Number: 673 Issue: 04

**Tyco Flow Control (M) Sdn. Bhd.**  
 (Tyco Fire Suppression & Building Products, Malaysia)

having complied with the requirements of:

**ISO 9001:2008**  
 Quality Management Systems – Requirements

are authorised to use the LPCB Certification Mark on stationary and publications related to the following products and/or services:

**Tyco Flow Control (M) Sdn. Bhd.**  
 (Tyco Fire Suppression & Building Products, Malaysia)  
 Lot 886, C1 & C2  
 Jalan Subang 9  
 Taman Perindustrian Subang  
 47500 Subang  
 Selangor  
 Malaysia

**Scope:**  
 Assembly of couplings and marketing of couplings and fittings.

This certificate is maintained and held in force through regular surveillance activities.

Signed for LPCB	Tracie Hunter Technical Manager	03 December 2013 Date of this Issue	02 December 2016 Expiry Date	10 January 2008 Date of First Issue
-----------------	------------------------------------	--	---------------------------------	--

This certificate and appendices remain the property of BRE Global Limited and is issued subject to terms and conditions (for details visit [www.redbooklive.com/terms](http://www.redbooklive.com/terms)). To check the validity of this certificate and appendices please scan the QR tag, visit [www.redbooklive.com/check](http://www.redbooklive.com/check) or contact us. LPCB is part of BRE Global Ltd., Garsington Road, Watlington, Oxford, OX4 9DQ, UK. T: +44 (0)1235 664100 F: +44 (0)1235 664033 E: [enquiries@brenglobal.com](mailto:enquiries@brenglobal.com)

BFD40 Rev 9.5 Page 1 of 1 © BRE Global Ltd, 2013



**Certificate of Quality System Registration**

**TYCO FIRE & BUILDING PRODUCTS**  
 Research & Development Centre, 1467 Elmwood Avenue,  
 Cranston, RI 02910, USA

has complied with the requirements of the following:

**ISO 9001:2008**

and is authorised to use the LPCB mark on stationary and publications related to the following products and/or services:

**Research, design, development and manufacturing support for the fire protection equipment, pipe couplings, fittings, related piping system components and CPVC pipe and fitting manufacturers of Tyco Fire and Building Products.**

*Tracie Hunter*  
**T A Hunter**  
 for and on behalf of LPCB

**Certificate No: 570**  
**Issue Number: 07**  
**Date of Issue: 16 August 2011**



**bre global**  
 DX: T: +44 (0)1235 664100 F: +44 (0)1235 664910 W: [www.redbooklive.com](http://www.redbooklive.com)  
 It and its issues are subject to terms and conditions. It is maintained and held in force.  
 © BRE Global Ltd, 2009

**LPCB®** www.redbooklive.com

---

**Certificate of Management System Registration**  
 Certificate Number: 669 Issue: 05

**Tyco Fire & Building Products**

having complied with the requirements of:

**ISO 9001:2008**  
 Quality Management Systems – Requirements

are authorised to use the LPCB Certification Mark on stationary and publications related to the following products and/or services:

**Tyco Fire & Building Products**  
 260 Central Castings Drive  
 Anneton  
 AL 36206  
 USA

**Scope:**  
 Manufacture of pipe couplings, fittings, related piping systems components and castings.

This certificate is maintained and held in force through regular surveillance activities.

Signed for LPCB	Tracie Hunter Technical Manager	01 March 2014 Date of this Issue	28 February 2017 Expiry Date	01 March 2005 Date of First Issue
-----------------	------------------------------------	-------------------------------------	---------------------------------	--------------------------------------

This certificate and appendices remain the property of BRE Global Limited and is issued subject to terms and conditions (for details visit [www.redbooklive.com/terms](http://www.redbooklive.com/terms)). To check the validity of this certificate and appendices please scan the QR tag, visit [www.redbooklive.com/check](http://www.redbooklive.com/check) or contact us. LPCB is part of BRE Global Ltd., Garsington Road, Watlington, Oxford, OX4 9DQ, UK. T: +44 (0)1235 664100 F: +44 (0)1235 664033 E: [enquiries@brenglobal.com](mailto:enquiries@brenglobal.com)

BFD40 Rev 9.5 Page 1 of 1 © BRE Global Ltd, 2013

## GRINNELL Website www.grinnell.com

General  
Data

To learn more about GRINNELL Products, visit [www.grinnell.com](http://www.grinnell.com). Our Website provides a wide variety of tools and information at your fingertips.

### Browse Features On Our grinnell.com Website

#### My Submittals Tab

This tool, useful in bidding, allows you sign up for a GRINNELL account. It's easy to use, and your product submittals download as one easy-to-read document. You can create, save, print, and manage project submittals.

#### Resources Tab

Useful for everyday operations, the Resources tab includes a conversion calculator to convert many units of measurement and a Product Cross Reference tool to search for GRINNELL product equivalents.

#### Literature Tab

The Literature tab showcases all marketing materials for viewing, downloading, or saving to your preferred location. Marketing literature includes catalogs, brochures, installation manuals, flyers, and price books.

#### Products Tab

The Products tab organizes all product information such as pricing, technical data, 3D CAD drawings, and part summary sheets. All product information is available for printing and saving to your preferred location. Searching for any product by name or figure number and downloading custom submittal sheets are also available through this tab.

#### Tech Data

The Tech Data tab provides direct access to technical information on all our products. It also provides access to online registration for automatic e-mail updates.

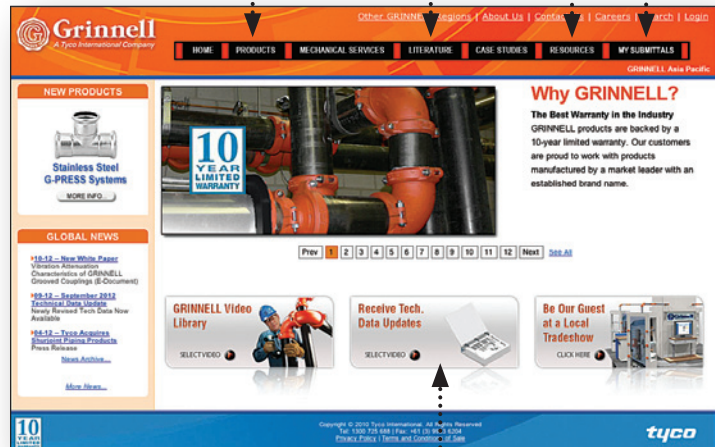

GRINNELL Homepage



G-FIRE GROOVED  
COUPLINGS

## Grooved Couplings

Grooved Couplings



**Figure 577**  
G-FIRE Rigid Couplings  
Page – 15



**Figure 705**  
Flexible Couplings  
Page – 16



**Figure 707**  
Heavy Duty Flexible Couplings  
Page – 17



**Figure 716**  
Flexible Reducing Couplings  
Page – 18



**Figure 770**  
High Pressure Rigid Couplings  
Page – 19



**Figure 702**  
Outlet Couplings  
Pages – 20-21



**Figure 71**  
Flange Adaptors & Washers  
Pages – 22-26

GRINNELL Couplings are designed for grooved end pipe and are available in nominal sizes of 25mm (1") to 300mm (12") including BS, ISO, and JIS outside diameters.

The GRINNELL Coupling Design provides economical advantages when compared to welded or flanged systems. GRINNELL Couplings provide a universal means for the connection of pipe, fittings, and pipe system components.

GRINNELL Couplings and Gaskets permit a wide selection of combinations for specific applications.

Field modifications are easily accommodated with GRINNELL Products as the couplings can be easily rotated, eliminated and/or added to facilitate necessary modifications.

## Grooved Coupling Specifications

### Rigid Connection

The Figure 577 Coupling has a patented design that grips the full 360° circumference of the pipe grooves. This design provides a more rigid and stronger connection through a range of pipe tolerances. The coupling design eliminates distortion of the gasket as the housing sections come together.

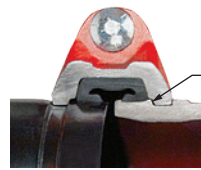

Full contact between Figure 577 Coupling key and groove diameter

### Trouble-Free Design

The patented universal tongue-and-groove design of the coupling housings assures trouble-free installation by avoiding the misalignment of the housings that could lead to a joint failure.



Grooved Couplings

### Quick Installation

GRINNELL Figures 577 and 705 Couplings, in sizes up to 300mm (12"), feature a clamshell design that allows for an easy one-bolt installation, thus saving time during field installations.



#### Additional Features:

- Two-piece, tongue-and-groove design allows for fast and easy installation
- Standard industry groove does not require special tools
- Backed by the industry's best 10-Year Limited Warranty



For Fire Protection Pressure Rating and Listing / Approval information contact Tyco Fire Protection Products.

## MATERIAL SPECIFICATIONS

### Ductile Iron Housing Specifications

- ASTM A 536 – Standard specification for ductile iron castings, Grade 65-45-12
- Tensile strength, minimum 448,159 kPa (65,000 psi)
- Yield strength, minimum 310,264 kPa (45,000psi)
- Elongation in 50mm (2"), minimum 12%
- ASTM A 153 – Standard specification for hot-dip galvanising

### Bolt/Nut Specifications

- Carbon steel oval neck bolts and nuts are heat-treated and conform to the physical properties of ASTM A 183 with a minimum tensile strength of 758,422 kPa (110,000 psi). Bolts and nuts are zinc electroplated to ASTM B 633.
- Gold colour coded metric bolts conforming to the physical properties of ASTM F 568M are available upon request. Contact GRINNELL Products.
- Stainless Steel nuts and bolts are UL Listed and comply with UL requirements. Bolts conform to ASTM A 193M, Class 2, Austenitic Stainless Steel. Nuts conform to ASTM A 194 Type 316, Grade 8M.

### Coatings

- Red – Non-lead paint (standard)
- Orange – Non-lead paint (standard)
- Hot-Dipped, Zinc Galvanised (Optional)

### Gasket Specifications

- **Grade "A" EPDMA** pre-lubricated gaskets have a violet colour code identification and conform to ASTM D 2000 for service temperatures from -34°C to 66°C (-30°F to 150°F). They are not recommended for hot water systems.
- **Grade "E" EPDM** gaskets have a green colour code identification and conform to ASTM D 2000 for service temperatures from -34°C to 110°C (-30°F to 230°F). They are recommended for hot water not to exceed 110°C (230°F). They are not recommended for petroleum services.
- **Grade "E" EPDM Tri-Seal** gaskets have a green colour code identification and conform to ASTM D 2000 for service temperatures from -34°C to 110°C (-30°F to 230°F). They are recommended for dry pipe freezer systems.

## Coupling Installation Information

Installation Handbook: IH-1000FP

Grooved  
Couplings

### • WARNING

*Failure to follow these instructions may result in improper product installation, joint failure or leakage, serious personal injury, and/or property damage.*

The following instructions should be used as a guideline for the proper installation of GRINNELL Grooved Products.

1. Always read and understand the instructions.
2. To avoid serious personal injury always wear appropriate personal protective equipment (ppe), such as safety glasses, hard hat and foot protection.
3. Never remove any piping component without verifying that the system is de-pressurized and drained. Failure to do so may result in serious personal injury.
4. Ensure that the supplied gasket is suitable for the intended application. To prevent deterioration of the gasket material, a petroleum lubricant should never be used. Use a recommended lubricant to install the gasket.
5. The pipe groove dimensions must be in accordance with Standard Roll Groove or Cut Groove Specifications. Refer to Pages 89 to 90 or Tech Data Sheet TFP1898 for additional information.
6. Ensure that the coupling keys are engaged in the grooves.
7. Always tighten nuts evenly by alternating sides. Uneven tightening can cause the gasket to pinch or bind. If a gasket becomes pinched, replace it immediately.
8. Torque values are supplied as a guideline and may be used when setting the torque on power impact wrenches. Always refer to the power impact wrench manufacturer's instructions for settings.
9. Exceeding the suggested torque values may cause damage to the coupling and/or result in pipe-joint failure. Minimum bolt torque is required for coupling to meet the published performance parameters.
10. Always inspect each joint to ensure that the coupling is properly installed.

EPDM, Tri-Seal gaskets are recommended for freezer applications. Reducing Couplings are not recommended for freezer applications. For dry pipe and freezer applications, use the Tri-Seal freezer gasket with a petroleum-free silicone lubricant. Standard lube is not recommended for this application as it freezes and can cause leakage.

These installation instructions do not take the place of nor do they eliminate the need for the installer to fully read and understand the complete GRINNELL Products Installation Handbook (refer to IH-1000FP). Always review the GRINNELL Products Installation Handbook and individual product tech data sheets for the latest instructions, techniques, and care and maintenance information. This document does not supersede or replace the GRINNELL Products Installation Handbook or individual product tech data sheets. Current documentation can be obtained by contacting Tyco Technical Services or visiting [www.grinnell.com](http://www.grinnell.com).

### ASME Standard Note

\*Note: The samples that were tested contained the GRINNELL Figure 707 high pressure flexible couplings, and the GRINNELL Figure 260 end caps of the appropriate size. These were used on the assembly to test system components as related in a field environment. The rated or working pressure of these items is 68.9 bar (1,000 psi)

\*Note: The material of both the fittings and couplings used in this testing is found on page nine of the GRINNELL Handbook. This material is Ductile Iron Casting Grade 65-45-12, which has an elongation in 51mm (2") of 12%.

The **Component Proof Test** in ASME A17.1 – 2004, section 3.19.1.3 requires testing to section 8.2.8.5, or five times the rated pressure.

The calculation of the factor of safety located in section 8.2.8.5 would then be calculated as  $F = (5.04 / 12 - 2.8) + 2.7$ . This then, according to section 8.2.8.5, would be a requirement safety factor of 3.25. The minimum pressure requirement of these components then would be 224.1 bar (3,250 psig)

## Figure 577 G-FIRE Rigid Couplings

Tech Data Sheet: TFP1854

**10**  
YEAR  
LIMITED  
WARRANTY

The GRINNELL Figure 577 Grooved Rigid Coupling provides a rigid joint by firmly gripping along the full circumference of the pipe grooves. Figure 577 Grooved Rigid Couplings are a proven dependable method of joining pipe and are an economical alternative to welding, threading, or using flanges. It is capable of pressures up to 350 psi (24,1 bar) depending on pipe size and wall thickness when used in fire protection services.



Grooved  
Couplings

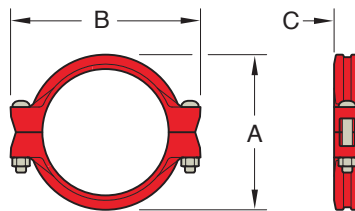

Pipe Size		Max.† Pressures kPa psi	Max.† End Load kN Lbs.	Max.*‡ End Gap mm Inches	Dimensions - mm Inches			Coupling Bolts Size ** (Qty 2) mm Inches	Approx. Weight kg Lbs.
Nominal mm Inches	O.D. mm Inches				A	B	C		
25	33,4	2413	2,11	1,5	41	100	42	M10 x 57	0,55
1	1.315	350	475	0.06	1.63	3.92	1.65	3/8 x 2 1/4	1.2
32	42,4	2413	3,37	1,5	68	112	42	M10 x 57	0,59
1 1/4	1.660	350	757	0.06	2.66	4.40	1.64	3/8 x 2 1/4	1.3
40	48,3	2413	4,41	1,5	74	118	42	M10 x 57	0,68
1 1/2	1.900	350	992	0.06	2.90	4.66	1.66	3/8 x 2 1/4	1.5
50	60,3	2413	6,90	1,5	86	132	43	M10 x 57	0,82
2	2.375	350	1,551	0.06	3.38	5.20	1.70	3/8 x 2 1/4	1.8
65	73,0	2413	10,11	1,5	99	143	44	M10 x 57	0,91
2 1/2	2.875	350	2,272	0.06	3.88	5.64	1.75	3/8 x 2 1/4	2.0
65	76,1	2413	11,01	1,5	102	147	44	M10 x 57	0,91
76.1mm	3.000	350	2,474	0.06	4.00	5.78	1.75	-	2.0
80	88,9	2413	14,98	1,5	114	161	44	M10 x 57	1,50
3	3.500	350	3,367	0.06	4.50	6.33	1.75	3/8 x 2 1/4	3.3
100	114,3	2068	21,22	1,5	145	191	46	M10 x 57	1,50
4	4.500	300	4,771	0.06	5.70	7.50	1.83	3/8 x 2 1/4	3.3
125	139,7	2068	31,71	3,2	173	222	49	M12 x 76	2,41
139.7mm	5.500	300	7,127	0.125	6.80	8.75	1.91	-	5.3
125	141,3	2068	32,43	3,2	174	224	49	M12 x 76	2,41
5	5.563	300	7,290	0.125	6.86	8.82	1.91	1/2 x 3	5.3
150	165,1	2068	44,28	3,2	198	248	49	M12 x 76	2,59
165.1mm	6.500	300	9,955	0.125	7.80	9.75	1.91	-	5.7
150	168,3	2068	46,00	3,2	215	251	49	M12 x 76	2,68
6	6.625	300	10,341	0.125	8.47	9.88	1.91	1/2 x 3	5.9
200	219,1	2068	77,97	3,2	260	325	61	M16 x 83	5,32
8	8.625	300	17,528	0.125	10.25	12.78	2.40	5/8 x 3 1/4	11.7
250 □	273,0	1206	70,7	6,4	318	419	65	M20 x 121	8,86
10	10.750	175	15,883	0.25	12.50	16.50	2.56	3/4 x 4 3/4	19.5
300 □	323,9	1206	99,4	6,4	368	470	65	M20 x 121	10,00
12	12.750	175	22,343	0.25	14.50	18.50	2.56	3/4 x 4 3/4	22.0

\* Maximum available gap between pipe ends. Minimum gap = 0.

† Maximum Pressure and End Load are total from all loads based on on standard weight steel pipe. Pressure ratings and end loads may differ for other pipe materials and/or wall thicknesses. Contact GRINNELL Products for details.

‡ Max End Gap is for cut grooved standard weight pipe. Values for roll grooved pipe will be half that of cut grooved.

\*\* Gold color coded metric bolt sizes for 25 - 300mm couplings are available upon request.

□ For 250 and 300mm sizes where VdS Approval is required, refer to Figure 772, Technical Data Sheet G140.

For information on larger sizes, Chinese sizes or other alternative sizes, contact GRINNELL Products.

See page 13 for general notes, and see pages 76 - 78 for gasket information.

## Figure 705 Flexible Couplings

Tech Data Sheet: TFP1820

**10**  
YEAR  
LIMITED  
WARRANTY



The GRINNELL Figure 705 Flexible Coupling allows for angular and linear deflection, thermal expansion and contraction, and misalignments of pipe. It is capable of pressures up to 2,068 kPa (300 psi), depending on pipe size and wall thickness. Suitable for use in a variety of applications, the Figure 705 Coupling provides a dependable method of joining pipe.

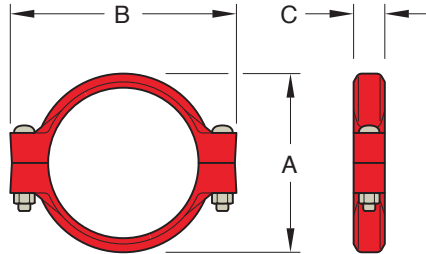

For Fire Protection Pressure Rating and Listing / Approval information contact Tyco Fire Protection Products.

Grooved Couplings

Pipe Size		Max. † Pressures kPa psi	Max. † End Load N Lbs.	Max. ‡ End Gap mm Inches	Deflection ‡		Dimensions - mm Inches			Coupling Bolts Size (Qty 2) mm Inches	Approx. Weight kg Lbs.
Nominal mm Inches	O.D. mm Inches				Degrees Per Coupling	mm/m Inches/Ft	A	B	C		
25	33.7	2068	1,810	3.3	5° 30'	96.7	56.9	100.1	46.0	M10 x 57	0.6
1	1.315	300	407	0.13		1.16	2.24	3.94	1.81	3/8 x 2-1/4	1.3
32	42.4	2068	2,887	3.3	4° 19'	75.0	65.0	106.4	46.0	M10 x 57	0.7
1-1/4	1.660	300	649	0.13		0.90	2.56	4.19	1.81	3/8 x 2-1/4	1.5
40	48.3	2068	3,781	3.3	3° 46'	65.8	69.9	112.8	46.0	M10 x 57	0.7
1-1/2	1.900	300	850	0.13		0.79	2.75	4.44	1.81	3/8 x 2-1/4	1.6
50	60.3	2068	5,907	3.3	3° 1'	52.5	82.6	124.0	47.8	M10 x 57	0.8
2	2.375	300	1,328	0.13		0.63	3.25	4.88	1.88	3/8 x 2-1/4	1.7
65	73.0	2068	8,660	3.3	2° 29'	43.3	93.7	139.7	47.8	M10 x 57	0.9
2-1/2	2.875	300	1,947	0.13		0.52	3.69	5.50	1.88	3/8 x 2-1/4	2.0
65	76.1	2068	9,430	3.3	2° 23'	41.7	101.6	146.1	47.8	M12 x 76	1.4
76.1mm	3.000	300	2,120	0.13		0.50	4.00	5.75	1.88	-	3.1
80	88.9	2068	12,832	3.3	2° 3'	35.8	111.3	165.1	47.8	M12 x 76	1.4
3	3.500	300	2,885	0.13		0.43	4.38	6.50	1.88	1/2 x 3	3.1
100	108.0	2068	18,931	6.4	3° 22'	58.3	139.7	190.5	52.3	M12 x 76	1.9
108.0mm	4.250	300	4,256	0.25		0.70	5.50	7.50	2.06	-	4.2
100	114.3	2068	21,213	6.4	3° 11'	55.8	144.5	196.9	52.3	M12 x 76	1.8
4	4.500	300	4,769	0.25		0.67	5.69	7.75	2.06	1/2 x 3	4.0
125	133.0	2068	28,885	6.4	2° 44'	46.7	166.6	241.3	52.3	M16 x 83	3.3
133.0mm	5.250	300	6,494	0.25		0.56	6.56	9.50	2.06	-	7.2
125	139.7	2068	31,701	6.4	2° 36'	45.5	173.0	247.7	52.3	M16 x 83	3.3
139.7mm	5.500	300	7,127	0.25		0.55	6.81	9.75	2.06	-	7.2
125	141.3	2068	32,417	6.4	2° 35'	45.0	174.8	247.7	52.3	M16 x 83	3.2
5	5.563	300	7,288	0.25		0.54	6.88	9.75	2.06	5/8 x 3-1/4	7.1
150	159.0	2068	40,939	6.4	2° 17'	40.0	192.0	261.9	52.3	M16 x 83	3.4
159.0mm	6.250	300	9,204	0.25		0.48	7.56	10.31	2.06	-	7.4
150	165.1	2068	44,258	6.4	2° 12'	38.3	196.9	271.5	52.3	M16 x 83	3.2
165.1mm	6.500	300	9,950	0.25		0.46	7.75	10.69	2.06	-	7.1
150	168.3	2068	45,975	6.4	2° 10'	37.8	201.7	271.5	52.3	M16 x 83	3.2
6	6.625	300	10,336	0.25		0.45	7.94	10.69	2.06	5/8 x 3-1/4	7.1
200 JIS	216.3	2068	75,723	6.4	1° 40'	29.2	255.8	342.9	58.7	M20 x 121	5.6
216.3mm	8.500	300	17,024	0.25		0.35	10.07	13.50	2.31	-	12.4
200	219.1	2068	77,925	6.4	1° 40'	29.2	258.8	344.4	63.5	M20 x 121	6.6
8	8.625	300	17,519	0.25		0.35	10.19	13.56	2.50	3/4 x 4-3/4	14.5
250 ▶	273.0	1723	100,876	6.4	1° 20'	23.3	322.3	416.1	66.8	M24 x 165	12.7
10	10.750	250	22,679	0.25		0.28	12.69	16.38	2.63	1 x 6-1/2	28.0
300 ▶	323.9	1723	141,905	6.4	1° 7'	19.5	379.5	479.6	66.8	M24 x 165	14.6
12	12.750	250	31,903	0.25		0.23	14.94	18.88	2.63	1 x 6-1/2	32.2

\* Maximum available gap between pipe ends. Minimum gap = 0.

† Maximum pressure and end load are total from all loads based on standard weight steel pipe. Pressure ratings and end loads may differ for other pipe materials and/or wall thickness. Contact GRINNELL Products for details.

‡ Max end gap and deflection is for cut grooved standard weight pipe. Values for roll grooved pipe will be half that of cut grooved.

▶ Sizes are available to JIS standards. Contact GRINNELL Products for details.

For information on larger sizes, Chinese sizes or other alternative sizes, contact GRINNELL Products.

See page 13 for general notes, and see pages 76 - 78 for gasket information.



## Figure 707 Heavy Duty Flexible Couplings

Tech Data Sheet: TFP1840



The GRINNELL Figure 707 Heavy Duty Flexible Coupling allows for angular and linear deflection, thermal expansion and contraction, and misalignments of the pipe. Flexible couplings can act as an "expansion joint", allowing linear and angular movement of the pipes when properly installed. This coupling is capable of pressures up to 3,447 kPa (500 psi), depending on pipe size and wall thickness. Suitable for use in a variety of applications, the Figure 707 Coupling provides a dependable method of joining pipe.

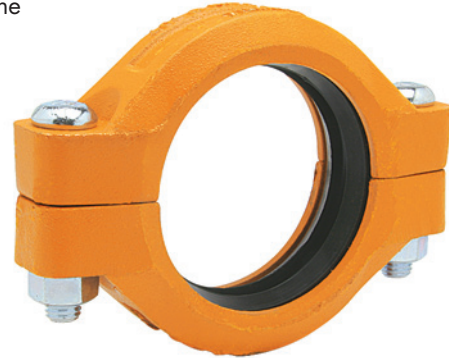
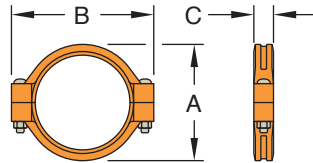

Grooved Couplings

Pipe Size		Max. † Pressures kPa psi	Max. † End Load N Lbs.	Max. * ‡ End Gap mm Inches	Deflection ‡		Dimensions - mm Inches			Coupling Bolts Size (Qty 2) mm Inches	Approx. Weight kg Lbs.
Nominal mm Inches	O.D. mm Inches				Degrees Per Coupling	mm/m Inches/Ft	A	B	C		
<b>25</b>	<b>33.7</b>	<b>3,447</b>	<b>3,021</b>	<b>3.3</b>							
1	1.315	500	679	0.13	5° 26'	98.4	60.5	101.6	46.0	M12 x 89	0.9
						1.14	2.38	4.00	1.81	½ x 3	2.0
<b>32</b>	<b>42.4</b>	<b>3,447</b>	<b>4,814</b>	<b>3.3</b>							
1-¼	1.660	500	1,082	0.13	4° 19'	75.0	70.0	111.0	46.0	M12 x 89	1.0
						0.90	2.76	4.37	1.81	½ x 3	2.2
<b>40</b>	<b>48.3</b>	<b>3,447</b>	<b>6,803</b>	<b>3.3</b>							
1-½	1.900	500	1,418	0.13	3° 46'	65.8	75.4	117.6	46.0	M12 x 89	1.1
						0.79	2.97	4.63	1.81	½ x 3	2.5
<b>50</b>	<b>60.3</b>	<b>3,447</b>	<b>9,853</b>	<b>3.3</b>							
2	2.375	500	2,215	0.13	3° 1'	52.5	89.9	133.4	47.8	M12 x 89	1.4
						0.63	3.54	5.25	1.88	½ x 3	3.0
<b>65</b>	<b>73.0</b>	<b>3,447</b>	<b>14,439</b>	<b>3.3</b>							
2-½	2.875	500	3,246	0.13	2° 29'	43.3	103.1	146.1	47.8	M12 x 89	1.6
						0.52	4.06	5.75	1.88	½ x 3	3.5
<b>65</b>	<b>76.1</b>	<b>2,068</b>	<b>9,435</b>	<b>3.3</b>							
76.1mm	3.000	300	2,121	0.13	2° 23'	41.7	106.4	146.1	47.8	M12 x 89	1.8
						0.50	4.19	5.75	1.88		4.0
<b>80</b>	<b>88.9</b>	<b>3,447</b>	<b>21,400</b>	<b>3.3</b>							
3	3.500	500	4,811	0.13	2° 3'	35.8	119.1	162.1	47.8	M12 x 89	1.8
						0.43	4.69	6.38	1.88	½ x 3	4.0
<b>100</b>	<b>114.3</b>	<b>3,447</b>	<b>35,372</b>	<b>6.4</b>							
4	4.500	500	7,952	0.25	3° 11'	55.8	151.1	209.6	52.3	M16 x 83	3.2
						0.67	5.95	8.25	2.06	5/8 x 3-¼	7.0
<b>125</b>	<b>139.7</b>	<b>3,447</b>	<b>52,841</b>	<b>6.4</b>							
139.7mm	5.500	500	11,879	0.25	2° 30'	43.6	178.3	254.0	51.8	M20 x 121	3.8
						0.52	7.02	10.00	2.04	¾ x 4-¾	8.3
<b>125</b>	<b>141.3</b>	<b>3,447</b>	<b>54,059</b>	<b>6.4</b>							
5	5.563	500	12,153	0.25	2° 35'	45.1	179.8	254.0	52.3	M20 x 121	4.5
						0.54	7.08	10.00	2.06	¾ x 4-¾	10.0
<b>150</b>	<b>165.1</b>	<b>2,068</b>	<b>44,282</b>	<b>6.4</b>							
165.1mm	6.500	300	9,955	0.25	2° 12'	38.4	208.0	285.8	52.3	M20 x 121	5.4
						0.46	8.19	11.25	2.06		12.0
<b>150</b>	<b>168.3</b>	<b>3,447</b>	<b>76,670</b>	<b>6.4</b>							
6	6.625	500	17,236	0.25	2° 10'	37.8	210.8	285.8	52.3	M20 x 121	5.0
						0.45	8.30	11.25	2.06	¾ x 4-¾	11.1
<b>200</b> ▶	<b>219.1</b>	<b>3,447</b>	<b>129,946</b>	<b>6.4</b>							
8	8.625	500	29,213	0.25	1° 40'	29.2	271.3	355.6	62.7	M22 x 165	9.7
						0.35	10.68	14.00	2.47	7/8 x 6-½	21.4
<b>250</b> ▶	<b>273.0</b>	<b>3,447</b>	<b>201,864</b>	<b>6.4</b>							
10	10.750	500	45,381	0.25	1° 20'	23.3	331.7	417.6	66.8	M24 x 165	13.2
						0.28	13.06	16.44	2.63	1 x 6-½	29.0
<b>300</b> ▶	<b>323.9</b>	<b>3,447</b>	<b>283,966</b>	<b>6.4</b>							
12	12.750	500	63,838	0.25	1° 7'	19.5	390.9	478.5	66.8	M24 x 165	16.8
						0.23	15.39	18.84	2.63	1 x 6-½	37.0

\* Maximum available gap between pipe ends. Minimum gap = 0.

† Maximum pressure and end load are total from all loads based on standard weight steel pipe. Pressure ratings and end loads may differ for other pipe materials and/or wall thicknesses. Contact GRINNELL Products for details.

‡ Max end gap and deflection is for cut grooved standard weight pipe. Values for roll grooved pipe will be half that of cut grooved.

• Only available in ANSI bolt sizes.

▶ Sizes are available to JIS standards. Contact GRINNELL Products for details.

For information on larger sizes, Chinese sizes or other alternative sizes, contact GRINNELL Products.

See page 13 for general notes, and see pages 76 - 78 for gasket information.

## Figure 716 Flexible Reducing Couplings

Tech Data Sheet: TFP1830

**10**  
YEAR  
LIMITED  
WARRANTY

The GRINNELL Figure 716 Flexible Reducing Coupling allows for a direct transition between two different pipe sizes and replaces two couplings and a reducing fitting. It is capable of pressures up to 3,447 kPa (500 psi) depending on pipe size and wall thickness. A flexible reducing coupling is not recommended for low-temperature applications.

Grooved  
Couplings

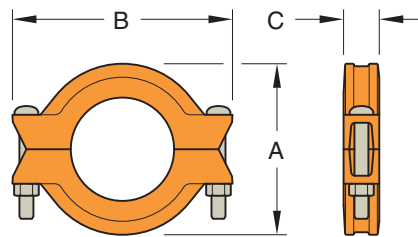

Pipe Size		Max.† Pressures kPa psi	Max.† End Load N/Lbs.	Max.*‡ End Gap mm Inches	Deflection ‡		Dimensions mm Inches			Coupling Bolts Size (Qty 2) mm Inches	Approx. Weight kg Lbs.
Nominal mm Inches	O.D. mm Inches				Degrees Per Coupling	mm/m Inches/Ft	A	B	C		
50 x 40 2 x 1-1/2	60.3 x 48.3 2.375 x 1.900	2,413 350	4,412 992	3.3 0.13	1° 53'	32.9 0.39	88.9 3.50	128.5 5.06	47.8 1.88	M10 x 57 3/8 x 2-1/4	1.3 2.8
65 x 50 2-1/2 x 2	73.0 x 60.3 2.875 x 2.375	2,413 350	6,894 1,550	3.3 0.13	1° 33'	27.1 0.32	101.6 4.00	139.7 5.50	47.8 1.88	M120 x 57 3/8 x 2-1/4	1.5 3.3
65 x 50 76.1mm x 2	76.1 x 60.3 3.000 x 2.375	2,413 350	6,894 1,550	3.3 0.13	1° 34'	27.3 0.33	106.4 4.19	149.4 5.88	47.8 1.88	M12 x 89	1.5 3.3
80 x 50 3 x 2	88.9 x 60.3 3.500 x 2.375	2,413 350	6,894 1,550	3.3 0.13	1° 17'	22.4 0.27	119.1 4.69	165.1 6.50	47.8 1.88	M12 x 89 1/2 x 3	2.0 4.3
80 x 65 3 x 2-1/2	88.9 x 73.0 3.500 x 2.875	2,413 350	10,101 2,271	3.3 0.13	1° 17'	22.4 0.27	119.1 4.69	165.1 6.50	47.8 1.88	M12 x 89 1/2 x 3	1.8 3.9
80 x 65 3 x 76.1mm	88.9 x 76.1 3.500 x 3.000	2,413 350	11,004 2,474	3.3 0.13	1° 17'	22.4 0.27	119.1 4.69	165.1 6.50	47.8 1.88	M12 x 89	1.9 4.2
100 x 60 4 x 2	114.3 x 60.3 4.500 x 2.375	2,413 350	6,894 1,550	4.8 0.19	2° 38'	46.0 0.55	152.4 6.00	206.5 8.13	50.8 2.00	M16 x 83 5/8 x 3-1/4	2.4 5.2
100 x 65 4 x 2-1/2	114.3 x 73.0 4.500 x 2.875	2,413 350	10,101 2,271	4.8 0.19	2° 38'	46.0 0.55	152.4 6.00	206.5 8.13	50.8 2.00	M16 x 83 5/8 x 3-1/4	3.0 6.7
100 x 65 4 x 76.1mm	114.3 x 76.1 4.500 x 3.000	2,413 350	11,004 2,474	4.8 0.19	2° 38'	46.0 0.55	152.4 6.00	206.5 8.13	50.8 2.00	M16 x 83	2.8 6.2
100 x 80 4 x 3	114.3 x 88.9 4.500 x 3.500	2,413 350	14,972 3,366	4.8 0.19	2° 38'	46.0 0.55	152.4 6.00	206.5 8.13	50.8 2.00	M16 x 83 5/8 x 3-1/4	2.8 6.2
125 x 100 139.7mm x 4	139.7 x 114.3 5.500 x 4.500	2,413 350	24,749 5,564	6.4 0.25	2° 38'	46.0 0.55	179.3 7.06	241.3 9.50	52.3 2.06	M20 x 121	4.4 9.6
125 x 100 5 x 4	141.3 x 114.3 5.563 x 4.500	2,413 350	24,749 5,564	6.4 0.25	2° 5'	36.4 0.44	181.1 7.13	242.8 9.56	52.3 2.06	M20 x 121 3/4 x 4-3/4	4.4 9.6
150 x 100 165.1mm x 4	165.1 x 114.3 6.500 x 4.500	2,068 300	21,221 4,771	6.4 0.25	1° 50'	32.0 0.38	207.8 8.18	274.6 10.81	52.3 2.06	M20 x 121	5.8 12.8
150 x 100 6 x 4	168.3 x 114.3 6.625 x 4.500	2,068 300	21,213 4,769	6.4 0.25	1° 44'	30.0 0.36	212.9 8.38	276.4 10.88	52.3 2.06	M20 x 121 3/4 x 4-3/4	5.8 12.8
150 x 125 6 x 5	168.3 x 141.3 6.625 x 5.563	2,068 300	32,417 7,288	6.4 0.25	1° 44'	30.0 0.36	212.9 8.38	276.4 10.88	52.3 2.06	M20 x 121 3/4 x 4-3/4	6.3 13.8
200 x 150 8 x 6	219.1 x 168.3 8.625 x 6.625	2,068 300	45,975 10,336	6.4 0.25	1° 15'	21.0 0.26	271.5 10.69	349.3 13.75	57.2 2.25	M22 x 165 7/8 x 6-1/2	9.1 20.0

\* Maximum available gap between pipe ends. Minimum gap = 0.

† Maximum pressure and end load are total from all loads based on standard weight steel pipe. Pressure ratings and end loads may differ on other pipe materials and/or wall thickness. Contact GRINNELL Products for details.

‡ Max end gap and deflection is for cut grooved standard weight pipe. Values for roll grooved pipe will be half that of cut grooved.

For information on larger sizes, contact GRINNELL Products.

See page 13 for general notes, and see pages 76 - 78 for gasket information.

## Figure 770 High Pressure Rigid Couplings

Tech Data Sheet: G138

The Figure 770 Rigid Coupling provides a rigid joint by firmly gripping along the circumference of the pipe grooves. This coupling offers a dependable method for joining pipe and is an economical alternative to welding, threading, or using flanges. It is capable of pressures up to 6,895 kPa (1000 psi) depending on pipe size and wall thickness.

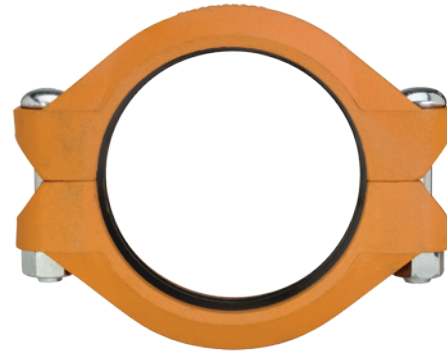
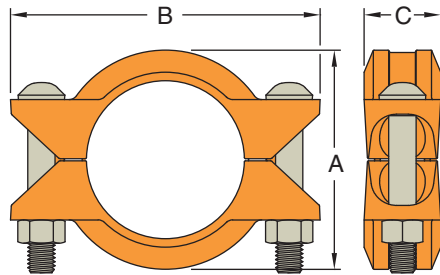

Grooved  
Couplings

Pipe Size		Max. † Pressures kPa psi	Max. † End Load kN Lbs.	Max. * ‡ End Gap mm Inches	Dimensions - mm Inches			Coupling Bolts Size (Qty 2) mm Inches	Approx. Weight kg Lbs.
Nominal mm Inches	O.D. mm Inches				A	B	C		
<b>50</b>	<b>60.3</b>	<b>6895</b>	<b>19.71</b>	<b>3.6</b>	<b>89.7</b>	<b>145.3</b>	<b>47.8</b>	<b>M16 x 70</b>	<b>1.5</b>
2	2.375	1000	4,430.1	0.14	3.53	5.72	1.88	5/8 x 2-3/4	3.4
<b>65</b>	<b>73.0</b>	<b>6895</b>	<b>28.88</b>	<b>3.6</b>	<b>103.1</b>	<b>152.4</b>	<b>47.8</b>	<b>M16 x 89</b>	<b>1.8</b>
2-1/2	2.875	1000	6,491.8	0.14	4.06	6.00	1.88	5/8 x 3-1/2	4.0
<b>80</b>	<b>88.9</b>	<b>6895</b>	<b>42.79</b>	<b>3.6</b>	<b>121.4</b>	<b>171.7</b>	<b>47.8</b>	<b>M16 x 89</b>	<b>2.4</b>
3	3.500	1000	9,621.1	0.14	4.78	6.76	1.88	5/8 x 3-1/2	5.3
<b>100</b>	<b>114.3</b>	<b>6895</b>	<b>70.74</b>	<b>6.4</b>	<b>152.7</b>	<b>215.9</b>	<b>53.3</b>	<b>M20 x 108</b>	<b>3.3</b>
4	4.500	1000	15,904.3	0.25	6.01	8.50	2.10	3/4 x 4-1/4	7.3
<b>150</b>	<b>168.3</b>	<b>6895</b>	<b>153.33</b>	<b>6.4</b>	<b>216.2</b>	<b>285.8</b>	<b>53.3</b>	<b>M22 x 140</b>	<b>6.8</b>
6	6.625	1000	34,471.6	0.25	8.51	11.25	2.10	7/8 x 5-1/2	15.0
<b>200</b>	<b>219.1</b>	<b>5516</b>	<b>207.90</b>	<b>6.4</b>	<b>277.6</b>	<b>349.3</b>	<b>66.0</b>	<b>M24 x 140</b>	<b>11.3</b>
8	8.625	800	46,741.0	0.25	10.93	13.75	2.60	1 x 5-1/2	25.0
<b>250</b>	<b>273.0</b>	<b>5516</b>	<b>322.97</b>	<b>6.4</b>	<b>341.9</b>	<b>406.4</b>	<b>66.0</b>	<b>M24 x 165</b>	<b>15.4</b>
10	10.750	800	72,610.1	0.25	13.46	16.00	2.60	1 x 6-1/2	34.0
<b>300</b>	<b>323.9</b>	<b>5516</b>	<b>454.32</b>	<b>6.4</b>	<b>394.2</b>	<b>457.2</b>	<b>66.0</b>	<b>M24 x 165</b>	<b>18.1</b>
12	12.750	800	102,141.0	0.25	15.52	18.00	2.60	1 x 6-1/2	40.0

◆ Contact GRINNELL for dimension details.

\* Maximum available gap between pipe ends. Minimum gap = 0.

† Maximum pressure and end load are total from all loads based on standard weight steel pipe. Pressure ratings and end loads may differ for other pipe materials and/or wall thickness. Contact GRINNELL Products for details.

‡ Max end gap and deflection is for cut grooved standard weight pipe. Values for roll grooved pipe will be half that of cut grooved.

For information on larger sizes, contact GRINNELL Products.

See page 13 for general notes, and see pages 76 - 78 for gasket information.

## Figure 702 Outlet Couplings

(Page 1 of 2)

Tech Data Sheet: G220



The GRINNELL Figure 702 Outlet Coupling has the combined features of a coupling and a reducing outlet, eliminating the need for a mechanical tee or other associated couplings. The coupling is available in grooved, male-threaded, or female-threaded outlets. This design makes installation faster, safer, and more cost effective on the job site.

Additional features:

- Available in sizes 40mm - 150mm (1 1/2" to 6")
- Rated for pressures up to 3,447 kPa (500 psi)
- Suitable for vacuum service up to 254mm HG (10" HG)

Grooved Couplings

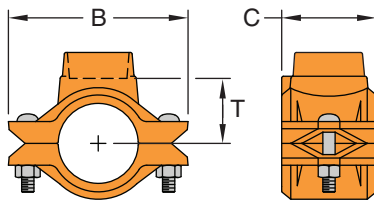

Figure 702  
Outlet Coupling with Female Threaded Outlet

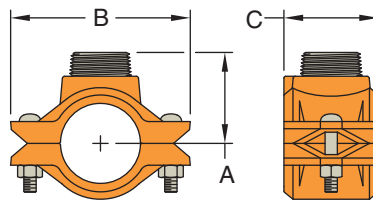

Figure 702  
Outlet Coupling with Male Threaded Outlet

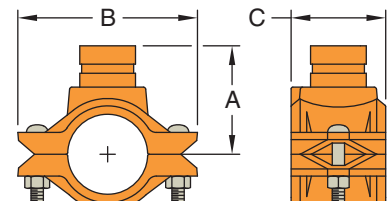

Figure 702  
Outlet Coupling with Grooved Outlet

Run Pipe Size		Branch Size				End Gap Range mm Inches	Max. Run End Load kN Lbs.	Dimensions mm Inches				Coupling Bolt Size Inches	Approx. Weight kg Lbs.
Nominal mm Inches	O.D. mm Inches	Female Thread mm Inches	Male Thread mm Inches	Grooved				A	B	C	T		
				Nominal mm Inches	O.D. mm Inches								
40 1-1/2	48.3 1.900	21.3	-	-	-	20-22	6.3 1418	-	114.3	70.0	52.0	3/8 x 2-1/8 •	1.2
		1/2	-	-	-	0.81-0.88		-	4.50	2.75	2.06		2.6
		26.7	-	-	-	20-22		-	114.3	70.0	52.0		1.2
		3/4	-	-	-	0.81-0.88		-	4.50	2.75	2.06		2.6
50 2	60.3 2.375	33.7	-	-	-	20-22	9.9 2215	-	114.3	70.0	49.0	3/8 x 2-1/8 •	1.3
		1	-	-	-	0.81-0.88		-	4.50	2.75	1.94		2.9
		21.3	-	-	-	20-22		-	127.0	70.0	59.0		1.4
		1/2	-	-	-	0.81-0.88		-	5.00	2.75	2.32		3.1
65 2-1/2	73.0 2.875	26.7	-	-	-	20-22	14.4 3246	-	127.0	70.0	59.0	1/2 x 2-3/8 •	1.4
		3/4	-	-	-	0.81-0.88		-	5.00	2.75	2.32		3.1
		33.7	33.7	25	33.7	20-22		89.0	127.0	70.0	56.0		1.5
		1	1	1	1.315	0.81-0.88		3.50	5.00	2.75	2.20		3.3
		21.3	-	-	-	32-38		-	161.0	83.0	56.0		2.2
		1/2	-	-	-	1.25-1.50		-	6.33	3.25	2.20		4.8
65 2-1/2	73.0 2.875	26.7	-	-	-	32-38	14.4 3246	-	161.0	83.0	65.0	1/2 x 2-3/8 •	2.1
		3/4	-	-	-	1.25-1.50		-	6.33	3.25	2.56		4.6
		33.7	-	-	-	32-38		-	161.0	83.0	62.0		4.4
		1	-	-	-	1.25-1.50		-	6.33	3.25	2.44		2.2
		42.4	42.4	32	42.4	32-38		94.0	161.0	83.0	-		2.3
		1-1/4	1-1/4	1-1/4	1.660	1.25-1.50		3.70	6.33	3.25	-		5.1
48.3	48.3	40	48.3	32-38	94.0	161.0	83.0	-	5.9				
1-1/2	1-1/2	1-1/2	1.900	1.25-1.50	3.70	6.33	3.25	-	2.4				

## Figure 702 Outlet Couplings

(Page 2 of 2)

Tech Data Sheet: G220

**10**  
YEAR  
LIMITED  
WARRANTY

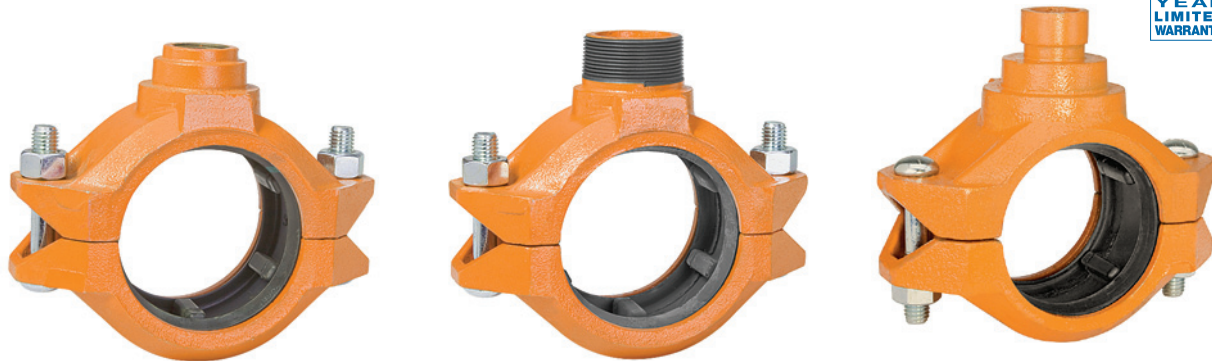

Grooved  
Couplings

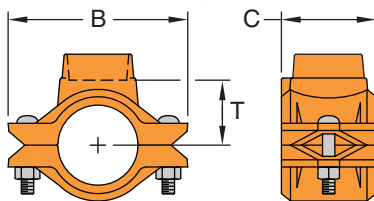

Figure 702  
Outlet Coupling with Female Threaded Outlet

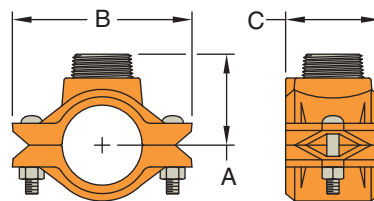

Figure 702  
Outlet Coupling with Male Threaded Outlet

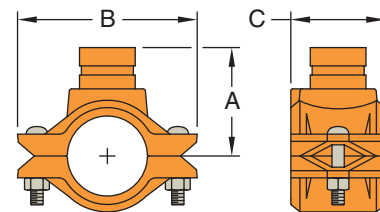

Figure 702  
Outlet Coupling with Grooved Outlet

Run Pipe Size		Branch Size				End Gap Range mm Inches	Max. Run End Load kN Lbs.	Dimensions mm Inches				Coupling Bolt Size Inches	Approx. Weight kg Lbs.	
Nominal mm Inches	O.D. mm Inches	Female Thread mm Inches	Male Thread mm Inches	Grooved Nominal mm Inches	O.D. mm Inches			A	B	C	T			
80 3	88.9 3.500	26.7 ¾	-	-	-	32-38 1.25-1.50	21.4 4811	-	175.0 6.87	83.0 3.25	72.0 2.83	½ x 3•	2.7 5.9	
		33.7 1	33.4 1	25 1	33.7 1.315	32-38 1.25-1.50		102.0 4.00	175.0 6.87	83.0 3.25	70.0 2.75		2.8 6.2	
		42.4 1¾	-	-	-	♦		♦	♦	♦	♦		♦	♦
		48.3 1½	48.3 1½	40 1½	48.3 1.900	32-38 1.25-1.50		102.0 4.00	175.0 6.87	83.0 3.25	-		-	2.9 6.4
		♦	-	-	-	♦		♦	♦	♦	♦		♦	♦
100 4	114.3 4.500	26.7 ¾	-	♦	♦	41-46 1.63-1.81	35.4 7952	♦	211.0 8.31	93.0 3.66	94.0 3.70	⅝ x 3½•	4.2 9.2	
		33.7 1	-	♦	♦	41-46 1.63-1.81		♦	211.0 8.31	93.0 3.66	91.0 3.58		4.3 9.5	
		48.3 1½	48.3 1½	40 1½	48.3 1.900	41-46 1.63-1.81		124.0 4.88	211.0 8.31	93.0 3.66	84.0 3.31		4.3 9.5	
		60.3 2	60.3 2	50 2	60.3 2.375	41-46 1.63-1.81		124.0 4.88	211.0 8.31	93.0 3.66	-		-	4.5 9.9
		♦	-	-	-	♦		♦	♦	♦	♦		♦	♦
150 6	168.3 6.625	33.7 1	-	25 1	33.7 1.315	41-46 1.63-1.81	76.7 17,235	-	276.0 10.86	94.0 3.70	121.0 4.76	⅝ x 3½•	6.0 13.2	
		-	-	32 1¾	42.4 1.660	♦		♦	♦	♦	♦		♦	
		48.3 1½	48.3 1½	40 1½	48.3 1.900	41-46 1.63-1.81		154.0 6.06	276.0 10.86	94.0 3.70	121.0 4.76		6.2 13.6	
		60.3 2	60.3 2	50 2	60.3 2.375	41-46 1.63-1.81		154.0 6.06	276.0 10.86	94.0 3.70	-		-	6.5 14.3
		♦	-	-	-	♦		♦	♦	♦	♦		♦	♦

■ Threads are BSP. Some size outlets are available with NPT threads. Contact GRINNELL Products for details.

• Only available in ANSI bolt sizes.

♦ Contact GRINNELL for dimension details.

For information on larger sizes, contact GRINNELL Products.

See page 13 for general notes, and see pages 76 - 78 for gasket information.

## Figure 71 Flange Adaptors (PN10/PN16)

(Page 1 of 4)

Tech Data Sheet: TFP1880



For Fire Protection Pressure Rating and Listing / Approval information contact Tyco Fire Protection Products.

Grooved Couplings

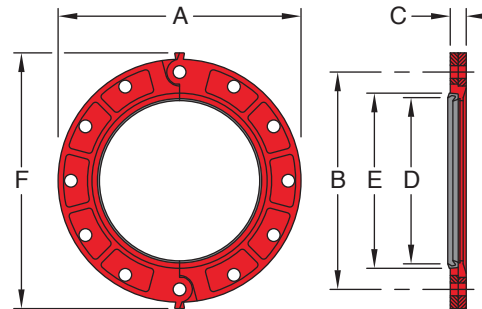

Pipe Size		PN10/ PN16	Max † End Load N Lbs.	Dimensions - mm Inches						Recommended Flange Mating Bolts ‡		Approx. Wt. kg Lbs
Nominal mm Inches	O.D. mm Inches			A	B	C	*D	*E	F	Size Dia. x Lg mm Inches	Qty.	
50 2	60.3 2.375	PN10 / PN16	5889 1,324	162.1 6.38	125.0 4.92	19.1 0.75	60.5 2.38	86.6 3.41	184.2 7.25	M16 x 76	4	1.8 4.0
65 2½	73.0 2.875	PN10 / PN16	8665 1,948	177.8 7.00	139.7 5.50	22.4 0.88	73.6 2.88	99.3 3.91	130.3 5.13	M16 x 76	4	2.4 5.4
65** 76.1mm	76.1 3.000	PN10	8665 1,948	184.9 7.28	145.0 5.71	22.4 0.88	76.1 3.00	102.4 4.03	205.5 8.09	M16 x 76	4	2.6 5.7
65** 76.1mm	76.1 3.000	PN16	8665 1,948	184.9 7.28	144.8 5.70	22.4 0.88	76.1 3.00	102.4 4.03	205.2 8.08	M16 x 76	4	2.5 5.6
80 3**	88.9 3.500	PN10	12,838 2,886	184.4 7.26	146.3 5.76	23.9 0.94	88.9 3.50	115.1 4.53	199.6 7.86	M16 x 76	4	2.4 5.4
80 3**	88.9 3.500	PN16	12,838 2,886	200.2 7.88	160.0 6.30	23.9 0.94	88.9 3.50	115.1 4.53	222.5 8.76	M16 x 76	8	2.5 5.6
100 4**	114.3 4.500	PN10	21,222 4,771	215.9 8.50	177.8 7.00	23.9 0.94	114.3 4.50	140.5 5.53	235.2 9.26	M16 x 76	8	3.5 7.8
100 4**	114.3 4.500	PN16	21,222 4,771	219.9 8.66	180.1 7.09	23.9 0.94	114.3 4.50	140.5 5.53	239.5 9.43	M16 x 76	8	3.6 8.0
125** 139.7mm	139.7 5.500	PN10	32,436 7,292	249.9 9.84	210.1 8.27	25.4 1.00	139.7 5.50	165.9 6.53	271.5 10.69	M16 x 89	8	4.2 9.2
125** 139.7mm	139.7 5.500	PN16	31,702 7,127	249.9 9.84	209.8 8.26	24.5 1.00	139.7 5.50	169.2 6.66	310.4 12.22	M16 x 89	8	4.2 9.2
150** 165.1mm	165.1 6.500	PN10	44,282 9,955	279.4 11.00	234.2 9.26	24.5 1.00	165.1 6.50	194.6 7.66	298.7 11.76	M20 x 89	8	4.7 10.4
150** 165.1mm	165.1 6.500	PN16	44,282 9,955	285.0 11.22	240.3 9.46	24.5 1.00	165.1 6.50	194.6 7.66	307.3 12.10	M20 x 89	8	4.8 10.5

## Figure 71 Flange Adaptors (PN10/PN16)

(Page 2 of 4)

Tech Data Sheet: TFP1880

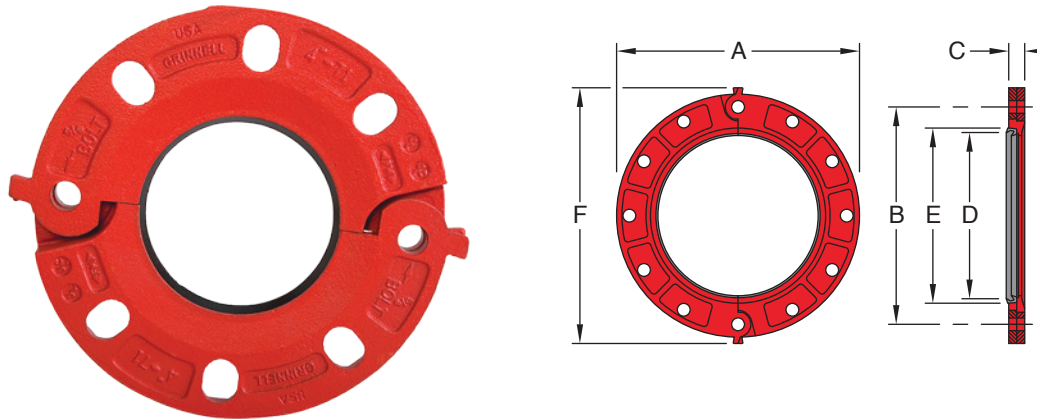

Grooved  
Couplings

Pipe Size		PN10/ PN16	Max † End Load N Lbs.	Dimensions - mm Inches						Recommended Flange Mating Bolts ‡		Approx. Wt. kg Lbs
Nominal mm Inches	O.D. mm Inches			A	B	C	*D	*E	F	Size Dia. x Lg mm Inches	Qty.	
150 6	168.3 6.625	PN10 / PN16	77,968 17,528	279.4 11.00	241.1 9.49	25.4 1.00	168.1 6.62	197.6 7.78	301.8 11.88	M20 x 89	8	4.8 10.6
200 8**	219.1 8.625	PN10	77,968 17,528	336.8 13.26	292.1 11.50	28.6 1.125	218.9 8.62	254.5 9.94	358.6 14.12	M20 x 89	8	6.9 15.4
200 8**	219.1 8.625	PN16	77,968 17,528	339.8 13.38	295.1 11.62	28.6 1.125	218.9 8.62	254.5 9.94	362.7 14.28	M20 x 89	12	7.5 16.6
250 10**	273.0 10.750	PN10	121,121 27,229	395.2 15.56	350.0 13.78	30.2 1.188	273.1 10.75	312.4 12.31	419.1 16.50	M20 x 102	12	9.6 21.2
250 10**	273.0 10.750	PN16	170,380 38,303	406.4 16.00	355.1 13.98	30.2 1.188	273.1 10.75	312.7 12.31	428.8 16.88	M22 x 102	12	10.2 22.5
300 12**	323.9 12.750	PN10	170,380 38,303	445.0 17.52	399.8 15.74	31.8 1.25	323.9 12.75	363.5 14.31	470.4 18.52	M22 x 102	12	11.2 24.8
300 12**	323.9 12.750	PN16	170,380 38,303	460.2 18.12	410.0 16.14	31.8 1.25	323.9 12.75	363.5 14.31	486.2 19.14	M22 x 102	12	13.1 28.9

Maximum Pressure rating is 2068 kPa (300 psi).

\* Dimensions D and E represent minimum and maximum sealing surfaces.

\*\* For noted sizes, PN10 and PN16 dimensional values differ.

† Maximum end load is total from all loads based on standard weight steel pipe. Pressure ratings and end loads may differ on other pipe materials and/or wall thickness. Contact GRINNELL Products for details.

‡ Mating Bolts and Nuts are not supplied. Flange Mating Bolts must be at least SAE J429, Grade 5 or stronger. Bolt lengths are standard; responsibility lies with the purchaser to verify the correct length for the intended application.

For information on larger sizes, contact GRINNELL Products.

See page 13 for general notes, and see pages 76 - 78 for gasket information.

See page 26 for flange washer Adaptor and page 96 flange drilling specifications

## Figure 71 Flange Adaptors (ANSI Class 125/150)

(Page 3 of 4)

Tech Data Sheet: TFP1880



The Figure 71 Flange Adaptor is capable of pressures up to 2,068 kPa (300 psi) depending on pipe size and wall thickness. It provides a direct transition from flanged components to a grooved piping system. I.P.S. size flange bolt patterns conform to ANSI Class 125 and 150.

The gasket seal is designed with an optimal amount of rubber to provide a dependable seal and to avoid the gasket pocket from overfilling, which may cause assembly difficulties.

Grooved Couplings

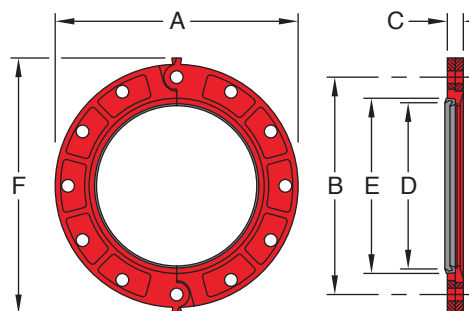

For Fire Protection Pressure Rating and Listing / Approval information contact Tyco Fire Protection Products.

Pipe Size		Max † Pressure kPa psi	Max End Load † N Lbs.	Dimensions - mm Inches						Recommended Flange Mating Bolts ‡		Approx. Wt. kg Lbs
Nominal mm Inches	O.D. mm Inches			A	B	C	*D	*E	F	Size Dia. x Lg mm Inches	Qty.	
50	60.3	2068	5889	162.1	120.7	19.1	60.5	86.6	184.2	5/8 x 3	4	1.9
2	2.375	300	1,324	6.38	4.75	0.75	2.38	3.41	7.25		4.1	
65	73.0	2068	8665	178.0	140.0	22.0	73.0	99.0	200.0	5/8 x 3	4	2.4
2-1/2	2.875	300	1,948	7.00	5.50	0.88	2.88	3.91	7.88		5.4	
65	76.1	2068	9435	184.9	145.0	22.0	76.1	102.4	205.2	5/8 x 3	4	2.6
76.1mm	3.000	300	2,121	7.28	5.71	0.88	3.00	4.03	8.08		5.8	
80	88.9	2068	12,838	190.5	152.4	23.9	88.9	115.1	251.0	5/8 x 3	4	2.7
3	3.500	300	2,886	7.50	6.00	0.94	3.50	4.53	9.88		6.0	
100	114.3	2068	21,222	228.6	190.5	23.9	114.3	140.5	251.5	5/8 x 3	8	3.7
4	4.500	300	4,771	9.00	7.50	0.94	4.50	5.53	9.90		8.1	
125	139.7	2068	31,702	249.9	210.1	25.4	139.7	169.2	270.3	3/4 x 3-1/2	8	4.2
139.7mm	5.500	300	7,127	9.84	8.27	1.00	5.50	6.66	10.64		9.2	
125	141.3	2068	32,436	254.0	215.9	25.4	141.2	170.7	289.1	3/4 x 3-1/2	8	4.2
5	5.563	300	7,292	10.00	8.50	1.00	5.56	6.72	11.38		9.2	
150	165.1	2068	44,282	285.0	240.6	25.4	165.1	194.6	307.3	3/4 x 3-1/2	8	5.0
165.1mm	6.500	300	9,955	11.22	9.45	1.00	6.50	7.66	12.10		11.0	
150	168.3	2068	45,999	279.4	241.3	25.4	168.1	197.6	301.8	3/4 x 3-1/2	8	4.8
6	6.625	300	10,341	11.00	9.50	1.00	6.62	7.78	11.88		10.5	
200	219.1	2068	77,968	342.9	298.5	28.7	218.9	252.5	365.3	3/4 x 3-1/2	8	7.3
8	8.625	300	17,528	13.50	11.75	1.13	8.62	9.94	14.38		16.2	
250	273.0	2068	121,121	406.4	362.0	30.2	273.1	312.7	428.8	7/8 x 4	12	9.4
10	10.750	300	27,229	16.00	14.25	1.19	10.75	12.31	16.88		20.7	
300	323.9	2068	170,380	482.6	431.8	31.8	323.9	363.5	508.0	7/8 x 4	12	14.4
12	12.750	300	38,303	19.00	17.00	1.25	12.75	14.31	20.00		31.8	

\* Dimensions D and E represent minimum and maximum sealing surfaces.

\*\* For segment bolt torque recommendations, refer to Table A below.

• Metric segment bolt are available upon request.

† Maximum pressure and end load are total from all loads based on standard weight steel pipe. Pressure ratings and end loads may differ on other pipe materials and/or wall thickness. Contact GRINNELL Products for details.

‡ Mating bolts and nuts are not supplied. Flange mating bolts must be at least SAE J429, Grade 5 or stronger. Bolt lengths are standard; responsibility lies with the purchaser to verify the correct length for the intended application.

For information on larger sizes, contact GRINNELL Products.

See page 13 for general notes, and see pages 76 - 78 for gasket information.

See page 26 for flange washer Adaptor and page 96 flange drilling specifications



## Figure 71 Flange Adapters (AS2129 Table E)

The Figure 71 Flange Adapter is capable of pressures up to 300 *psi* (20,7 *bar*) depending on pipe size and wall thickness. It provides a direct transition from flanged components to a grooved piping system. I.P.S. size flange bolt patterns conform to AS2129 Table E.

(Page 4 of 4)

Tech Data Sheet: TFP1880

The gasket seal is designed with an optimal amount of rubber to provide a dependable seal and to avoid the gasket pocket from overfilling, which may cause assembly difficulties.

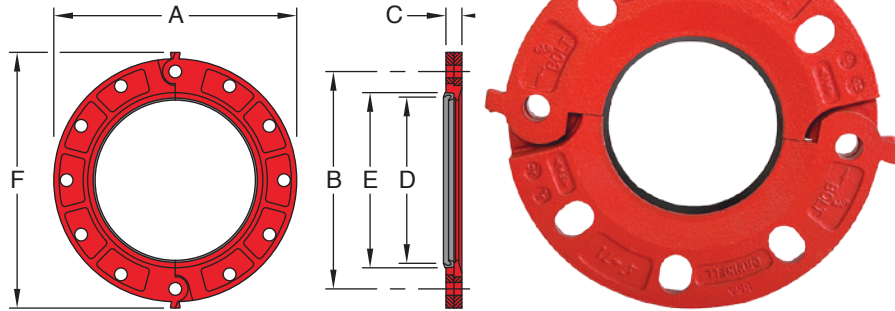

Grooved Couplings

Pipe Size		Max End Load † N Lbs.	Dimensions - mm Inches						Recommended Flange Mating Bolts ‡			Approx. Wt. kg Lbs
Nominal mm Inches	O.D. mm Inches		A	B	C	*D	*E	F	Size Dia. x Lg mm Inches	Qty.	Bolt Torque Range Nm Lbs.-ft.	
80	88,9	12,838	200,2	160,0	23,9	88,9	115,1	222,3	M16 x 76	8	149-190	2,9
3	3.500	2,886	7.88	6.30	0.94	3.50	4.53	8.75	—	8	—	6.4
100	114,3	21,222	228,6	180,1	23,9	114,3	140,5	251,5	M16 x 76	8	—	7.7
4	4.500	4,771	9.00	7.09	0.94	4.50	5.53	9.90	—	8	149-190	3,5
125	139.7	♦	♦	♦	♦	♦	♦	♦	♦	♦	♦	♦
139.7mm	5.500	♦	♦	♦	♦	♦	♦	♦	♦	♦	♦	♦
150	165.1	♦	♦	♦	♦	♦	♦	♦	♦	♦	♦	♦
165.1mm	6.500	♦	♦	♦	♦	♦	♦	♦	♦	♦	♦	♦
200	219.1	121,121	339,9	294,9	28,7	218,9	252,5	363,5	M20 x 89	12	298-339	6,8
8	8.625	27,229	13.38	11.61	1.13	8.62	9.94	14.31	—	—	—	15.0

♦ Contact GRINNELL for dimension details.

\* Dimensions D and E represent minimum and maximum sealing surfaces.

† Maximum End Load is total from all loads based on standard weight steel pipe. Pressure ratings and end loads may differ on other pipe materials and/or wall thickness. Contact GRINNELL Products for details.

‡ Mating Bolts and Nuts are not supplied. Flange Mating Bolts must be at least SAE J429, Grade 5 or stronger. Bolt lengths are standard; responsibility lies with the purchaser to verify the correct length for the intended application.

Maximum Pressure rating is 300 *psi* (20,7 *bar*).

For information on larger sizes, contact GRINNELL Products.

See page 13 for general notes, and see pages 76 - 78 for gasket information.

See page 26 for Flange Adapter Washers and page 96 Flange Drilling Specifications.

## Flange Adaptor Washers

Carbon steel Flange Adapter Washers are required when the Figure 71 Flange Adapter is used against surfaces such as:

- Rubber surfaces
- Adapting to AWWA cast flanges
- Rubber faced wafer valves
- Serrated flange surfaces

Contact Tyco Technical Services for additional information.

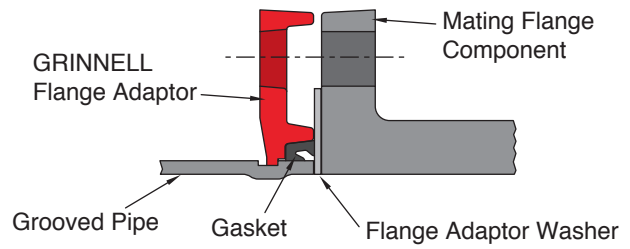

Grooved Couplings

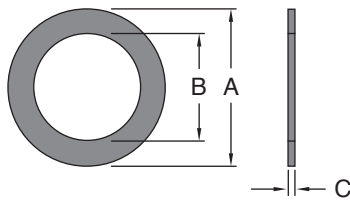

Pipe Size		Dimensions - mm Inches		
Nominal mm Inches	O.D. mm Inches	A	B	C
50 2	60.3 2.375	100.1 3.94	57.2 2.25	3.0 0.12
65 2½	73.0 2.875	119.1 4.69	69.9 2.75	3.0 0.12
65 76,1mm	76.1 3.000	124.2 4.89	73.2 2.88	3.0 0.12
80 3	88.9 3.500	131.8 5.19	85.9 3.38	3.0 0.12
100 4	114.3 4.500	169.9 6.69	111.3 4.38	3.0 0.12
125 139,7mm	139.7 5.500	189.2 7.45	135.1 5.32	3.0 0.12
125 5	141.3 5.563	192.0 7.56	136.7 5.38	3.0 0.12
150 165,1mm	165.1 6.500	215.1 8.47	160.5 6.32	3.0 0.12
150 6	168.3 6.625	217.4 8.56	163.6 6.44	3.0 0.12
200 8	219.1 8.625	274.6 10.81	214.4 8.44	3.0 0.12
250 10	273.0 10.750	335.0 13.19	266.7 10.50	3.0 0.12
300 12	323.9 12.750	404.9 15.94	317.5 12.50	3.0 0.12

For information on other alternative sizes, contact Tyco Technical Services

Plate material: stainless steel ASTM A666 Type 304-2B





















See Flange Drilling Specifications on page 96.



G-FIRE GROOVED  
FITTINGS

## Grooved Fittings Pictorial Table of Contents

Grooved  
Fittings

	<b>Figure 510S</b> Short Pattern 90° Cast Elbows Page – 30		<b>Figures 221 &amp; 321</b> Reducing Tees Pages – 36 - 38
	<b>Figure 510</b> 90° Cast Elbows Page – 30		<b>Figure 323</b> Groove x Groove x Male Thread Reducing Tees Pages – 39
	<b>Figure 510DE</b> 90° Drain Elbows Page – 31		<b>Figures 391, 392, &amp; 393</b> Adaptor Nipples Page – 40
	<b>Figure 501</b> 45° Cast Elbows Page – 31		<b>Figure 372</b> Reducers, Small End Threaded (Male) Page – 41
	<b>Figures 212 &amp; 312</b> 22 <sup>1</sup> / <sub>2</sub> ° Elbows Page – 32		<b>Figures 250 &amp; 350</b> Concentric Reducers Pages – 42 - 43
	<b>Figures 211 &amp; 311</b> 1 <sup>1</sup> / <sub>4</sub> ° Elbows Page – 32		<b>Figures 227 Cast &amp; 327 Fabricated</b> Crosses Page – 44
	<b>Figure 519S</b> Short Pattern Tee Page – 33		<b>Figure 750</b> Adacap Page – 45
	<b>Figure 519</b> Tees Page – 33		<b>Figures 260 &amp; 360</b> End Caps Page – 46
	<b>Figure 320</b> Groove x Groove x Male Thread Reducing Tees Page – 34		<b>Figure 343 &amp; 344</b> Flange Adaptors (PN16, PN10 & JIS) Page – 47
	<b>Figure 508</b> Standpipe Tees Page – 35		<b>Figure 341 &amp; 343</b> Flange Adaptors (ANSI & Table E) Page – 48
	<b>Figures 507/50L</b> Bullhead Tees Pages – 35		

## Fittings Specifications

Tech Data Sheet: TFP1815

**10**  
YEAR  
LIMITED  
WARRANTY



For Fire Protection Pressure Rating and Listing / Approval information contact Tyco Fire Protection Products.

GRINNELL ductile iron and fabricated steel Grooved Fittings provide an economical and efficient method of changing direction, adding an outlet, and reducing or capping piping systems.

GRINNELL Grooved Fittings are rated at the pressure rating of the coupling in use.

Grooved Fittings

### MATERIAL SPECIFICATIONS

#### Ductile Iron Fitting Specifications

- ASTM A 536 - Standard specification for ductile iron castings, Grade 65-45-12
- Tensile Strength, minimum 448,159 kPa (65,000 psi)
- Yield Strength, minimum 310,264 kPa (45,000 psi)
- Elongation in 50mm (2"), minimum 12%
- ASTM A 153 – Standard specification for hot-dip galvanising

#### Fabricated Steel Fitting Specifications

- Carbon Steel: According to ASTM A 53, Grade B
- Tensile Strength, minimum 413,685 kPa (60,000 psi)
- Yield Strength, minimum 241,316 kPa (35,000 psi)
- Sizes 32mm – 250mm (1¼" – 10") Schedule 40
- Sizes 300mm (12") STD (.375)

#### Coatings

- Red – Non-lead paint (standard)
- Orange – Non-lead paint (standard)
- Hot-Dipped, Zinc Galvanised (Optional)

#### Threads

- BSP
- NPT

### Fitting Friction Resistance Chart

Pipe Size		Elbows 90° m Feet	Elbows 45° m Feet	Tee Branch m Feet	Tee Run m Feet
Nominal mm Inches	O.D. mm Inches				
25 1	33.4 1.315	0.5 1.6	0.2 0.7	1.3 4.3	0.5 1.6
32 1-¼	42.4 1.660	0.6 1.9	0.3 1.0	1.5 4.8	0.6 1.9
40 1-½	48.3 1.900	0.7 2.3	0.4 1.2	1.8 5.8	0.7 2.3
50 2	60.3 2.375	1.0 3.2	0.5 1.6	2.5 8.0	1.0 3.2
65 2-½	73.0 2.875	1.2 3.9	0.6 2.0	3.0 9.8	1.2 3.9
65 76.1mm	76.1 3.000	1.2 4.1	0.6 2.1	3.1 10.3	1.2 4.1
80 3	88.9 3.500	1.5 4.9	0.7 2.4	3.7 12.2	1.5 4.9
100 4	114.3 4.500	2.0 6.5	1.0 3.3	5.0 16.3	2.0 6.5
125 139.7mm	139.7 5.500	2.4 8.0	1.3 4.1	6.1 20.0	2.4 8.0
125 5	141.3 5.563	2.5 8.2	1.3 4.1	6.3 20.5	2.5 8.2
150 165.1mm	165.1 6.500	2.9 9.5	1.4 4.8	7.2 23.8	2.9 9.5
150 6	168.3 6.625	3.0 9.9	1.5 5.0	7.6 24.8	3.0 9.9
200 8	219.1 8.625	4.0 13.1	2.0 6.6	10.0 32.8	4.0 13.1
250 10	273.0 10.750	5.0 16.5	2.5 8.3	12.6 41.3	5.0 16.5
300 12	323.9 12.750	6.1 19.9	3.0 9.9	15.1 49.7	6.1 19.9

For reducing tee branches, use value corresponding to the branch size. For example, for a 200 x 200 x 50mm (8" x 8" x 2") tee, use a branch value of 50mm (2") is 2.5m (8.0'). For sizes not listed, interpolate from the values shown. Expressed as Equivalent Straight Pipe.

## Figure 510S Short Pattern 90° Cast Elbows

Tech Data Sheet: TFP1815

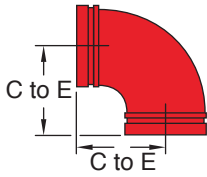

Grooved Fittings

Pipe Size		C to E mm Inches	Approx. Weight kg Lbs.
Nominal mm Inches	O.D. mm Inches		
50	60.3	69.9	0.7
2	2.375	2.75	1.5
65	73.0	76.2	1.0
2½	2.875	3.00	2.1
65	76.1	76.2	1.0
76.1mm	3.000	3.00	2.3
80	88.9	85.9	1.3
3	3.500	3.38	3.0
100	114.3	101.6	2.3
4	4.500	4.00	5.0
125	139.7	124.0	3.9
139.7mm	5.500	4.88	8.6
125	141.3	124.0	3.9
5	5.563	4.88	8.8
150	165.1	139.7	5.0
165.1mm	6.500	5.50	11.0
150	168.3	139.7	5.1
6	6.625	5.50	11.2
200	219.1	174.8	10.6
8	8.625	6.88	23.4

► Sizes are available to JIS standards. Contact GRINNELL Products for details.  
 For information on larger sizes, Chinese sizes or other alternative sizes, contact GRINNELL Products.  
 See fitting specifications on page 29.

## Figure 510 90° Cast Elbows

Tech Data Sheet: TFP1815

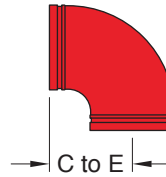

Pipe Size		C to E mm Inches	Approx. Weight kg Lbs.
Nominal mm Inches	O.D. mm Inches		
25	33.4	◆	0.3
1	1.315	◆	0.7
32	42.4	69.9	0.5
1¼	1.660	2.75	1.0
40	48.3	69.9	0.6
1½	1.900	2.75	1.3
50	60.3	82.6	0.8
2	2.375	3.25	1.8
65	73.0	95.3	1.4
2½	2.875	3.75	3.1
65	76.1	95.3	1.5
76.1mm	3.000	3.75	3.2
80	88.9	108.0	2.2
3	3.500	4.25	4.8
100	114.3	127.0	3.4
4	4.500	5.00	7.5
125	139.7	139.7	5.1
139.7mm	5.500	5.50	11.3
125	141.3	139.7	5.3
5	5.563	5.50	11.6
150	165.1	165.1	7.7
165.1mm	6.500	6.50	16.9
150	168.3	165.1	7.5
6	6.625	6.50	16.6
200	216.3	◆	◆
216.3mm	8.500	◆	◆
200	219.1	196.9	13.4
8	8.625	7.75	29.6
250	273.0	228.6	22.0
10	10.750	9.00	48.5
300	323.9	254.0	30.1
12	12.750	10.00	66.4

◆ Contact GRINNELL for dimension details.  
 ► Sizes are available to JIS standards. Contact GRINNELL Products for details.  
 For information on larger sizes, Chinese sizes or other alternative sizes, contact GRINNELL Products.  
 See fitting specifications on page 29.

## Figure 510DE 90° Drain Elbows with 25mm Outlet

Tech Data Sheet: TFP1815

**10**  
YEAR  
LIMITED  
WARRANTY

Pipe Size		C to E mm Inches	A mm Inches	B mm Inches	Approx Weight Kg Lbs.
Nominal mm Inches	O.D. mm Inches				
<b>50</b>	<b>60.3</b>	<b>95.3</b>	<b>50.8</b>	<b>69.9</b>	<b>1.4</b>
2	2.375	3.75	2.00	2.75	3.1
<b>65</b>	<b>73.0</b>	<b>95.3</b>	<b>50.8</b>	<b>69.9</b>	<b>1.0</b>
2½	2.875	3.75	2.00	2.75	2.2
<b>80</b>	<b>88.9</b>	<b>108.0</b>	<b>59.4</b>	<b>69.9</b>	<b>2.7</b>
3	3.500	4.25	2.34	2.75	6.0
<b>100</b>	<b>114.3</b>	<b>127.0</b>	<b>72.4</b>	<b>69.9</b>	<b>3.9</b>
4	4.500	5.00	2.85	2.75	8.6
<b>125</b>	<b>141.3</b>	<b>139.7</b>	<b>85.9</b>	<b>69.9</b>	<b>5.9</b>
5	5.563	5.50	3.38	2.75	13.0
<b>150</b>	<b>168.3</b>	<b>165.1</b>	<b>99.6</b>	<b>69.9</b>	<b>8.2</b>
6	6.625	6.50	3.92	2.75	18.0
<b>200</b> ▶	<b>219.1</b>	<b>196.9</b>	<b>125.7</b>	<b>69.9</b>	<b>14.0</b>
8	8.625	7.75	4.95	2.75	31.0

▶ Sizes are available to JIS standards. Contact GRINNELL Products for details. For information on larger sizes, Chinese sizes or other alternative sizes, contact GRINNELL Products. See fitting specifications on page 29.

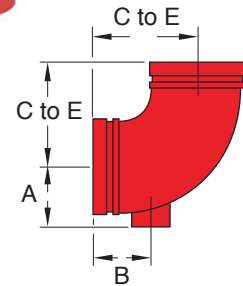

Grooved  
Fittings

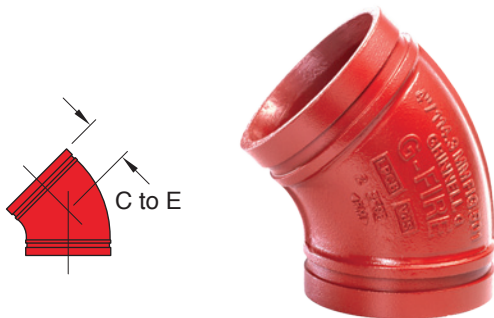

## Figure 501 45° Cast Elbows

Tech Data Sheet: TFP1815

**10**  
YEAR  
LIMITED  
WARRANTY

Pipe Size		C to E mm Inches	Approx. Weight kg Lbs.
Nominal mm Inches	O.D. mm Inches		
<b>25</b>	<b>33.4</b>	◆	<b>0.3</b>
1	1.315	◆	0.6
<b>32</b>	<b>42.4</b>	<b>44.5</b>	<b>0.4</b>
1¼	1.660	1.75	0.9
<b>40</b>	<b>48.3</b>	<b>44.5</b>	<b>0.4</b>
1½	1.900	1.75	0.9
<b>50</b>	<b>60.3</b>	<b>50.8</b>	<b>0.6</b>
2	2.375	2.00	1.3
<b>65</b>	<b>73.0</b>	<b>57.2</b>	<b>1.0</b>
2½	2.875	2.25	2.1
<b>65</b>	<b>76.1</b>	<b>57.2</b>	<b>1.0</b>
76.1mm	3.000	2.25	2.2
<b>80</b>	<b>88.9</b>	<b>63.5</b>	<b>1.6</b>
3	3.500	2.50	3.5
<b>100</b>	<b>114.3</b>	<b>76.2</b>	<b>2.5</b>
4	4.500	3.00	5.5
<b>125</b>	<b>139.7</b>	<b>82.6</b>	<b>3.5</b>
139.7mm	5.500	3.25	7.7

Pipe Size		C to E mm Inches	Approx. Weight kg Lbs.
Nominal mm Inches	O.D. mm Inches		
<b>125</b>	<b>141.3</b>	<b>82.6</b>	<b>3.7</b>
5	5.563	3.25	8.1
<b>150</b>	<b>165.1</b>	<b>88.9</b>	<b>5.0</b>
165.1mm	6.500	3.50	11.0
<b>150</b>	<b>168.3</b>	<b>88.9</b>	<b>5.1</b>
6	6.625	3.50	11.2
<b>200</b> ▶	<b>216.3</b>	◆	◆
216.3mm	8.500	◆	◆
<b>200</b> ▶	<b>219.1</b>	<b>108.0</b>	<b>8.6</b>
8	8.625	4.25	19.0
<b>250</b> ▶	<b>273.0</b>	<b>120.7</b>	<b>12.7</b>
10	10.750	4.75	28.0
<b>300</b> ▶	<b>323.9</b>	<b>133.4</b>	<b>22.0</b>
12	12.750	5.25	48.0

◆ Contact GRINNELL for dimension details.  
▶ Sizes are available to JIS standards. Contact GRINNELL Products for details.  
For information on larger sizes, Chinese sizes or other alternative sizes, contact GRINNELL Products.  
See fitting specifications on page 29.

## Figures 212 & 312 22-1/2° Elbows

Tech Data Sheet: TFP1815

**10**  
YEAR  
LIMITED  
WARRANTY

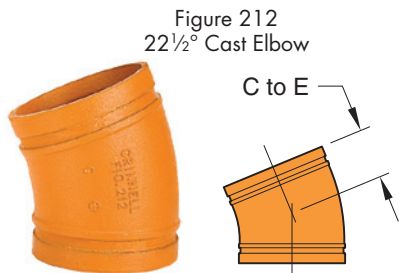
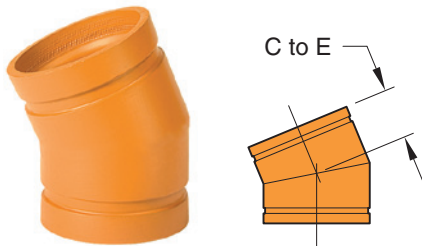

Figure 312  
22 1/2° Fabricated Elbow



Grooved  
Fittings

Pipe Size		Figure 212 Cast		Figure 312 Fabricated	
Nominal mm Inches	O.D. mm Inches	C to E mm Inches	Approx. Weight kg Lbs.	C to E mm Inches	Approx. Weight kg Lbs.
25 1	33.4 1.315	-	-	◆ ◆	◆ ◆
32 1-1/4	42.4 1.660	44.5 1.75	0.4 0.8	-	-
40 1-1/2	48.3 1.900	44.5 1.75	0.5 1.0	-	-
50 2	60.3 2.375	47.8 1.88	0.6 1.3	-	-
65 2-1/2	73.0 2.875	50.8 2.00	0.9 1.9	-	-
65 76.1mm	76.1 3.000	50.8 2.00	0.9 1.9	-	-
80 3	88.9 3.500	57.2 2.25	1.3 2.9	-	-
100 4	114.3 4.500	66.8 2.63	2.1 4.7	-	-
125 139.7mm	139.7 5.500	73.2 2.88	3.1 6.9	-	-
125 5	141.3 5.563	73.2 2.88	3.1 6.9	-	-
150 165.1mm	165.1 6.500	79.5 3.13	4.3 9.4	-	-
150 6	168.3 6.625	79.5 3.13	4.3 9.4	-	-
200 8	219.1 8.625	98.6 3.88	7.7 16.9	-	-
250 10	273.0 10.750	-	-	111.3 4.38	6.4 14.0
300 12	323.9 12.750	-	-	124.0 4.88	10.0 22.0

◆ Contact GRINNELL for dimension details.  
For information on larger sizes, Chinese sizes or other alternative sizes, contact GRINNELL Products.  
See fitting specifications on page 29.

## Figures 211 & 311 11-1/4° Elbows

Tech Data Sheet: TFP1815

**10**  
YEAR  
LIMITED  
WARRANTY

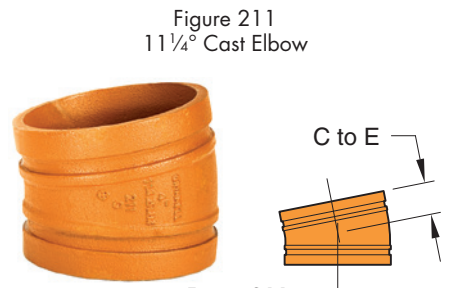
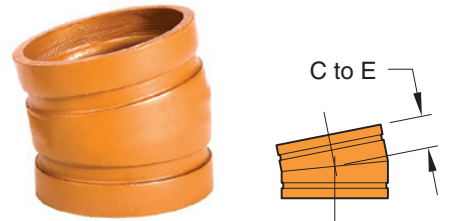

Figure 311  
11 1/4° Fabricated Elbow



Pipe Size		Figure 211 Cast		Figure 311 Fabricated	
Nominal mm Inches	O.D. mm Inches	C to E mm Inches	Approx. Weight kg Lbs.	C to E mm Inches	Approx. Weight kg Lbs.
25 1	33.4 1.315	-	-	◆ ◆	◆ ◆
32 1-1/4	42.4 1.660	35.1 1.38	0.3 0.7	-	-
40 1-1/2	48.3 1.900	35.1 1.38	0.4 0.8	-	-
50 2	60.3 2.375	35.1 1.38	0.5 1.1	-	-
65 2-1/2	73.0 2.875	38.1 1.50	0.7 1.6	-	-
65 76.1mm	76.1 3.000	38.1 1.50	0.7 1.7	-	-
80 3	88.9 3.500	38.1 1.50	1.0 2.2	-	-
100 4	114.3 4.500	44.5 1.75	1.5 3.4	-	-
125 139.7mm	139.7 5.500	50.8 2.00	2.3 5.1	-	-
125 5	141.3 5.563	50.8 2.00	2.4 5.2	-	-
150 165.1mm	165.1 6.500	50.8 2.00	2.9 6.4	-	-
150 6	168.3 6.625	50.8 2.00	2.9 6.5	-	-
200 8	219.1 8.625	50.8 2.00	4.2 9.2	-	-
250 10	273.0 10.750	-	-	54.1 2.13	4.1 9.1
300 12	323.9 12.750	-	-	57.2 2.25	7.6 16.7

◆ Contact GRINNELL for dimension details.  
For information on larger sizes, Chinese sizes or other alternative sizes, contact GRINNELL Products.  
See fitting specifications on page 29.



## Figure 519S Short Pattern Tees

Tech Data Sheet: TFP1815

**10**  
YEAR  
LIMITED  
WARRANTY

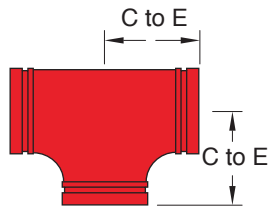

Pipe Size		C to E mm Inches	Approx Weight Kg Lbs.
Nominal mm Inches	O.D. mm Inches		
50	60.3	69.9	1.0
2	2.375	2.75	2.1
65	73.0	76.2	1.4
2-1/2	2.875	3.00	3.1
65	76.1	76.2	1.4
76.1mm	3.000	3.00	3.1
80	88.9	85.9	1.9
3	3.500	3.38	4.1
100	114.3	101.6	3.0
4	4.500	4.00	6.7
125	139.7	124.0	5.0
139.7mm	5.500	4.88	11.0
125	141.3	124.0	5.0
5	5.563	4.88	11.0
150	165.1	139.7	6.8
165.1mm	6.500	5.50	14.9
150	168.3	139.7	6.8
6	6.625	5.50	15.0
200	219.1	174.8	11.8
8	8.625	6.88	26.1

► Sizes are available to JIS standards. Contact GRINNELL Products for details.  
For information on larger sizes, Chinese sizes or other alternative sizes, contact GRINNELL Products.  
See fitting specifications on page 29.

## Figures 519 Tees

Tech Data Sheet: TFP1815

**10**  
YEAR  
LIMITED  
WARRANTY

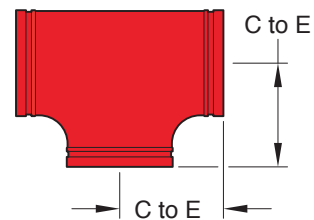

Pipe Size		C to E mm Inches	Approx Weight Kg Lbs.
Nominal mm Inches	O.D. mm Inches		
25	33.4	◆	0.5
1	1.315	◆	1.1
32	42.4	69.9	0.8
1-1/4	1.660	2.75	1.7
40	48.3	69.9	0.9
1-1/2	1.900	2.75	1.9
50	60.3	82.6	1.3
2	2.375	3.25	2.8
65	73.0	95.3	2.0
2-1/2	2.875	3.75	4.5
65	76.1	95.3	2.0
76.1mm	3.000	3.75	4.5
80	88.9	108.0	2.7
3	3.500	4.25	5.9
100	114.3	127.0	4.3
4	4.500	5.00	9.5
125	139.7	139.7	6.3
139.7mm	5.500	5.50	13.9
125	141.3	139.7	6.3
5	5.563	5.50	13.9
150	165.1	165.1	8.9
165.1mm	6.500	6.50	19.7
150	168.3	165.1	9.3
6	6.625	6.50	20.4
200	216.3	196.9	19.5
216.3mm	8.500	7.75	43.0
200	219.1	196.9	14.1
8	8.625	7.75	31.0
250	273.0	228.6	25.9
10	10.750	9.00	57.0
300	323.9	254.0	49.9
12	12.750	10.00	110.0

◆ Contact GRINNELL for dimension details.  
► Sizes are available to JIS standards. Contact GRINNELL Products for details.  
For information on larger sizes, Chinese sizes or other alternative sizes, contact GRINNELL Products.  
See fitting specifications on page 29.

Grooved  
Fittings

## Figure 320 Groove x Groove x Male Thread Tees

Tech Data Sheet: TFP1815



Grooved  
Fittings

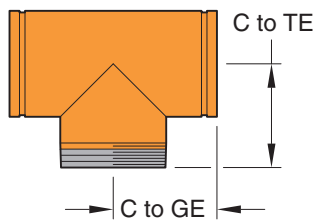

Pipe Size		C to GE mm Inches	C to TE mm Inches	Approx. Weight kg Lbs.
Nominal mm Inches	O.D. mm Inches			
25	33.4	◆	◆	◆
1	1.315	◆	◆	◆
32	42.4	69.9	69.9	0.7
1-1/4	1.660	2.75	2.75	1.5
40	48.3	69.9	69.9	0.9
1-1/2	1.900	2.75	2.75	1.9
50	60.3	82.6	108.0	1.5
2	2.375	3.25	4.25	3.2
65	73.0	95.3	95.3	1.8
2-1/2	2.875	3.75	3.75	4.0
65	76.1	95.3	95.3	1.8
76.1mm	3.000	3.75	3.75	4.0
80	88.9	108.0	152.4	2.7
3	3.500	4.25	6.00	6.0
100	114.3	127.0	184.2	5.0
4	4.500	5.00	7.25	11.0
125	139.7	139.7	139.7	10.5
139.7mm	5.500	5.50	5.50	23.0
125	141.3	139.7	139.7	10.5
5	5.563	5.50	5.50	23.0
150	165.1	165.1	165.1	10.5
165.1mm	6.500	6.50	6.50	23.0
150	168.3	165.1	165.1	10.5
6	6.625	6.50	6.50	23.0
200	219.1	196.9	196.9	17.6
8	8.625	7.75	7.75	38.7
250	273.0	228.6	228.6	32.8
10	10.750	9.00	9.00	72.1
300	323.9	254.0	254.0	42.0
12	12.750	10.00	10.00	92.5

◆ Contact GRINNELL for dimension details.

For information on larger sizes, Chinese sizes or other alternative sizes, contact GRINNELL Products.

Available with BSP or NPT threads. Contact GRINNELL Products for details.

See fitting specifications on page 29.

## Figure 508 Standpipe Tees

Tech Data Sheet: TFP1815



Pipe Size		C to GE mm Inches	C to TE mm Inches	Approx. Weight kg Lbs.
Nominal mm Inches	O.D. mm Inches			
<b>100 x 100 x 65</b>	<b>114.3 x 114.3 x 73.0mm</b>	◆	◆	◆
4 x 4 x 2-1/2	4.500 x 4.500 x 2.875	◆	◆	◆
<b>150 x 150 x 65</b>	<b>168.3 x 168.3 x 73.0mm</b>	◆	◆	◆
6 x 6 x 2-1/2	6.625 x 6.625 x 2.875	◆	◆	◆

◆ Contact GRINNELL for dimension details.  
 For information on larger sizes, Chinese sizes or other alternative sizes, contact GRINNELL Products.  
 Available with BSP threads. Contact GRINNELL Products for details.  
 See fitting specifications on page 29.

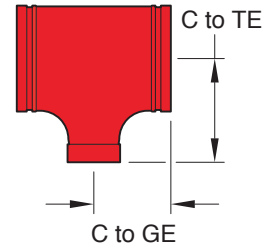

Grooved  
Fittings

## Figures 507/50L Bullhead Tees

Tech Data Sheet: TFP1815



Pipe Size		C to GE mm Inches	C to TE mm Inches	Approx. Weight kg Lbs.
Nominal mm Inches	O.D. mm Inches			
<b>125 x 125 x 200</b>	<b>141.3 x 141.3 x 219.1mm</b>	◆	◆	◆
5 x 5 x 8	5.563 x 5.563 x 8.625	◆	◆	◆
<b>150 x 150 x 200</b>	<b>168.3 x 168.3 x 219.1mm</b>	◆	◆	◆
6 x 6 x 8	6.625 x 6.625 x 8.625	◆	◆	◆

◆ Contact GRINNELL for dimension details.  
 For information on larger sizes, Chinese sizes or other alternative sizes, contact GRINNELL Products.  
 Available with BSP threads. Contact GRINNELL Products for details.  
 See fitting specifications on page 29.

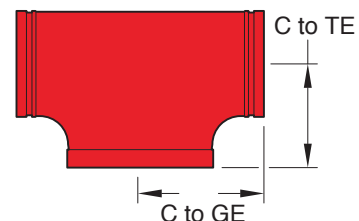

## Figures 221 & 321 Reducing Tees

(Page 1 of 3)

Tech Data Sheet: TFP1815

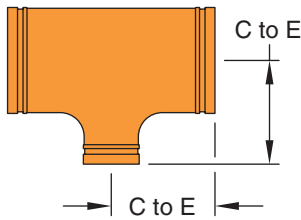

Figure 221 Reducing Tee Cast

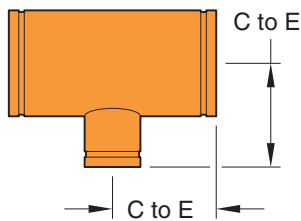

Figure 321 Reducing Tee Fabricated

Pipe Size		Figure 221 Cast		Figure 321 Fabricated	
Nominal mm Inches	O.D. mm Inches	C to E mm Inches	Approx. Weight kg Lbs.	C to E mm Inches	Approx. Weight kg Lbs.
25 x 25 x 20 1 x 1 x 3/4	33.4 x 33.4 x 26.7 1.315 x 1.315 x 1.050	-	-	◆	◆
32 x 32 x 25 1-1/4 x 1-1/4 x 1	42.4 x 42.4 x 33.4 1.660 x 1.660 x 1.315	-	-	◆	◆
40 x 40 x 20 1-1/2 x 1-1/2 x 3/4	48.3 x 48.3 x 26.7 1.900 x 1.900 x 1.050	-	-	◆	◆
40 x 40 x 25 1-1/2 x 1-1/2 x 1	48.3 x 48.3 x 33.4 1.900 x 1.900 x 1.315	-	-	◆	◆
40 x 40 x 32 1-1/2 x 1-1/2 x 1-1/4	48.3 x 48.3 x 42.4 1.900 x 1.900 x 1.660	-	-	69.9 2.75	0.7 1.5
50 x 50 x 20 2 x 2 x 3/4	60.3 x 60.3 x 26.7 2.375 x 2.375 x 1.050	-	-	◆	◆
50 x 50 x 25 2 x 2 x 1	60.3 x 60.3 x 33.4 2.375 x 2.375 x 1.315	-	-	88.6 3.25	0.74 1.6
50 x 50 x 32 2 x 2 x 1-1/4	60.3 x 60.3 x 42.4 2.375 x 2.375 x 1.660	-	-	◆	◆
50 x 50 x 40 2 x 2 x 1-1/2	60.3 x 60.3 x 48.3 2.375 x 2.375 x 1.900	82.6 3.25	1.2 2.7	-	-
65 x 65 x 20 2-1/2 x 2-1/2 x 3/4	73.0 x 73.0 x 26.7 2.875 x 2.875 x 1.050	-	-	◆	◆
65 x 65 x 25 2-1/2 x 2-1/2 x 1	73.0 x 73.0 x 33.4 2.875 x 2.875 x 1.315	-	-	95.3 3.75	1.1 2.3
65 x 65 x 32 2-1/2 x 2-1/2 x 1-1/4	73.0 x 73.0 x 42.4 2.875 x 2.875 x 1.660	-	-	95.3 3.75	1.9 4.2
65 x 65 x 40 2-1/2 x 2-1/2 x 1-1/2	73.0 x 73.0 x 48.3 2.875 x 2.875 x 1.900	-	-	95.3 3.75	1.9 4.2
65 x 65 x 50 2-1/2 x 2-1/2 x 2	73.0 x 73.0 x 60.3 2.875 x 2.875 x 2.375	95.3 3.75	1.9 4.2	-	-
65 x 65 x 40 76.1 x 76.1mm x 1-1/2	76.1 x 76.1 x 48.3 3.000 x 3.000 x 1.900	95.3 3.75	2.0 4.5	-	-
65 x 65 x 50 76.1 x 76.1mm x 2	76.1 x 76.1 x 60.3 3.000 x 3.000 x 2.375	95.3 3.75	2.0 4.3	-	-
80 x 80 x 20 3 x 3 x 3/4	88.9 x 88.9 x 26.7 3.500 x 3.500 x 1.050	-	-	◆	◆
80 x 80 x 25 3 x 3 x 1	88.9 x 88.9 x 33.4 3.500 x 3.500 x 1.315	108.0 4.25	2.5 5.6	-	-
80 x 80 x 32 3 x 3 x 1-1/4	88.9 x 88.9 x 42.4 3.500 x 3.500 x 1.660	-	-	◆	◆
80 x 80 x 40 3 x 3 x 1-1/2	88.9 x 88.9 x 48.3 3.500 x 3.500 x 1.900	108.0 4.25	2.7 5.9	-	-
80 x 80 x 50 3 x 3 x 2	88.9 x 88.9 x 60.3 3.500 x 3.500 x 2.375	108.0 4.25	2.7 6.0	-	-
80 x 80 x 65 3 x 3 x 2-1/2	88.9 x 88.9 x 73.0 3.500 x 3.500 x 2.875	108.0 4.25	2.8 6.2	-	-
80 x 80 x 65 3 x 3 x 76.1mm	88.9 x 88.9 x 76.1 3.500 x 3.500 x 3.000	108.0 4.25	2.7 6.0	-	-
100 x 100 x 20 4 x 4 x 3/4	114.3 x 114.3 x 26.7 4.500 x 4.500 x 1.050	-	-	◆	◆
100 x 100 x 25 4 x 4 x 1	114.3 x 114.3 x 33.4 4.500 x 4.500 x 1.315	-	-	95.3 3.75	3.7 8.0
100 x 100 x 32 4 x 4 x 1-1/4	114.3 x 114.3 x 42.4 4.500 x 4.500 x 1.660	-	-	127.0 5.00	4.4 9.8
100 x 100 x 40 4 x 4 x 1-1/2	114.3 x 114.3 x 48.3 4.500 x 4.500 x 1.900	-	-	127.0 5.00	4.5 9.9
100 x 100 x 50 4 x 4 x 2	114.3 x 114.3 x 60.3 4.500 x 4.500 x 2.375	127.0 5.00	4.1 9.1	-	-

## Figures 221 & 321 Reducing Tees

(Page 2 of 3)

Tech Data Sheet: TFP1815



Pipe Size		Figure 221 Cast		Figure 321 Fabricated	
Nominal mm Inches	O.D. mm Inches	C to E mm Inches	Approx. Weight kg Lbs.	C to E mm Inches	Approx. Weight kg Lbs.
<b>100 x 100 x 65</b>	<b>114.3 x 114.3 x 73.0</b>	<b>127.0</b>	<b>4.3</b>	–	–
4 x 4 x 2-1/2	4.500 x 4.500 x 2.875	5.00	9.5	–	–
<b>100 x 100 x 65</b>	<b>114.3 x 114.3 x 76.1</b>	<b>127.0</b>	<b>4.3</b>	–	–
4 x 4 x 76.1mm	4.500 x 4.500 x 3.000	5.00	9.5	–	–
<b>100 x 100 x 80</b>	<b>114.3 x 114.3 x 88.9</b>	<b>127.0</b>	<b>4.4</b>	–	–
4 x 4 x 3	4.500 x 4.500 x 3.500	5.00	9.7	–	–
<b>125 x 125 x 80</b>	<b>139.7 x 139.7 x 88.9</b>	<b>139.7</b>	<b>5.8</b>	–	–
139.7 x 139.7mm x 3	5.500 x 5.500 x 3.500	5.50	12.7	–	–
<b>125 x 125 x 100</b>	<b>139.7 x 139.7 x 114.3</b>	<b>139.7</b>	<b>6.1</b>	–	–
139.7 x 139.7mm x 4	5.500 x 5.500 x 4.500	5.50	13.4	–	–
<b>125 x 125 x 25</b>	<b>141.3 x 141.3 x 33.4</b>	–	–	◆	◆
5 x 5 x 1	5.563 x 5.563 x 1.315	–	–	◆	◆
<b>125 x 125 x 40</b>	<b>141.3 x 141.3 x 48.3</b>	–	–	◆	◆
5 x 5 x 1-1/2	5.563 x 5.563 x 1.900	–	–	◆	◆
<b>125 x 125 x 50</b>	<b>141.3 x 141.3 x 60.3</b>	–	–	<b>139.7</b>	<b>6.6</b>
5 x 5 x 2	5.563 x 5.563 x 2.375	–	–	5.50	14.5
<b>125 x 125 x 65</b>	<b>141.3 x 141.3 x 73.0</b>	<b>139.7</b>	<b>8.2</b>	–	–
5 x 5 x 2-1/2	5.563 x 5.563 x 2.875	5.50	18.0	–	–
<b>125 x 125 x 80</b>	<b>141.3 x 141.3 x 88.9</b>	<b>139.7</b>	<b>6.4</b>	–	–
5 x 5 x 3	5.563 x 5.563 x 3.500	5.50	14.0	–	–
<b>125 x 125 x 100</b>	<b>141.3 x 141.3 x 114.3</b>	<b>139.7</b>	<b>6.3</b>	–	–
5 x 5 x 4	5.563 x 5.563 x 4.500	5.50	13.9	–	–
<b>150 x 150 x 80</b>	<b>165.1 x 165.1 x 88.9</b>	<b>165.1</b>	<b>8.2</b>	–	–
165.1 x 165.1mm x 3	6.500 x 6.500 x 3.500	6.50	18.0	–	–
<b>150 x 150 x 100</b>	<b>165.1 x 165.1 x 114.3</b>	<b>165.1</b>	<b>8.9</b>	–	–
165.1 x 165.1mm x 4	6.500 x 6.500 x 4.500	6.50	19.5	–	–
<b>150 x 150 x 25</b>	<b>168.3 x 168.3 x 33.4</b>	–	–	◆	◆
6 x 6 x 1	6.625 x 6.625 x 1.315	–	–	◆	◆
<b>150 x 150 x 40</b>	<b>168.3 x 168.3 x 48.3</b>	–	–	◆	◆
6 x 6 x 1-1/2	6.625 x 6.625 x 1.900	–	–	◆	◆
<b>150 x 150 x 50</b>	<b>168.3 x 168.3 x 60.3</b>	<b>165.1</b>	<b>8.8</b>	–	–
6 x 6 x 2	6.625 x 6.625 x 2.375	6.50	19.4	–	–
<b>150 x 150 x 65</b>	<b>168.3 x 168.3 x 73.0</b>	<b>165.1</b>	<b>9.8</b>	–	–
6 x 6 x 2-1/2	6.625 x 6.625 x 2.875	6.50	21.2	–	–
<b>150 x 150 x 65</b>	<b>168.3 x 168.3 x 76.1</b>	<b>165.1</b>	<b>9.8</b>	–	–
6 x 6 x 76.1mm	6.625 x 6.625 x 3.000	6.50	21.2	–	–
<b>150 x 150 x 80</b>	<b>168.3 x 168.3 x 88.9</b>	<b>165.1</b>	<b>9.5</b>	–	–
6 x 6 x 3	6.625 x 6.625 x 3.500	6.50	21.0	–	–
<b>150 x 150 x 100</b>	<b>168.3 x 168.3 x 114.3</b>	<b>165.1</b>	<b>9.9</b>	–	–
6 x 6 x 4	6.625 x 6.625 x 4.500	6.50	21.8	–	–
<b>150 x 150 x 125</b>	<b>168.3 x 168.3 x 139.7</b>	–	–	<b>165.1</b>	<b>10.4</b>
6 x 6 x 139.7mm	6.625 x 6.625 x 5.500	–	–	6.50	23.0
<b>150 x 150 x 125</b>	<b>168.3 x 168.3 x 141.3</b>	–	–	<b>165.1</b>	<b>12.2</b>
6 x 6 x 5	6.625 x 6.625 x 5.563	–	–	6.50	27.0
<b>200 x 200 x 40</b> ▶	<b>219.1 x 219.1 x 48.3</b>	–	–	◆	◆
8 x 8 x 1-1/2	8.625 x 8.625 x 1.900	–	–	◆	◆
<b>200 x 200 x 50</b> ▶	<b>219.1 x 219.1 x 60.3</b>	–	–	<b>196.9</b>	<b>16.4</b>
8 x 8 x 2	8.625 x 8.625 x 2.375	–	–	7.75	36.2
<b>200 x 200 x 65</b> ▶	<b>219.1 x 219.1 x 73.0</b>	–	–	<b>196.9</b>	<b>16.5</b>
8 x 8 x 2-1/2	8.625 x 8.625 x 2.875	–	–	7.75	36.4
<b>200 x 200 x 80</b> ▶	<b>219.1 x 219.1 x 88.9</b>	–	–	<b>196.9</b>	<b>16.6</b>
8 x 8 x 3	8.625 x 8.625 x 3.500	–	–	7.75	36.5
<b>200 x 200 x 100</b> ▶	<b>219.1 x 219.1 x 114.1</b>	<b>196.9</b>	<b>16.9</b>	–	–
8 x 8 x 4	8.625 x 8.625 x 4.500	7.75	37.2	–	–
<b>200 x 200 x 125</b> ▶	<b>219.1 x 219.1 x 139.7</b>	–	–	<b>196.9</b>	<b>17.1</b>
8 x 8 x 139.7mm	8.625 x 8.625 x 5.500	–	–	7.75	37.7

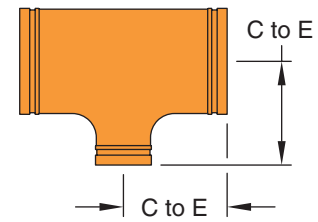

Figure 221 Reducing Tee  
Cast

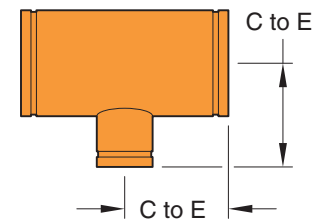

Figure 321 Reducing Tee  
Fabricated

Grooved  
Fittings

## Figures 221 & 321 Reducing Tees

(Page 3 of 3)

Tech Data Sheet: TFP1815

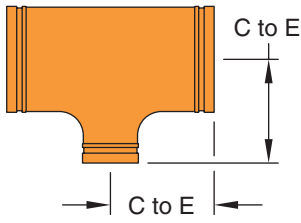

Figure 221 Reducing Tee Cast

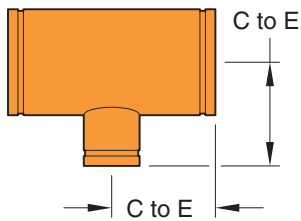

Figure 321 Reducing Tee Fabricated

Pipe Size		Figure 221 Cast		Figure 321 Fabricated	
Nominal mm Inches	O.D. mm Inches	C to E mm Inches	Approx. Weight kg Lbs.	C to E mm Inches	Approx. Weight kg Lbs.
<b>200 x 200 x 125</b> ▶ 8 x 8 x 5	<b>219.1 x 219.1 x 141.3</b> 8.625 x 8.625 x 5.563	–	–	<b>196.9</b> 7.75	<b>16.7</b> 36.8
<b>200 x 200 x 150</b> ▶ 8 x 8 x 165.1mm	<b>219.1 x 219.1 x 165.1</b> 8.625 x 8.625 x 6.500	<b>196.9</b> 7.75	<b>17.1</b> 37.7	–	–
<b>200 x 200 x 150</b> ▶ 8 x 8 x 6	<b>219.1 x 219.1 x 168.3</b> 8.625 x 8.625 x 6.625	<b>196.9</b> 7.75	<b>17.0</b> 37.4	–	–
<b>250 x 250 x 40</b> ▶ 10 x 10 x 1½	<b>273.0 x 273.0 x 48.3</b> 10.750 x 10.750 x 1.900	–	–	♦	♦
<b>250 x 250 x 50</b> ▶ 10 x 10 x 2	<b>273.0 x 273.0 x 60.3</b> 10.750 x 10.750 x 2.375	–	–	<b>228.6</b> 9.00	<b>25.9</b> 57.1
<b>250 x 250 x 65</b> ▶ 10 x 10 x 2½	<b>273.0 x 273.0 x 73.0</b> 10.750 x 10.750 x 2.875	–	–	♦	♦
<b>250 x 250 x 80</b> ▶ 10 x 10 x 3	<b>273.0 x 273.0 x 88.9</b> 10.750 x 10.750 x 3.500	–	–	<b>228.6</b> 9.00	<b>26.0</b> 57.4
<b>250 x 250 x 100</b> ▶ 10 x 10 x 4	<b>273.0 x 273.0 x 114.3</b> 10.750 x 10.750 x 4.500	<b>228.6</b> 9.00	<b>26.3</b> 58.0		
<b>250 x 250 x 125</b> ▶ 10 x 10 x 5	<b>273.0 x 273.0 x 141.3</b> 10.750 x 10.750 x 5.563	–	–	<b>228.6</b> 9.00	<b>26.2</b> 57.8
<b>250 x 250 x 150</b> ▶ 10 x 10 x 6	<b>273.0 x 273.0 x 168.3</b> 10.750 x 10.750 x 6.625	<b>228.6</b> 9.00	<b>27.2</b> 66.0		
<b>250 x 250 x 200</b> ▶ 10 x 10 x 8	<b>273.0 x 273.0 x 219.1</b> 10.750 x 10.750 x 8.625	<b>228.6</b> 9.00	<b>28.1</b> 62.0		
<b>300 x 300 x 25</b> ▶ 12 x 12 x 1	<b>323.9 x 323.9 x 33.4</b> 12.750 x 12.750 x 1.315	–	–	♦	♦
<b>300 x 300 x 50</b> ▶ 12 x 12 x 2	<b>323.9 x 323.9 x 60.3</b> 12.750 x 12.750 x 2.375	–	–	♦	♦
<b>300 x 300 x 65</b> ▶ 12 x 12 x 2½	<b>323.9 x 323.9 x 73.0</b> 12.750 x 12.750 x 2.875	–	–	♦	♦
<b>300 x 300 x 80</b> ▶ 12 x 12 x 3	<b>323.9 x 323.9 x 88.9</b> 12.750 x 12.750 x 3.500	–	–	<b>254.0</b> 10.00	<b>36.4</b> 80.2
<b>300 x 300 x 100</b> ▶ 12 x 12 x 4	<b>323.9 x 323.9 x 114.3</b> 12.750 x 12.750 x 4.500	–	–	<b>254.0</b> 10.00	<b>36.5</b> 80.5
<b>300 x 300 x 125</b> ▶ 12 x 12 x 5	<b>323.9 x 323.9 x 141.3</b> 12.750 x 12.750 x 5.563	–	–	<b>254.0</b> 10.00	<b>36.6</b> 80.7
<b>300 x 300 x 150</b> ▶ 12 x 12 x 6	<b>323.9 x 323.9 x 168.3</b> 12.750 x 12.750 x 6.625	–	–	<b>254.0</b> 10.00	<b>36.7</b> 80.9
<b>300 x 300 x 200</b> ▶ 12 x 12 x 8	<b>323.9 x 323.9 x 219.1</b> 12.750 x 12.750 x 8.625	–	–	<b>254.0</b> 10.00	<b>34.6</b> 76.3
<b>300 x 300 x 250</b> ▶ 12 x 12 x 10	<b>323.9 x 323.9 x 273.0</b> 12.750 x 12.750 x 10.750	–	–	<b>254.0</b> 10.00	<b>35.2</b> 77.6

♦ Contact GRINNELL for dimension details.  
▶ Sizes are available to JIS standards. Contact GRINNELL Products for details.  
For information on larger sizes, contact GRINNELL Products.  
See fitting specifications on page 29.

## Figure 323 Groove x Groove x Male Thread Reducing Tees

Tech Data Sheet: TFP1815

**10**  
YEAR  
LIMITED  
WARRANTY

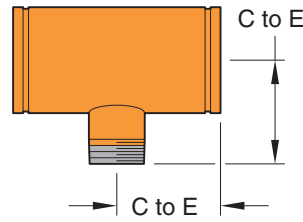

Pipe Size		C to GE & C to TE mm Inches	Approx. Weight kg Lbs.
Nominal mm Inches	O.D. mm Inches		
50 x 50 x 20 2 x 2 x 3/4	60.3 x 60.3 x 26.7 2.375 x 2.375 x 1.050	◆	◆
50 x 50 x 25 2 x 2 x 1	60.3 x 60.3 x 33.4 2.375 x 2.375 x 1.315	82.6 3.25	1.0 2.2
50 x 50 x 32 2 x 2 x 1-1/4	60.3 x 60.3 x 42.4 2.375 x 2.375 x 1.660	82.6 3.25	1.0 2.3
50 x 50 x 40 2 x 2 x 1-1/2	60.3 x 60.3 x 48.3 2.375 x 2.375 x 1.900	82.6 3.25	1.1 1.4
65 x 65 x 20 2-1/2 x 2-1/2 x 3/4	73.0 x 73.0 x 26.7 2.875 x 2.875 x 1.050	◆	◆
65 x 65 x 25 2-1/2 x 2-1/2 x 1	73.0 x 73.0 x 33.4 2.875 x 2.875 x 1.315	95.3 3.75	1.6 3.6
65 x 65 x 32 2-1/2 x 2-1/2 x 1-1/4	73.0 x 73.0 x 42.4 2.875 x 2.875 x 1.660	95.3 3.75	1.7 3.8
65 x 65 x 40 2-1/2 x 2-1/2 x 1-1/2	73.0 x 73.0 x 48.3 2.875 x 2.875 x 1.900	95.3 3.75	1.8 4.0
65 x 65 x 50 2-1/2 x 2-1/2 x 2	73.0 x 73.0 x 60.3 2.875 x 2.875 x 2.375	95.3 3.75	1.9 4.2
80 x 80 x 20 3 x 3 x 3/4	88.9 x 88.9 x 26.7 3.500 x 3.500 x 1.050	◆	◆
80 x 80 x 25 3 x 3 x 1	88.9 x 88.9 x 33.4 3.500 x 3.500 x 1.315	108.0 4.25	2.6 5.7
80 x 80 x 32 3 x 3 x 1-1/4	88.9 x 88.9 x 42.4 3.500 x 3.500 x 1.660	◆	◆
80 x 80 x 40 3 x 3 x 1-1/2	88.9 x 88.9 x 48.3 3.500 x 3.500 x 1.900	108.0 4.25	2.6 5.8
80 x 80 x 50 3 x 3 x 2	88.9 x 88.9 x 60.3 3.500 x 3.500 x 2.375	108.0 4.25	2.7 5.9
80 x 80 x 65 3 x 3 x 2-1/2	88.9 x 88.9 x 73.0 3.500 x 3.500 x 2.875	108.0 4.25	2.9 6.3
100 x 100 x 20 4 x 4 x 3/4	114.3 x 114.3 x 26.7 4.500 x 4.500 x 1.050	◆	◆
100 x 100 x 25 4 x 4 x 1	114.3 x 114.3 x 33.4 4.500 x 4.500 x 1.315	95.3 3.75	3.1 6.9
100 x 100 x 32 4 x 4 x 1-1/4	114.3 x 114.3 x 42.4 4.500 x 4.500 x 1.660	95.3 3.75	3.4 7.6
100 x 100 x 40 4 x 4 x 1-1/2	114.3 x 114.3 x 48.3 4.500 x 4.500 x 1.900	127.0 5.00	3.8 8.3
100 x 100 x 50 4 x 4 x 2	114.3 x 114.3 x 60.3 4.500 x 4.500 x 2.375	127.0 5.00	4.4 9.6
100 x 100 x 65 4 x 4 x 2-1/2	114.3 x 114.3 x 73.0 4.500 x 4.500 x 2.875	127.0 5.00	4.5 10.0
100 x 100 x 80 4 x 4 x 3	114.3 x 114.3 x 88.9 4.500 x 4.500 x 3.500	127.0 5.00	4.7 10.3
125 x 125 x 50 5 x 5 x 2	141.3 x 141.3 x 60.3 5.563 x 5.563 x 2.375	139.7 5.50	6.4 14.0
125 x 125 x 65 5 x 5 x 2-1/2	141.3 x 141.3 x 73.0 5.563 x 5.563 x 2.875	139.7 5.50	6.5 14.3
125 x 125 x 80 5 x 5 x 3	141.3 x 141.3 x 88.9 5.563 x 5.563 x 3.500	139.7 5.50	6.6 14.6
125 x 125 x 100 5 x 5 x 4	141.3 x 141.3 x 114.3 5.563 x 5.563 x 4.500	139.7 5.50	6.8 15.1

Pipe Size		C to GE & C to TE mm Inches	Approx. Weight kg Lbs.
Nominal mm Inches	O.D. mm Inches		
150 x 150 x 25 6 x 6 x 1	168.3 x 168.3 x 33.4 6.625 x 6.625 x 1.315	◆	◆
150 x 150 x 40 6 x 6 x 1-1/2	168.3 x 168.3 x 48.3 6.625 x 6.625 x 1.900	◆	◆
150 x 150 x 50 6 x 6 x 2	168.3 x 168.3 x 60.3 6.625 x 6.625 x 2.375	165.1 6.50	9.7 21.3
150 x 150 x 65 6 x 6 x 2-1/2	168.3 x 168.3 x 73.0 6.625 x 6.625 x 2.875	165.1 6.50	9.8 21.7
150 x 150 x 80 6 x 6 x 3	168.3 x 168.3 x 88.9 6.625 x 6.625 x 3.500	165.1 6.50	10.0 22.0
150 x 150 x 100 6 x 6 x 4	168.3 x 168.3 x 114.3 6.625 x 6.625 x 4.500	165.1 6.50	10.2 22.5
150 x 150 x 125 6 x 6 x 5	168.3 x 168.3 x 141.3 6.625 x 6.625 x 5.563	165.1 6.50	10.5 23.1
200 x 200 x 50 8 x 8 x 2	219.1 x 219.1 x 60.3 8.625 x 8.625 x 2.375	196.9 7.75	14.8 32.7
200 x 200 x 80 8 x 8 x 3	219.1 x 219.1 x 88.9 8.625 x 8.625 x 3.500	196.9 7.75	15.2 33.5
200 x 200 x 100 8 x 8 x 4	219.1 x 219.1 x 114.3 8.625 x 8.625 x 4.500	196.9 7.75	15.6 34.5
200 x 200 x 125 8 x 8 x 5	219.1 x 219.1 x 141.3 8.625 x 8.625 x 5.563	196.9 7.75	15.7 34.7
200 x 200 x 150 8 x 8 x 165.1mm	219.1 x 219.1 x 165.1 8.625 x 8.625 x 6.500	196.9 7.75	16.1 35.6
200 x 200 x 150 8 x 8 x 6	219.1 x 219.1 x 168.3 8.625 x 8.625 x 6.625	196.9 7.75	16.1 35.6
250 x 250 x 50 10 x 10 x 2	273.0 x 273.0 x 60.3 10.750 x 10.750 x 2.375	228.6 9.00	23.7 52.2
250 x 250 x 80 10 x 10 x 3	273.0 x 273.0 x 88.9 10.750 x 10.750 x 3.500	228.6 9.00	24.0 53.0
250 x 250 x 100 10 x 10 x 4	273.0 x 273.0 x 114.3 10.750 x 10.750 x 4.500	228.6 9.00	24.3 53.6
250 x 250 x 125 10 x 10 x 5	273.0 x 273.0 x 141.3 10.750 x 10.750 x 5.563	228.6 9.00	24.6 54.2
250 x 250 x 150 10 x 10 x 6	273.0 x 273.0 x 168.3 10.750 x 10.750 x 6.625	228.6 9.00	24.9 54.9
250 x 250 x 200 10 x 10 x 8	273.0 x 273.0 x 219.1 10.750 x 10.750 x 8.625	228.6 9.00	25.1 55.3
300 x 300 x 80 12 x 12 x 3	323.9 x 323.9 x 88.9 12.750 x 12.750 x 3.500	254.0 10.00	33.8 74.6
300 x 300 x 100 12 x 12 x 4	323.9 x 323.9 x 114.3 12.750 x 12.750 x 4.500	254.0 10.00	34.1 75.1
300 x 300 x 125 12 x 12 x 5	323.9 x 323.9 x 141.3 12.750 x 12.750 x 5.563	254.0 10.00	34.3 75.6
300 x 300 x 150 12 x 12 x 6	323.9 x 323.9 x 168.3 12.750 x 12.750 x 6.625	254.0 10.00	34.6 76.2
300 x 300 x 200 12 x 12 x 8	323.9 x 323.9 x 219.1 12.750 x 12.750 x 8.625	254.0 10.00	34.6 76.3
300 x 300 x 250 12 x 12 x 10	323.9 x 323.9 x 273.0 12.750 x 12.750 x 10.750	254.0 10.00	35.2 77.6

◆ Contact GRINNELL for dimension details.  
Available with BSP or NPT threads.  
For information on larger sizes, contact GRINNELL Products.  
See fitting specifications on page 29.

Grooved  
Fittings

## Figures 391, 392 & 393 Adaptor Nipples

Tech Data Sheet: TFP1815



Grooved Fittings

**Figure 391**  
Fabricated Adaptor Nipple  
Groove x Male Thread

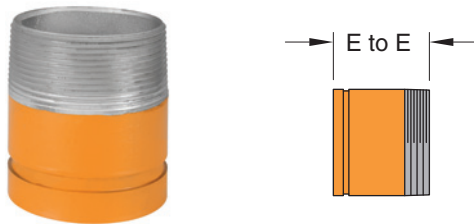

**Figure 392**  
Fabricated Adaptor Nipple  
Groove x Groove

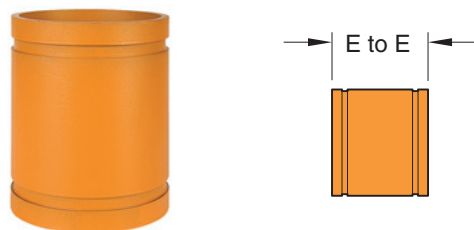

**Figure 393**  
Fabricated Adaptor Nipple  
Groove x Plain

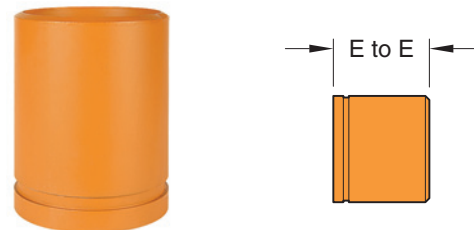

Pipe Size		E to E mm Inches	Approx. Weight kg Lbs.
Nominal mm Inches	O.D. mm Inches		
25	33.4	♦	♦
1	1.315	♦	♦
32	42.4	101.6	0.4
1-1/4	1.600	4.00	0.8
40	48.3	101.6	0.4
1-1/2	1.900	4.00	0.9
50	60.3	101.6	0.5
2	2.375	4.00	1.2
50 *	60.3	154.4	♦
2	2.375	6.00	♦
65	73.0	101.6	0.9
2-1/2	2.875	4.00	1.9
80	88.9	101.6	1.1
3	3.500	4.00	2.5
80 *	88.9	154.4	♦
3	3.500	6.00	♦
100	114.3	154.4	2.4
4	4.500	6.00	5.4
125	141.3	154.4	3.3
5	5.563	6.00	7.3
150	168.3	154.4	4.3
6	6.625	6.00	9.4
200	219.1	154.4	6.4
8	8.625	6.00	14.2
250	273.0	203.2	12.2
10	10.750	8.00	27.0
300	323.9	203.2	15.0
12	12.750	8.00	33.0

♦ Contact GRINNELL for dimension details.  
For information on larger sizes, contact GRINNELL Products.  
Figure 391 available with BSP or NPT threads. Contact GRINNELL Products for details.  
See fitting specifications on page 29.  
\* Figure 391 only



## Figure 372 Reducers, Small End Threaded (Male)

Tech Data Sheet: TFP1815

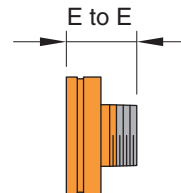

Grooved  
Fittings

Pipe Size		E to E mm Inches	Approx. Weight kg Lbs.
Nominal mm Inches	O.D. mm Inches		
40 x 25 1-1/2 x 1	48.3 x 33.7 1.900 x 1.315	63.5 2.50	0.3 0.6
40 x 32 1-1/2 x 1-1/4	48.3 x 42.4 1.900 x 1.660	◆ ◆	◆ ◆
50 x 20 2 x 3/4	60.3 x 26.7 2.375 x 1.050	63.5 2.50	0.5 1.0
50 x 25 2 x 1	63.0 x 33.7 2.375 x 1.315	63.5 2.50	0.4 0.8
50 x 32 2 x 1-1/4	63.0 x 42.4 2.375 x 1.660	63.5 2.50	0.4 0.8
50 x 40 2 x 1-1/2	63.0 x 48.3 2.375 x 1.900	63.5 2.50	0.4 0.8
65 x 25 2-1/2 x 1	73.0 x 33.4 2.875 x 1.315	◆ ◆	◆ ◆
65 x 32 2-1/2 x 1-1/4	73.0 x 42.4 2.875 x 1.660	63.5 2.50	0.5 1.0
65 x 40 2-1/2 x 1-1/2	73.0 x 48.3 2.875 x 1.900	63.5 2.50	0.6 1.3
65 x 50 2-1/2 x 2	73.0 x 60.3 2.875 x 2.375	63.5 2.50	0.5 1.2
80 x 20 3 x 3/4	88.9 x 26.7 3.500 x 1.050	◆ ◆	◆ ◆
80 x 25 3 x 1	88.9 x 33.7 3.500 x 1.315	63.5 2.50	0.6 1.3
80 x 40 3 x 1-1/2	88.9 x 48.3 3.500 x 1.900	63.5 2.50	0.6 1.3
80 x 50 3 x 2	88.9 x 60.3 3.500 x 2.375	63.5 2.50	0.6 1.3
80 x 65 3 x 2-1/2	88.9 x 73.0 3.500 x 2.875	63.5 2.50	0.7 1.5

Pipe Size		E to E mm Inches	Approx. Weight kg Lbs.
Nominal mm Inches	O.D. mm Inches		
90 x 80 3-1/2 x 3	101.6 x 88.9 4.000 x 3.500	63.5 2.50	0.7 1.5
100 x 25 4 x 1	114.3 x 33.4 4.500 x 1.315	76.2 3.00	0.8 1.8
100 x 40 4 x 1-1/2	114.3 x 48.3 4.500 x 1.900	76.2 3.00	1.0 2.3
100 x 50 4 x 2	114.3 x 60.3 4.500 x 2.375	76.2 3.00	1.0 2.3
100 x 65 4 x 2-1/2	114.3 x 73.0 4.500 x 2.875	76.2 3.00	1.0 2.3
100 x 80 4 x 3	114.3 x 88.9 4.500 x 3.500	76.2 3.00	1.2 2.6
125 x 100 5 x 4	141.3 x 114.3 5.563 x 4.500	88.9 3.50	2.0 4.5
150 x 25 6 x 1	168.3 x 33.4 6.625 x 1.315	101.6 4.00	2.4 5.2
150 x 50 6 x 2	168.3 x 60.3 6.625 x 2.375	101.6 4.00	2.7 6.0
150 x 65 6 x 2-1/2	168.3 x 73.0 6.625 x 2.875	101.6 4.00	2.7 6.0
150 x 80 6 x 3	168.3 x 88.9 6.625 x 3.500	101.6 4.00	2.7 6.0
150 x 100 6 x 4	168.3 x 114.3 6.625 x 4.500	101.6 4.00	2.7 5.9
150 x 125 6 x 5	168.3 x 141.3 6.625 x 5.563	101.6 4.00	2.6 5.8

◆ Contact GRINNELL for dimension details.  
Available with BSP or NPT threads. Contact GRINNELL Products for details.  
For information on larger sizes, Chinese sizes or other alternative sizes, contact GRINNELL Products.  
See fitting specifications on page 29.

## Figures 250 & 350 Concentric Reducers

(Page 1 of 2)

Tech Data Sheet: TFP1815



Figure 250  
Concentric Reducer Cast

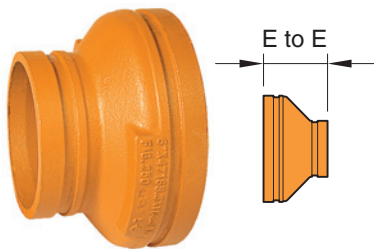
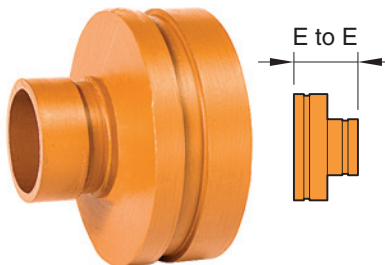

Figure 350  
Concentric Reducer Fabricated



Pipe Size		Figure 250 - Cast		Figure 350 - Fabricated	
Nominal mm Inches	O.D. mm Inches	E to E mm Inches	Approx. Weight kg Lbs.	E to E mm Inches	Approx. Weight kg Lbs.
32 x 20	42.4 x 26.7	—	—	♦	♦
1-1/4 x 3/4	1.660 x 1.050	—	—	♦	♦
32 x 25	42.4 x 33.4	63.5	0.3	—	—
1-1/4 x 1	1.660 x 1.315	2.50	0.7	—	—
40 x 20	48.3 x 26.7	—	—	♦	♦
1-1/2 x 3/4	1.900 x 1.050	—	—	♦	♦
40 x 25	48.3 x 33.4	63.5	0.3	—	—
1-1/2 x 1	1.900 x 1.315	2.50	0.7	—	—
40 x 32	48.3 x 42.4	63.5	0.3	—	—
1-1/2 x 1-1/4	1.900 x 1.660	2.50	0.8	—	—
50 x 20	60.3 x 26.7	—	—	♦	♦
2 x 3/4	2.375 x 1.050	—	—	♦	♦
50 x 25	60.3 x 33.4	63.5	0.4	—	—
2 x 1	2.375 x 1.315	2.50	0.9	—	—
50 x 32	60.3 x 42.4	63.5	0.4	—	—
2 x 1-1/4	2.375 x 1.660	2.50	0.9	—	—
50 x 40	60.3 x 48.3	63.5	0.5	—	—
2 x 1-1/2	2.375 x 1.900	2.50	1.0	—	—
65 x 25	73.0 x 33.4	—	—	63.5	0.5
2-1/2 x 1	2.875 x 1.315	—	—	2.50	1.2
65 x 32	73.0 x 42.4	63.5	0.6	—	—
2-1/2 x 1-1/4	2.875 x 1.660	2.50	1.4	—	—
65 x 40	73.0 x 48.3	63.5	0.6	—	—
2-1/2 x 1-1/2	2.875 x 1.900	2.50	1.4	—	—
65 x 50	73.0 x 60.3	63.5	0.6	—	—
2-1/2 x 2	2.875 x 2.375	2.50	1.3	—	—
65 x 32	76.1 x 42.4	63.5	0.6	—	—
76.1mm x 1-1/4	3.000 x 1.660	2.50	1.4	—	—
65 x 40	76.1 x 48.3	63.5	0.6	—	—
76.1mm x 1-1/2	3.000 x 1.900	2.50	1.4	—	—
65 x 50	76.1 x 60.3	63.5	0.7	—	—
76.1mm x 2	3.000 x 2.375	2.50	1.5	—	—
80 x 25	88.9 x 33.4	—	—	63.5	0.6
3 x 1	3.500 x 1.315	—	—	2.50	1.3
80 x 32	88.9 x 42.4	—	—	63.5	0.6
3 x 1-1/4	3.500 x 1.660	—	—	2.50	1.3
80 x 40	88.9 x 48.3	63.5	0.8	—	—
3 x 1-1/2	3.500 x 1.900	2.50	1.8	—	—
80 x 50	88.9 x 60.3	63.5	0.8	—	—
3 x 2	3.500 x 2.375	2.50	1.7	—	—
80 x 65	88.9 x 73.0	63.5	0.8	—	—
3 x 2-1/2	3.500 x 2.875	2.50	1.7	—	—
80 x 65	88.9 x 76.1	63.5	0.9	—	—
3 x 76.1mm	3.500 x 3.000	2.50	2.0	—	—
100 x 25	114.3 x 33.4	—	—	98.6	1.1
4 x 1	4.500 x 1.315	—	—	3.88	2.9
100 x 32	114.3 x 42.4	—	—	76.2	1.0
4 x 1-1/4	4.500 x 1.660	—	—	3.00	2.2
100 x 40	114.3 x 48.3	—	—	76.2	1.0
4 x 1-1/2	4.500 x 1.900	—	—	3.00	2.3
100 x 50	114.3 x 60.3	76.2	1.1	—	—
4 x 2	4.500 x 2.375	3.00	2.4	—	—
100 x 65	114.3 x 73.0	76.2	1.2	—	—
4 x 2-1/2	4.500 x 2.875	3.00	2.7	—	—
100 x 65	114.3 x 76.1	76.2	1.5	—	—
4 x 76.1mm	4.500 x 3.000	3.00	3.2	—	—
100 x 80	114.3 x 88.9	76.2	1.3	—	—
4 x 3	4.500 x 3.500	3.00	2.8	—	—
125 x 80	139.7 x 88.9	88.9	1.9	—	—
139.7mm x 3	5.500 x 3.500	3.50	4.2	—	—
125 x 100	139.7 x 114.3	88.9	2.0	—	—
139.7mm x 4	5.500 x 4.500	3.50	4.4	—	—
125 x 50	141.3 x 60.3	—	—	88.9	2.1
5 x 2	5.563 x 2.375	—	—	3.50	4.6
125 x 65	141.3 x 73.0	—	—	88.9	2.0
5 x 2-1/2	5.563 x 2.875	—	—	3.50	4.5

## Figures 250 & 350 Concentric Reducers

(Page 2 of 2)

Tech Data Sheet: TFP1815

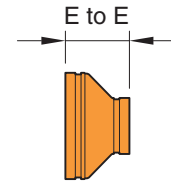
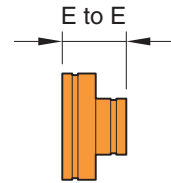

Pipe Size		Figure 250 - Cast		Figure 350 - Fabricated	
Nominal mm Inches	O.D. mm Inches	E to E Inches	Approx. Weight kg Lbs.	E to E Inches	Approx. Weight kg Lbs.
<b>125 x 80</b> 5 x 3	<b>141.3 x 88.9</b> 5.563 x 3.500	<b>88.9</b> 3.50	<b>1.9</b> 4.2	—	—
<b>125 x 100</b> 5 x 4	<b>141.3 x 114.3</b> 5.563 x 4.500	<b>88.9</b> 3.50	<b>2.0</b> 4.4	—	—
<b>150 x 80</b> 165.1mm x 3	<b>165.1 x 88.9</b> 6.500 x 3.500	<b>101.6</b> 4.00	<b>2.5</b> 5.5	—	—
<b>150 x 100</b> 165.1mm x 4	<b>165.1 x 114.3</b> 6.500 x 4.500	<b>101.6</b> 4.00	<b>2.7</b> 6.0	—	—
<b>150 x 125</b> 165.1 x 139.7mm	<b>165.1 x 139.7</b> 6.500 x 5.500	<b>101.6</b> 4.00	<b>2.5</b> 5.6	—	—
<b>150 x 25</b> 6 x 1	<b>168.3 x 33.4</b> 6.625 x 1.315	◆	◆	—	—
<b>150 x 40</b> 6 x 1-1/2	<b>168.3 x 48.3</b> 6.625 x 1.900	◆	◆	—	—
<b>150 x 50</b> 6 x 2	<b>168.3 x 60.3</b> 6.625 x 2.375	<b>101.6</b> 4.00	<b>2.4</b> 5.3	—	—
<b>150 x 65</b> 6 x 2-1/2	<b>168.3 x 73.0</b> 6.625 x 2.875	<b>101.6</b> 4.00	<b>2.6</b> 5.7	—	—
<b>150 x 65</b> 6 x 76.1mm	<b>168.3 x 76.1</b> 6.625 x 3.000	<b>101.6</b> 4.00	<b>2.7</b> 6.1	—	—
<b>150 x 80</b> 6 x 3	<b>168.3 x 88.9</b> 6.625 x 3.500	<b>101.6</b> 4.00	<b>2.6</b> 5.8	—	—
<b>150 x 100</b> 6 x 4	<b>168.3 x 114.3</b> 6.625 x 4.500	<b>101.6</b> 4.00	<b>2.7</b> 6.0	—	—
<b>150 x 125</b> 6 x 139.7mm	<b>168.3 x 139.7</b> 6.625 x 5.500	<b>101.6</b> 4.00	<b>2.3</b> 6.3	—	—
<b>150 x 125</b> 6 x 5	<b>168.3 x 141.3</b> 6.625 x 5.563	<b>101.6</b> 4.00	<b>2.8</b> 6.2	—	—
<b>200 x 65</b> ▶ 8 x 2-1/2	<b>219.1 x 73.0</b> 8.625 x 2.875	—	—	<b>127.0</b> 5.00	<b>5.5</b> 12.1
<b>200 x 80</b> ▶ 8 x 3	<b>219.1 x 88.9</b> 8.625 x 3.500	<b>127.0</b> 5.00	<b>5.2</b> 11.5	—	—
<b>200 x 100</b> ▶ 8 x 4	<b>219.1 x 114.3</b> 8.625 x 4.500	<b>127.0</b> 5.00	<b>4.9</b> 10.7	—	—
<b>200 x 125</b> ▶ 8 x 139.7mm	<b>219.1 x 139.7</b> 8.625 x 5.500	<b>127.0</b> 5.00	<b>4.5</b> 10.0	—	—
<b>200 x 125</b> ▶ 8 x 5	<b>219.1 x 141.3</b> 8.625 x 5.563	<b>127.0</b> 5.00	<b>4.9</b> 10.8	—	—
<b>200 x 150</b> ▶ 8 x 165.1mm	<b>219.1 x 165.1</b> 8.625 x 6.500	<b>127.0</b> 5.00	<b>5.0</b> 11.0	—	—
<b>200 x 150</b> ▶ 8 x 6	<b>219.1 x 168.3</b> 8.625 x 6.625	<b>127.0</b> 5.00	<b>5.1</b> 11.3	—	—
<b>250 x 100</b> ▶ 10 x 4	<b>273.0 x 114.3</b> 10.750 x 4.500	—	—	<b>152.4</b> 6.00	<b>9.3</b> 20.5
<b>250 x 125</b> ▶ 10 x 5	<b>273.0 x 141.3</b> 10.750 x 5.563	—	—	<b>152.4</b> 6.00	<b>9.1</b> 20.1
<b>250 x 150</b> ▶ 10 x 165.1mm	<b>273.0 x 165.1</b> 10.750 x 6.500	<b>152.4</b> 6.00	<b>8.0</b> 17.8	—	—
<b>250 x 150</b> ▶ 10 x 6	<b>273.0 x 168.3</b> 10.750 x 6.625	<b>152.4</b> 6.00	<b>7.4</b> 16.3	—	—
<b>250 x 200</b> ▶ 10 x 8	<b>273.0 x 219.1</b> 10.750 x 8.625	<b>152.4</b> 6.00	<b>8.3</b> 18.3	—	—
<b>300 x 100</b> ▶ 12 x 4	<b>323.9 x 114.3</b> 12.750 x 4.500	<b>177.8</b> 7.00	<b>10.3</b> 22.7	—	—
<b>300 x 150</b> ▶ 12 x 6	<b>323.9 x 168.3</b> 12.750 x 6.625	<b>177.8</b> 7.00	<b>11.0</b> 24.2	—	—
<b>300 x 200</b> ▶ 12 x 8	<b>323.9 x 219.1</b> 12.750 x 8.625	<b>177.8</b> 7.00	<b>11.7</b> 25.8	—	—
<b>300 x 250</b> ▶ 12 x 10	<b>323.9 x 273.0</b> 12.750 x 10.750	<b>177.8</b> 7.00	<b>12.8</b> 28.2	—	—

 Figure 250  
Cast Concentric  
Reducer

 Figure 350  
Fabricated Concentric  
Reducer

 Grooved  
Fittings

- ◆ Contact GRINNELL for dimension details.
  - ▶ Sizes are available to JIS standards. Contact GRINNELL Products for details.
- For information on larger sizes, contact GRINNELL Products.  
See fitting specifications on page 29.

## Figures 227 & 327 Crosses

Tech Data Sheet: TFP1815

**10**  
YEAR  
LIMITED  
WARRANTY

Figure 227  
Cast Cross

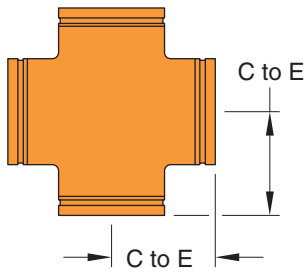
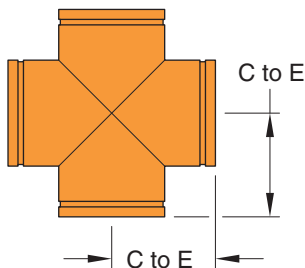

Figure 327  
Fabricated Cross



Pipe Size		Figure 227 - Cast		Figure 327 - Fabricated	
Nominal mm Inches	O.D. mm Inches	C to E mm Inches	Approx Weight Kg Lbs.	C to E mm Inches	Approx Weight Kg Lbs.
25	33.7	—	—	◆	◆
1	1.315	—	—	◆	◆
32	42.4	69.9	1.0	—	—
1-1/4	1.660	2.75	2.2	—	—
40	48.3	69.9	1.1	—	—
1-1/2	1.900	2.75	2.5	—	—
50	60.3	82.6	1.7	—	—
2	2.375	3.25	3.7	—	—
65	73.0	95.3	2.6	—	—
2-1/2	2.875	3.75	5.8	—	—
65	76.1	95.3	2.7	—	—
76.1mm	3.000	3.75	6.0	—	—
80	88.9	108.0	3.9	—	—
3	3.500	4.25	8.6	—	—
100	114.3	127.0	9.4	—	—
4	4.500	5.00	20.7	—	—
125	139.7	139.7	8.4	—	—
139.7mm	5.500	5.50	18.5	—	—
125	141.3	139.7	8.4	—	—
5	5.563	5.50	18.5	—	—
150	165.1	165.1	12.4	—	—
165.1mm	6.500	6.50	27.3	—	—
150	168.3	165.1	13.0	—	—
6	6.625	6.50	28.6	—	—
200	216.3	◆	◆		
216.3mm	8.500	◆	◆		
200	219.1	196.9	21.7	—	—
8	8.625	7.75	48.0	—	—
250	273.0	228.6	34.0	—	—
10	10.750	9.00	75.0	—	—
300	323.9	254.0	43.4	—	—
12	12.750	10.00	95.8	—	—

◆ Contact GRINNELL for dimension details.

For information on larger sizes, Chinese sizes or other alternative sizes, contact GRINNELL Products.

See fitting specifications on page 29.

Grooved  
Fittings

## Figure 750 ADACAP

Tech Data Sheet: TFP1815

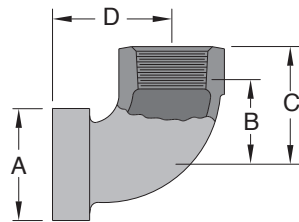

Grooved  
Fittings

Nominal Pipe Size		Outlet Size NPT * Threads	Dimensions - Inches mm			Approx. Weight Lbs. kg
Nominal Size Inches mm	A O.D. Inches mm		B	C	D	
<b>40</b> 1½	<b>48.3</b> 1.900	<b>15</b>	<b>31.8</b>	<b>44.5</b>	<b>48.0</b>	<b>0.37</b>
		½	1.25	1.75	1.89	0.82
		<b>20</b>	<b>31.8</b>	<b>44.5</b>	<b>48.0</b>	<b>0.38</b>
		¾	1.25	1.75	1.89	0.84
<b>50</b> 2	<b>60.3</b> 2.375	<b>25</b>	<b>34.8</b>	<b>50.8</b>	<b>51.3</b>	<b>0.42</b>
		1	1.37	2.00	2.02	0.92
		<b>15</b>	<b>31.8</b>	<b>44.5</b>	<b>48.0</b>	<b>0.41</b>
		½	1.25	1.75	1.89	0.90
<b>65</b> 2½	<b>73.0</b> 2.875	<b>20</b>	<b>31.8</b>	<b>44.5</b>	<b>48.0</b>	<b>0.36</b>
		¾	1.25	1.75	1.89	0.80
		<b>25</b>	<b>34.8</b>	<b>50.8</b>	<b>51.3</b>	<b>0.50</b>
		1	1.37	2.00	2.02	1.10
<b>65</b> 2½	<b>73.0</b> 2.875	<b>15</b>	<b>37.3</b>	<b>50.0</b>	<b>48.0</b>	<b>0.54</b>
		½	1.47	1.97	1.89	1.18
		<b>20</b>	<b>37.3</b>	<b>50.0</b>	<b>48.0</b>	<b>0.50</b>
		¾	1.47	1.97	1.89	1.10
<b>65</b> 2½	<b>73.0</b> 2.875	<b>25</b>	<b>34.8</b>	<b>50.8</b>	<b>51.3</b>	<b>0.48</b>
		1	1.37	2.00	2.02	1.06

Available with BSP or NPT threads. Contact GRINNELL Products for details.

\* ISO-7 threads outlets are available upon request

Rated pressure 20.7 bar (300psi)

See fitting specifications on page 29.

## Figures 260 & 360 End Caps

Tech Data Sheet: TFP1815



Figure 260 Cap  
Cast

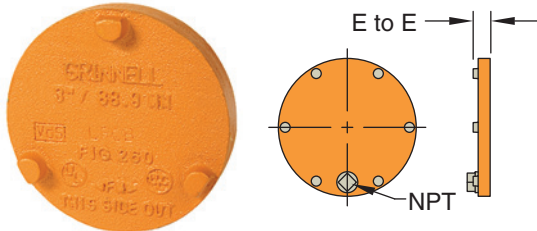

Figure 360 Cap  
Fabricated



Grooved  
Fittings

Figure 260/360 Cap with Tap			
Size mm (in)	15mm (½") Tap	20mm (¾") Tap	25mm (1") Tap
25 (1)	—	—	—
32 (1-¼)	—	—	—
40 (1-½)	—	—	—
50 (2)	•	—	—
65 (2-½)	•	•	—
65 (76mm)	•	•	—
80 (3)	•	•	•
100 (4)	•	•	•
125 (139mm)	•	•	•
125 (5)	•	•	•
150 (165mm)	•	•	•
150 (6)	•	•	•
200 (8)	•	•	•
250 (10)	•	•	•
300 (12)	•	•	•

Pipe Size		Figure 260 - Cast		Figure 360 - Fabricated	
Nominal mm Inches	O.D. mm Inches	E to E mm Inches	Approx Weight Kg Lbs.	E to E mm Inches	Approx Weight Kg Lbs.
25	33.7	—	—	21.1	0.1
1	1.315	—	—	0.83	0.3
32	42.4	21.1	0.2	—	—
1-¼	1.660	0.83	0.4	—	—
40	48.3	21.1	0.2	—	—
1-½	1.900	0.83	0.4	—	—
50	60.3	23.4	0.3	—	—
2	2.375	0.92	0.7	—	—
65	73.0	23.4	0.5	—	—
2-½	2.875	0.92	1.0	—	—
65	76.1	21.8	0.6	—	—
76.1mm	3.000	0.86	1.3	—	—
80	88.9	23.4	0.7	—	—
3	3.500	0.92	1.6	—	—
100	114.3	25.4	1.2	—	—
4	4.500	1.00	2.6	—	—
125	139.7	23.4	2.2	—	—
139.7mm	5.500	0.92	4.8	—	—
125	141.3	25.4	2.2	—	—
5	5.563	1.00	4.8	—	—
150	165.1	23.4	2.9	—	—
165.1mm	6.500	0.92	6.5	—	—
150	168.3	25.4	2.9	—	—
6	6.625	1.00	6.5	—	—
200	219.1	27.0	5.7	—	—
8	8.625	1.06	12.6	—	—
250	273.0	25.8	9.8	—	—
10	10.750	1.02	21.5	—	—
300	323.9	25.8	13.6	—	—
12	12.750	1.02	30.0	—	—

For information on larger sizes, Chinese sizes or other alternative sizes, contact GRINNELL Products.

See fitting specifications on page 29.

## Figure 343 Flange Adaptors (PN16) Figure 343 Flange Adaptors (PN10) Figure 344 Flange Adaptors (JIS)

Tech Data Sheet: TFP1815

**10**  
YEAR  
LIMITED  
WARRANTY

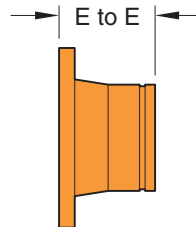

Pipe Size		Figure 343 - PN16#			Figure 343 - PN10			Figure 344 - JIS		
Nominal Inches mm	O.D. Inches mm	E to E Inches mm	Mating Flange Bolt Qty.	Approx. Weight Lbs. kg	E to E Inches mm	Mating Flange Bolt Qty.	Approx. Weight Lbs. kg	E to E Inches mm	Mating Flange Bolt Qty.	Approx. Weight Lbs. kg
25	33.4	◆	◆	◆	-	-	-	-	-	-
1	1.315	◆	◆	◆	-	-	-	-	-	-
32	42.4	◆	◆	◆	-	-	-	-	-	-
1-1/4	1.660	◆	◆	◆	-	-	-	-	-	-
40	48.3	◆	◆	◆	-	-	-	-	-	-
1-1/2	1.900	◆	◆	◆	-	-	-	-	-	-
50	60.3	95,0	4	2,3	-	-	-	-	-	-
2	2.375	3.74	4	5.07	-	-	-	-	-	-
65	73.0	◆	◆	◆	-	-	-	-	-	-
2-1/2	2.875	◆	◆	◆	-	-	-	-	-	-
65	76.1	95,0	4	3,3	-	-	-	-	-	-
76.1mm	3.000	3.74	4	7.27	-	-	-	-	-	-
80	88.9	100,0	4	4,0	-	-	-	-	-	-
3	3.500	3.94	4	8.82	-	-	-	-	-	-
100	114.3	102,0	8	4,6	-	-	-	-	-	-
4	4.500	4.02	8	10.14	-	-	-	-	-	-
125	139.7	105,0	8	6,0	-	-	-	-	-	-
139,7mm	5.500	4.13	8	13.23	-	-	-	-	-	-
125	141.3	◆	◆	◆	-	-	-	-	-	-
5	5.563	◆	◆	◆	-	-	-	-	-	-
150	165,1	105,0	8	7,2	-	-	-	105,0	8	7,2
165,1mm	6.500	4.13	8	15.87	-	-	-	4.13	8	15.87
150	168.3	105,0	8	7,2	-	-	-	-	-	-
6	6.625	4.13	8	15.87	-	-	-	-	-	-
200	216.3	-	-	-	-	-	-	112,0	12	10,2
216.3mm	8.625	-	-	-	-	-	-	4.41	12	22.49
200	219.1	112,0	12	10,2	112,0	8	10,2	-	-	-
8	8.625	4.41	12	22.49	4.41	8	22.49	-	-	-
250	267.4	-	-	-	-	-	-	138,0	12	18,0
267.4mm	10.750	-	-	-	-	-	-	5.43	12	39.68
250	273.0	138,0	12	18,0	138,0	12	18,0	-	-	-
10	10.750	5.43	12	39.68	5.43	12	39.68	-	-	-
300	318.5	-	-	-	-	-	-	138,0	12	22,4
318.5mm	12.750	-	-	-	-	-	-	5.43	12	49.38
300	323.9	138,0	12	22,4	138,0	12	22,4	-	-	-
12	12.750	5.43	12	49.38	5.43	12	49.38	-	-	-

◆ Contact GRINNELL for dimension details.  
For information on larger sizes, contact GRINNELL Products.  
See fitting specifications on page 29.  
See Flange Drilling Specifications on page 96.

## Figure 341 Flange Adaptors (ANSI Class 150#) Figure 343 Flange Adaptors (Table E)

Tech Data Sheet: TFP1815



Grooved  
Fittings

Pipe Size		Figure 341 - ANSI Class 150#			Figure 343 - Table E		
Nominal mm Inches	O.D. mm Inches	E to E mm Inches	Mating Flange Bolt Qty.	Approx. Weight kg Lbs.	E to E mm Inches	Mating Flange Bolt Qty.	Approx. Weight kg Lbs.
25 1	33.4 1.315	◆ ◆	◆ ◆	◆ ◆	◆ ◆	◆ ◆	◆ ◆
32 1¼	42.4 1.660	101.6 4.00	4	1.7 3.7	101.6 4.00	4	1.7 3.7
40 1½	48.3 1.900	101.6 4.00	4	1.8 3.9	101.6 4.00	4	1.8 3.9
50 2	60.3 2.375	101.6 4.00	4	2.8 6.4	101.6 4.00	4	2.8 6.4
65 2½	73.0 2.875	101.6 4.00	4	4.0 8.8	101.6 4.00	4	4.0 8.8
80 3	88.9 3.500	101.6 4.00	4	4.7 10.4	101.6 4.00	4	4.7 10.4
100 4	114.3 4.500	152.4 6.00	8	8.3 18.2	152.4 6.00	8	8.3 18.2
125 5	141.3 5.563	152.4 6.00	8	10.0 22.0	152.4 6.00	8	10.0 22.0
150 6	168.3 6.625	152.4 6.00	8	12.7 28.1	152.4 6.00	8	12.7 28.1
200 8	219.1 8.625	152.4 6.00	8	19.8 43.7	152.4 6.00	8	19.8 43.7
250 10	273.0 10.750	203.2 8.00	12	30.9 68.2	203.2 8.00	12	30.9 68.2
300 12	323.9 12.750	203.2 8.00	12	43.6 96.1	203.2 8.00	12	43.6 96.1

◆ Contact GRINNELL for dimension details.  
For information on larger sizes, contact GRINNELL Products.  
See fitting specifications on page 29.  
See Flange Drilling Specifications on page 96.





G-FIRE OUTLET  
FITTINGS

## Mechanical Tees Pictorial Table of Contents

### Threaded Tees & Crosses



**Figure 522**  
G-FIRE Sprinkler Outlet  
Page – 51



**Figure 730**  
Female Threaded Tees  
Pages – 52 - 54



**Figure 730**  
Female Threaded Crosses  
Pages – 52 - 54

### Grooved Tees & Crosses



**Figure 730**  
Grooved Tees  
Pages – 55 - 57



**Figure 730**  
Grooved Crosses  
Pages – 55 - 57

The Figure 730 Mechanical Tee is rated at 3,447 kPa (500 psi) on standard weight pipe. It can be used in place of a tee, a cross connection, or a welded outlet where a threaded or grooved outlet is needed. The Mechanical Tee is ideal for use in retrofit or equipment hookup installations as it can be positioned along the pipe at the proper location in the field, ensuring exact lineup of the branch outlet connection.

All Figure 730 Mechanical Tees are provided with a ductile iron lower housing section for increased strength and dependability. This design provides stability and rigidity while inhibiting damage to the pipe during tightening.

## MATERIAL SPECIFICATIONS

### Housing Specifications

- ASTM A 536 – Standard specification for ductile iron castings, Grade 65-45-12
- Tensile Strength, minimum 448,159 kPa (65,000 psi)
- Yield Strength, minimum 310,264 kPa (45,000 psi)
- Elongation in 50mm (2"), minimum 12%
- ASTM A 153 – Standard specification for hot-dip galvanising

### Bolt/Nut Specifications

- Carbon steel oval neck bolts and nuts are heat treated and conform to the physical properties of ASTM A 183 with a minimum tensile strength of 758,422 kPa (110,000 psi). Bolts and nuts are zinc electroplated to ASTM B 633.
- Gold colour coded metric bolts conforming to the physical properties of ASTM F 568M are available upon request. Contact GRINNELL Products.
- Stainless Steel nuts and bolts are UL listed and comply to UL requirements. Bolts conform to ASTM A 193M, Class 2, Austenitic Stainless Steel. Nuts conform to ASTM A 194 Type 316, Grade 8M.

### Gasket Specifications

- **Grade "E" EPDM** gaskets have a green colour code identification and conform to ASTM D 2000 for service temperatures from -34°C to 110°C (-30°F to 230°F). They are recommended for hot water not to exceed 110°C (230°F), plus a variety of dilute acids, oil free air, and many chemical services. They are not recommended for petroleum services.

### Coatings

- Red – Non-lead paint (standard)
- Orange – Non-lead paint (standard)
- Hot-Dipped, Zinc Galvanised (Optional)

Outlet  
Fittings



For Fire Protection Pressure Rating and Listing / Approval information contact Tyco Fire Protection Products.

## Figure 522 G-FIRE Threaded Sprinkler Outlet

Tech Data Sheet: TFP1865



The GRINNELL Figure 522 Sprinkler Outlet is an economical alternative to welded pipe outlets on steel pipe. The Figure 522 Sprinkler Outlet may be used with full lengths of pipe and eliminates threading and welding, decreasing waste and installation time. The Figure 522 Sprinkler Outlet may be used in wet pipe, dry pipe, and deluge systems.



For Fire Protection Pressure Rating and Listing / Approval information contact Tyco Fire Protection Products.

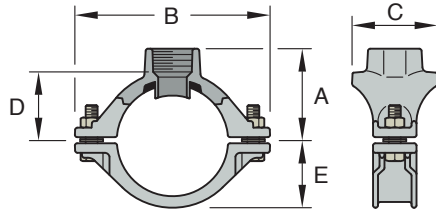

Nominal Pipe Size		Outlet Size ISO 7/1 or NPT Threads	Max. $\pm$ Outlet End Load kN Lbs.	Dimensions - mm Inches					Approx. Weight kg Lbs.
Nominal Size mm Inches	O.D. mm Inches			A	B	C	D	E	
25 1	33,7 1.315	15	0,738	25,4	86,4	49,3	14,3	25,4	0,4
		1/2	165.9	1.00	3.40	1.94	0.56	1.00	0.9
		20	1,156	41,7	86,4	49,3	29,0	25,4	0,5
		3/4	259.9	1.64	3.40	1.94	1.14	1.00	1.1
		25	1,156	46,5	86,4	57,2	32,0	25,4	0,5
1	259.9	1.83	3.40	2.25	1.26	1.00	1.1		
32 1 1/4	42,4 1.660	10	0,738	31,0	96,0	57,2	23,1	26,9	0,4
		3/8	165.9	1.22	3.78	2.25	0.91	1.06	0.9
		15	0,738	31,0	96,0	57,2	19,8	26,9	0,4
		1/2	165.9	1.22	3.78	2.25	0.78	1.06	0.9
		20	1,156	46,5	96,0	57,2	33,8	26,9	0,5
3/4	259.9	1.83	3.78	2.25	1.33	1.06	1.1		
25	1,81	50,8	96,0	57,2	36,6	26,9	0,6		
1	406.9	2.00	3.78	2.25	1.44	1.06	1.3		
40 1 1/2	48,3 1.900	15	0,738	33,5	101,6	57,2	22,4	31,8	0,5
		1/2	165.9	1.32	4.00	2.25	0.88	1.25	1.1
		20	1,156	49,0	101,6	57,2	36,3	31,8	0,5
		3/4	259.9	1.93	4.00	2.25	1.43	1.25	1.1
		25	1,81	53,6	101,6	57,2	39,4	31,8	0,6
1	406.9	2.11	4.00	2.25	1.55	1.25	1.3		
50 2	60,3 2.375	15	0,738	39,6	113,3	57,2	28,4	38,1	0,6
		1/2	165.9	1.56	4.46	2.25	1.12	1.50	1.3
		20	1,156	55,1	113,3	57,2	42,4	38,1	0,7
		3/4	259.9	2.17	4.46	2.25	1.67	1.50	1.5
		25	1,81	60,0	113,3	63,5	45,5	38,1	0,7
1	406.9	2.35	4.46	2.50	1.79	1.50	1.5		
65 2 1/2	73,0 2.875	15	0,738	50,8	130,0	57,2	39,6	42,9	0,7
		1/2	165.9	2.00	5.12	2.25	1.56	1.69	1.5
		20	1,156	63,5	130,0	57,2	50,8	42,9	0,8
		3/4	259.9	2.50	5.12	2.25	2.00	1.69	1.8
		25	1,81	69,6	130,0	63,5	54,4	42,9	0,8
1	406.9	2.70	5.12	2.50	2.14	1.69	1.8		
65 76,1mm	76,1 3.000	15	0,738	50,8	130,0	57,2	39,6	46,2	0,7
		1/2	165.9	2.00	5.12	2.25	1.56	1.82	1.5
		20	1,156	63,5	130,0	57,2	50,8	46,2	0,8
		3/4	259.9	2.50	5.12	2.25	2.00	1.82	1.8
		25	1,81	69,9	130,0	63,5	55,6	46,2	0,8
1	406.9	2.75	5.12	2.50	2.19	1.82	1.8		

See page 50 for mechanical tee specifications, and see pages 76 - 78 for gasket information.

Available with BSP or NPT threads. Contact GRINNELL Products for details.

Refer to back cover for country-specific contact information.

## Figure 730 Mechanical Tees & Crosses – Threaded

(Page 1 of 3)

Tech Data Sheet: TFP1860

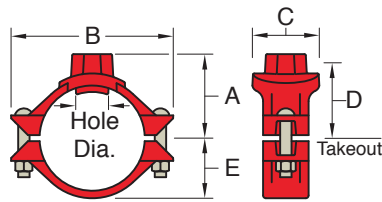

Figure 730 Branch Outlet with Female NPT/BSP Threaded Branch (Tee Configuration)

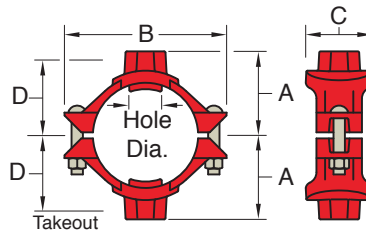

Figure 730 Branch Outlet with Female NPT/BSP Threaded Branch (Cross Configuration)

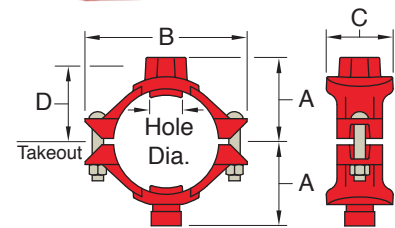

Figure 730 Branch Outlet with a Female NPT/BSP Threaded Branch and a Grooved Branch (Cross Configuration)

Outlet Fittings

Nominal Size Run x Branch mm Inches	Hole Dia. †		Max. ‡ Branch End Load kN Lbs.	Dimensions - mm Inches					Bolt Size mm Inches	Tee Approx. Weight kg Lbs.	Cross Approx. Weight kg Lbs.
	Min. mm Inches	Max. mm Inches		A	B	C	D	E			
50 x 15 2 x 1/2	38.1 1.50	41.3 1.63	1.2 277.1	66.5 2.62	124.0 4.88	78.0 3.07	53.8 2.12	40.4 1.59	M10 x 57 3/8 x 2-1/4	1.1 2.5	1.5 3.4
50 x 20 2 x 3/4	38.1 1.50	41.3 1.63	1.9 433.0	66.5 2.62	124.0 4.88	78.0 3.07	53.8 2.12	40.4 1.59	M10 x 57 3/8 x 2-1/4	1.0 2.3	1.4 3.0
50 x 25 2 x 1	38.1 1.50	41.3 1.63	3.0 679.1	66.5 2.62	124.0 4.88	78.0 3.07	53.8 2.12	40.4 1.59	M10 x 57 3/8 x 2-1/4	1.0 2.2	1.5 3.2
50 x 32 2 x 1-1/4	44.5 1.75	47.6 1.88	4.8 1082.1	70.6 2.78	124.0 4.88	84.3 3.32	49.0 1.93	40.4 1.59	M10 x 57 3/8 x 2-1/4	1.1 2.4	1.5 3.4
50 x 40 2 x 1-1/2	44.5 1.75	47.6 1.88	6.3 1417.6	69.9 2.75	124.0 4.88	84.3 3.32	49.0 1.93	40.4 1.59	M10 x 57 3/8 x 2-1/4	1.1 2.5	1.8 3.9
65 x 15 2-1/2 x 1/2	38.1 1.50	41.3 1.63	1.2 277.1	73.2 2.88	133.4 5.25	78.0 3.07	60.5 2.38	46.0 1.81	M10 x 57 3/8 x 2-1/4	1.1 2.4	1.5 3.4
65 x 20 2-1/2 x 3/4	38.1 1.50	41.3 1.63	1.9 433.0	73.2 2.88	133.4 5.25	78.0 3.07	60.5 2.38	46.0 1.81	M10 x 57 3/8 x 2-1/4	1.1 2.4	1.5 3.4
65 x 25 2-1/2 x 1	38.1 1.50	41.3 1.63	3.0 679.1	73.2 2.88	133.4 5.25	78.0 3.07	60.5 2.38	46.0 1.81	M10 x 57 3/8 x 2-1/4	1.1 2.4	1.5 3.4
65 x 32 2-1/2 x 1-1/4	50.8 2.00	54.0 2.13	4.8 1082.1	76.2 3.00	133.4 5.25	90.4 3.56	55.6 2.19	46.0 1.81	M10 x 57 3/8 x 2-1/4	1.1 2.5	1.7 3.8
65 x 40 2-1/2 x 1-1/2	50.8 2.00	54.0 2.13	6.3 1417.6	78.0 3.07	133.4 5.25	91.2 3.59	55.1 2.17	46.0 1.81	M10 x 57 3/8 x 2-1/4	1.2 2.6	1.9 4.1
65 x 50 2-1/2 x 2	50.8 2.00	54.0 2.13	9.9 2215.1	81.0 3.19	133.4 5.25	101.6 4.00	62.0 2.44	46.0 1.81	M10 x 57 3/8 x 2-1/4	1.2 2.7	1.9 4.1
65 x 15 76.1mm x 1/2	38.1 1.50	41.3 1.63	1.2 277.1	74.5 2.94	142.7 5.62	78.0 3.07	62.0 2.44	47.5 1.87	M10 x 57 -	1.1 2.5	1.6 3.5
65 x 20 76.1mm x 3/4	38.1 1.50	41.3 1.63	1.9 433.0	74.5 2.94	142.7 5.62	78.0 3.07	62.0 2.44	47.5 1.87	M10 x 57 -	1.1 2.5	1.6 3.5
65 x 25 76.1mm x 1	38.1 1.50	41.3 1.63	3.0 679.1	74.5 2.94	142.7 5.62	78.0 3.07	62.0 2.44	47.5 1.87	M10 x 57 -	1.1 2.5	1.6 3.5
65 x 32 76.1mm x 1-1/4	50.8 2.00	54.0 2.13	4.8 1082.1	77.7 3.06	142.7 5.62	90.4 3.56	57.2 2.25	47.5 1.87	M10 x 57 -	1.5 3.3	2.3 5.1
65 x 40 76.1mm x 1-1/2	50.8 2.00	54.0 2.13	6.3 1417.6	79.5 3.13	142.7 5.62	90.4 3.56	57.2 2.25	47.5 1.87	M10 x 57 -	1.6 3.6	2.6 5.7
65 x 50 76.1mm x 2	50.8 2.00	54.0 2.13	9.9 2215.1	82.6 3.25	142.7 5.62	101.6 4.00	63.5 2.50	47.5 1.87	M10 x 57 -	1.7 3.7	2.6 5.8
80 x 15 3 x 1/2	38.1 1.50	41.3 1.63	1.2 277.1	81.0 3.19	155.7 6.13	78.0 3.07	65.0 2.56	56.1 2.21	M12 x 89 1/2 x 3	1.7 3.7	2.4 5.2

## Figure 730 Mechanical Tees & Crosses – Threaded

(Page 2 of 3)

Tech Data Sheet: TFP1860

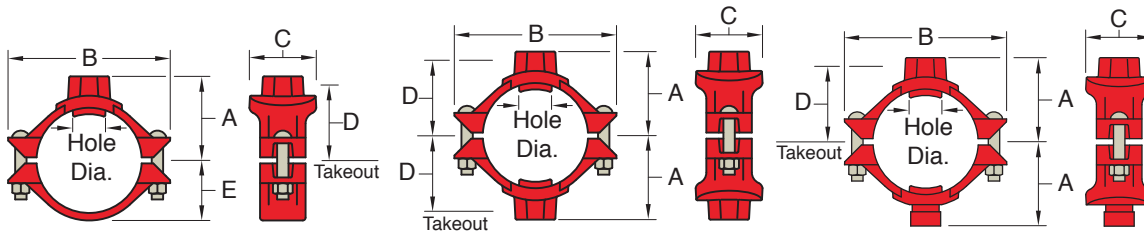

Figure 730 Branch Outlet with Female NPT/BSP Threaded Branch (Tee Configuration)

Figure 730 Branch Outlet with Female NPT/BSP Threaded Branch (Cross Configuration)

Figure 730 Branch Outlet with a Female NPT/BSP Threaded Branch and a Grooved Branch (Cross Configuration)

Nominal Size Run x Branch mm Inches	Hole Dia. †		Max. ‡ Branch End Load kN Lbs.	Dimensions - mm Inches					Bolt Size mm Inches	Tee Approx. Weight kg Lbs.	Cross Approx. Weight kg Lbs.
	Min. mm Inches	Max. mm Inches		A	B	C	D	E			
80 x 20 3 x 3/4	38.1 1.50	41.3 1.63	1.9 433.0	81.0 3.19	155.7 6.13	78.0 3.07	65.0 2.56	56.1 2.21	M12 x 89 1/2 x 3	1.7 3.7	2.4 5.2
80 x 25 3 x 1	38.1 1.50	41.3 1.63	3.0 679.1	81.0 3.19	155.7 6.13	78.0 3.07	65.0 2.56	56.1 2.21	M12 x 89 1/2 x 3	1.7 3.7	2.4 5.2
80 x 32 3 x 1-1/4	44.5 1.75	47.6 1.88	4.8 1082.1	84.8 3.34	155.7 6.13	84.3 3.32	63.5 2.50	56.1 2.21	M12 x 89 1/2 x 3	1.6 3.5	2.1 4.6
80 x 40 3 x 1-1/2	50.8 2.00	54.0 2.13	6.3 1417.6	85.9 3.38	155.7 6.13	90.4 3.56	63.0 2.48	56.1 2.21	M12 x 89 1/2 x 3	1.7 3.7	2.4 5.2
80 x 50 3 x 2	63.5 2.50	66.7 2.63	9.9 2215.1	88.9 3.50	155.7 6.13	103.9 4.09	69.9 2.75	56.1 2.21	M12 x 89 1/2 x 3	2.1 4.7	3.1 6.8
100 x 15 4 x 1/2	38.1 1.50	41.3 1.63	1.2 277.1	93.7 3.69	181.1 7.13	78.0 3.07	77.7 3.06	70.6 2.78	M12 x 89 1/2 x 3	2.2 4.8	2.5 5.6
100 x 20 4 x 3/4	38.1 1.50	41.3 1.63	1.9 433.0	93.7 3.69	181.1 7.13	78.0 3.07	77.7 3.06	70.6 2.78	M12 x 89 1/2 x 3	2.2 4.8	2.5 5.6
100 x 25 4 x 1	38.1 1.50	41.3 1.63	3.0 679.1	93.7 3.69	181.1 7.13	78.0 3.07	77.7 3.06	70.6 2.78	M12 x 89 1/2 x 3	2.2 4.8	2.5 5.6
100 x 32 4 x 1-1/4	44.5 1.75	47.6 1.88	4.8 1082.1	99.6 3.92	181.1 7.13	84.3 3.32	76.2 3.00	70.6 2.78	M12 x 89 1/2 x 3	2.2 4.8	2.5 5.6
100 x 40 4 x 1-1/2	50.8 2.00	54.0 2.13	6.3 1417.6	101.6 4.00	181.1 7.13	90.4 3.56	75.7 2.98	70.6 2.78	M12 x 89 1/2 x 3	2.3 5.1	2.5 6.4
100 x 50 4 x 2	63.5 2.50	66.7 2.63	9.9 2215.1	101.6 4.00	181.1 7.13	103.1 4.06	82.6 3.25	70.6 2.78	M12 x 89 1/2 x 3	2.5 5.5	3.3 7.3
100 x 65 4 x 2-1/2	69.9 2.75	73.0 2.88	14.4 3245.9	101.6 4.00	181.1 7.13	111.3 4.38	79.2 3.12	70.6 2.78	M12 x 89 1/2 x 3	2.8 6.2	3.9 8.7
100 x 65 4 x 76.1mm	69.9 2.75	73.0 2.88	15.7 3534.3	101.6 4.00	181.1 7.13	111.3 4.38	79.2 3.12	70.6 2.78	M12 x 89 -	2.8 6.2	3.9 8.7
100 x 80 4 x 3	88.9 3.50	92.1 3.63	21.4 4810.6	104.9 4.13	181.1 7.13	130.3 5.13	84.1 3.31	70.6 2.78	M12 x 89 1/2 x 3	3.5 7.8	5.4 11.9
125 x 40 5 x 1-1/2	50.8 2.00	54.0 2.13	6.3 1417.6	117.6 4.63	206.5 8.13	90.4 3.56	101.6 4.00	85.6 3.37	M16 x 121 5/8 x 4-3/4	3.5 7.8	4.3 9.4
125 x 50 5 x 2	63.5 2.50	66.7 2.63	9.9 2215.1	117.6 4.63	206.5 8.13	103.1 4.06	98.6 3.88	85.6 3.37	M16 x 121 5/8 x 4-3/4	3.5 7.8	4.3 9.4
125 x 65 5 x 2-1/2	69.9 2.75	73.0 2.88	14.4 3245.9	120.7 4.75	206.5 8.13	111.3 4.38	98.6 3.88	85.6 3.37	M16 x 121 5/8 x 4-3/4	4.0 8.9	5.2 11.5
125 x 65 5 x 76.1mm	69.9 2.75	73.0 2.88	15.7 3534.3	120.7 4.75	206.5 8.13	111.3 4.38	98.6 3.88	85.6 3.37	M16 x 121 -	4.0 8.9	5.2 11.5
125 x 80 5 x 3	88.9 3.50	92.1 3.63	21.4 4810.6	127.0 5.00	206.5 8.13	130.3 5.13	103.1 4.06	85.6 3.37	M16 x 121 5/8 x 4-3/4	5.8 12.7	6.0 13.3
150 x 32 165.1mm x 1-1/4	50.8 2.00	54.0 2.13	4.8 1082.1	130.3 5.13	235.0 9.25	90.4 3.56	108.0 4.25	99.1 3.90	M16 x 121 -	3.5 7.7	4.3 9.5
150 x 40 165.1mm x 1-1/2	50.8 2.00	54.0 2.13	6.3 1417.6	130.3 5.13	235.0 9.25	90.4 3.56	102.6 4.04	99.1 3.90	M16 x 121 -	3.5 7.7	4.3 9.5
150 x 50 165.1mm x 2	63.5 2.50	66.7 2.63	9.9 2215.1	130.3 5.13	235.0 9.25	103.1 4.06	109.5 4.31	99.1 3.90	M16 x 121 -	3.7 8.2	4.3 9.5
150 x 65 165.1mm x 2-1/2	69.9 2.75	73.0 2.88	14.4 3245.9	130.3 5.13	235.0 9.25	111.3 4.38	106.2 4.18	99.1 3.90	M16 x 121 -	4.1 9.0	5.1 11.3

Outlet Fittings

## Figure 730 Mechanical Tees & Crosses – Threaded

(Page 3 of 3)

Tech Data Sheet: TFP1860

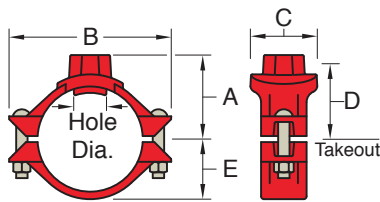

Figure 730 Branch Outlet with Female NPT/BSP Threaded Branch (Tee Configuration)

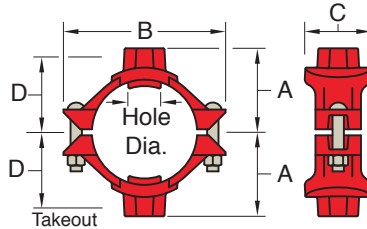

Figure 730 Branch Outlet with Female NPT/BSP Threaded Branch (Cross Configuration)

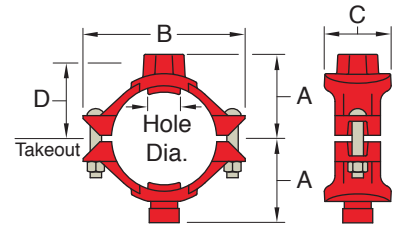

Figure 730 Branch Outlet with a Female NPT/BSP Threaded Branch and a Grooved Branch (Cross Configuration)

Outlet Fittings

Nominal Size Run x Branch mm Inches	Hole Dia.†		Max. ‡ Branch End Load kN Lbs.	Dimensions - mm Inches					Bolt Size mm Inches	Tee Approx. Weight kg Lbs.	Cross Approx. Weight kg Lbs.
	Min. mm Inches	Max. mm Inches		A	B	C	D	E			
150 x 65 165.1mm x 76.1mm	69.9 2.75	73.0 2.88	15.7 3584.3	130.3 5.13	235.0 9.25	111.3 4.38	106.2 4.18	99.1 3.90	M16 x 121 -	4.1 9.0	5.1 11.3
150 x 80 165.1mm x 3	88.9 3.50	92.1 3.63	21.4 4810.6	139.7 5.50	235.0 9.25	130.3 5.13	111.0 4.37	99.1 3.90	M16 x 121 -	4.8 10.5	6.4 14.1
150 x 100 165.1mm x 4	114.3 4.50	117.5 4.63	35.4 7952.2	136.7 5.38	235.0 9.25	155.7 6.13	115.8 4.56	99.1 3.90	M16 x 121 -	5.5 12.1	7.8 17.3
150 x 32 6 x 1-1/4	50.8 2.00	54.0 2.13	4.8 1082.1	130.3 5.13	235.0 9.25	90.4 3.56	108.0 4.25	99.1 3.90	M16 x 121 5/8 x 4-3/4	3.4 7.5	3.9 8.7
150 x 40 6 x 1-1/2	50.8 2.00	54.0 2.13	6.3 1417.6	130.3 5.13	235.0 9.25	90.4 3.56	102.6 4.04	99.1 3.90	M16 x 121 5/8 x 4-3/4	3.4 7.5	3.9 8.7
150 x 50 6 x 2	63.5 2.50	66.7 2.63	9.9 2215.1	130.3 5.13	235.0 9.25	103.1 4.06	109.5 4.31	99.1 3.90	M16 x 121 5/8 x 4-3/4	3.5 7.7	4.3 9.5
150 x 65 6 x 2-1/2	69.9 2.75	73.0 2.88	14.4 3245.9	130.3 5.13	235.0 9.25	111.3 4.38	106.2 4.18	99.1 3.90	M16 x 121 5/8 x 4-3/4	4.0 8.9	5.1 11.3
150 x 65 6 x 76.1mm	69.9 2.75	73.0 2.88	14.4 3245.9	130.3 5.13	235.0 9.25	111.3 4.38	106.2 4.18	99.1 3.90	M16 x 121 5/8 x 4-3/4	4.0 8.9	5.1 11.3
150 x 80 6 x 3	88.9 3.50	92.1 3.63	21.4 4810.6	139.7 5.50	235.0 9.25	130.3 5.13	111.0 4.37	99.1 3.90	M16 x 121 5/8 x 4-3/4	4.7 10.3	6.4 14.1
150 x 100 6 x 4	114.3 4.50	117.5 4.63	35.4 7952.2	136.7 5.38	235.0 9.25	155.7 6.13	115.8 4.56	99.1 3.90	M16 x 121 5/8 x 4-3/4	5.4 11.9	7.8 17.3
200 x 50 8 x 2	69.9 2.75	73.0 2.88	14.4 3245.9	158.8 6.25	317.5 12.50	103.1 4.06	130.0 5.12	124.5 4.90	M20 x 121 3/4 x 4-3/4	5.5 12.1	6.4 14.1
200 x 65 8 x 2-1/2	69.9 2.75	73.0 2.88	14.4 3245.9	158.8 6.25	317.5 12.50	111.3 4.38	130.0 5.12	124.5 4.90	M20 x 121 3/4 x 4-3/4	5.7 12.6	6.8 15.0
200 x 65 8 x 76.1mm	69.9 2.75	73.0 2.88	15.7 3534.3	158.8 6.25	317.5 12.50	111.3 4.38	130.0 5.12	124.5 4.90	M20 x 121 -	5.7 12.6	6.8 15.0
200 x 80 8 x 3	88.9 3.50	92.1 3.63	21.4 4810.6	165.1 6.50	317.5 12.50	130.3 5.13	136.4 5.37	124.5 4.90	M20 x 121 3/4 x 4-3/4	6.1 13.6	7.7 16.9
200 x 100 8 x 4	114.3 4.50	117.5 4.63	35.4 7952.2	162.1 6.38	317.5 12.50	155.7 6.13	141.2 5.56	124.5 4.90	M20 x 121 3/4 x 4-3/4	6.9 15.2	9.1 20.0

† Proper hole preparation is required for effective sealing and performance. Check the pipe seal surface within 15.9mm (5/8") of the hole to ensure it is free from conditions affecting proper gasket sealing. Remove any sharp or rough edges from the hole or upper housing contact area that might affect assembly, proper seating of the locating collar, or flow from the outlet. For crosses, ensure double outlet holes are aligned on opposite sides of the pipe. The use of threaded products other than steel pipe, such as dry pendent sprinklers, may not be compatible with the female threaded outlet on the Mechanical Tee. Always confirm compatibility by contacting GRINNELL Products.

‡ Maximum pressures and end loads are total from all loads based on standard weight steel pipe. Pressure ratings and end loads may differ on other pipe materials and/or wall thickness. Contact GRINNELL Products for details.

Threads are BSP. Some size outlets are available with NPT threads. Contact GRINNELL Products for details.

For information on larger sizes, Chinese sizes or other alternative sizes, contact GRINNELL Products.

See page 50 for mechanical tee specifications, and see pages 76 - 78 for gasket information.

## Figure 730 Mechanical Tees & Crosses – Grooved

(Page 1 of 3)

Tech Data Sheet: TFP1860

**10**  
YEAR  
LIMITED  
WARRANTY

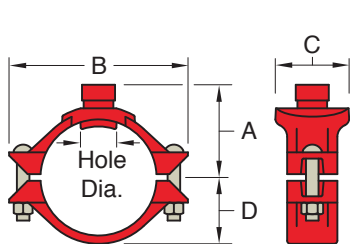
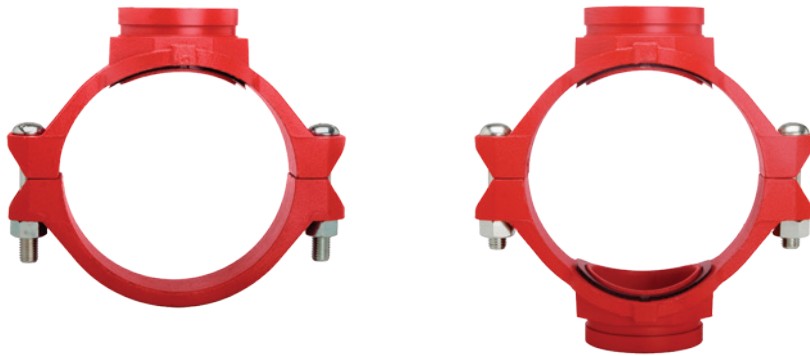

Figure 730 Branch Outlet with Grooved Branch (Tee Configuration)

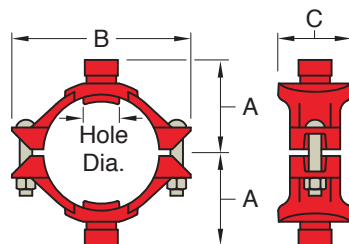

Figure 730 Branch Outlet with Grooved Branch (Cross Configuration)

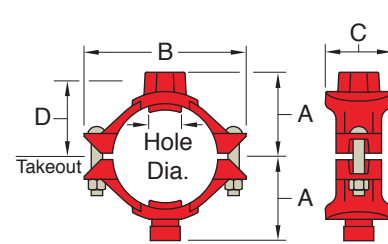

Figure 730 Branch Outlet with a Female NPT/BSP Threaded Branch and a Grooved Branch (Cross Configuration)

Outlet Fittings

Nominal Size Run x Branch mm Inches	Hole Dia. †		Max. ‡ End Load Branch kN Lbs.	Dimensions - mm Inches				Bolt Size mm Inches	Tee Approx. Weight kg Lbs.	Cross Approx. Weight kg Lbs.
	Min. mm Inches	Max. mm Inches		A	B	C	D			
50 x 32 2 x 1-1/4	44.5 1.75	47.6 1.88	4.8 1082.1	70.6 2.78	124.0 4.88	84.3 3.32	40.4 1.59	M10 x 57 3/8 x 2-1/4	1.1 2.5	1.5 3.3
50 x 40 2 x 1-1/2	44.5 1.75	47.6 1.88	6.3 1417.6	66.5 2.62	124.0 4.88	84.3 3.32	40.4 1.59	M10 x 57 3/8 x 2-1/4	1.1 2.4	1.7 3.7
65 x 32 2-1/2 x 1-1/4	50.8 2.00	54.0 2.13	4.8 1082.1	76.2 3.00	133.4 5.25	90.4 3.56	46.0 1.81	M10 x 57 3/8 x 2-1/4	1.1 2.5	1.7 3.8
65 x 40 2-1/2 x 1-1/2	50.8 2.00	54.0 2.13	6.3 1417.6	78.0 3.07	133.4 5.25	91.2 3.59	46.0 1.81	M10 x 57 3/8 x 2-1/4	1.1 2.5	1.8 3.9
65 x 50 2-1/2 x 2	50.8 2.00	54.0 2.13	9.9 2215.1	81.0 3.19	133.4 5.25	101.6 4.00	46.0 1.81	M10 x 57 3/8 x 2-1/4	1.1 2.5	1.7 3.8
65 x 32 76.1mm x 1-1/4	50.8 2.00	54.0 2.13	4.8 1082.1	77.7 3.06	142.7 5.62	90.4 3.56	47.5 1.87	M10 x 57 -	1.1 2.5	1.7 3.8
65 x 40 76.1mm x 1-1/2	50.8 2.00	54.0 2.13	6.3 1417.6	79.5 3.13	142.7 5.62	90.4 3.56	47.5 1.87	M10 x 57 -	1.1 2.5	1.8 3.9
65 x 50 76.1mm x 2	50.8 2.00	54.0 2.13	9.9 2215.1	82.6 3.25	142.7 5.62	101.6 4.00	47.5 1.87	M10 x 57 -	1.1 2.5	1.7 3.8
80 x 32 3 x 1-1/4	44.5 1.75	47.6 1.88	4.8 1082.1	84.8 3.34	155.7 6.13	84.3 3.32	56.1 2.21	M12 x 89 1/2 x 3	1.6 3.5	2.1 4.6
80 x 40 3 x 1-1/2	50.8 2.00	54.0 2.13	6.3 1417.6	85.9 3.38	155.7 6.13	90.4 3.56	56.1 2.21	M12 x 89 1/2 x 3	1.6 3.6	2.3 5.0
80 x 50 3 x 2	63.5 2.50	66.7 2.63	9.9 2215.1	88.9 3.50	155.7 6.13	103.9 4.09	56.1 2.21	M12 x 89 1/2 x 3	2.0 4.5	2.9 6.4
100 x 32 4 x 1-1/4	44.5 1.75	47.6 1.88	4.8 1082.1	99.6 3.92	181.1 7.13	84.3 3.32	70.6 2.78	M12 x 89 1/2 x 3	2.2 4.8	2.5 5.6
100 x 40 4 x 1-1/2	50.8 2.00	54.0 2.13	6.3 1417.6	101.6 4.00	181.1 7.13	90.4 3.56	70.6 2.78	M12 x 89 1/2 x 3	2.3 5.0	2.8 6.2

## Figure 730 Mechanical Tees & Crosses – Grooved

(Page 2 of 3)

Tech Data Sheet: TFP1860

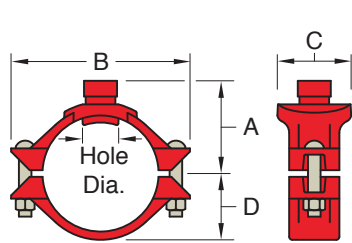

Figure 730 Branch Outlet with Grooved Branch (Tee Configuration)

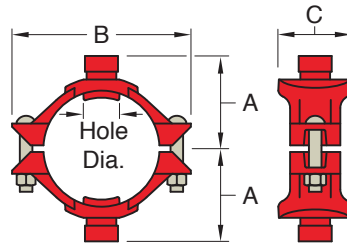

Figure 730 Branch Outlet with Grooved Branch (Cross Configuration)

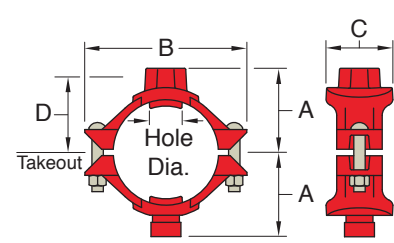

Figure 730 Branch Outlet with a Female NPT/BSP Threaded Branch and a Grooved Branch (Cross Configuration)

Outlet Fittings

Nominal Size Run x Branch mm Inches	Hole Dia. †		Max. ‡ End Load Branch kN Lbs.	Dimensions - mm Inches				Bolt Size mm Inches	Tee Approx. Weight kg Lbs.	Cross Approx. Weight kg Lbs.
	Min. mm Inches	Max. mm Inches		A	B	C	D			
<b>100 x 50</b> 4 x 2	63.5 2.50	66.7 2.63	9.9 2215.1	101.6 4.00	181.1 7.13	103.1 4.06	70.6 2.78	M12 x 89 ½ x 3	2.4 5.3	3.1 6.9
<b>100 x 65</b> 4 x 2½	69.9 2.75	73.0 2.88	14.4 3245.9	101.6 4.00	181.1 7.13	111.3 4.38	70.6 2.78	M12 x 89 ½ x 3	2.7 5.9	3.7 8.2
<b>100 x 65</b> 4 x 76.1mm	69.9 2.75	73.0 2.88	15.7 3534.3	101.6 4.00	181.1 7.13	111.3 4.38	70.6 2.78	M12 x 89 —	2.7 5.9	3.7 8.2
<b>100 x 80</b> 4 x 3	88.9 3.50	92.1 3.63	21.4 4810.6	104.9 4.13	181.1 7.13	130.3 5.13	70.6 2.78	M12 x 89 ½ x 3	3.4 7.4	5.0 11.1
<b>125 x 40</b> 5 x 1½	50.8 2.00	54.0 2.13	6.3 1417.6	117.6 4.63	206.5 8.13	90.4 3.56	85.6 3.37	M16 x 121 ⅝ x 4¾	3.5 7.7	4.2 9.2
<b>125 x 50</b> 5 x 2	63.5 2.50	66.7 2.63	9.9 2215.1	117.6 4.63	206.5 8.13	103.1 4.06	85.6 3.37	M16 x 121 ⅝ x 4¾	3.4 7.6	4.1 9.0
<b>125 x 65</b> 5 x 2½	69.9 2.75	73.0 2.88	14.4 3245.9	120.7 4.75	206.5 8.13	111.3 4.38	85.6 3.37	M16 x 121 ⅝ x 4¾	3.9 8.6	5.0 11.0
<b>125 x 65</b> 5 x 76.1mm	69.9 2.75	73.0 2.88	15.7 3534.3	120.7 4.75	206.5 8.13	111.3 4.38	85.6 3.37	M16 x 121 —	3.9 8.6	5.0 11.0
<b>125 x 80</b> 5 x 3	88.9 3.50	92.1 3.63	21.4 4810.6	127.0 5.00	206.5 8.13	130.3 5.13	85.6 3.37	M16 x 121 ⅝ x 4¾	5.6 12.3	5.7 12.5
<b>150 x 32</b> 165.1mm x 1¼	50.8 2.00	54.0 2.13	4.8 1082.1	130.3 5.13	235.0 9.25	90.4 3.56	99.1 3.90	M16 x 121 —	3.5 7.7	4.3 9.5
<b>150 x 40</b> 165.1mm x 1½	50.8 2.00	54.0 2.13	6.3 1417.6	130.3 5.13	235.0 9.25	90.4 3.56	99.1 3.90	M16 x 121 —	3.4 7.6	4.2 9.3
<b>150 x 50</b> 165.1mm x 2	63.5 2.50	66.7 2.63	9.9 2215.1	130.3 5.13	235.0 9.25	103.1 4.06	99.1 3.90	M16 x 121 —	3.6 8.0	4.1 9.1
<b>150 x 65</b> 165.1mm x 2½	69.9 2.75	73.0 2.88	14.4 3245.9	130.3 5.13	235.0 9.25	111.3 4.38	99.1 3.90	M16 x 121 —	4.0 8.8	4.9 10.8
<b>150 x 65</b> 165.1mm x 76.1mm	69.9 2.75	73.0 2.88	15.7 3534.3	130.3 5.13	235.0 9.25	111.3 4.38	99.1 3.90	M16 x 121 —	4.0 8.8	4.9 10.8
<b>150 x 80</b> 165.1mm x 3	88.9 3.50	92.1 3.63	21.4 4810.6	139.7 5.50	235.0 9.25	130.3 5.13	99.1 3.90	M16 x 121 —	4.6 10.1	6.0 13.3
<b>150 x 100</b> 165.1mm x 4	114.3 4.50	117.5 4.63	35.4 7952.2	136.7 5.38	235.0 9.25	155.7 6.13	99.1 3.90	M16 x 121 —	5.3 11.6	7.4 16.3
<b>150 x 32</b> 6 x 1¼	50.8 2.00	54.0 2.13	4.8 1082.1	130.3 5.13	235.0 9.25	90.4 3.56	99.1 3.90	M16 x 121 ⅝ x 4¾	3.5 7.7	4.3 9.5
<b>150 x 40</b> 6 x 1½	50.8 2.00	54.0 2.13	6.3 1417.6	130.3 5.13	235.0 9.25	90.4 3.56	99.1 3.90	M16 x 121 ⅝ x 4¾	3.4 7.6	4.2 9.3



## Figure 730 Mechanical Tees & Crosses – Grooved

(Page 3 of 3)

Tech Data Sheet: TFP1860

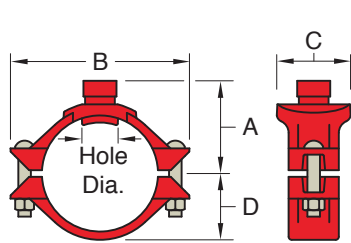

Figure 730 Branch Outlet with Grooved Branch (Tee Configuration)

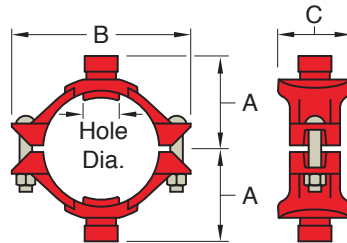

Figure 730 Branch Outlet with Grooved Branch (Cross Configuration)

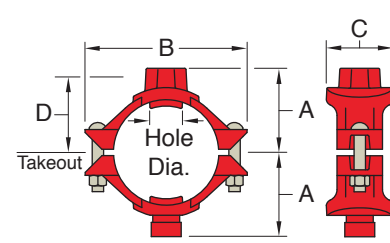

Figure 730 Branch Outlet with a Female NPT/BSP Threaded Branch and a Grooved Branch (Cross Configuration)

Nominal Size Run x Branch mm Inches	Hole Dia. †		Max. ‡ End Load Branch kN Lbs.	Dimensions - mm Inches				Bolt Size mm Inches	Tee Approx. Weight kg Lbs.	Cross Approx. Weight kg Lbs.
	Min. mm Inches	Max. mm Inches		A	B	C	D			
<b>150 x 50</b>	<b>63.5</b>	<b>66.7</b>	<b>9.9</b>	<b>130.3</b>	<b>235.0</b>	<b>103.1</b>	<b>99.1</b>	<b>M16 x 121</b>	<b>3.6</b>	<b>4.1</b>
6 x 2	2.50	2.63	2215.1	5.13	9.25	4.06	3.90	5/8 x 4-3/4	8.0	9.1
<b>150 x 65</b>	<b>69.9</b>	<b>73.0</b>	<b>14.4</b>	<b>130.3</b>	<b>235.0</b>	<b>111.3</b>	<b>99.1</b>	<b>M16 x 121</b>	<b>4.0</b>	<b>4.9</b>
6 x 2-1/2	2.75	2.88	3245.9	5.13	9.25	4.38	3.90	5/8 x 4-3/4	8.8	10.8
<b>150 x 65</b>	<b>69.9</b>	<b>73.0</b>	<b>14.4</b>	<b>130.3</b>	<b>235.0</b>	<b>111.3</b>	<b>99.1</b>	<b>M16 x 121</b>	<b>4.0</b>	<b>4.9</b>
6 x 76.1mm	2.75	2.88	3245.9	5.13	9.25	4.38	3.90	5/8 x 4-3/4	8.8	10.8
<b>150 x 80</b>	<b>88.9</b>	<b>92.1</b>	<b>21.4</b>	<b>139.7</b>	<b>235.0</b>	<b>130.3</b>	<b>99.1</b>	<b>M16 x 121</b>	<b>4.6</b>	<b>6.0</b>
6 x 3	3.50	3.63	4810.6	5.50	9.25	5.13	3.90	5/8 x 4-3/4	10.1	13.3
<b>150 x 100</b>	<b>114.3</b>	<b>117.5</b>	<b>35.4</b>	<b>136.7</b>	<b>235.0</b>	<b>155.7</b>	<b>99.1</b>	<b>M16 x 121</b>	<b>5.3</b>	<b>7.4</b>
6 x 4	4.50	4.63	7952.2	5.38	9.25	6.13	3.90	5/8 x 4-3/4	11.6	16.3
<b>200 x 65</b>	<b>69.9</b>	<b>73.0</b>	<b>14.4</b>	<b>158.8</b>	<b>317.5</b>	<b>111.3</b>	<b>124.5</b>	<b>M20 x 121</b>	<b>5.6</b>	<b>6.6</b>
8 x 2-1/2	2.75	2.88	3245.9	6.25	12.50	4.38	4.90	3/4 x 4-3/4	12.3	14.5
<b>200 x 65</b>	<b>69.9</b>	<b>73.0</b>	<b>15.7</b>	<b>158.8</b>	<b>317.5</b>	<b>111.3</b>	<b>124.5</b>	<b>M20 x 121</b>	<b>5.6</b>	<b>6.6</b>
8 x 76.1mm	2.75	2.88	3534.3	6.25	12.50	4.38	4.90	-	12.3	14.5
<b>200 x 80</b>	<b>88.9</b>	<b>92.1</b>	<b>21.4</b>	<b>165.1</b>	<b>317.5</b>	<b>130.3</b>	<b>124.5</b>	<b>M20 x 121</b>	<b>6.0</b>	<b>7.3</b>
8 x 3	3.50	3.63	4810.6	6.50	12.50	5.13	4.90	3/4 x 4-3/4	13.2	16.1
<b>200 x 100</b>	<b>114.3</b>	<b>117.5</b>	<b>35.4</b>	<b>162.1</b>	<b>317.5</b>	<b>155.7</b>	<b>124.5</b>	<b>M20 x 121</b>	<b>6.7</b>	<b>8.6</b>
8 x 4	4.50	4.63	7952.2	6.38	12.50	6.13	4.90	3/4 x 4-3/4	14.7	19.0

◆ Contact GRINNELL for dimension details.

† Proper hole preparation is required for effective sealing and performance. Check the pipe seal surface within 15.9mm (5/8") of the hole to ensure it is free from conditions affecting proper gasket sealing. Remove any sharp or rough edges from the hole or upper housing contact area that might affect assembly, proper seating of the locating collar, or flow from the outlet. For crosses, ensure double outlet holes are aligned on opposite sides of the pipe.

‡ Maximum pressures and end loads are total from all loads based on standard weight steel pipe. Pressure ratings and end loads may differ on other pipe materials and/or wall thickness. Contact GRINNELL Products for details.

For information on larger sizes, Chinese sizes or other alternative sizes, contact GRINNELL Products.

See page 50 for mechanical tee specifications, and see pages 76 - 78 for gasket information.













Outlet  
Fittings

Outlet  
Fittings



# VALVES

## Valves Pictorial Table of Contents

	<p><b>Model CV-1F</b> Grooved Check Valves Page – 61</p>		<p><b>Model TMRG</b> Resilient-Seated Gate Valves, OS&amp;Y, Groove x Groove Pages – 67, 69</p>
	<p><b>Model CV-1FR</b> Grooved Shotgun Riser Check Valves Pages – 62 - 63</p>		<p><b>Model TMCX-P</b> Resilient-Seated Gate Valves, NRS, Flange x Flange , ANSI Class #125, PN10 &amp; PN16 Pages – 70 - 71</p>
	<p><b>Model BFV-N</b> <b>Butterfly Valves</b> Groove x Groove Page – 64</p>		<p><b>Model TMCT-P</b> Resilient-Seated Gate Valves, NRS, Flange x Groove Pages – 70, 72</p>
	<p><b>Model BFV-N</b> <b>Butterfly Valves</b> Wafer Style Page – 65</p>		<p><b>Model TMCG-P</b> Resilient-Seated Gate Valves, NRS, Groove x Groove Pages – 70, 72</p>
	<p><b>Model BFV-N</b> <b>Butterfly Valves</b> Lug Style Page – 66</p>		<p><b>Model POST-IND</b> Indicator Post, Adjustable Pages – 70, 73</p>
	<p><b>Model TMRX</b> Resilient-Seated Gate Valves, OS&amp;Y, Flange x Flange , ANSI Class #125, PN10 &amp; PN16 Pages – 67 - 68</p>		<p><b>Model WALL-IND</b> Indicator Post Wall Type Pages – 70, 74</p>
	<p><b>Model TMRT</b> Resilient-Seated Gate Valves, OS&amp;Y, Flange x Groove Pages – 67, 69</p>		

Valves

## Model CV-1F G-FIRE Grooved Check Valves

Tech Data Sheet: TFP1550



The TYCO Model CV-1F Check Valve is a compact and rugged swing-type unit that allows water flow in one direction and prevents flow in the opposite direction. A resilient elastomer seal facing on the spring-loaded clapper ensures a leak-tight seal and non-sticking operation. The Model CV-1F Check Valves are designed to minimize water hammer caused by flow reversal.



For Fire Protection Pressure Rating and Listing / Approval information contact GRINNELL Products.

### SPECIFICATIONS

#### Valve Assembly Finish

- Red, non-lead paint

#### Max Working Pressure

- 20,7 bar (300 psi)

#### Body

- Ductile iron

#### Clapper

- 50 - 200mm - Stainless Steel,  
250 - 300mm - Ductile iron

#### Clapper Facing

- Grade "E" EPDM encapsulated rubber

#### Performance

- Contact GRINNELL Products.

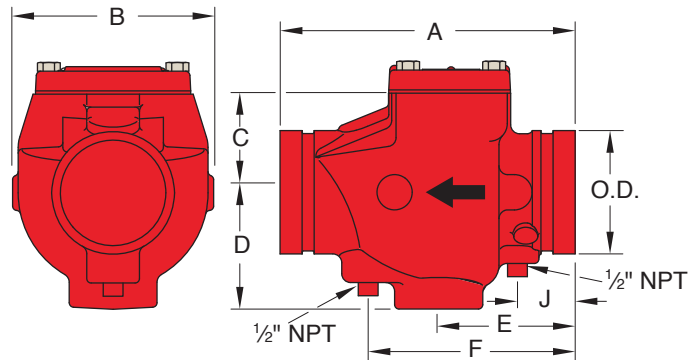

Pipe Size		Dimensions mm Inches							Approx. Weight kg Lbs
Nominal mm Inches	O.D. mm Inches	A mm Inches	B mm Inches	C mm Inches	D mm Inches	E mm Inches	F mm Inches	J mm Inches	
50 2	60,3 2.375	171,5 6.75	111,3 4.38	49,8 1.96	65,3 2.57	82,3 3.25	120,7 4.75	41,5 1.62	4,5 9,0
65 2-1/2	73,0 2.875	203,2 8.00	136,7 5.38	66,7 2.63	78,5 3.09	98,3 3.87	149,1 5.87	41,7 1.64	4,5 10,0
65 76.1mm	76,1 3.000	203,2 8.00	136,7 5.38	66,7 2.63	78,5 3.09	98,3 3.87	149,1 5.87	41,7 1.64	4,5 10,0
80 3	88,9 3.500	212,6 8.37	145,3 5.72	71,4 2.81	84,1 3.31	98,3 3.87	149,1 5.87	41,7 1.64	5,0 11,0
100 4	114,3 4.500	244,6 9.63	169,7 6.68	96,5 3.80	92,2 3.63	115,4 4.53	181,1 7.13	46,7 1.84	11,3 25,0
125 139.7mm	139,7 5.500	266,7 10.50	188,0 7.40	113,3 4.46	104,9 4.13	124,5 4.90	190,5 7.50	44,5 1.75	13,2 29,0
125 5	141,3 5.563	266,7 10.50	188,0 7.40	113,3 4.46	104,9 4.13	124,5 4.90	190,5 7.50	44,5 1.75	13,2 29,0
150 165.1mm	165,1 6.500	292,1 11.50	203,2 8.00	117,3 4.62	114,3 4.50	127,0 5.00	193,0 7.60	47,0 1.85	21,3 47,0
150 6	168,3 6.625	292,1 11.50	203,2 8.00	117,3 4.62	114,3 4.50	127,0 5.00	193,0 7.60	47,0 1.85	21,3 47,0
200 8	219,1 8.625	355,6 14.00	257,8 10.15	169,4 6.67	140,2 5.52	138,7 5.46	214,9 8.46	54,1 2.13	29,9 66,0
250 10	273,0 10.750	457,2 18.00	314,5 12.38	218,9 8.62	162,8 6.41	190,5 7.50	266,7 10.50	76,2 3.00	49,4 109,7
300 12	323,9 12.750	533,4 21.00	362,7 14.28	252,2 9.93	184,7 7.27	193,5 7.62	269,7 10.62	69,9 2.75	68,0 151,0

Refer to back cover for country-specific contact information.

## Model CV-1FR G-FIRE Grooved Shotgun Riser Check Valves

(Page 1 of 2)

Tech Data Sheet: TFP950



For Fire Protection Pressure Rating and Listing / Approval information contact GRINNELL Products.

The TYCO Model CV-1FR Riser Check Valve is a compact and rugged swingtype unit that allows water flow in one direction and prevents flow in the opposite direction. A resilient elastomer seal facing on the spring-loaded clapper ensures a leak-tight seal and nonsticking operation. The Model CV-1FR Check Valves are designed to minimize water hammer caused by flow reversal.

### SPECIFICATIONS

#### Valve Assembly Finish

- Red, non-lead paint

#### Max Working Pressure

- 20,7 bar (300 psi)

#### Body

- Ductile iron

#### Clapper

- 50 - 200mm - Stainless Steel,  
250 - 300mm - Ductile iron

#### Clapper Facing

- Grade "E" EPDM encapsulated rubber

#### Performance

- Contact GRINNELL Products.

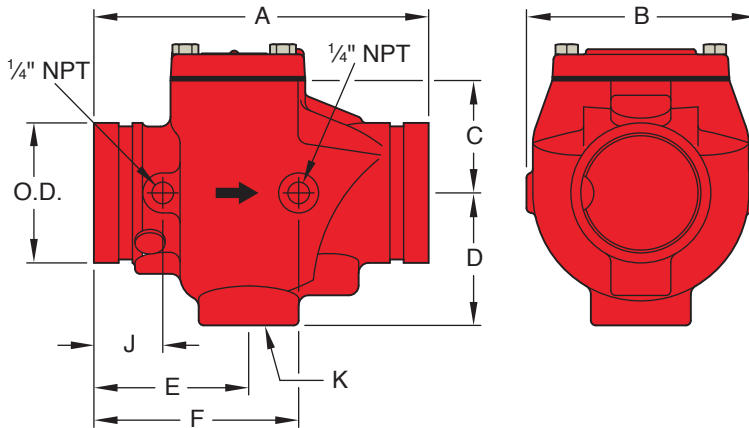

Valves

Pipe Size		A mm Inches	B mm Inches	C mm Inches	D mm Inches	E mm Inches	F mm Inches	J mm Inches	K NPT mm Inches	Cover Bolt Torq. Lbs.-ft. (Nm)	Approx. Weight kg Lbs.
Nominal mm Inches	O.D. mm Inches										
50 2	60,3 2.375	171,5 6.75	111,3 4.38	64,8 2.55	65,3 2.57	82,3 3.25	21 15	4,5 9.0	1	25 18	4,5 9.0
65 2-1/2	73,0 2.875	203,2 8.00	136,7 5.42	86,6 3.41	78,5 3.09	98,6 3.88	54 39	4,5 10.0	1 1/4	54 39	4,5 10.0
65 76.1mm	76,1 3.000	203,2 8.00	136,7 5.42	86,6 3.41	78,5 3.09	98,6 3.88	54 39	4,5 10.0	1 1/4	54 39	4,5 10.0
80 3	88,9 3.500	212,9 8.38	146,3 5.76	91,4 3.60	84,1 3.31	98,6 3.88	54 39	5,0 11.0	1 1/4	54 39	5,0 11.0
100 4	114,3 4.500	245,6 9.63	171,2 6.74	117,1 4.61	92,2 3.63	115,4 4.53	54 39	11,3 25.0	2	69 50	11,3 25.0
125 139.7mm	139,7 5.500	266,7 10.50	190,5 7.50	134,4 5.29	104,9 4.13	124,5 4.90	54 39	13,2 29.0	2	54 39	13,2 29.0
125 5	141,3 5.563	266,7 10.50	190,5 7.50	134,4 5.29	104,9 4.13	124,5 4.90	54 39	13,2 29.0	2	54 39	13,2 29.0
150 165.1mm	165,1 6.500	292,1 11.50	204,4 8.05	146,1 5.75	114,3 4.50	127,0 5.00	82 60	21,3 47.0	2	82 60	21,3 47.0
150 6	168,3 6.625	292,1 11.50	204,4 8.05	146,1 5.75	114,3 4.50	127,0 5.00	82 60	21,3 47.0	2	82 60	21,3 47.0
200 8	219,1 8.625	355,6 14.00	260,4 10.25	196,9 7.75	142,7 5.62	138,4 5.45	164 120	30,0 66.0	2	164 120	30,0 66.0
250 10	273,1 10.750	457,2 18.00	330,2 13.00	259,3 10.21	162,1 6.38	190,5 7.50	164 120	49,4 109.7	2	178 130	49,4 109.7

# Model CV-1FR G-FIRE Grooved Shotgun Riser Check Valves

(Page 2 of 2)

Tech Data Sheet: TFP950

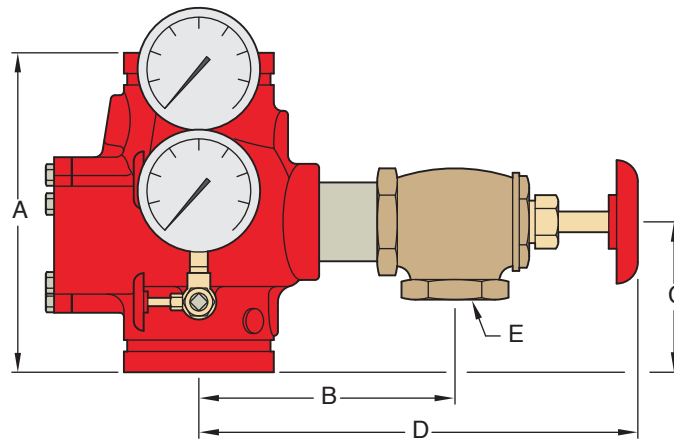

Pipe Size		Dimensions mm Inches				
Nominal mm Inches	O.D. mm Inches	A mm Inches	B mm Inches	C mm Inches	D mm Inches	E mm Inches
50 2	60,3 2.375	171,5 6.75	165,1 6.50	82,6 3.25	257,2 10.13	0,04 1
65 2-1/2	73,0 2.875	203,2 8.00	166,7 6.56	98,6 3.88	282,6 11.13	0,05 1 1/4
65 76.1mm	76,1 3.000	203,2 8.00	166,7 6.56	98,6 3.88	282,6 11.13	0,05 1 1/4
80 3	88,9 3.500	212,6 8.37	173,0 6.81	98,6 3.88	282,6 11.13	0,05 1 1/4
100 4	114,3 4.500	244,6 9.63	196,9 7.75	98,6 3.88	336,6 13.25	0,08 2
125 139.7mm	139,7 5.500	266,7 10.50	209,6 8.25	127,0 5.00	350,8 13.81	0,08 2
125 5	141,3 5.563	266,7 10.50	209,6 8.25	127,0 5.00	350,8 13.81	0,08 2
150 165.1mm	165,1 6.500	292,1 11.50	217,5 8.56	127,0 5.00	358,8 14.13	0,08 2
150 6	168,3 6.625	292,1 11.50	217,5 8.56	127,0 5.00	358,8 14.13	0,08 2
200 8	219,1 8.625	355,6 14.00	247,7 9.75	139,7 5.50	387,4 15.25	0,08 2
250 10	273,1 10.750	457,2 18.00	271,8 10.70	190,5 7.50	412,8 16.25	0,08 2

Valves

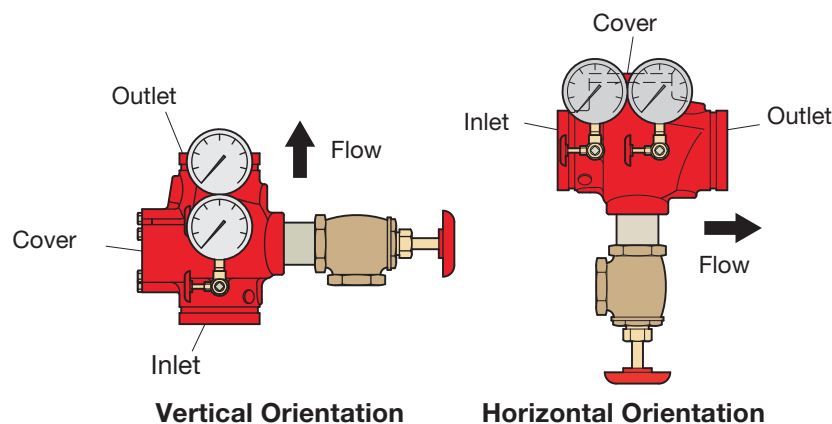

## Model BFV-N G-FIRE Butterfly Valves – Groove x Groove

Tech Data Sheet: TFP1510

**10**  
YEAR  
LIMITED  
WARRANTY



The Model BFV-N Grooved End Butterfly Valves are indicating type valves designed for use in fire protection systems where a visual indication is required as to whether the valve is open or closed. They are used, for example, as system, sectional, and pump water control valves. They have cut groove inlet and outlet connections that are suitable for use with grooved end pipe couplings that are listed and approved for fire protection systems.



For Fire Protection Pressure Rating and Listing / Approval information contact GRINNELL Products.

### SPECIFICATIONS

#### Max Working Pressure

- 65 - 200mm (2-1/2" - 8"): 20,7 bar (300 psi)
- 250mm (10"): 12,0 bar (175 psi)

#### Body & Disc

- Ductile iron conforming to ASTM A 395

#### Body Coating

- Polyamide

#### Disc Seal

- Grade EPDM "E" encapsulated rubber conforming to ASTM D-2000

#### Upper & Lower Stem

- Type 416 Stainless Steel conforming to ASTM 582

#### Operator

- Gear operator with iron housing

#### Performance

- Contact GRINNELL Products.

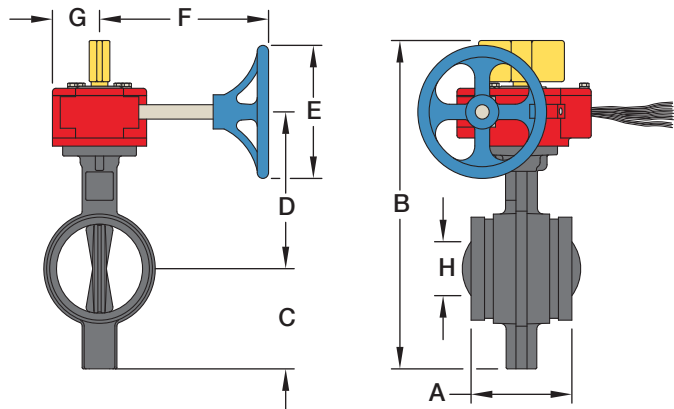

Valves

Pipe Size		Installation Dimensions mm Inches								Weight kg Lbs.
Nominal mm Inches	O.D. mm Inches	A mm Inches	B mm Inches	C mm Inches	D mm Inches	E mm Inches	F mm Inches	G mm Inches	H mm Inches	
65 2-1/2	73,0 2.88	98,0 3.85	303,3 11.94	83,0 3.25	144,0 5.67	149,9 5.90	147,8 5.82	54,1 2.13	0 0	10,0 22
80 3	88,9 3.50	98,0 3.85	317,0 12.48	90,0 3.54	150,9 5.94	149,9 5.90	147,8 5.82	54,1 2.13	0 0	10,4 23
100 4	114,3 4.50	116,0 4.56	360,2 14.18	110,0 4.35	160,3 6.31	149,9 5.90	194,1 7.64	54,1 2.13	0 0	12,7 28
125 5	141,3 5.56	149,0 5.86	385,3 15.17	123,0 4.84	185,9 7.32	149,9 5.90	194,1 7.64	54,1 2.13	0 0	14,1 31
150 6	168,3 6.63	149,0 5.86	445,5 17.54	151,0 5.93	218,9 8.62	149,9 5.90	194,1 7.64	54,1 2.13	17,0 0.67	18,6 41
200 8	219,1 8.63	134,0 5.26	493,3 19.42	174,0 6.87	248,9 9.80	248,9 9.80	200,9 7.91	54,1 2.13	148,8 5.86	24,1 53
250 10	273,1 10.75	160,0 6.29	610,4 24.03	233,0 9.17	294,9 11.61	457,2 18.00	241,0 9.49	77,0 3.03	188,2 7.41	40,0 88



## Model BFV-N G-FIRE Butterfly Valves – Wafer Style

Tech Data Sheet: TFP1515



The Model BFV-N Wafer Style Butterfly Valves are indicating type valves designed for use in fire protection systems where a visual indication is required as to whether the valve is open or closed. They are used, for example, as system, sectional, and pump water control valves. They are suitable for installation between ANSI Class 125 or 150 flanges without the need for flange gaskets.

### SPECIFICATIONS

#### Max Working Pressure

- 17,2 bar (250 psi)

#### Body

- Ductile iron conforming to ASTM A-536

#### Disc

- Ductile iron conforming to ASTM A-395, Nickel Plated

#### Seat Material

- Grade EPDM “E” encapsulated rubber conforming to ASTM D-2000

#### Upper Stem

- Type 416 Stainless Steel conforming to ASTM 582

#### Operator

- Gear operator with iron housing

#### Performance

- Contact GRINNELL Products.

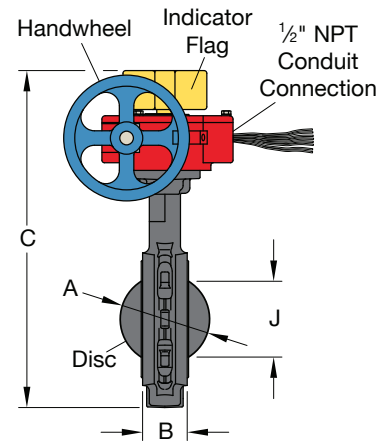
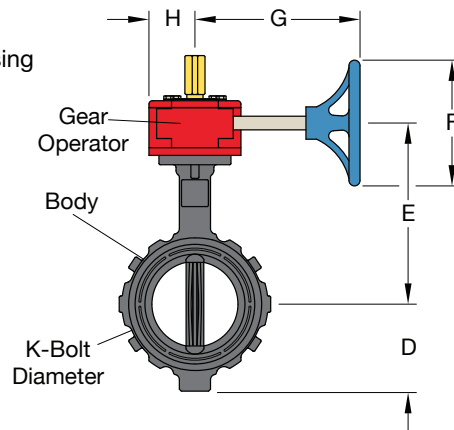

For Fire Protection Pressure Rating and Listing / Approval information contact GRINNELL Products.

Pipe Size		Installation Dimensions mm Inches										Weight kg Lbs.
Nominal mm Inches	O.D. mm Inches	A mm Inches	B mm Inches	C mm Inches	D mm Inches	E mm Inches	F mm Inches	G mm Inches	H mm Inches	J mm Inches	K mm Inches	
50 2	60,3 2.375	64,0 2.53	43,0 1.68	320,5 12.62	73,0 2.88	164,6 6.48	152,4 6.00	147,3 5.80	53,8 2.12	35,1 1.38	15,9 5/8	10,0 21
65 2½	73,0 2.875	74,0 2.90	46,0 1.81	343,1 13.51	83,0 3.25	177,3 6.98	152,4 6.00	147,3 5.80	53,8 2.12	50,8 2.00	15,9 5/8	11,0 24
80 3	88,9 3.500	81,0 3.17	46,0 1.81	352,6 13.88	86,0 3.38	183,4 7.22	152,4 6.00	147,3 5.80	53,8 2.12	64,8 2.55	15,9 5/8	11,0 24
100 4	114,3 4.500	106,0 4.17	52,0 2.06	387,0 15.24	102,0 4.00	202,7 7.98	152,4 6.00	147,3 5.80	53,8 2.12	65,5 2.58	15,9 5/8	12,0 27
125 5	141,3 5.563	131,0 5.17	56,0 2.19	418,8 16.49	121,0 4.75	215,4 8.48	152,4 6.00	198,1 7.80	53,8 2.12	117,9 4.64	19,1 3/4	14,0 31
150 6	168,3 6.625	157,0 6.17	56,0 2.19	448,3 17.65	133,0 5.25	231,1 9.10	152,4 6.00	198,1 7.80	53,8 2.12	146,1 5.75	19,1 3/4	15,0 34
200 8	219,1 8.625	208,0 8.17	60,0 2.38	510,8 20.11	165,0 6.50	262,9 10.35	254,0 10.00	200,7 7.90	53,8 2.12	197,4 7.77	19,1 3/4	22,0 49
250 10	273,1 10.750	258,0 10.17	69,0 2.68	593,1 23.35	203,0 8.00	311,7 12.27	300,0 11.80	241,3 9.50	77,0 3.03	248,2 9.77	22,2 7/8	35,0 78
300 12	323,9 12.750	309,0 12.17	76,0 3.00	663,0 26.10	235,0 9.25	349,8 13.77	300,0 11.80	241,3 9.50	77,0 3.03	298,5 11.75	22,2 7/8	47,0 103

Refer to back cover for country-specific contact information.

## Model BFV-N G-FIRE Butterfly Valves – Lug Style

Tech Data Sheet: TFP1520

**10**  
YEAR  
LIMITED  
WARRANTY

The Model BFV-N Lug Style Butterfly Valves are indicating type valves designed for use in fire protection systems where a visual indication is required as to whether the valve is open or closed. They are used, for example, as system, sectional, and pump water control valves. They are suitable for installation between ANSI Class 125 or 150 flanges without the need for flange gaskets.

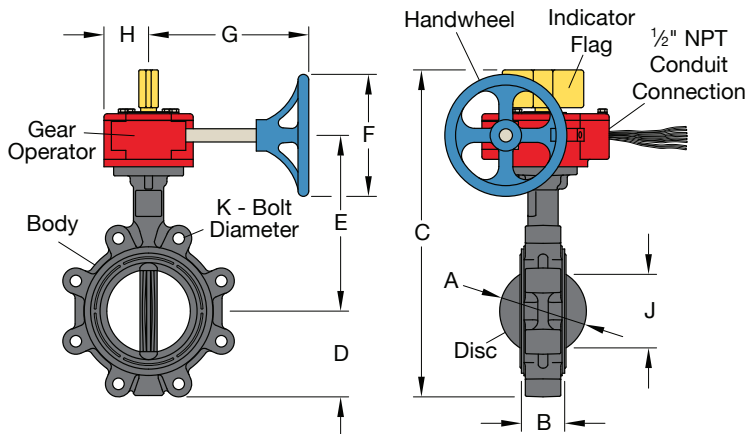

For Fire Protection Pressure Rating and Listing / Approval information contact GRINNELL Products.

### SPECIFICATIONS

#### Max Working Pressure

- 17,2 bar (250 psi)

#### Body

- Ductile iron conforming to ASTM A-536

#### Disc

- Ductile iron conforming to ASTM A-395, Nickel Plated

#### Seat Material

- Grade EPDM "E" encapsulated rubber conforming to ASTM D-2000

#### Upper Stem

- Type 416 Stainless Steel conforming to ASTM 582

#### Operator

- Gear operator with iron housing

#### Performance

- Contact GRINNELL Products.

Valves

Pipe Size		Installation Dimensions mm Inches										Weight kg Lbs.
Nominal mm Inches	O.D. mm Inches	A mm Inches	B mm Inches	C mm Inches	D mm Inches	E mm Inches	F mm Inches	G mm Inches	H mm Inches	J mm Inches	K mm Inches	
50	60,3	64,0	43,0	320,5	73,0	164,6	152,4	147,3	53,8	35,1	15,9	10,0
2	2.375	2.53	1.68	12.62	2.88	6.48	6.00	5.80	2.12	1.38	5/8	21
65	73,0	74,0	46,0	343,1	83,0	177,3	152,4	147,3	53,8	50,8	15,9	11,0
2-1/2	2.875	2.90	1.81	13.51	3.25	6.98	6.00	5.80	2.12	2.00	5/8	24
80	88,9	81,0	46,0	352,6	86,0	183,4	152,4	147,3	53,8	64,8	15,9	11,0
3	3.500	3.17	1.81	13.88	3.38	7.22	6.00	5.80	2.12	2.55	5/8	24
100	114,3	106,0	52,0	387,0	102,0	202,7	152,4	147,3	53,8	65,5	15,9	12,0
4	4.500	4.17	2.06	15.24	4.00	7.98	6.00	5.80	2.12	2.58	5/8	27
125	141,3	131,0	56,0	418,8	121,0	215,4	152,4	198,1	53,8	117,9	19,1	14,0
5	5.563	5.17	2.19	16.49	4.75	8.48	6.00	7.80	2.12	4.64	3/4	31
150	168,3	157,0	56,0	448,3	133,0	231,1	152,4	198,1	53,8	146,1	19,1	15,0
6	6.625	6.17	2.19	17.65	5.25	9.10	6.00	7.80	2.12	5.75	3/4	34
200	219,1	208,0	60,0	510,8	165,0	262,9	254,0	200,7	53,8	197,4	19,1	22,0
8	8.625	8.17	2.38	20.11	6.50	10.35	10.00	7.90	2.12	7.77	3/4	49
250	273,1	258,0	69,0	593,1	203,0	311,7	300,0	241,3	77,0	248,2	22,2	35,0
10	10.750	10.17	2.68	23.35	8.00	12.27	11.80	9.50	3.03	9.77	7/8	78
300	323,9	309,0	76,0	663,0	235,0	349,8	300,0	241,3	77,0	298,5	22,2	47,0
12	12.750	12.17	3.00	26.10	9.25	13.77	11.80	9.50	3.03	11.75	7/8	103

See Flange Drilling Specifications on page 96.

## Model TMR Resilient-Seated Gate Valves Outside Screw & Yoke (OS&Y)

(Page 1 of 3)

Tech Data Sheet: TFP1540



TYCO Resilient-Seated Gate Valves are used in Fire Protection Systems for on/off operation. End connection configurations including Flange by Flange, Flange by Groove, and Groove by Groove are available.

The ductile Iron body weighs approximately 50% less than conventional cast iron valves, which allows easier handling on site and reduced shipping costs.

The fully encapsulated EPDM ductile iron wedge ensures drop-tight sealing.

Valve components are either inherently corrosion-resistant or protected with fusion-bonded epoxy resin coating for a long, reliable service life and enhanced UV protection in exposed installations.

This valve is one of the lightest, most durable gate valves on the market today. Its design features and material selection criteria fulfill the need for a reliable, long life and easy to operate gate valve.



### SPECIFICATIONS

#### Max Working Pressure

FM - 16.0 bar (232 psi)

UL - 20.8 bar (300 psi)

#### Flanges

- ASME B16.1/ASME B16.42 EN 1092-2/ISO 7005-2 Drilled to ANSI 125/150, PN10/PN16, or Table E BS10

#### Performance

- Contact GRINNELL Products.



For additional listings or approvals, see page 8 or visit our website at [www.grinnell.com](http://www.grinnell.com)

Valves

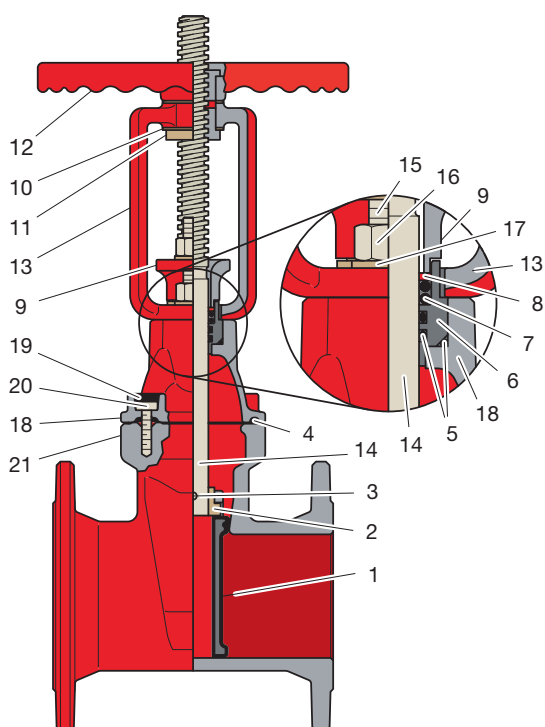

Valve Material Specifications			
Item No.	Description	Qty	Material
1	Wedge	1	EPDM Coated Ductile Iron
2	Wedge Nut	1	Bronze
3	Stem Pin	2	Stainless Steel
4	Sealing Gasket	1	EPDM
5	Sealing O-Ring	3	NBR
6	Stem Guide	1	Bronze
7	Stem O-Ring	2	NBR
8	Compression Washer	1	Stainless Steel
9	Top Gland	1	FBE Coated Ductile Iron
10	Washers	2	Bronze
11	Top Nut	2	Bronze
12	Handwheel	1	FBE Coated Ductile Iron
13	Yoke	1	FBE Coated Ductile Iron
14	Stem	1	Stainless
15	Gland Stud	2	Zinc Coated Carbon Steel
16	Gland Hex Nut	4	Zinc Coated Carbon Steel
17	Gland Washer	4	Zinc Coated Carbon Steel
18	Bonnet	1	FBE Coated Ductile Iron
19	Screw Grouting	1	Activated Resin
20	Bonnet Screw	4	Black Oxide Carbon Steel
21	Body	1	FBE Coated Ductile Iron

Refer to back cover for country-specific contact information.

## Model TMRX Resilient-Seated Gate Valves Outside Screw & Yoke Flange x Flange, ANSI Class #125, PN10 & PN16

(Page 2 of 3)

Tech Data Sheet: TFP1540

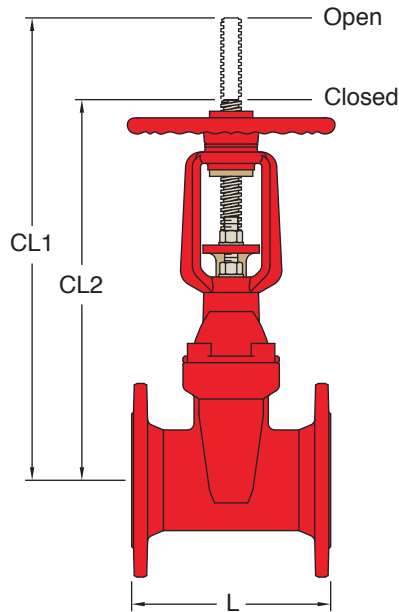

Valve Size		Dimensions mm Inches			Turns to Open	Approx. Weight kg Lbs
Nominal mm Inches	O.D. mm Inches	L mm Inches	CL1 mm Inches	CL2 mm Inches		
50 2	60.3 2.375	178 7.00	395 15.55	332 13.07	13	13.5 29.8
65 2½	73.0 2.875	190 7.50	410 16.14	338 13.31		16
80 3	88.9 3.500	203 8.00	480 18.90	380 14.96	20	19.0 41.9
100 4	114.3 4.500	229 9.00	573 22.56	450 17.72		20
150 6	168.3 6.625	267 10.50	750 29.53	592 23.31	25	44.0 97.0
200 8	219.1 8.625	292 11.50	956 37.64	748 29.45		34
250 10	273.1 10.750	330 13.00	1175 46.26	888 34.96	42	120.0 264.4
300 12	323.9 12.750	356 14.00	1318 51.89	1005 39.57		50

See Valve Specifications on page 67

Valves

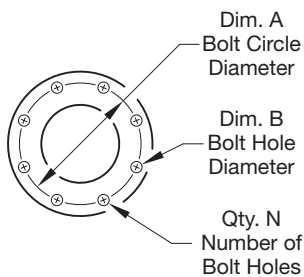

Gate Valve Flange Nominal Dimensions										
Valve Size		ANSI Class 150			ISO 7005-2 PN16			Table E (BS10)		
Nominal mm Inches	O.D. mm Inches	A mm Inches	B mm Inches	Qty. N	A mm Inches	B mm Inches	Qty. N	A mm Inches	B mm Inches	Qty. N
50 2	60.3 2.375	120.5 4.75	19 0.75	4	125.0 4.92	19 0.75	4	114.0 4.49	18 0.71	4
65 2½	73.0 2.875	139.5 5.50	19 0.75	4	145.0 5.71	19 0.75	4	127.0 5.00	18 0.71	4
80 3	88.9 3.500	152.5 6.00	19 0.75	4	160.0 6.30	19 0.75	8	146.0 5.75	18 0.71	4
100 4	114.3 4.500	190.5 7.50	19 0.75	8	180.0 7.09	19 0.75	8	178.0 7.00	18.0 0.71	8
150 6	168.3 6.625	241.5 9.50	22 0.88	8	240.0 9.45	22 0.88	8	235.0 9.25	22.0 0.87	8
200 8	219.1 8.625	298.5 11.75	22 0.88	8	295.0 11.61	22 0.88	12	292.0 11.50	22.0 0.87	8
250 10	273.1 10.750	362.0 14.25	25 1.00	12	355.0 13.98	28 1.13	12	365.0 14.37	22.0 0.87	12
300 12	323.9 12.750	432.0 17.00	25 1.00	12	410.0 16.14	28 1.13	12	406.0 15.98	26.0 1.02	12

## Model TMRT Resilient-Seated Gate Valves Outside Screw & Yoke Flange x Groove, ANSI Class #125, PN10 & PN16

(Page 3 of 3)

Tech Data Sheet: TFP1540



Valve Size		Dimensions mm Inches			Turns to Open	Approx. Weight kg Lbs
Nominal mm Inches	O.D. mm Inches	L mm Inches	CL1 mm Inches	CL2 mm Inches		
50	60.3	178	395	332	13	12.5
2	2.375	7.00	15.55	13.07		27.6
65	73.0	190	410	338	16	14.0
2-1/2	2.875	7.50	16.14	13.31		30.9
65	76.1	190	410	338	16	14.0
76.1mm	3.000	7.48	16.14	13.31		30.9
80	88.9	203	480	380	20	16.5
3	3.500	8.00	18.90	14.96		36.4
100	114.3	229	573	450	20	23.0
4	4.500	9.00	22.56	17.72		50.7
150	165.1	267	750	592	25	40.0
165.1mm	6.500	10.51	29.53	23.31		88.2
150	168.3	267	750	592	25	40.0
6	6.625	10.50	29.53	23.31		88.2
200	219.1	292	956	748	34	65.0
8	8.625	11.50	37.64	29.45		143.3
250	273.1	330	1175	888	42	110.0
10	10.750	13.00	46.26	34.96		242.6
300	323.9	356	1318	1005	50	135.0
12	12.750	14.00	51.89	39.57		297.7

See Valve Specifications on page 67  
See Valve Flange dimensions on prior page

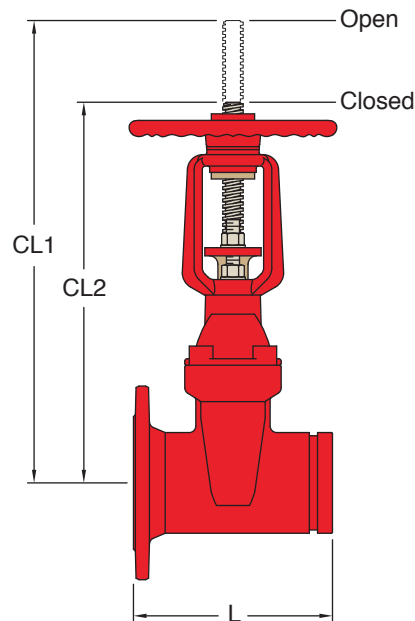

## Model TMRG Resilient-Seated Gate Valves Outside Screw & Yoke Groove x Groove

Valves

(Page 3 of 3)

Tech Data Sheet: TFP1540



Valve Size		Dimensions mm Inches			Turns to open	Approx. Weight kg Lbs
Nominal mm Inches	O.D. mm Inches	L mm Inches	CL1 mm Inches	CL2 mm Inches		
50	60.3	178	395	332	13	11.5
2	2.375	7.00	15.55	13.07		25.4
65	73.0	190	410	338	16	12.0
2-1/2	2.875	7.50	16.14	13.31		26.5
65	76.1	190	410	338	16	12.0
76.1mm	3.000	7.48	16.14	13.31		26.5
80	88.9	203	480	380	20	14.0
3	3.500	8.00	18.90	14.96		30.9
100	114.3	229	573	450	20	20.0
4	4.500	9.00	22.56	17.72		44.1
150	165.1	267	750	592	25	36.0
165.1mm	6.500	10.51	29.53	23.31		79.4
150	168.3	267	750	592	25	36.0
6	6.625	10.50	29.53	23.31		79.4
200	219.1	292	956	748	34	50.0
8	8.625	11.50	37.64	29.45		110.3
250	273.1	330	1175	888	42	100.0
10	10.750	13.00	46.26	34.96		220.5
300	323.9	356	1318	1005	50	125.0
12	12.750	14.00	51.89	39.57		275.6

See Valve Specifications on page 67

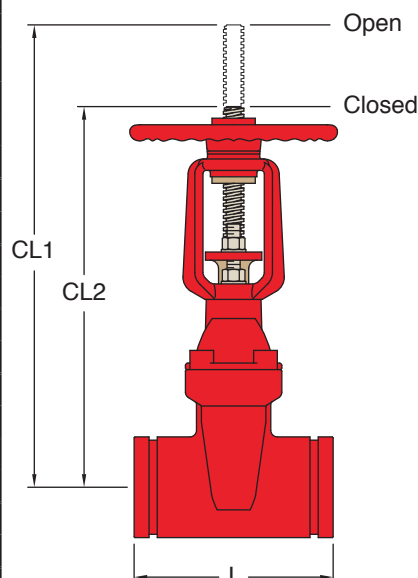

## Model TMCXP Non Rising Stem Resilient-Seated Gate Valves

(Page 1 of 5)

Tech Data Sheet: TFP1545



TYCO Resilient-Seated Gate Valves with Vertical and Cross Wall Indicators are used in fire protection systems for on/off operation. End connection configurations including Flange by Flange, Flange by Groove, and Groove by Groove are available.

The ductile iron body weighs approximately 50% less than conventional cast iron valves, which allows easier handling on site and reduced shipping costs.

The fully encapsulated EPDM ductile iron wedge ensures drop-tight sealing.

Valve components are either inherently corrosion-resistant or protected with fusion-bonded epoxy resin coating for a long, reliable service life and enhanced UV protection in exposed installations.

This valve is one of the lightest, most durable gate valves on the market today. Its design features and material selection criteria fulfill the need for a reliable, long life and easy to operate gate valve.

These valves are available with either Vertical Indicators for underground water supplies or Cross Wall Indicators for interior water systems. Both indicators provide external visual indication of the open or shut valve condition as well as a locking mechanism to secure a particular wedge position.

### SPECIFICATIONS

#### Max Working Pressure

FM - 16.0 bar (232 psi)

UL - 20.8 bar (300 psi)

#### Flanges

- ASME B16.1/ASME B16.42 EN 1092-2/ISO 7005-2  
Drilled to ANSI 125/150 or PN10/PN16

#### Performance

- Contact GRINNELL Products.



For additional listings or approvals, see page 8 or visit our website at [www.grinnell.com](http://www.grinnell.com)

Valves

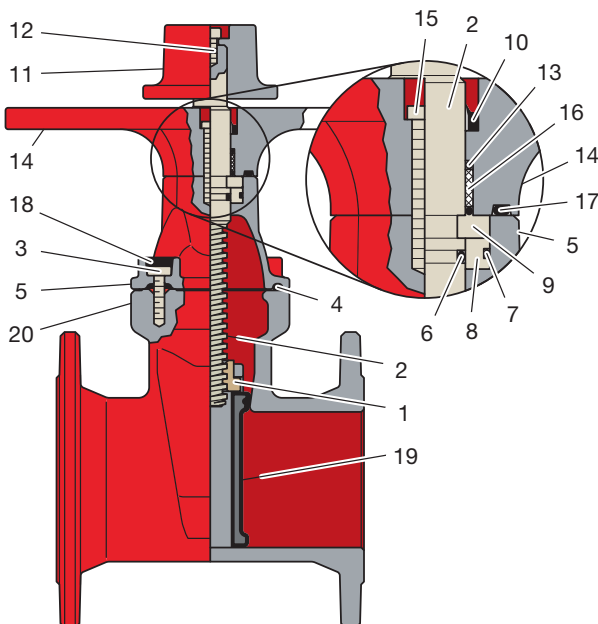

Valve Material Specifications			
Item No.	Description	Qty	Material
1	Wedge Nut	1	Bronze
2	Stem	1	Stainless
3	Bonnet Screw	4	Black Oxide Carbon Steel
4	Sealing Gasket	1	EPDM
5	Bonnet	1	FBE Coated Ductile Iron
6	Sealing O-Ring	1	NBR
7	Sealing O-Ring	1	NBR
8	Stem Ring	1	Stainless Steel
9	Stem Bearing	1	Bronze
10	Dust Guard	1	EPDM
11	Top Cap	1	FBE Coated Ductile Iron
12	Cap Screw	1	Black Oxide Carbon Steel
13	Sealing O-Ring	2	NBR
14	Indicator Flange	1	FBE Coated Ductile Iron
15	Indicator Top Screw	2	Black Oxide Carbon Steel
16	Bushing	1	Nylon
17	Sealing O-Ring	1	NBR
18	Screw Grouting	1	Activated Resin
19	Wedge	1	EPDM Coated Ductile Iron
20	Body	1	FBE Coated Ductile Iron

## Model TMCX-P Resilient-Seated Gate Valves Flange x Flange , ANSI Class #125, PN10 & PN16

(Page 2 of 5)

Tech Data Sheet: TFP1545

**10**  
YEAR  
LIMITED  
WARRANTY

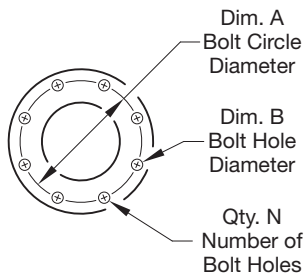
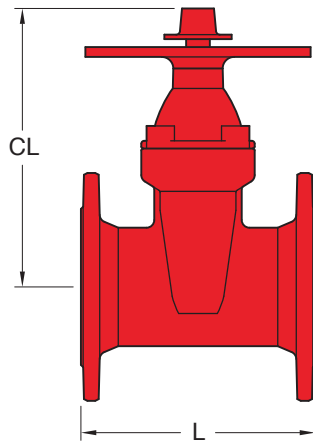

Valve Size				Approx. Weight kg Lbs
Nominal mm Inches	O.D. mm Inches	Face to face (L) mm Inches	Centre Height (CL) mm Inches	
<b>100</b> 4	<b>114.3</b> 4.500	<b>229</b> 9.00	<b>332</b> 13.07	<b>32</b> 70.5
<b>150</b> 6	<b>168.3</b> 6.625	<b>267</b> 10.50	<b>436</b> 17.17	<b>47</b> 103.6
<b>200</b> 8	<b>219.1</b> 8.625	<b>292</b> 11.50	<b>520</b> 20.47	<b>77</b> 169.7
<b>250</b> 10	<b>273.1</b> 10.750	<b>330</b> 13.00	<b>620</b> 24.41	<b>109</b> 240.3
<b>300</b> 12	<b>323.9</b> 12.750	<b>356</b> 14.00	<b>670</b> 26.38	<b>134</b> 295.4

See Valve Specifications on page 70

Valves

Gate Valve Flange Nominal Dimensions										
Valve Size		ANSI Class 150			ISO 7005-2 PN16			Table E (BS10)		
Nominal mm Inches	O.D. mm Inches	A mm Inches	B mm Inches	Qty. N	A mm Inches	B mm Inches	Qty. N	A mm Inches	B mm Inches	Qty. N
<b>100</b> 4	<b>114.3</b> 4.500	<b>190.5</b> 7.50	<b>19</b> 0.75	<b>8</b>	<b>180.0</b> 7.09	<b>19</b> 0.75	<b>8</b>	<b>178.0</b> 7.00	<b>18.0</b> 0.71	<b>8</b>
<b>150</b> 6	<b>168.3</b> 6.625	<b>241.5</b> 9.50	<b>22</b> 0.88	<b>8</b>	<b>240.0</b> 9.45	<b>22</b> 0.88	<b>8</b>	<b>235.0</b> 9.25	<b>22.0</b> 0.87	<b>8</b>
<b>200</b> 8	<b>219.1</b> 8.625	<b>298.5</b> 11.75	<b>22</b> 0.88	<b>8</b>	<b>295.0</b> 11.61	<b>22</b> 0.88	<b>12</b>	<b>292.0</b> 11.50	<b>22.0</b> 0.87	<b>8</b>
<b>250</b> 10	<b>273.1</b> 10.750	<b>362.0</b> 14.25	<b>25</b> 1.00	<b>12</b>	<b>355.0</b> 13.98	<b>28</b> 1.13	<b>12</b>	<b>365.0</b> 14.37	<b>22.0</b> 0.87	<b>12</b>
<b>300</b> 12	<b>323.9</b> 12.750	<b>432.0</b> 17.00	<b>25</b> 1.00	<b>12</b>	<b>410.0</b> 16.14	<b>28</b> 1.13	<b>12</b>	<b>406.0</b> 15.98	<b>26.0</b> 1.02	<b>12</b>

Refer to back cover for country-specific contact information.

## Model TMCT-P Resilient-Seated Gate Valves Flange x Groove ANSI Class #125, PN10 & PN16

(Page 3 of 5)

Tech Data Sheet: TFP1545

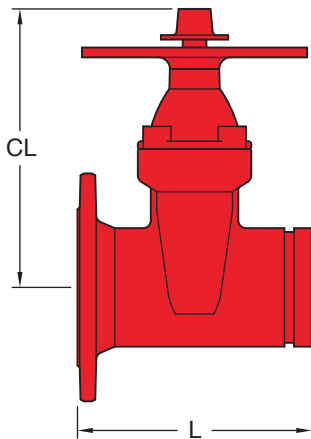

Valve Size				Approx. Weight kg Lbs
Nominal mm Inches	O.D. mm Inches	Face to face (L) mm Inches	Centre Height (CL) mm Inches	
100 4	114.3 4.500	229 9.00	332 13.07	25 55.1
150 165.1mm	165.1 6.500	267 10.50	436 17.17	38 83.8
150 6	168.3 6.625	267 10.50	436 17.17	38 83.8
200 8	219.1 8.625	292 11.50	520 20.47	61 134.5
250 10	273.1 10.750	330 13.00	620 24.41	92 202.8
300 12	323.9 12.750	356 14.00	670 26.38	119 262.4

See Valve Specifications on page 70  
See Valve Flange dimensions on prior page

Valves

## Model TMCG-P Resilient-Seated Gate Valves Groove x Groove

(Page 3 of 5)

Tech Data Sheet: TFP1545

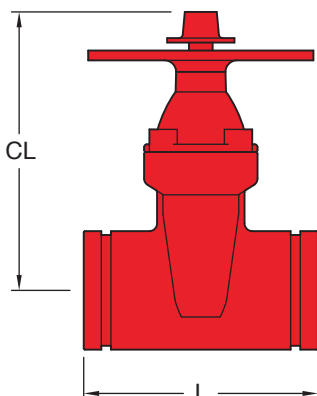

Valve Size				Approx. Weight kg Lbs
Nominal mm Inches	O.D. mm Inches	Face to face (L) mm Inches	Centre Height (CL) mm Inches	
100 4	114.3 4.500	229 9.00	332 13.07	22 48.5
150 165.1mm	165.1 6.500	267 10.50	436 17.17	34 75.0
150 6	168.3 6.625	267 10.50	436 17.17	34 75.0
200 8	219.1 8.625	292 11.50	520 20.47	56 123.5
250 10	273.1 10.750	330 13.00	620 24.41	82 180.8
300 12	323.9 12.750	356 14.00	670 26.38	107 235.9

See Valve Specifications on page 70



## Model POST-IND Vertical Indicator Post

(Page 4 of 5)

Tech Data Sheet: TFP1545

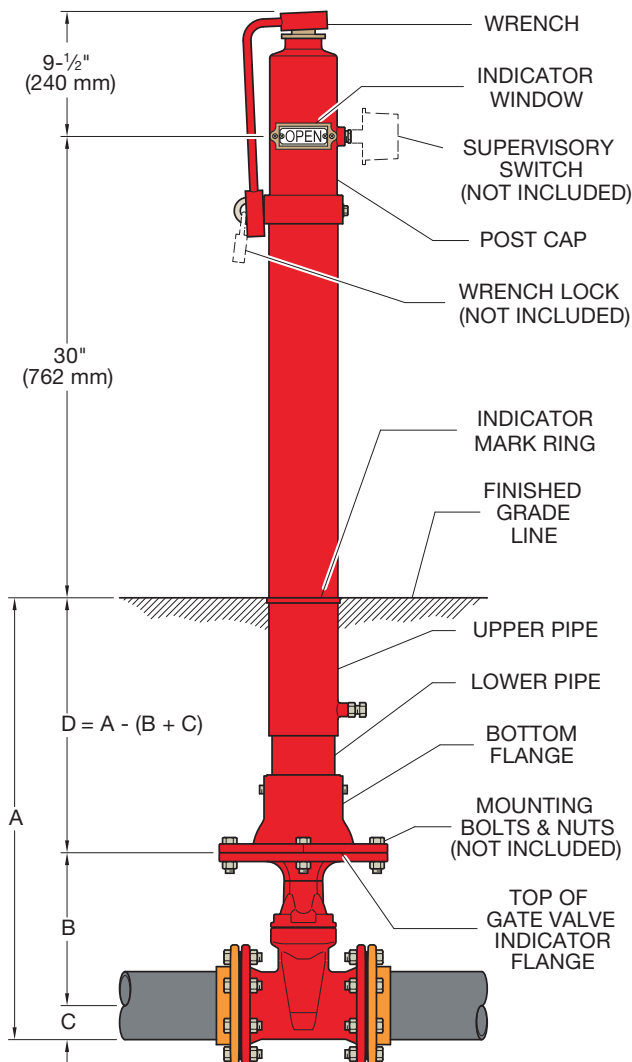

Valve Size		B Valve Height mm Inches	C Half Pipe OD mm Inches	A Trench Depth Range mm Inches	Post Type
Nominal mm Inches	O.D. mm Inches				
100 4	114.3 4.500	276 10.87	50 2	730 - 1370 28.74 - 53.94	A
				1320 - 1960 51.97 - 77.17	B
				1870 - 2510 73.62 - 98.82	C
				2420 - 3060 95.28 - 120.47	D
150 6	168.3 6.625	354 13.94	75 3	830 - 1470 32.68 - 57.87	A
				1420 - 2060 55.91 - 81.10	B
				1970 - 2610 77.56 - 102.76	C
				2530 - 3170 99.61 - 124.80	D
200 8	219.1 8.625	450 17.72	100 4	950 - 1590 37.40 - 62.60	A
				1540 - 2180 60.63 - 85.83	B
				2090 - 2730 82.28 - 107.48	C
				2650 - 3290 104.33 - 129.53	D
250 10	273.1 10.750	537 21.14	125 5	1060 - 1700 41.73 - 66.93	A
				1650 - 2290 64.96 - 90.16	B
				2200 - 2840 86.61 - 111.81	C
				2760 - 3400 108.66 - 133.86	D
300 12	323.9 12.750	606 23.86	150 6	1160 - 1800 45.67 - 70.87	A
				1750 - 2390 68.90 - 94.09	B
				2300 - 2940 90.55 - 115.75	C
				2850 - 3490 112.20 - 137.40	D

See Valve Specifications on page 70

## Model WALL-IND Cross Wall Indicator Post

(Page 5 of 5)

Tech Data Sheet: TFP1545



Valve Size		A	B	Approx. Weight kg Lbs
Nominal mm Inches	O.D. mm Inches	Connect Cap Engagement Height mm Inches	Valve Height mm Inches	
100 4	114.3 4.500	299 11.77	276 10.87	36 79.0
150 6	168.3 6.625	403 15.87	354 13.94	36 79.0
200 8	219.1 8.625	487 19.17	450 17.72	36 79.0
250 10	273.1 10.750	587 23.11	537 21.14	36 79.0
300 12	323.9 12.750	637 25.08	606 23.86	36 79.0

See Valve Specifications on page 70

Valves

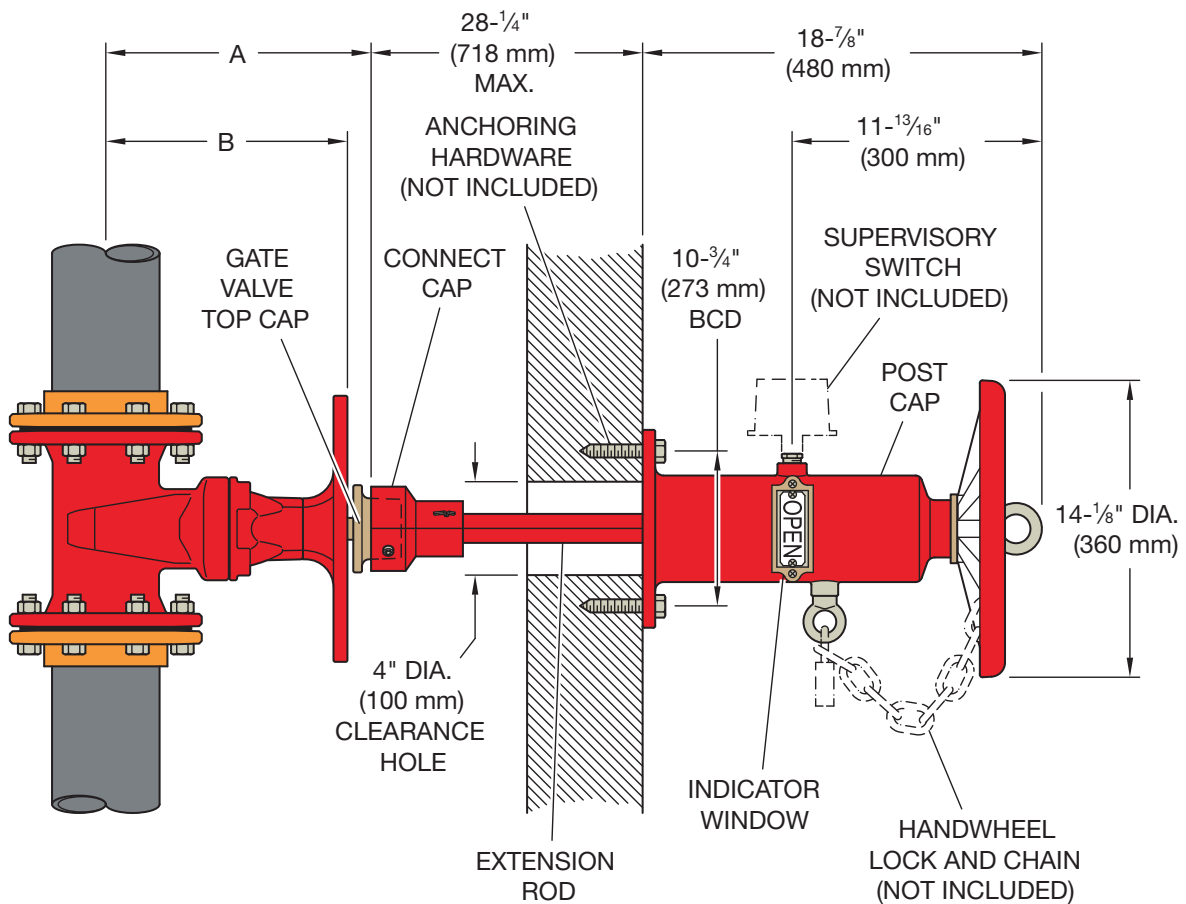



/ G-FIRE /  
GASKETS /

## GRINNELL Gasket Seal

Tech Data Sheet: TFP1895

Pressure responsive gaskets are offered in a variety of types. Although they each serve a specific function they all utilise the same sealing design.

The GRINNELL gasket is designed to provide a three-way sealing action.

- (1) Installation of the gasket over the outside sealing surface of the pipe compresses the lip seal and forms the initial seal.
- (2) The installation of the housing segments around the gasket and into the pipe groove properly positions the gasket. Tightening of the housing segments forms the gasket to the inside of the housing and compresses it around the pipe-sealing surface thus increasing the gasket's sealing against the pipe.
- (3) The introduction of the system pressure energises the pressure responsive seal of the gasket and further enhances the sealing action.

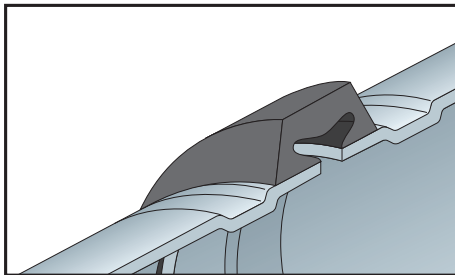

### First Seal

C-shaped rubber gasket seals on pipe ends.

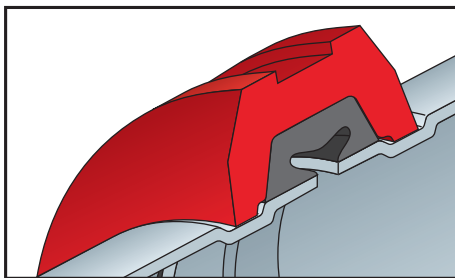

### Second Seal

The housings compress the gasket to increase the sealing capacity.

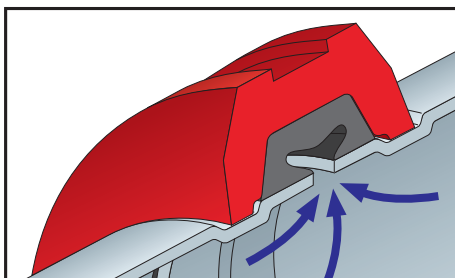

### Third Seal

The system pressure or vacuum will then maximise the leak-tight seal.



## Gasket Styles

Tech Data Sheet: TFP1895

### Standard

The standard style gasket, with a "C" shape configuration, is the most commonly used. It is provided as the standard gasket in the Figure 577, 705, 707, and 770 GRINNELL Couplings. The gasket is available in Grade "E" EPDM or Grade "A" EPDM.



### Tri-Seal

The tri-seal gasket is designed to close off the gap or gasket cavity. This is accomplished by positioning the centre "rib" of the gasket over the gap between the pipes. The tri-seal gasket has two tapered sealing edges in addition to the centre rib for additional strength and sealing.



The Tri-Seal gasket can be used with the Figure 577, 705, and 707 GRINNELL Couplings. It is recommended for use in low temperature and vacuum services (greater than 250mm Hg (10" Hg)) applications and potable water systems. Note only a petroleum-free silicone based lubricant is recommended for low temperature applications. The gasket is available in Grade "E", "EN" EPDM.

**Note:** Rigid couplings are recommended for vacuum and low temperature applications.

### Reducing Coupling

The reducing gasket is provided with ribs used to position the larger pipe so that the sealing lip is located on the sealing surface of the pipe. This gasket is used only with the Figure 716 GRINNELL Reducing Coupling and is available in Grade "E" EPDM.



**Reducing couplings are not recommended for low temperature applications.**

### Flange Adaptor

This gasket is specifically designed for use with the Figure 71 Flange Adaptor. The gasket has an optimum amount of rubber to provide a dependable seal between both the pipe and mating surface. The gasket is available in Grade "E" EPDM.

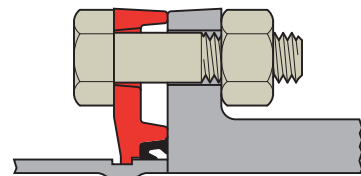

### Mechanical Tee

The gasket provides a compression type seal, which is designed to conform to the exterior curve (OD) of the pipe. This design is unique to the Figure 730 Mechanical Tee (threaded and grooved). The gasket is available in Grade "E" EPDM.

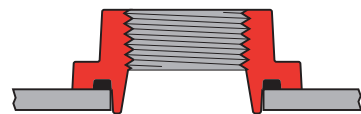

**Note:** When used in low temperature applications, use a petroleum-free silicone based lubricant, otherwise no lubricant is required on Mechanical Tee gaskets.

### Outlet Coupling

This gasket is specifically designed for use with the GRINNELL Figure 702 Outlet Coupling.

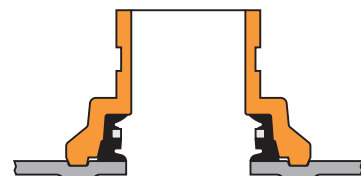

GRINNELL gaskets are designed exclusively for use with GRINNELL manufactured coupling housings. The mixing of other manufacturer's gaskets or housings with GRINNELL gaskets or housings may result in pipe joint leakage or failure and will void the GRINNELL Products limited warranty.

## GRINNELL Gasket Grade & Recommendations

Tech Data Sheet: TFP1895

The Gasket Recommendation Table has been developed to assure maximum service life. The table was developed from information supplied by the material manufacturers of the elastomer, technical reference literature, and testing conducted by GRINNELL Products.

In evaluating the gasket grade for intended service applications the following consideration must be reviewed: system operating temperature, fluid or solution concentration, and duration of service.

All gasket recommendations are based on a temperature of 21°C (70°F) unless otherwise noted.

Technical and Engineering Services should be consulted (Phone 1300 725 688, Fax +61 3 9933 6204) if combinations of service solutions are being considered.

Contact GRINNELL Products for recommendations for services not listed.

Gasket recommendations apply to GRINNELL gaskets and valves only.

Grade	Temperature Range	Compound	Colour Code	General Service Application
"A" Pre-Lubricated	-34°C to 66°C (-30°F to 150°F)	EPDM	Violet	Fire Protection systems. Not recommended for hot water systems.
"E"	-34°C to 110°C (-30°F to 230°F)	EPDM	Green	Fire Protection systems.
"E" Tri-Seal	-34°C to 110°C (-30°F to 230°F)	EPDM	Green	Fire Protection systems. For dry pipe or freezer systems

For local country potable water approvals contact GRINNELL Products



## GRINNELL Gasket Lubricants

Tech Data Sheet: TFP1895

During installation of a GRINNELL Coupling, always lubricate the gasket. For couplings using the tri-seal gasket in a low temperature application, use a petroleum-free silicone based lubricant. For mechanical tees and straps when used in low temperature applications, use a petroleum-free silicone based lubricant, otherwise no lubricant is required.

GRINNELL Piping Products recommends two kinds of lubricant:

- La-Co Industries Lubri-Joint
- Dow Corning\* 7 Release Compound (Silicone)

Check lubricant chart to be certain the proper lubricant is recommended for the service intended. For information on health safety, contact GRINNELL Products for Material Safety Data Sheets (MSDS).

Application	La-Co Industries Lubri-Joint	Dow Corning* 7 Release Compound (Silicone)
Chilled Water	•	•
Heating	•	•
Compressed Air	•	•
Drainage	•	•
Sewage	•	•
Low Temp./Vacuum	•	•
Fire Protection	•	•



Available in:

- 0.95 Litre (1 Quart)
- 3.8 Litre (1 Gallon)

Silicone Gasket Lubricant recommended for use with tri-seal gasket (Dow Corning D.C. No. 7)\* available in:











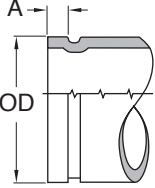

- 150 grammes (5.3 oz) Tube
- 3.6 kg (8 lb) Can

\* Dow Corning is a registered trademark of Dow Corning Corporation.



## PREPARATION EQUIPMENT

## Preparation Equipment Pictorial Table of Contents

 <p><b>Grooving Specifications</b> Pages – 81 - 82</p>	 <p><b>Hole Cutting Tools</b> Page – 84</p>
 <p><b>Automated Roll Groovers</b> Page – 83</p>	 <p><b>Pipe Tape</b> Page – 84</p>
 <p><b>Portable Roll Groovers</b> Page – 83</p>	 <p><b>Model TWG-IV A</b> Roll Grooving Machine Page – 85</p>
 <p><b>Field Portable Roll Groovers</b> Page – 83</p>	 <p><b>Model TWG-IV Z</b> Automatic Roll Grooving Machine Page – 86</p>
 <p><b>Portable Cut Groovers</b> Page – 84</p>	 <p><b>Model TWG-VI A</b> Portable Roll Grooving Machine Page – 87</p>
 <p><b>Pipe Support Stands</b> Page – 84</p>	 <p><b>Model TWK-III A</b> Hole Cutting Tool Page – 88</p>

Preparation Equipment



## Roll Groove Standard Specification for Steel & Other IPS Pipe

Tech Data Sheet: TFP1898

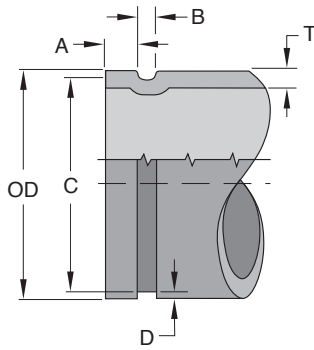

Nominal Pipe Size mm Inches	Pipe O.D. mm Inches			A ±0.76mm ±0.030" mm Inches	B ±0.76mm ±0.030" mm Inches	C Groove Diameter mm Inches		D Groove Depth (ref. only) mm Inches	T Minimum Wall mm Inches	Maximum Allow Flare Diameter mm Inches
	O.D.	Tolerance				Actual	Tol. +0.000			
		+	-							
25	33.4	0.33	0.33	15.88	7.14	30.23	-0.38	1.60	1.65	36.32
1	1.315	0.013	0.013	0.625	0.281	1.190	-0.015	0.063	0.065	1.743
32	42.4	0.41	0.41	15.88	7.14	38.99	-0.38	1.60	1.65	44.96
1¼	1.660	0.016	0.016	0.625	0.281	1.535	-0.015	0.062	0.065	1.77
40	48.3	0.48	0.48	15.88	7.14	45.09	-0.38	1.60	1.65	51.05
1½	1.900	0.019	0.019	0.625	0.281	1.775	-0.015	0.062	0.065	2.01
50	60.3	0.61	0.61	15.88	8.74	57.15	-0.38	1.60	1.65	62.99
2	2.375	0.024	0.024	0.625	0.344	2.250	-0.015	0.062	0.065	2.48
65	73.0	0.74	0.74	15.88	8.74	69.09	-0.46	1.98	2.11	75.69
2½	2.875	0.029	0.029	0.625	0.344	2.720	-0.018	0.078	0.083	2.98
65	76.1	0.76	0.76	15.88	8.74	72.26	-0.46	1.93	2.11	78.74
76,1mm	3.000	0.030	0.030	0.625	0.344	2.845	-0.018	0.076	0.083	3.10
80	88.9	0.89	0.79	15.88	8.74	84.94	-0.46	1.98	2.11	91.44
3	3.500	0.035	0.031	0.625	0.344	3.344	-0.018	0.078	0.083	3.60
100	108.0	1.09	0.79	15.88	8.74	103.73	-0.51	2.11	2.11	110.49
108.0mm	4.252	0.043	0.031	0.625	0.344	4.084	-0.020	0.083	0.083	4.35
100	114.3	1.14	0.79	15.88	8.74	110.08	-0.51	2.11	2.11	116.84
4	4.500	0.045	0.031	0.625	0.344	4.334	-0.020	0.083	0.083	4.60
125	133.0	1.35	0.79	15.88	8.74	129.13	-0.56	2.11	2.77	135.89
133.0mm	5.236	0.053	0.031	0.625	0.344	5.084	-0.022	0.083	0.109	5.35
125	139.7	1.42	0.79	15.88	8.74	135.48	-0.56	2.11	2.77	142.24
139,7mm	5.500	0.056	0.031	0.625	0.344	5.334	-0.022	0.083	0.109	5.60
125	141.3	1.42	0.79	15.88	8.74	137.03	-0.56	2.13	2.77	143.76
5	5.563	0.056	0.031	0.625	0.344	5.395	-0.022	0.084	0.109	5.66
150	159.0	1.60	0.79	15.88	8.74	154.53	-0.76	2.11	2.77	161.29
159.0mm	6.260	0.063	0.031	0.625	0.344	6.084	-0.030	0.083	0.109	6.35
150	165.1	1.60	0.79	15.88	8.74	160.78	-0.56	2.16	2.77	167.64
165,1mm	6.500	0.063	0.031	0.625	0.344	6.330	-0.022	0.085	0.109	6.60
150	168.3	1.60	0.79	15.88	8.74	163.96	-0.56	2.16	2.77	170.94
6	6.625	0.063	0.031	0.625	0.344	6.455	-0.022	0.085	0.109	6.73
200	219.1	1.60	0.79	19.05	11.91	214.40	-0.64	2.34	2.77	223.52
8	8.625	0.063	0.031	0.750	0.469	8.441	-0.025	0.092	0.109	8.80
250	273.0	1.60	0.79	19.05	11.91	268.27	-0.69	2.39	3.40	277.37
10	10.750	0.063	0.031	0.750	0.469	10.562	-0.027	0.094	0.134	10.92
300	323.9	1.60	0.79	19.05	11.91	318.19	-0.76	2.77	3.96	328.17
12	12.750	0.063	0.031	0.750	0.469	12.531	-0.030	0.109	0.156	12.92

- The maximum allowable tolerances for IPS Pipe from square cut ends is:  
0.76mm (0.030") for sizes 32mm – 80mm (1¼" thru 3");  
1.14mm (0.045") for sizes 100mm – 150mm (4" – 6"); and  
1.52mm (0.060") for sizes 200mm (8") and above.
- Gasket Seating Surface "A" must be free from score marks, ridges, indentations, projections, loose paint, scale, dirt chips, grease, rust, etc. that would prevent a positive seal.
- Groove Diameter "C" must be of uniform depth around the circumference of the pipe.
- Groove Depth "D" is a reference dimension only. The Groove Diameter "C" must be maintained.
- Minimum Wall Thickness "T" is the minimum wall thickness that should be roll grooved.
- Maximum allowable pipe end flare diameter is measured at the pipe end diameter.

Refer to back cover for country-specific contact information.

## Cut Groove Standard Specification for Steel & Other IPS Pipe

Tech Data Sheet: TFP1898

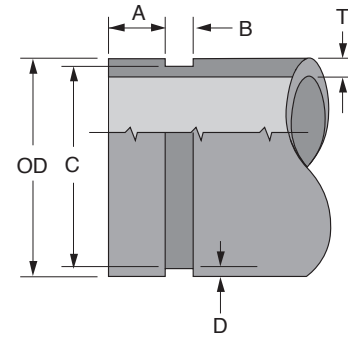

Nominal Pipe Size mm Inches	Pipe O.D. mm Inches		A ±0.76mm ±0.030" mm Inches	B ±0.76mm ±0.030" mm Inches	C Groove Diameter mm Inches		D Groove Depth (ref. only) mm Inches	T Minimum Wall mm Inches	
	O.D.	Tolerance			Actual	Tol. +0.000			
		+							-
25	33.4	0.33	0.33	15.88	7.95	30.23	-0.38	1.57	3.38
1	1.315	0.013	0.013	0.625	0.313	1.190	-0.015	0.062	0.133
32	42.4	0.41	0.41	15.88	7.95	38.99	-0.38	1.60	3.56
1¼	1.660	0.016	0.016	0.625	0.313	1.535	-0.015	0.062	0.140
40	48.3	0.48	0.48	15.88	7.95	45.09	-0.38	1.60	3.68
1½	1.900	0.019	0.019	0.625	0.313	1.775	-0.015	0.062	0.145
50	60.3	0.61	0.61	15.88	7.95	57.15	-0.38	1.60	3.91
2	2.375	0.024	0.024	0.625	0.313	2.250	-0.015	0.062	0.154
65	73.0	0.74	0.74	15.88	7.95	69.09	-0.46	1.98	4.78
2½	2.875	0.029	0.029	0.625	0.313	2.720	-0.018	0.078	0.188
65	76.1	0.76	0.76	15.88	7.95	72.26	-0.46	1.93	4.78
76,1mm	3.000	0.030	0.030	0.625	0.313	2.845	-0.018	0.076	0.188
80	88.9	0.89	0.79	15.88	7.95	84.94	-0.46	1.98	4.78
3	3.500	0.035	0.031	0.625	0.313	3.344	-0.018	0.078	0.188
100	108.0	1.07	0.79	15.88	9.53	103.73	-0.51	2.11	5.16
108.0mm	4.252	0.042	0.031	0.625	0.375	4.084	-0.020	0.083	0.203
100	114.3	1.14	0.79	15.88	9.53	110.08	-0.51	2.11	5.16
4	4.500	0.045	0.031	0.625	0.375	4.334	-0.020	0.083	0.203
125	133.0	1.35	0.79	15.88	9.53	129.13	-0.51	2.11	5.16
133.0mm	5.236	0.052	0.031	0.625	0.375	5.084	-0.020	0.083	0.203
125	139.7	1.42	0.79	15.88	9.53	135.48	-0.51	2.11	5.16
139,7mm	5.500	0.056	0.031	0.625	0.375	5.334	-0.020	0.083	0.203
125	141.3	1.42	0.79	15.88	9.53	137.03	-0.56	2.13	5.16
5	5.563	0.056	0.031	0.625	0.375	5.395	-0.022	0.084	0.203
150	159.0	1.60	0.79	15.88	9.53	154.53	-0.56	2.11	5.56
159.0mm	6.260	0.063	0.031	0.625	0.375	6.084	-0.022	0.083	0.219
150	165.1	1.60	0.79	15.88	9.53	160.78	-0.56	2.16	5.56
165,1mm	6.500	0.063	0.031	0.625	0.375	6.330	-0.022	0.085	0.219
150	168.3	1.60	0.79	15.88	9.53	163.96	-0.56	2.16	5.56
6	6.625	0.063	0.031	0.625	0.375	6.455	-0.022	0.085	0.219
200	219.1	1.60	0.79	19.05	11.13	214.40	-0.64	2.34	6.05
8	8.625	0.063	0.031	0.750	0.438	8.441	-0.025	0.092	0.238
250	273.0	1.60	0.79	19.05	12.70	268.27	-0.69	2.39	6.35
10	10.750	0.063	0.031	0.750	0.500	10.562	-0.027	0.094	0.250
300	323.9	1.60	0.79	19.05	12.70	318.19	-0.76	2.77	7.09
12	12.750	0.063	0.031	0.750	0.500	12.531	-0.030	0.109	0.279

- The maximum allowable tolerances for IPS Pipe from square cut ends is:  
0.76mm (0.030") for sizes 32mm – 80mm (1¼" thru 3");  
1.14mm (0.045") for sizes 100mm – 150mm (4" – 6"); and  
1.52mm (0.060") for sizes 200mm (8") and above.
- Gasket Seating Surface "A" must be free from score marks, ridges, indentations, projections, loose paint, scale, dirt chips, grease, rust, etc. that would prevent a positive seal.
- Groove Diameter "C" must be of uniform depth around the circumference of the pipe.
- Groove Depth "D" is a reference dimension only. The Groove Diameter "C" must be maintained.
- Minimum Wall Thickness "T" is the minimum wall thickness that should be cut grooved.

## Grooving Equipment

Example equipment is shown on the next three pages. Additional grooving equipment and equipment with APAC electrical requirements are also available. Contact GRINNELL Products for more information.

Roll grooving machines are available for rent. Contact your GRINNELL Products representative for details and availability.

### Automated Roll Groovers

Automated Roll Grooving Machines are designed for use in the shop. The machines have a self-contained hydraulic system that produces consistent quality roll grooves in high production runs.

- Schedule 40, 32mm – 300mm (1¼" – 12")
- Schedule 10, 40mm – 300mm (1½" – 12")
- Standard Wall, 300mm – 600mm (12" – 24")
- Pipe rotation speed of 30 RPM

**STANDARD EQUIPMENT**

Electric Drive Motor, Limit Switch for Depth Gauging, Groove Depth Gauge, Hydraulic Pump, Nipple Bracket, Rolls As Specified in Price List, Guards, Foot Switch



### Portable Roll Groovers

- Schedule 40 Capacity 32mm – 300mm (1¼" – 12")
- Schedule 10 Capacity 25mm – 300mm (1" – 12")
- Standard Wall, 300mm – 600mm (12" – 24")
- Hydraulic pressure at roller is 55,158 kPa (8,000 psi) max

**STANDARD EQUIPMENT**

Top & Bottom Rolls 25mm – 300mm (1" – 12"), Hydraulic Hand Pump, Grooved Depth Gauge and Guards  
Equipment is available with APAC electrical requirements



Preparation  
Equipment

### Field Portable Roll Groovers

- Schedule 40, 32mm – 300mm (1¼" – 12")
- Manual grooving with ratchet hand crank
- Standard Wall, 300mm – 600mm (12" – 24")
- Self-contained

**STANDARD EQUIPMENT**

Multi-Function Ratchet Hand Crank  
Equipment is available with APAC electrical requirements

**OPTIONAL EQUIPMENT**

Top and Bottom Rolls Steel Pipe



## Portable Cut Groovers

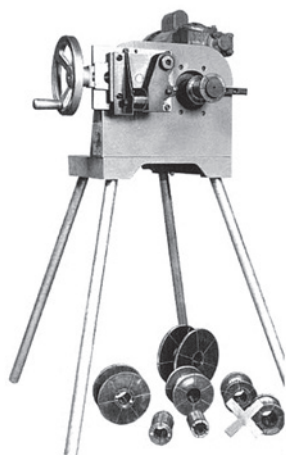

- Schedule 40 50mm – 300mm (2" – 12")
- Schedule 80 65mm – 200mm (2½" – 8")
- Collet chucks for 250mm and 300mm (10" and 12") pipe available
- Tooling for cut grooving ductile iron pipe also available
- Special collet chucks for non-standard dimension pipe can be supplied

### STANDARD EQUIPMENT

Collet Chucks for 50mm – 200mm (2" – 8"), 4 High Speed Steel Grooving Blades, Groove Gauge, Shipping/Storage Box

## Pipe Support Stands



**Capacity:** 25mm – 100mm (1" – 4") Pipe; 272 kg (600 lbs) max

A 559mm (22") diameter base with 51mm (2") column gives this stand plenty of strength for supporting any pipe size in its size range. The saddle has two roller bar bearings for free rotation of the pipe and absorbs vibration to ensure a smooth, uniform groove. Saddle height is adjustable over a 254mm (10") range.

## Hole Cutting Tools

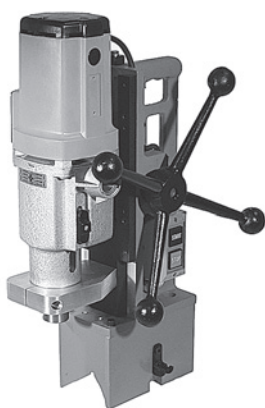

- Solid alloy aluminium construction
- Circuit breaker assures no safety hazard to the operator or machine
- Chain clamp is standard on all units and clamps to pipe diameters
- Optional speed toggle clamps; 32mm – 150mm (1¼" – 6") pipe
- Oil feed

Preparation  
Equipment

## Pipe Tape



**Model GRNTAPE** was developed to check the groove diameter in roll-grooved pipe. The tape measures the groove in steel pipe 25mm – 300mm (1" – 12").

The loop extending from the metal housing consists of a clear-plastic window with a vertical indicator line and the adjustable metal measuring tape. The adjustable measuring tape has groove tolerance blocks (thick black lines) that are visible through the plastic view window. The groove tolerance blocks are marked with the associated pipe diameters.

**Note:** The GRINNELL roll pipe measuring tape is not a calibrated tool and is to be used for reference only. To ensure accuracy, always check grooved pipe dimensions with calibrated gauges or callipers. For roll groove standard specifications for steel pipe and other IPS pipe, refer to Data Sheet G710 or TFP1898.

## Model TWG-IV A Roll Grooving Machine

- This machine is applicable for grooving of the end of 200 - 600mm (8" - 24") steel pipes with a maximum wall thickness of 12mm. (0.47")
- Come with latest hydraulic pump plus stroke limitation devices to precisely and effectively control the depth of groove.
- The high-power high-performance gear reducing motor coupled with the steel pipe guide wheel ensures high channeling quality plus high working efficiency.
- Come with a foldable hydraulic steel support to contribute to easier operation and labor saving.

### Technological Parameters

#### • Processing Capability

200 - 600mm (8" - 24") Steel pipe  
 Max. wall thickness: 12mm (0.47")  
 Output RPM: 14 rotations/m

#### • Driving Power

Three-phase motor, Voltage: 110 - 415V,  
 Power Capacity: 1500W, Frequency : 50 - 60Hz  
 N.W. : 235kg (518lbs)  
 Packaging size : 1010 x 810 x 1400mm (39.8" x 31.9" x 55.1")

Single-phase motor, Voltage : 110 - 240V.  
 Power capacity: 2200 - 3000W. Frequency: 50 - 60Hz  
 N.W.: 240kg (529lbs)  
 Packaging size: 1060 x 810 x 1400mm

#### • Standard Configuration

Hydraulic Steel pipe support , one piece  
 A set of 200 - 600mm (8" - 24") knurl wheel, 3 pieces,  
 A set of 200 - 600mm (8" - 24") pinch roll, 2 pieces,  
 A set of guide wheel



Description	Photo Number	Approx Weight Kg Lbs.
TWG-IV A – Three -phase 1500W		350 771
TWG-IV A – Single -phase 2200 - 3000W		240 529
Hydraulic Steel Pipe Support	1	55.0 121.3
Guide Wheel	2	7.7 16.9
Small Knurl Wheel 219 - 325mm (8" - 12")	3	9.0 19.8
Medium Knurl Wheel 377 - 426mm (14" - 16")	4	8.7 19.2
Large Knurl Wheel 480 - 630mm (18" - 24")	5	8.3 18.3
Small Pinch Roll 219 - 530mm (8" - 20")	6	1.0 2.2
Large Pinch Roll 630mm (24")	7	1.0 2.2

Preparation  
Equipment

## Model TWG-IV Z Automatic Roll Grooving Machine



- This machine is applicable for grooving of the end of 200 - 600mm (8" - 24") steel pipe.
- The machine using automatic hydraulic control system and auto-feed.
- This machine can insure high quality effects of grooving and high-level efficiency to work.
- The unique design of oil pump which can limit check nut, it in order to same deepness when grooving. It is much easy and accurate to operate.
- There is a wheel assembly at the bottom of the machine, making it easy to transport and conversion working place.

### Technological Parameters

#### • Processing Capability

200 - 600mm (8" - 24") Steel pipe  
 200 - 300mm (8" - 12") Plastic-lining pipe  
 Max. wall thickness: 12mm (0.47")  
 Output RPM: 14 - 23 rotations/m

#### • Driving Power

Three - phase motor, Voltage: 110 - 415V,  
 Power Capacity: 2200W, Frequency: 50 - 60Hz  
 N.W.: 425kg (937lbs) Support: 110kg (243lbs)  
 Packaging size: 1070 x 850 x 1680mm  
 Support Packaging Size: 980 x 980 x 630mm

Single-phase motor, Voltage: 110 - 240V,  
 Power capacity: 2200 - 3000W, Frequency: 50 - 60Hz  
 N.W.: 435kg (959lbs) Support: 110kg (243lbs)  
 Packaging size: 1070 x 850 x 1680mm  
 Support Packaging Size: 980 x 980 x 630mm

#### • Standard Configuration

Hydraulic Steel pipe support, one piece  
 Hi-support Hydraulic pump, one piece  
 A set of 200 - 600mm (8" - 24") knurl wheel, 3 pieces,  
 A set of 200 - 600mm (8" - 24") pinch roll, 2 pieces,  
 A set of guide wheel, Foot Switch, one piece

Description	Photo Number	Approx Weight Kg Lbs.
TWG-IV Z – Three -phase 2200W		490 1080
TWG-IV Z – Single-phase 2200 - 3000W		500 1102
Hydraulic Steel Pipe Support	1	140.0 308.6
Hi-support Hydraulic Pump	2	12.0 26.5
Guide Wheel	3	7.7 16.9
Foot Switch	4	7.7 16.9
Small Knurl Wheel 219 - 325mm (8" - 12")	5	9.0 19.8
Medium Knurl Wheel 377 - 426mm (14" - 16")	6	8.7 19.2
Large Knurl Wheel 480 - 630mm (18" - 24")	7	8.3 18.3
Small Pinch Roll 219 - 530mm (8" - 20")	8	1.0 2.2
Large Pinch Roll 630mm (24")	9	1.0 2.2



Preparation  
Equipment

## Model TWG-VI A Portable Roll Grooving Machine

- This machine is applicable for grooving of the end of 25 - 300mm (1" - 12") steel pipes.
- The knurl shaft employs taper connection to facilitate the changing of knurl wheels.
- The unique foldable carriage allows the machine be folded and moved by one person.
- The split-type oil pump coupled with pedal switch enables safer and easier operation .

### Technological Parameters

#### • Processing Capability

25 - 300mm (1" - 12") Steel pipe  
 25 - 80mm (1" - 3") Plastic-lining pipe  
 Max. wall thickness: 10mm  
 Output RPM : 23 - 36 rotations/m

#### • Driving Power

Three -phase motor, Voltage : 110 - 415V.  
 Power Capacity: 1100W . Frequency: 50 - 60Hz  
 N.W. : 205kg (451lbs)  
 Packaging size: 1440 x 840 x 1180mm

Single-phase motor, Voltage : 110 - 240V.  
 Power capacity: 1500W. Frequency: 50 - 60Hz  
 N.W.: 208kg (459lbs)  
 Packaging size: 1440 x 840 x 1180

#### • Standard Configuration

Steel pipe support , one piece  
 A set of 25 - 300mm (1" - 12") knurl wheel, 4 pieces,  
 A set of 25 - 300mm (1" - 12") pinch roll , 4 pieces ,  
 A set of guide wheel

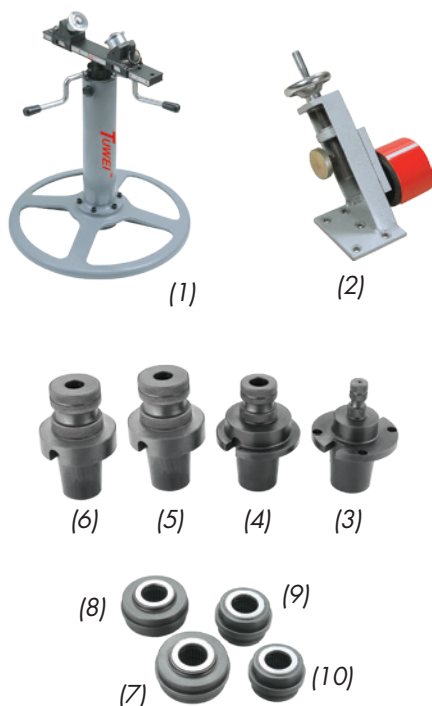

Description	Photo Number	Approx Weight Kg Lbs.
<b>TWG-VI A – Three -phase 1100W</b>		<b>245</b> 540
<b>TWG-VI A – Single-phase 1500W</b>		<b>248</b> 547
<b>Steel Pipe Support</b>	1	<b>22.5</b> 49.6
<b>Guide Wheel</b>	2	<b>6.7</b> 14.8
<b>Small Knurl Wheel 33 - 48mm (1" - 1-1/2")</b>	3	<b>2.6</b> 5.7
<b>Medium Knurl Wheel 60 - 89mm (2" - 3")</b>	4	<b>3.3</b> 7.3
<b>Medium Knurl Wheel 114 - 168mm (4" - 6")</b>	5	<b>4.0</b> 8.8
<b>Large Knurl Wheel 219 - 325mm (8" - 12")</b>	6	<b>4.0</b> 8.8
<b>Small Pinch Roll 33 - 48mm (1" - 1-1/2")</b>	7	<b>1.5</b> 3.3
<b>Medium Pinch Roll 60 - 89mm (2" - 3")</b>	8	<b>1.5</b> 3.3
<b>Medium Pinch Roll 114 - 168mm (4" - 6")</b>	9	<b>1.0</b> 2.2
<b>Large Pinch Roll 219 - 325mm (8" - 12")</b>	10	<b>1.0</b> 2.2

## Model TWK-III A Hole Cutting Tool



- This machine is applicable for tapping of holes with diameter up to 16 - 114mm ( $\frac{5}{8}$ " - 4- $\frac{1}{2}$ " ) on a steel pipe. Come with a high-performance low-noise gear motor to offer high torque .
- Best for tapping operation on pipes in mechanical and fire-fighting sectors

### Technological Parameters

- **Processing Capability**

16 - 114mm ( $\frac{5}{8}$ " - 4- $\frac{1}{2}$ " )  
Output RPM : 110 rotations/m

- **Driving Power**

Three -phase motor, Voltage: 110 - 415V.  
Power Capacity: 550W. Frequency: 50 - 60Hz  
N.W. : 20kg (44lbs)  
Packaging size: 340 x 340 x 620mm

Single-phase motor, Voltage: 110-240V.  
Power capacity:550 - 800W. Frequency: 50 - 60Hz  
N.W. : 20kg (44lbs)  
Packaging size: 340 x 340 x 620mm

- **Standard Configuration**

Tightening chain, one piece  
Handle, 1 set



Preparation  
Equipment



(1)



(2)

Description	Photo Number	Approx Weight Kg Lbs.
TWK-III A – Three -phase 550W		29 63.9
TWK-III A – Single-phase 550W		29 63.9
Tightening Chain	1	1.0 2.2
Handle, 1 Set	2	0.4 0.9



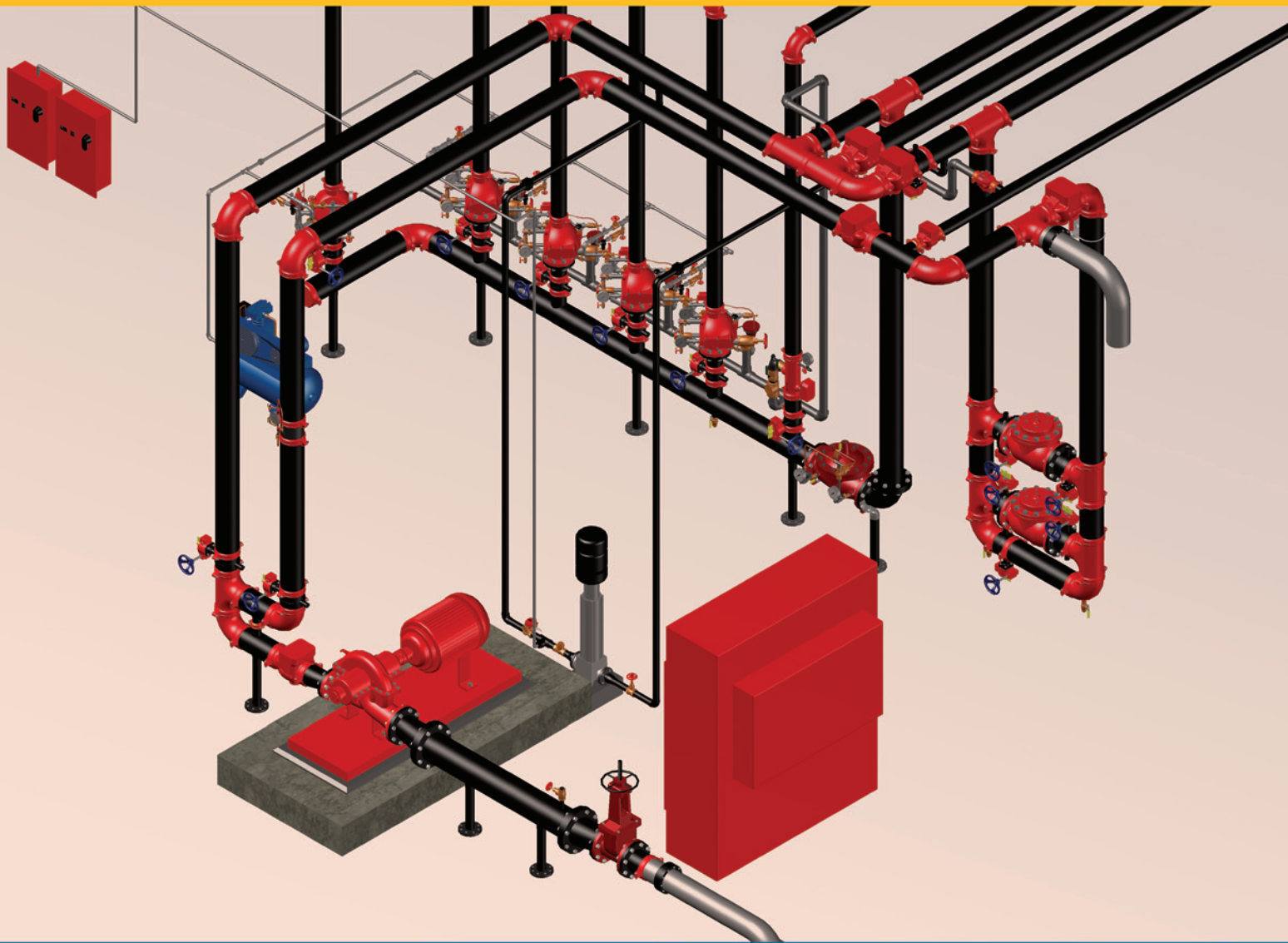

PRESSURE &  
DESIGN DATA

## Design

Tech Data Sheets: TFP1800, G820, G830

### Rigid Joints

GRINNELL Rigid Couplings provide rigid gripping of the pipe. They are designed to bring the pipe ends close together and to ensure the coupling clamps firmly onto the pipe OD and the bottom of the grooves. Because rigid couplings clamp around the entire pipe surface, they provide resistance to flexural and torsional loads and therefore permit longer spacing to ASME/ANSI B31.1 (Power Piping) and ASME/ANSI B39.1 (Building Services) requirements.

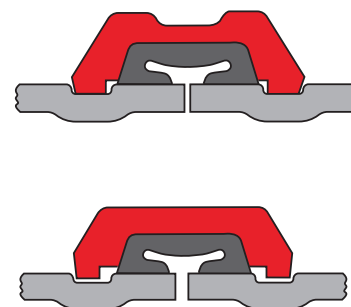

### Flexible Joints

GRINNELL Flexible Couplings act as an "expansion joint", allowing linear and angular movement of the pipe. They are designed with the coupling keys engaging the pipe without gripping on the bottom of the grooves, while still providing for a restrained mechanical joint. This is particularly useful to allow for pipe expansion/contraction and piping misalignment.

#### Linear Movement (Flexible Couplings)

For thermal expansion with flexible couplings, the pipe ends at each joint should be fully gapped to the maximum amount. This can be accomplished by pressurising the system and then anchoring the system.

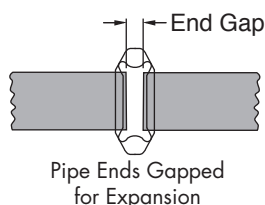

For thermal contraction with flexible couplings, the pipe ends at each joint should be fully butted. The system can then be anchored in place to prevent the pipe ends from opening up to the maximum end gap when pressurised.

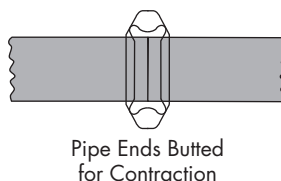

### Angular Deflection

GRINNELL Flexible Couplings are capable of accommodating angular deflection.

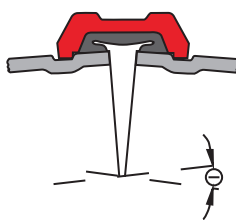

### Expansion/Contraction

GRINNELL Flexible Couplings are capable of accommodating pipe thermal movements provided they are properly gapped and a sufficient quantity of flexible couplings are used. Note that flexible couplings will not accommodate both full maximum linear movement and the maximum available angular deflection concurrently at the same joint.

If it is desired to have both deflection and linear movement available, then the system should have sufficient flexible joints to accommodate the requirement.



For design purposes, the maximum pipe end gap should be reduced to account for field practises as follows:

End Gap Reduction	
Pipe Size mm Inches	Maximum Pipe End Gap
42.4 – 88.9 1½ – 3	50%
114.3 – 610.0 4 – 24	25%

The following values should be used as available pipe end movements for GRINNELL Figure 705, 707, and 716 Flexible Couplings:

Pipe Size mm Inches	Pipe End Movements	
	Cut Grooved mm Inches	Roll Grooved mm Inches
42.4 – 88.9 1½ – 3	0 – 1.6 0 – 0.063	0 – 0.8 0 – 0.031
114.3 – 610.0 4 – 24	0 – 2.4 0 – 0.188	0 – 2.4 0 – 0.094

\* Roll grooved joints provide half the available movement of cut grooved joints.

The deflection published is a maximum value. For design purposes the maximum deflection should be reduced to account for field practises as shown:

Deflection	
Pipe Size mm Inches	Maximum Pipe Deflection Reduction
42.4 – 88.9 1½ – 3	50%
114.3 – 610.0 4 – 24	25%

## Misalignment and Deflection

Tech Data Sheets: TFP1800, G820, G830

GRINNELL Flexible Couplings provide for restrained joints and allow for deflection to aid where the pipe or equipment is misaligned.

Note that flexible couplings will not accommodate both full maximum linear movement and the maximum available angular deflection concurrently at the same joint.

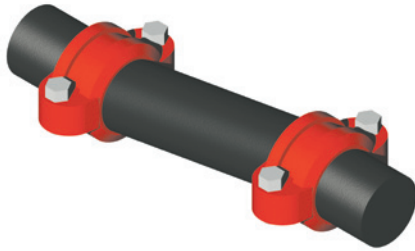

If it is desired to have both deflection and linear movement available, then the system should have sufficient flexible joints to accommodate the requirement.

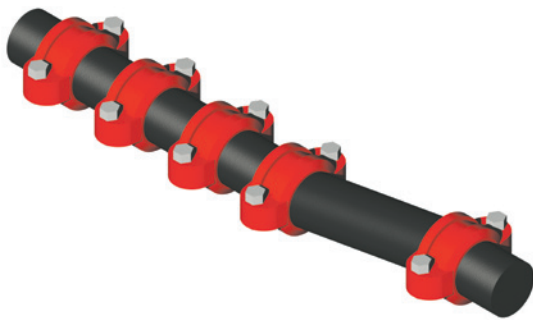

Flexible couplings are also useful in laying out curved piping systems.

$$R = \frac{L}{(2) \left(\sin \frac{\phi}{2}\right)}$$

$$L = (2) (R) \left(\sin \frac{\phi}{2}\right)$$

$$N = \frac{T}{\phi}$$

R = Radius of curve

L = Pipe length

$\phi$  = Deflection from centreline, in degrees, for each coupling (see table)

N = Number of flexible couplings needed

T = Total deflection, in degrees, required

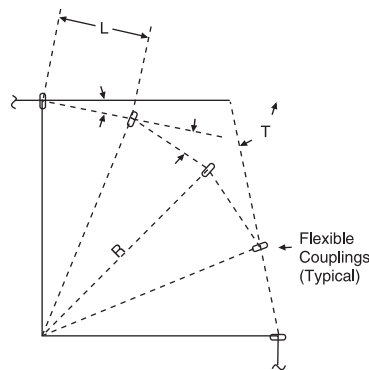

### Design Deflection for Roll Grooved Pipe

Deflection $\phi$ (Roll Grooved Pipe)	
Pipe Size Inches mm	Figures 705 & 707
42.4 1-1/4	1.08°
48.3 1-1/2	0.94°
60.3 2	0.75°
73.0 2-1/2	0.62°
76.1mm —	0.60°
88.9 3	0.51°
114.3 4	1.19°
141.3 5	0.97°
165.1mm —	0.83°
168.3 6	0.81°
219.1 8	0.63°
273.0 10	0.50°
323.9 12	0.42°

Incorporates the recommended safety factor reduction for field practises (50% for sizes 32mm - 80mm (1¼ - 3") and 25% for sizes 100mm - 300mm (4 - 12")).

## Pipe Support

All piping systems require that the support system accommodate the weight of the pipe, joint connections, fluid, and other system components. In addition, consideration may be necessary in reducing stresses, accommodating thermal expansion or contraction, building settlement, seismic movement, etc. The following tables provide guidelines for grooved steel piping products without concentrated loads between supports.

### Flexible Joints

For pipe runs when linear movement is accommodated by the flexible coupling:

Number of Hangers Per Pipe Length								
Pipe Size mm Inches	Pipe Length in Metres Feet							
	3.3	3.7	4.6	6.7	7.6	9.1	10.7	12.2
	10	12	15	22	25	30	35	40
Average Number of Hangers Per Pipe Length								
42.4 – 60.3 1-1/4 - 2	2	2	2	3	4	4	5	6
73.0 – 114.3 2-1/2 - 4	1	2	2	2	2	3	4	4
141.3 – 609.6 5 - 24	1	1	2	2	2	3	3	3

For pipe runs when linear movement is not required:

Distance Between Supports	
Nominal Size mm Inches	Maximum Distance Between Supports Metres Feet
42.4 - 48.3 1-1/4 - 1-1/2	3.7 12
60.3 - 219.1 2 - 8	4.6 15
273.0 - 323.9 10 - 12	4.9 16

**Note:** The requirements of ANSI, ASME or other code groups may require additional supports.

### Rigid Joints

For pipe runs with rigid couplings:

Pipe Size		Suggested Maximum Span Between Supports – Metres Feet					
Nominal DN In.	O.D. mm In.	Water Service			Air Service		
		I	II	III	I	II	III
25	33.4	2.1	2.7	3.7	2.7	9	3.7
1	1.315	7	9	12	9	2.7	12
32	42.4	2.1	3.4	3.7	2.7	11	3.7
1-1/4	1.660	7	11	12	9	3.4	12
40	48.3	2.1	3.7	4.6	2.7	13	4.6
1-1/2	1.900	7	12	15	9	4.0	15
50	60.3	3.0	4.0	4.6	4.0	15	4.6
2	2.375	10	13	15	13	4.6	15
65	73.0	3.4	4.3	4.6	4.3	16	4.6
2-1/2	2.875	11	14	15	14	4.9	15
65	76.1	3.4	4.3	4.6	4.3	16	4.6
76,1mm	3.000	11	14	15	14	4.9	15
80	88.9	3.7	4.6	4.6	4.6	17	4.6
3	3.500	12	15	15	15	5.2	15
100	114.3	4.3	5.2	4.6	5.2	21	4.6
4	4.500	14	17	15	17	6.4	15
125	133.0	4.9	5.8	4.6	6.1	24	4.6
133,0mm	5.236	16	19	15	20	7.3	15
125	139.7	4.6	5.5	4.6	5.2	23	4.6
139,7mm	5.500	15	18	15	19	7	15
125	141.3	4.9	5.8	4.6	6.1	24	4.6
5	5.563	16	19	15	20	7.3	15
150	165.1	5.2	6.1	4.6	6.4	25	4.6
165,1mm	6.500	17	20	15	21	7.6	15
150	168.3	5.2	6.1	4.6	6.4	25	4.6
6	6.625	17	20	15	21	7.6	15
200	219.1	5.8	6.4	4.6	7.3	28	4.6
8	8.625	19	21	15	24	8.5	15
250	273.0	5.8	6.4	4.6	7.3	31	4.6
10	10.750	19	21	15	24	9.4	15
300	323.9	7	6.4	4.6	9.1	33	4.6
12	12.750	23	21	15	30	10.1	15

I - Spacing by ANSI B31.1 Power Piping Code  
 II - Spacing by ANSI B39.1 Building Piping Code  
 III - Spacing by NFPA 13 Sprinkler Systems (Steel Pipe except Threaded Lightwall)

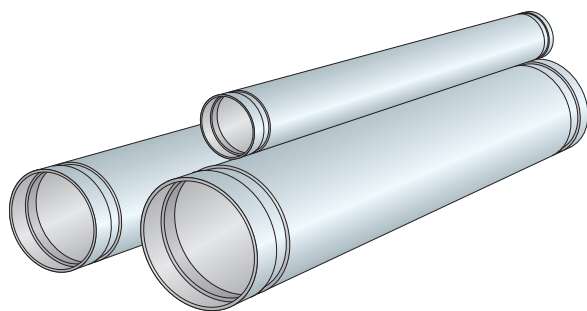

## Pipe Support

*Tech Data Sheets: TFP1800, G820, G830*

### Rotational Movement

GRINNELL Flexible Couplings are suitable for use in seismic as well as mining applications. The inherent capability of the flexible coupling to allow for linear movement, angular deflection, and rotational movement make it an excellent choice for reducing stresses in a piping system and to increase pipe life in slurry applications.

For mining applications where the pipe needs to be rotated, the system should be depressurized. The pipe coupling bolts/nuts can be loosened, pipe rotated, the bolts/nuts re-tightened, and the system be put back in service.

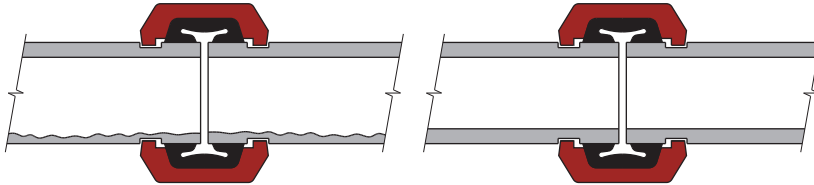

Even distribution of pipe wear can be achieved with this method on the inner service of the pipe.

**Note:** Precautions are necessary to monitor pipe wall thickness to evaluate pressure capability of the pipe with reduced wall.

### Linear Movement

Flexible couplings are designed with the couplings keys engaging the pipe without gripping on the bottom of the groove while still providing for a restrained mechanical joint.



The inherent flexibility of the coupling must be considered when deciding on support arrangements for the piping system as movement can occur in more than one plane (linear movement, angular deflection, and rotational movement).

Upon system pressurization, each pipe end within the flexible couplings will expand to the maximum published value. The coupling keys make contact with the face of the groove and restrain the joint. In piping systems, this movement will be accumulative.

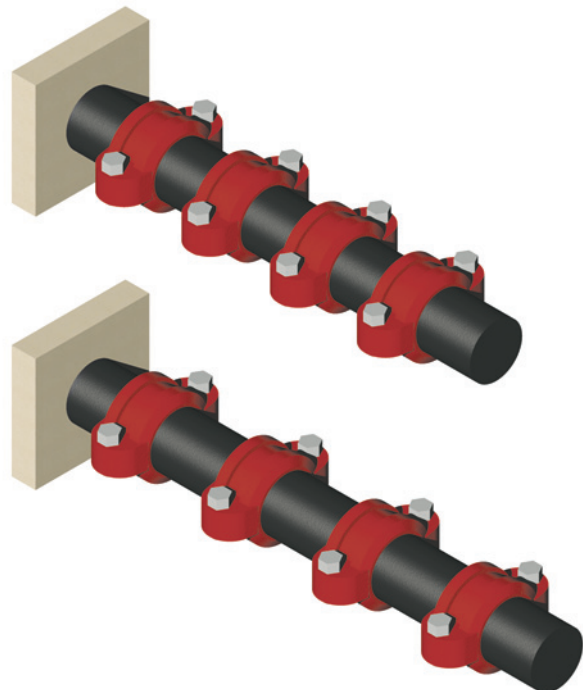

## Pipe Support

Tech Data Sheets: TFP1800, G820, G830

### Angular Movement

System movement can be accommodated by providing for sufficient offset lengths. Temperature increases/decreases can further increase this movement.

When systems are anchored with partially deflected joints, the system can move to the fully deflected condition upon pressurization resulting in the “snaking” of the piping system. Lightweight hangers may not be suitable to prevent the lateral motion.

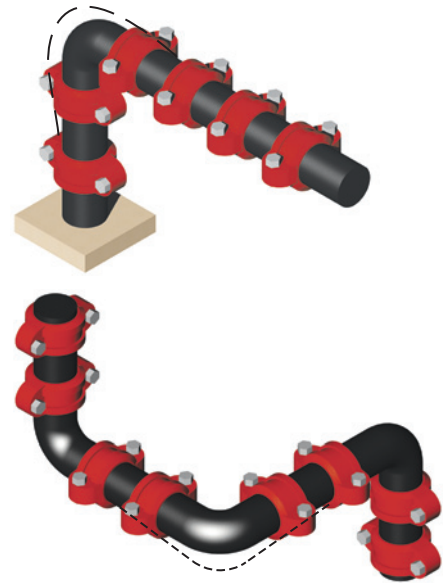

### Pipe Support

Pipe hanger positioning is important when considering pipe “sagging” due to the flexible nature of the piping system. Proper positioning of hangers near the elbow, for example, should be considered.

The use of spring hangers or other methods can be considered to accommodate vibrations. Base supports, pressure thrust anchors, and pipe offsets can be used to direct pipe movement.

The use of rigid couplings can be considered to reduce the movement available with flexible couplings. Consideration of other methods of accommodation of pipe movements may be required.

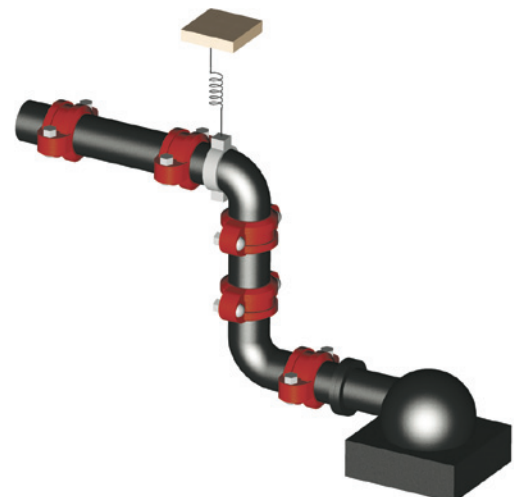
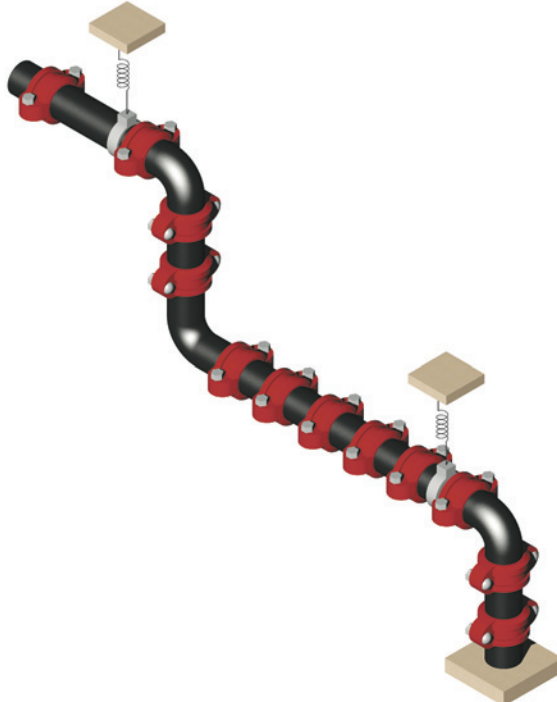
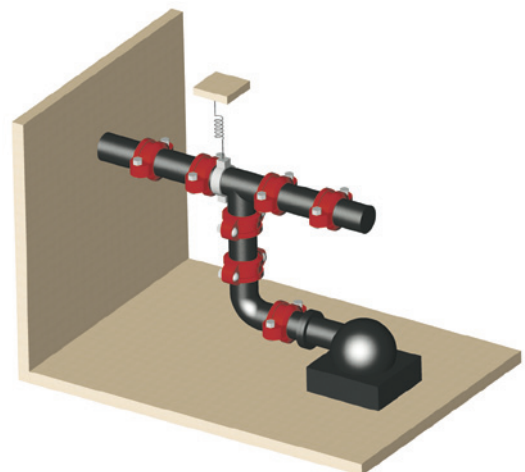

## Vertical Piping

Tech Data Sheets: TFP1800, G820, G830

Risers comprised of rigid couplings can be considered instead of welded or flanged systems. Where thermal movement exists, expansion joints and/or flexible couplings with offsets may be required.

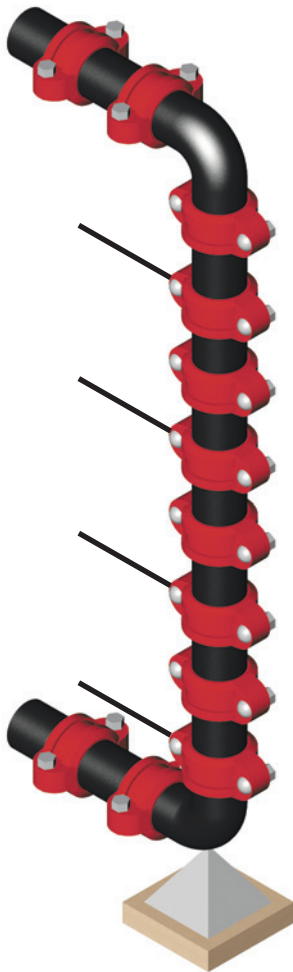

When using flexible couplings, the movement that occurs in long lengths of piping needs to be considered. Each joint can move up to the maximum pipe end separation published. This movement can accumulate and result in the growth of the piping system, for example at the top. Offsets may be necessary.

Should the riser contain branch connections, the movement which occurs at these locations with flexible couplings will also need to be considered.

One solution would be to anchor the vertical piping at appropriate locations to prevent movement which can cause stresses at the branches or equipment. The use of rigid couplings can be an advantage.

As always, good piping practice should prevail. It is the designer's responsibility to select products suitable for the intended service and to ensure that pressure ratings and performance data is not exceeded. Never remove any piping component or correct or modify any piping deficiencies without first depressurizing and draining the system. Material and gasket selection should be verified to be compatible for the specific application.

## Flange Drilling Specifications

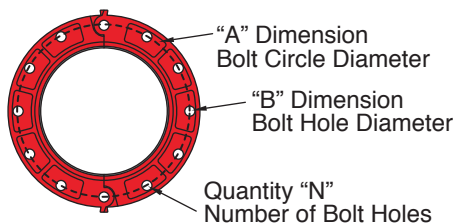

Valve Size		ANSI B16.1 (Class 125#) <sup>1</sup>			ISO 2084 (PN10) <sup>2</sup>			ISO 2084 (PN16) <sup>3</sup>			JIS B 2210 (10K)			AS 2129 (Table E)		
Nominal mm Inches	O.D. mm Inches	Dimensions - mm Inches														
		A	B	Qty. N	A	B	Qty. N	A	B	Qty. N	A	B	Qty. N	A	B	Qty. N
50 2	60.3 2.375	120.6 4.75	19.0 0.75	4	125.0 4.92	18.0 0.71	4	125.0 4.92	18.0 0.71	4	120.0 4.72	19.0 0.75	4	114.0 4.49	18.0 0.71	4
65 2-1/2	73.0 2.875	139.7 5.50	19.0 0.75	4	145.0 5.71	18.0 0.71	4	145.0 5.71	18.0 0.71	4	140.0 5.51	19.0 0.75	4	127.0 5.00	18.0 0.71	4
80 3	88.9 3.500	152.4 6.00	19.0 0.75	4	160.0 6.30	18.0 0.71	8	160.0 6.30	18.0 0.71	8	150.0 5.91	19.0 0.75	8	146.0 5.75	18.0 0.71	4
100 4	114.3 4.500	190.5 7.50	19.1 0.75	8	180.0 7.09	18.0 0.71	8	180.0 7.09	18.0 0.71	8	175.0 6.89	19.0 0.75	8	178.0 7.00	18.0 0.71	8
125 5	141.3 5.563	215.9 8.50	22.4 0.88	8	210.0 8.27	18.0 0.71	8	210.0 8.27	18.0 0.71	8	210.0 8.27	23.0 0.91	8	210.0 8.27	18.0 0.71	8
150 6	168.3 6.625	241.3 9.50	22.4 0.88	8	240.0 9.45	22.0 0.87	8	240.0 9.45	22.0 0.87	8	240.0 9.45	23.0 0.91	8	235.0 9.25	22.0 0.87	8
200 8	219.1 8.625	298.5 11.75	22.2 0.88	8	295.0 11.61	22.0 0.87	8	295.0 11.61	22.0 0.87	12	290.0 11.42	23.0 0.91	12	292.0 11.50	22.0 0.87	8
250 10	273.0 10.750	362.0 14.25	25.4 1.00	12	350.0 13.78	22.0 0.87	12	355.0 13.98	26.0 1.02	12	355.0 13.98	22.0 0.87	12	356.0 14.02	22.0 0.87	12
300 12	323.9 12.750	431.8 17.00	25.4 1.00	12	400.0 15.75	22.0 0.87	12	410.0 16.14	26.0 1.02	12	400.0 15.75	25.0 0.98	16	406.0 15.98	26.0 1.02	12

<sup>1</sup> Same drilling as for B16.5 (Class 150#) and B16.42 (Class 250#)  
<sup>2</sup> Same drilling as for BS 4504 Section 3.2 (PN10) and DIN 2532 (PN10)  
<sup>3</sup> Same drilling as for BS 4504 Section 3.2 (PN16) and DIN 2532 (PN16)  
 For additional information, contact GRINNELL Products.

## Metric/Imperial Conversion Chart

This chart is provided as a guide for converting metric and imperial and measurements.

Convert Metric to Imperial			Convert Imperial to Metric		
MilliMetres (mm)	X	0.03937	Inches (in)	X	25.4
Metres (m)	X	3.281	Feet (ft)	X	0.3048
Kilogrammes (kg)	X	2.205	Pounds (lb)	X	0.4536
Grammes (g)	X	0.03527	Ounces (oz)	X	28.35
Kilopascals (kPa)	X	0.145	Pressure (psi)	X	6.894
Bar	X	14.5	Pressure	X	.069
Newtons (N)	X	0.2248	End Load (lb)	X	4.45
Newton Metres (N•m)	X	0.738	Torque (lbft)	X	1.356
Celsius (°C)		C + 17.78 × 1.8	Temp. (°F)		F - 32 ÷ 1.8
Watts (w)	X	1.341 × 10 <sup>-3</sup>	Horsepower (hp)	X	745.7
Litres per min. (L/M)	X	0.2642	Gal. per Min. (gpm)	X	3.785
Cubic Metres per min. (m3/m)	X	264.2	10 <sup>-3</sup> Gal. per Min. (gpm)	X	3.7865



## Pipe Conversion Table Wall Thickness

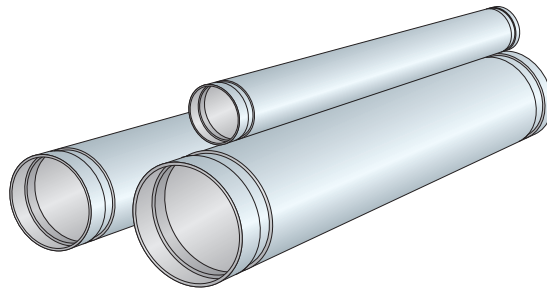

Pipe Size		Conversion Table Wall Thickness - mm inches								
Nominal DN In.	O.D. mm In.	Pipe ANSI B36.10						Pipe DIN Norm		
		Sch. 5	Sch. 10	Sch. 20	Sch. 30	Sch. 40	Sch. 80	DIN 2440	DIN 2448	DIN 2458
<b>20</b>	<b>26.9</b>	<b>1.65</b>	<b>2.77</b>	–	–	<b>2.87</b>	<b>3.91</b>	<b>2.65</b>	<b>2.3</b>	<b>2</b>
¾	1.050	0.06	0.11	–	–	0.11	0.15	0.10	0.09	0.08
<b>25</b>	<b>33.4</b>	<b>1.65</b>	<b>2.77</b>	–	–	<b>3.38</b>	<b>4.55</b>	<b>3.25</b>	<b>2.6</b>	<b>2</b>
1	1.315	0.06	0.11	–	–	0.13	0.18	0.13	0.10	0.08
<b>32</b>	<b>42.4</b>	<b>1.65</b>	<b>2.77</b>	–	–	<b>3.56</b>	<b>4.83</b>	<b>3.25</b>	<b>2.6</b>	<b>2.3</b>
1¼	1.660	0.06	0.11	–	–	0.14	0.19	0.13	0.10	0.09
<b>40</b>	<b>48.3</b>	<b>1.65</b>	<b>2.77</b>	–	–	<b>3.68</b>	<b>5.08</b>	<b>3.25</b>	<b>2.6</b>	<b>2.3</b>
1½	1.900	0.06	0.11	–	–	0.14	0.20	0.13	0.10	0.09
<b>50</b>	<b>60.3</b>	<b>1.65</b>	<b>2.77</b>	–	–	<b>3.91</b>	<b>5.54</b>	<b>3.65</b>	<b>2.9</b>	<b>2.6</b>
2	2.375	0.06	0.11	–	–	0.15	0.22	0.14	0.11	0.10
<b>65</b>	<b>73.0</b>	<b>2.11</b>	<b>3.05</b>	–	–	<b>5.16</b>	<b>7.01</b>	–	–	–
2½	2.875	0.08	0.12	–	–	0.20	0.28	–	–	–
<b>65</b>	<b>76.1</b>	–	–	–	–	–	–	<b>3.65</b>	<b>2.9</b>	<b>2.6</b>
76,1mm	3.000	–	–	–	–	–	–	0.14	0.11	0.10
<b>80</b>	<b>88.9</b>	<b>2.11</b>	<b>3.05</b>	–	–	<b>5.49</b>	<b>7.61</b>	<b>4.05</b>	<b>3.2</b>	<b>2.9</b>
3	3.500	0.08	0.12	–	–	0.22	0.30	0.16	0.13	0.11
<b>100</b>	<b>108,0</b>	–	–	–	–	–	–	–	<b>3.6</b>	<b>2.9</b>
108.0mm	4.252	–	–	–	–	–	–	–	0.14	0.11
<b>100</b>	<b>114.3</b>	<b>2.11</b>	<b>3.05</b>	–	–	<b>6.02</b>	<b>8.56</b>	<b>4.5</b>	<b>3.6</b>	<b>3.2</b>
4	4.500	0.08	0.12	–	–	0.24	0.34	0.18	0.14	0.13
<b>125</b>	<b>133.0</b>	–	–	–	–	–	–	–	<b>4</b>	<b>3.6</b>
133.0mm	5.236	–	–	–	–	–	–	–	0.16	0.14
<b>125</b>	<b>139.7</b>	–	–	–	–	–	–	<b>4.85</b>	–	–
139,7mm	5.500	–	–	–	–	–	–	0.19	–	–
<b>125</b>	<b>141.3</b>	<b>2.77</b>	<b>3.4</b>	–	–	<b>6.55</b>	<b>9.53</b>	–	–	–
5	5.563	0.11	0.13	–	–	0.26	0.38	–	–	–
<b>150</b>	<b>159.0</b>	–	–	–	–	–	–	–	<b>4.5</b>	<b>4</b>
159.0mm	6.260	–	–	–	–	–	–	–	0.18	0.16
<b>150</b>	<b>165.1</b>	–	–	–	–	–	–	<b>4.85</b>	<b>4.5</b>	<b>4</b>
165,1mm	6.500	–	–	–	–	–	–	0.19	0.18	0.16
<b>150</b>	<b>168.3</b>	<b>2.77</b>	<b>3.4</b>	–	–	<b>7.11</b>	<b>10.97</b>	–	–	<b>4.5</b>
6	6.625	0.11	0.13	–	–	0.28	0.43	–	–	0.18
<b>200</b>	<b>219.1</b>	<b>2.77</b>	<b>3.76</b>	<b>6.35</b>	<b>7.04</b>	<b>8.18</b>	<b>12.7</b>	–	<b>6.3</b>	<b>4.5</b>
8	8.625	0.11	0.15	0.25	0.28	0.32	0.50	–	0.25	0.18
<b>250</b>	<b>273.0</b>	<b>3.4</b>	<b>4.19</b>	<b>6.35</b>	<b>7.8</b>	<b>9.27</b>	<b>15.06</b>	–	<b>6.3</b>	<b>5</b>
10	10.750	0.13	0.16	0.25	0.31	0.36	0.59	–	0.25	0.20
<b>300</b>	<b>323.9</b>	<b>3.96</b>	<b>4.57</b>	<b>6.35</b>	<b>8.38</b>	<b>10.31</b>	<b>17.45</b>	–	<b>7.1</b>	<b>5.6</b>
12	12.750	0.16	0.18	0.25	0.33	0.41	0.69	–	0.28	0.22

## Global Pipe Size Designations

GRINNELL product data is utilised worldwide and all technical data is shown in both metric and imperial terms. The following chart shows a comparison between typical metric and IPS pipe sizes.

Nominal Size (DN)		Outside Diameter (OD)								
mm (Metric)	Inches (Imperial)	mm (Specification Reference)	DIN mm	BS mm	ISO mm	JIS mm	ANSI Inches	GB China mm	India	
									IS 1239	IS3589
15	1/2	21.3mm	DN 15	DN 15	DN 15	21.7mm	1/2	DN 15	DN 15	-
20	3/4	26.7mm	26.9mm	DN 20	DN 20	27.2mm	3/4	DN 20	DN 20	-
25	1	33.4mm	33.7mm	DN 25	DN 25	34mm	1	DN 25	DN 25	-
32	1-1/4	42.2mm	42.4mm	DN 32	DN 32	42.7mm	1-1/4	DN 32	DN 32	-
40	1-1/2	48.3mm	DN 40	DN 40	DN 40	48.6mm	1-1/2	DN 40	DN 40	-
50	2	60.3mm	DN 50	DN 50	DN 50	60.5mm	2	DN 50	DN 50	-
65	2-1/2	73.1mm	-	-	-	-	2-1/2	-	-	-
		76.1mm BS/ISO	76.1mm	76.1mm	76.1mm	76.3mm	-	76.1mm **	76.1mm	-
80	3	88.9mm	DN 80	DN 80	DN 80	DN 80	3	DN 80	DN 80	-
90	3-1/2	101.6mm	-	-	-	-	-	-	-	-
100	4	108mm China (& old DIN)	DIN 133mm	-	-	-	-	108mm **	-	-
		114.3mm	DN 100	DN 100	DN 101	DN 100	4	DN 100	DN 100	-
127mm	-	127mm	-	-	-	-	-	-	-	-
125	5	133mm China	-	-	-	-	-	133mm **	-	-
		139.7mm BS/ISO	DN 125	139.7mm	139.7mm	139.8mm	-	139.7mm	139.7mm	-
		141.3mm	-	-	-	-	5	-	-	-
152.4mm	-	152.4mm	-	-	-	-	-	-	-	
150	6	159mm China	-	-	-	-	-	159mm	-	-
		165.1mm JIS/BS	-	165.1mm	-	165.2mm	-	-	165.1mm	-
		168.3mm	DN 150	-	DN 150	-	6	DN 150	-	DN 150
175	-	193.7mm	-	-	-	-	-	-	193.7mm	
203.2mm	-	203.2mm	-	-	-	-	-	-	-	
200	8	216.3mm JIS	-	-	-	216.3mm	-	-	-	-
		219.1mm	DN 200	DN 200	DN 200	-	8	DN 200	DN 200	DN 200
254mm	-	254mm	-	-	-	-	-	-	-	
250	10	267.4mm JIS	-	-	-	267.4mm	-	-	-	-
		273mm	DN 250	DN 250	DN 250	-	10	DN 250	DN 250	DN 250
304.8mm	-	304.8mm	-	-	-	-	-	-	-	
300	12	318.5mm JIS	-	-	-	318.5mm	-	-	-	-
		323.9mm	DN 300	DN 300	DN 300	-	12	-	-	-

### IMPORTANT NOTE:

Nominal designations are used where the actual OD of the pipe matches the ANSI size. Otherwise both the nominal and actual OD are listed.







China sizes are listed as actual OD in mm.

\*\* China sizes are tubing sizes.

## Listing and Approval Information

(Page 1 of 8)

Tech Data Sheets: TFP1800



Figure	Nominal Size mm Inches	Pipe Schedule	Rated Pressure - Bar <i>psi</i> (UL, ULC, FM, LPCB, and VdS)					
								
 Fig. 577	42.4, 48.3, 60.3 1/4, 1/2, 2	FLF, MF, XL, GL, 10, 40, CT, DF, TL, WLS, MT, MLT	20.7 300	20.7 300	20.7 300	-	-	
	73.0, 88.9, 114.3 2 1/2, 3, 4	FLF, MF, DF	20.7 300	20.7 300	20.7 300	-	-	
	73.0, 88.9 2 1/2, 3	FF, XL	20.7 300	20.7 300	20.7 300	-	-	
	42.4, 48.3, 60.3, 73.0, 88.9, 114.3, 168.3, 219.1 1/4, 1/2, 2, 2 1/2, 3, 4, 6, 8	10	20.7 300	20.7 300	20.7 300	-	-	
	42.4, 48.3, 60.3, 73.0, 88.9, 114.3, 168.3 1/4, 1/2, 2, 2 1/2, 3, 4, 6	40	20.7 300	20.7 300	20.7 300	-	-	
	33.7, 42.4, 48.3, 60.3 1, 1/4, 1/2, 2	5	12.1 175	12.1 175	12.1 175	-	-	
	88.9, 114.3, 168.3 3, 4, 6	EZF	20.7 300	20.7 300	20.7 300	-	-	
	42.4 1/4	EZT	20.7 300	20.7 300	20.7 300	-	-	
	48.3, 60.3 1/2, 2	EZT, FF	20.7 300	20.7 300	20.7 300	-	-	
	48.3, 60.3, 73.0, 88.9, 114.3 1/2, 2, 2 1/2, 3, 4	STF	20.7 300	20.7 300	20.7 300	-	-	
	114.3 4	STF	17.2 250	17.2 250	17.2 250	-	-	
	219.1 8	0.188 in. wall	20.7 300	20.7 300	20.7 300	-	-	
	33.7 1	10, 40, XL, TL, DF, BLT, DL, DT, MT, WLS, WST, GL, MLT, EZT, ET, EL, 5, BS1387M, ISO 4200	20.7 300	20.7 300	20.7 300	-	-	
	141.3 5	10, 40	20.7 300	20.7 300	20.7 300	-	-	
	76.1mm, 165mm 76.1mm, 165.1mm	BS1387M, ISO 4200	20.7 300	-	20.7 300	-	-	
	139.7mm 139.7mm	ISO 4200	20.7 300	-	20.7 300	-	-	
	33.7, 42.4, 48.3, 60.3, 76.1, 88.9, 114.3, 165.1 1, 1/4, 1/2, 2, 76.1mm, 3, 4, 165.1mm	BS1387M, ISO 4200	-	-	-	-	20.7 300	
	168.3, 219.1 6, 8	ISO 4200	-	-	-	-	20.7 300	
	33.7, 42.4, 48.3, 60.3, 88.9, 114.3, 168.3, 219.1 1, 1/4, 1/2, 2, 3, 4, 6, 8	ISO 4200	-	-	-	-	16 232	
	76.1, 139.7 76.1mm, 139.7mm	ISO 4200	-	-	-	-	16 232	
	 Fig. 705	42.4, 48.3, 60.3 1/4, 1/2, 2	Sch 5, ID, WST	12.1 175	12.1 175	12.1 175	-	-
		42.4, 48.3, 60.3, 73.0 1/4, 1/2, 2, 2 1/2	Sch 10, Sch 40	20.7 300	20.7 300	20.7 300	-	-
		88.9, 114.3, 141.3, 168.3, 219.1 3, 4, 5, 6, 8	Sch 10, Sch 40	20.7 300	20.7 300	20.7 300	-	-
273.0, 323.9 10, 12		Sch 10, Sch 40	17.2 250	17.2 250	17.2 250	-	-	
42.4, 48.3, 60.3, 73.0, 88.9 1/4, 1/2, 2, 2 1/2, 3		MF	20.7 300	20.7 300	20.7 300	-	-	
114.3 4		MF	-	-	20.7 300	-	-	
42.4, 48.3, 60.3, 73.0, 88.9, 114.3 1/4, 1/2, 2, 2 1/2, 3, 4		DF	20.7 300	20.7 300	20.7 300	-	-	
42.4, 48.3, 60.3, 73.0, 88.9, 114.3 1/4, 1/2, 2, 2 1/2, 3, 4		FLF	20.7 300	20.7 300	-	-	-	

Pressure &amp; Design Data

## Listing and Approval Information

(Page 2 of 8)

Tech Data Sheets: TFP1800

Figure	Nominal Size mm Inches	Pipe Schedule	Rated Pressure - Bar <i>psi</i> (UL, ULC, FM, LPCB, and VdS)					
			UL	ULC	FM	VdS	LPCB	
 Fig. 705 (Cont.)	48.3, 60.3, 73.0, 88.9, 114.3 1½, 2, 2½, 3, 4	FF	20.7 300	20.7 300	20.7 300	-	-	
	33.7, 42.4, 48.3, 60.3 1, 1¼, 1½, 2	MLT, EZT	20.7 300	20.7 300	20.7 300	-	-	
	88.9 3	EZ	20.7 300	20.7 300	20.7 300	-	-	
	114.3 4	EZ	17.2 250	17.2 250	20.7 300	-	-	
	168.3 6	EZ	17.2 250	17.2 250	12.1 175	-	-	
	42.4, 48.3, 60.3 1¼, 1½, 2	BLT, DT, TL, Gal 7, Gal Flo	20.7 300	20.7 300	20.7 300	-	-	
	42.4, 48.3, 60.3 1¼, 1½, 2	GL, MLT, MT, SL, WLS	20.7 300	20.7 300	-	-	-	
	42.4, 48.3, 60.3 1¼, 1½, 2	UE	-	-	12.1 175	-	-	
	76.1, 165.1 76.1mm, 165.1mm	BS1387	20.7 300	20.7 300	20.7 300	-	-	
	42.4, 48.3, 60.3, 76.1, 88.9, 114.3 1¼, 1½, 2, 76.1mm, 3, 4	BS1387, ISO 4200	-	-	-	16 232	20.7 300	
	139.7 139.7mm	BS1387, ISO 4200	-	-	-	16 232	-	
	165.1 165.1mm	BS1387, ISO 4200	-	-	-	-	20.7 300	
	168.3, 219.1 6, 8	ISO 4200	-	-	-	16 232	20.7 300	
	108.0, 133.0, 159.0 108.0mm, 133.0mm, 159.0mm	ISO 4200	20.7 300	-	20.7 300	-	-	
	 Fig. 707	48.3, 60.3, 73.0 1½, 2, 2½	Sch 5, UE, WST	12.1 175	12.1 175	12.1 175	-	-
		48.3, 60.3, 73.0, 88.9, 114.3, 141.3 1½, 2, 2½, 3, 4, 5	Sch 10	31.0 450	31.0 450	31.0 450	-	-
		168.3, 219.1, 273.0, 323.9 6, 8, 10, 12	Sch 10	31.0 450	31.0 450	31.0 450	-	-
48.3, 60.3, 73.0, 88.9, 114.3, 141.3 1½, 2, 2½, 3, 4, 5		Sch 40	34.5 500	34.5 500	34.5 500	-	-	
168.3, 219.1, 273.0, 323.9 6, 8, 10, 12		Sch 40	34.5 500	34.5 500	34.5 500	-	-	
48.3, 60.3, 73.0, 88.9, 114.3 1½, 2, 2½, 3, 4		MF, DF, FF, SF, STF	20.7 300	20.7 300	20.7 300	-	-	
60.3 2		EZT	20.7 300	-	-	-	-	
88.9 3		EZ	20.7 300	20.7 300	20.7 300	-	-	
114.3 4		EZ	17.2 250	17.2 250	20.7 300	-	-	
168.3 6		EZ	17.2 250	17.2 250	12.1 175	-	-	
48.3, 60.3, 73.0, 88.9 1½, 2, 2½, 3		XL	20.7 300	20.7 300	20.7 300	-	-	
48.3, 60.3 1½, 2		GL, MT, MLT, TL	20.7 300	20.7 300	20.7 300	-	-	
48.3, 60.3 1½, 2		Gal 7, Gal Flo	20.7 300	20.7 300	20.7 300	-	-	
48.3, 60.3 1½, 2		BLT, DT	-	-	20.7 300	-	-	
76.1, 165.1 76.1mm, 165.1mm		BS1387, ISO 4200	20.7 300	-	20.7 300	-	20.7 300	

## Listing and Approval Information

(Page 3 of 8)

Tech Data Sheets: TFP1800

Figure	Nominal Size mm Inches	Pipe Schedule	Rated Pressure - Bar psi (UL, ULC, FM, LPCB, and VdS)				
			UL	ULC	FM	VdS	LPCB
Fig. 707 (cont.)	48.3, 60.3, 88.9, 114.3, 168.3 1½, 2, 3, 4, 6	BS1387, ISO 4200	-	-	-	-	20.7 300
	219.1, 273.0, 323.9 8, 10, 12	ISO 4200	-	-	-	16 232	20.7 300
	60.3 x 48.3, 73.0 x 60.3, 88.9 x 60.3 2 x 1½, 2½ x 2, 3 x 2	Sch 5	12.1 175	12.1 175	12.1 175	-	-
88.9 x 73.0, 114.3 x 60.3, 114.3 x 73.0 3 x 2½, 4 x 2, 4 x 2½	Sch 5	12.1 175	12.1 175	12.1 175	-	-	
60.3 x 48.3, 73.0 x 60.3, 88.9 x 60.3 2 x 1½, 2½ x 2, 3 x 2	Sch 10, Sch 40	24.1 350	24.1 350	24.1 350	-	-	
88.9 x 73.0, 114.3 x 60.3, 114.3 x 73.0 3 x 2½, 4 x 2, 4 x 2½	Sch 10, Sch 40	24.1 350	24.1 350	24.1 350	-	-	
114.3 x 88.9, 141.3 x 114.3, 168.3 x 114.3, 141.3 4 x 3, 5 x 4, 6 x 4, 5	Sch 10, Sch 40	24.1 350	24.1 350	20.7 300	-	-	
219.1 x 168.3 8 x 6	Sch 40	24.1 350	24.1 350	20.7 300	-	-	
60.3 x 48.3, 73.0 x 60.3, 88.9 x 60.3 2 x 1½, 2½ x 2, 3 x 2	DF, EZT, FF, GL, MF, MT, MLT, SF, STF, TL	20.7 300	20.7 300	20.7 300	-	-	
114.3 x 60.3 4 x 2	DF, EZT, FF, GL, MF, MT, MLT, SF, STF, TL	20.7 300	20.7 300	20.7 300	-	-	
88.9 x 73.0, 114.3 x 73.0, 114.3 x 88.9 3 x 2½, 4 x 2½, 4 x 3	DF, MF, SF	20.7 300	20.7 300	20.7 300	-	-	
114.3 x 73.0, 114.3 x 88.9 4 x 2½, 4 x 3	FF, STF	20.7 300	20.7 300	20.7 300	-	-	
141.3 x 114.3, 168.3 x 114.3 5 x 4, 6 x 4	DF, FF, SF, STF	20.7 300	20.7 300	20.7 300	-	-	
88.9 x 60.3, 88.9 x 73.0 3 x 2, 3 x 2½	EZ	20.7 300	20.7 300	20.7 300	-	-	
60.3 x 48.3 2 x 1½	Gal 7, Gal Flo	20.7 300	20.7 300	20.7 300	-	-	
60.3 x 48.3, 73.0 x 60.3, 88.9 x 60.3 2 x 1½, 2½ x 2, 3 x 2	BS1387, ISO 4200	20.7 300	-	20.7 300	16 232	20.7 300	
88.9 x 76.1, 114.3 x 60.3, 76.1, 88.9 3 x 76.1mm, 4 x 2, 76.1mm, 3	BS1387, ISO 4200	20.7 300	-	20.7 300	16 232	20.7 300	
168.3 x 114.3, 219.1 x 168.3 6 x 4, 8 x 6	ISO 4200	20.7 300	-	20.7 300	16 232	20.7 300	
139.7 x 114.3 139.7mm x 4	BS1387, ISO 4200	20.7 300	-	20.7 300	16 232	-	
165.1 x 114.3 165.1mm x 4	BS1387, ISO 4200	20.7 300	-	20.7 300	-	20.7 300	
Fig. 71 (PN16)	60.3, 76.1, 88.9, 114.3, 168.3 2, 76.1mm, 3, 4, 6	BS1387, ISO 4200	17.2 250	-	17.2 250	16 232	20.7 300
	139.7 139.7mm	BS1387, ISO 4200	17.2 250	-	17.2 250	16 232	-
	165.1 165.1mm	BS1387, ISO 4200	17.2 250	-	17.2 250	-	20.7 300
	219.1, 273.0 8, 10	ISO 4200	17.2 250	-	17.2 250	-	20.7 300
	323.9 12	ISO 4200	17.2 250	-	17.2 250	-	16 232
Fig. 71 (ANSI)	60.3 2	Sch 5, ID, UE, WST	12.1 175	12.1 175	12.1 175	-	-
	60.3, 73.0, 88.9, 114.3, 141.3, 168.3, 219.1 2, 2½, 3, 4, 5, 6, 8	Sch 10, Sch 40	17.2 250	17.2 250	17.2 250	-	-
	273.0, 323.9 10, 12	Sch 40	17.2 250	17.2 250	17.2 250	-	-
	60.3 2	BLT, DT, EZT, FF, GL, LS, MT, MLT, TL, WLS, XL, Gal 7, Gal Flo	17.2 250	17.2 250	17.2 250	-	-

Pressure & Design Data

## Listing and Approval Information

(Page 4 of 8)

Tech Data Sheets: TFP1800

Figure	Nominal Size mm Inches	Pipe Schedule	Rated Pressure - Bar psi (UL, ULC, FM, LPCB, and VdS)				
			UL	ULC	FM	VdS	LPCB
 <p><b>Fig. 71 (ANSI) (Cont.)</b></p>	60.3 2	MF, FF	-	-	17.2	-	-
	60.3, 73.0, 88.9, 114.3 2, 2½, 3, 4	DF, FF, MF, SF	17.2	17.2	17.2	-	-
	88.9, 114.3 3, 4	EZ	17.2	17.2	17.2	-	-
	168.3 6	EZ	17.2	17.2	12.1	-	-
	60.3, 88.9, 114.3 2, 3, 4	STF	17.2	17.2	17.2	-	-
	73.0, 88.9 2½, 3	XL	17.2	17.2	17.2	-	-
	33.7, 42.4, 48.3, 60.3, 76.1 x 15, 20, 25 1, 1¼, 1½, 2, & 76.1mm x ½, ¾, 1	a, b, c, d, e, g, h j, l, m, n, p, q, r, s, t, u	-	-	20.7	-	-
42.4 x 10 1¼ x ¾	a, b, c, d, e, g, h j, l, m, n, p, q, r, s, t, u	-	-	20.7	-	-	
33.7, 42.4, 48.3, 60.3, 76.1 x 15, 20, 25 1, 1¼, 1½, 2, & 76.1mm x ½, ¾, 1	c, k	-	-	20.7	-	-	
42.4 x 10 1¼ x ¾	XL, XL-II, DT, CT, SuXL, Su40, DF, EF, SF, BLT, 5, TL, STF, ST, EL, ET40, 10, 40, G7, GF, FLF, FLT, FLTL, WLS, MFGF, GL, MLT, MT, MTGT, EZT	20.7	20.7	-	-	-	
42.4 x 10, 42.4, 48.3, 60.3, 76.1 x 15, 20, 25 1¼ x ¾, 1¼, 1½, 2, & 76.1mm x ½, ¾, 1	EF	12.1	-	-	-	-	
33.7, 42.4, 48.3, 60.3 x 15, 20, 25 1, 1¼, 1½, & 2 x ½, ¾, 1	EF	-	12.1	-	-	-	
33.7, 42.4, 48.3, 60.3, 76.1 x 15, 20, 25 1, 1¼, 1½, 2, & 76.1mm x ½, ¾, 1	10, 40, XL, XL-II, SuXL, Su40, DF, SF, FLF	20.7	-	-	-	-	
33.7, 42.4, 48.3, 60.3 x 15, 20, 25 1, 1¼, 1½, & 2 x ½, ¾, 1	10, 40, XL, XL-II, SuXL, Su40, DF, SF, FLF	-	20.7	-	-	-	
33.7, 42.4, 48.3, 60.3 x 15, 20, 25 1, 1¼, 1½, & 2 x ½, ¾, 1	DT, CT, BLT, TL, STF, ST, EL, ET40, G7, GF, FLT, FLTL, WLS, GL, MLT, MT, MTGT, SL, EZT	20.7	20.7	-	-	-	
33.7, 42.4, 48.3, 60.3 x 15, 20, 25 1, 1¼, 1½, & 2 x ½, ¾, 1	5	12.1	12.1	-	-	-	
76.1 x 15, 20, 25 76.1mm x ½, ¾, 1	TF	20.7	-	-	-	-	
42.4, 48.3, 60.3, 76.1 x 15, 20, 25 1¼, 1½, 2, & 76.1mm x ½, ¾, 1	MF, MFGF	20.7	-	-	-	-	
42.4, 48.3, 60.3 x 15, 20, 25 1¼, 1½, & 2 x ½, ¾, 1	MF, MFGF	-	20.7	-	-	-	
48.3, 60.3, 76.1 x 15, 20, 25 1½, 2, & 76.1mm x ½, ¾, 1	FF	20.7	-	-	-	-	
33.7, 42.4, 48.3, 60.3, 76.1 x 15, 20, 25 1, 1¼, 1½, 2, & 76.1mm x ½, ¾, 1	BS1378M, ISO 4200	20.7	20.7	-	-	-	



- a. Min schedule cut groove pipe: (6") or smaller - Sch. 40.
- b. Min schedule rolled groove pipe: (6") or smaller - Sch. 10.
- c. With EPDM gasket (green stripe) Grade E or (purple stripe) Grade A.
- d. Allied Tube & Conduit Corp Thinwall Pipe, "BLT" and "Dyna-Thread (1-2)", "XL", "XL-II", "Super-XL" and "Super-40" (1-2½") 20.7 Bar (300 psi).
- e. Allied Tube & Conduit Corp Lightwall Pipe, "Dyna-Flow" and "Super-Flu" (1-2½") 20.7 Bar (300 psi).
- f. Allied Tube & Conduit Corp Sch. 5 Pipe, Dyna-Light (1-2") 12.1 Bar (175 psi).
- g. Bull Moose Thinwall Pipe, "EDDY-40" and "EDDY-Thread", (1-2") 20.7 Bar (300 psi).
- h. Bull Moose Sch. 5 Pipe, "Ultra-EDDY" (1-2") 12.1 Bar (175 psi).
- j. Bull Moose Lightwall Pipe, "EDDY-Flu" (1¼ - 2½") 20.7 Bar (300 psi).
- k. BS 1387 pipe, medium and heavy wall and ISO 4200 pipe, (1-2½" (76.1mm)) 20.7 Bar (300 psi).
- l. Welded Tube-Berkeley LLC Lightwall Pipe, Steady-Flow (1¼ - 2½") 20.7 Bar (300 psi).
- m. Welded Tube-Berkeley LLC Thinwall Pipe, Steady-Thread (1¼ - 2") 20.7 Bar (300 psi).
- n. Western International Forest Products Thinwall Pipe, Rapid-Thread and Rapid Thread Light (1-2") 20.7 Bar (300 psi).
- p. Western International Forest Products Lightwall Pipe, Fire-Flow (1-2½") 20.7 Bar (300 psi).
- q. Wheatland Tube Co. Lightwall pipe, "Mega-Flow" (1-2½") 20.7 Bar (300 psi).
- r. Wheatland Tube Co. Thinwall pipe, "WLS", "Mega-Thread", "MLT" "GL" and EZ Thread (1¼ - 2") 20.7 Bar (300 psi).
- s. Wheatland Tube Co Schedule 5 Pipe, pipe, "WST" (1-2") 12.1 Bar (175 psi).
- t. Youngstown Tube Lightwall Pipe, Fire-Flu (1½ - 2½") 20.7 Bar (300 psi).
- u. Youngstown Tube Thinwall Pipe, EZ-Thread (1 - 2") 20.7 Bar (300 psi).

## Listing and Approval Information

(Page 5 of 8)

Tech Data Sheets: TFP1800

Figure	Nominal Size mm Inches	Pipe Schedule	Rated Pressure - Bar psi (UL, ULC, FM, LPCB, and VdS)				
			UL	ULC	FM	VdS	LPCB
 <p><b>Fig. 730</b> Threaded * †</p>	60.3 x 21.3, 26.7, 33.7, 42.4, 48.3 2 x 1/2, 3/4, 1, 1 1/4, 1 1/2	Sch 5	12.1 175	12.1 175	12.1 175	-	-
	60.3 x 21.3, 26.7, 33.7, 42.4, 48.3 2 x 1/2, 3/4, 1, 1 1/4, 1 1/2	Sch 10, Sch 40	20.7 300	20.7 300	20.7 300	-	-
	73.0 x 21.3, 26.7, 33.7, 42.4, 48.3, 60.3 2 1/2 x 1/2, 3/4, 1, 1 1/4, 1 1/2, 2	Sch 10, Sch 40	20.7 300	20.7 300	20.7 300	-	-
	88.9, 114.3 x 21.3, 26.7, 33.7 3, & 4 x 1/2, 3/4, 1	Sch 10, Sch 40	20.7 300	20.7 300	20.7 300	-	-
	114.3 x 73.0, 4 x 88.9 4 x 2 1/2, 4 x 3	Sch 10, Sch 40	20.7 300	20.7 300	20.7 300	-	-
	141.3 x 60.3, 141.3 x 73.0 5 x 2, 5 x 2 1/2	Sch 10, Sch 40	20.7 300	20.7 300	20.7 300	-	-
	168.3 x 48.3, 60.3, 73.0, 88.9, 114.3 6 x 1 1/2, 2, 2 1/2, 3, 4	Sch 10, Sch 40	20.7 300	20.7 300	20.7 300	-	-
	60.3 x 21.3, 26.7, 33.7, 42.4, 48.3 2 x 1/2, 3/4, 1, 1 1/4, 1 1/2	BLT, DT, EZT, FF, GL, MF	20.7 300	20.7 300	20.7 300	-	-
	60.3 x 21.3, 26.7, 33.7, 42.4, 48.3 2 x 1/2, 3/4, 1, 1 1/4, 1 1/2	MT, MLT, STF, TL, WLS	20.7 300	20.7 300	20.7 300	-	-
	60.3 x 21.3, 26.7, 33.7, 42.4, 48.3 2 x 1/2, 3/4, 1, 1 1/4, 1 1/2	Gal 7, Gal Flo	20.7 300	20.7 300	20.7 300	-	-
	60.3 x 21.3, 26.7, 33.7 2 x 1/2, 3/4, 1	DF	20.7 300	20.7 300	20.7 300	-	-
	73.0, 88.9, 114.3 x 21.3, 26.7, 33.7 2 1/2, 3, & 4 x 1/2, 3/4, 1	DF, FF, MF, STF	20.7 300	20.7 300	20.7 300	-	-
	60.3 x 42.4, 48.3 2 x 1 1/4, 1 1/2	DF	20.7 300	20.7 300	20.7 300	-	-
	88.9, 114.3 x 60.3 3, & 4 x 2	DF, FF, MF, STF	20.7 300	20.7 300	20.7 300	-	-
	114.3 x 73.0 4 x 2 1/2	DF, FF, MF, STF	20.7 300	20.7 300	20.7 300	-	-
	114.3 x 88.9 4 x 3	FF, MF, STF	20.7 300	20.7 300	20.7 300	-	-
	76.1 x 21.3, 26.7, 33.7 76.1mm x 1/2, 3/4, 1	BS1387, ISO 4200	20.7 300	-	20.7 300	16 232	20.7 300
	139.7 x 48.3, 88.9 139.7mm x 1 1/2, 3	BS1387, ISO 4200	20.7 300	-	20.7 300	16 232	20.7 300
	165.1 x 42.4 165.1mm x 1 1/4	BS1387, ISO 4200	20.7 300	-	20.7 300	16 232	20.7 300
	60.3 x 21.3, 26.7, 33.7, 42.4, 48.3 2 x 1/2, 3/4, 1, 1 1/4, 1 1/2	BS1387, ISO 4200	-	-	-	16 232	20.7 300
	76.1 x 42.4, 48.3, 60.3 76.1mm x 1 1/4, 1 1/2, 2	BS1387, ISO 4200	-	-	-	16 232	20.7 300
	88.9 x 21.3, 26.7, 33.7, 42.4, 48.3, 60.3 3 x 1/2, 3/4, 1, 1 1/4, 1 1/2, 2	BS1387, ISO 4200	-	-	-	16 232	20.7 300
	114.3 x 21.3, 26.7, 33.7, 42.4, 48.3, 76.1, 88.9 4 x 1/2, 3/4, 1, 1 1/4, 1 1/2, 2, 76.1mm, 3	BS1387, ISO 4200	-	-	-	16 232	20.7 300
	165.1 x 48.3, 60.3, 76.1, 88.9, 114.3 165.1mm x 1 1/2, 2, 76.1mm, 3, 4	BS1387, ISO 4200	-	-	-	-	20.7 300
	139.7 x 60.3, 76.1 139.7mm x 2, 76.1mm	BS1387, ISO 4200	-	-	-	16 232	-
	168.3 x 48.3, 60.3, 73.0 6 x 1 1/2, 2, 2 1/2	ISO 4200	-	-	-	16 232	20.7 300
	168.3, 219.1 x 76.1, 88.9, 114.3 6, & 8 x 76.1mm, 3, 4	ISO 4200	-	-	-	16 232	20.7 300

\* Figure 730 Threaded Mechanical Outlets are UL and ULC Listed and FM Approved in both the Tee and Cross configuration with NPT and ISO threaded outlets as specified in the chart.



\*\* Figure 730 Grooved Mechanical Outlets are UL and ULC Listed and FM Approved in both the Tee and Cross configuration.

† Figure 730 Threaded and Grooved Mechanical Outlets are VdS Approved in the Tee configuration only.

## Listing and Approval Information

(Page 6 of 8)

Tech Data Sheets: TFP1800

Figure	Nominal Size mm Inches	Pipe Schedule	Rated Pressure - Bar psi (UL, ULC, FM, LPCB, and VdS)					
			UL	ULC	FM	VdS	LPCB	
 Fig. 730 Grooved ** †	60.3 x 48.3 2 x 1½	Sch 5	12.1 175	12.1 175	12.1 175	-	-	
	60.3, 73.0, 88.9, 114.3, 141.3, 168.3 x 48.3 2, 2½, 3, 4, 5, & 6 x 1½	Sch 10, Sch 40	20.7 300	20.7 300	20.7 300	-	-	
	88.9, 114.3, 141.3 x 60.3, 73.0 3, 4, & 5 x 2, 2½	Sch 10, Sch 40	20.7 300	20.7 300	20.7 300	-	-	
	114.3 x 88.9, 141.3 x 88.9 4 x 3, 5 x 3	Sch 10, Sch 40	20.7 300	20.7 300	20.7 300	-	-	
	168.3 x 48.3, 73.0, 88.9, 114.3 6 x 1½, 2½, 3, 4	Sch 10, Sch 40	17.2 250	17.2 250	17.2 250	-	-	
	219.1 x 73.0, 88.9, 114.3 8 x 2½, 3, 4	Sch 10, Sch 40	20.7 300	20.7 300	20.7 300	-	-	
	60.3, 73.0, 88.9, 114.3 x 48.3 2, 2½, 3, & 4 x 1½	DF	20.7 300	20.7 300	20.7 300	-	-	
	88.9, 114.3 x 60.3 3, & 4 x 2	DF	20.7 300	20.7 300	20.7 300	-	-	
	60.3 x 48.3 2 x 1½	BLT, TL	20.7 300	20.7 300	20.7 300	-	-	
	88.9 x 48.3 3 x 1½	EZ	20.7 300	20.7 300	20.7 300	-	-	
	139.7 x 48.3, 88.9 139.7mm x 1½, 3	BS1387, ISO 4200	20.7 300	-	20.7 300	16 232	20.7 300	
	165.1 x 42.4, 48.3, 60.3, 76.1 165.1mm x 1¼, 1½, 2, 76.1mm	BS1387, ISO 4200	20.7 300	-	20.7 300	16 232	20.7 300	
	60.3 x 42.4, 48.3 2 x 1¼, 1½	BS1387, ISO 4200	-	-	-	16 232	20.7 300	
	76.1 x 42.4, 48.3, 60.3 76.1mm x 1¼, 1½, 2	BS1387, ISO 4200	-	-	-	16 232	20.7 300	
	88.9 x 42.4, 48.3, 60.3 3 x 1¼, 1½, 2	BS1387, ISO 4200	-	-	-	16 232	20.7 300	
	114.3 x 42.4, 48.3, 60.3, 76.1, 88.9 4 x 1¼, 1½, 2, 76.1mm, 3	BS1387, ISO 4200	-	-	-	16 232	20.7 300	
	165.1 x 48.3, 60.3, 76.1, 88.9, 114.3 165.1mm x 1½, 2, 76.1mm, 3, 4	BS1387, ISO 4200	-	-	-	-	20.7 300	
	139.7 x 60.3, 76.1 139.7mm x 2, 76.1mm	BS1387, ISO 4200	-	-	-	16 232	-	
	168.3 x 48.3, 60.3, 73.0 6 x 1½, 2, 2½	ISO 4200	-	-	-	16 232	20.7 300	
	168.3, 219.1 x 76.1, 88.9, 114.3 6, & 8 x 76.1mm, 3, 4	ISO 4200	-	-	-	-	16 232	
	 Fig. 260	42.4, 48.3, 60.3, 88.9, 114.3 1¼, 1½, 2, 3, 4	-	34.5 500	34.5 500	34.5 500	16 232	20.7 300
		168.3, 219.1 6, 8	-	34.5 500	34.5 500	34.5 500	16 232	20.7 300
		273.0 10	-	31.0 450	31.0 450	31.0 450	16 232	20.7 300
		323.9 12	-	31.0 450	31.0 450	27.6 400	16 232	20.7 300
73.0, 141.3 2½, 5		-	34.5 500	34.5 500	34.5 500	-	-	
76.1 76.1mm		-	34.5 500	-	34.5 500	16 232	20.7 300	
165.1 165.1mm		-	34.5 500	-	34.5 500	-	20.7 300	
139.7 139.7mm		-	34.5 500	-	34.5 500	16 232	-	









Pressure & Design Data



## Listing and Approval Information

(Page 7 of 8)



Tech Data Sheets: TFP1800

Figure	Nominal Size mm Inches	Pipe Schedule	Rated Pressure - Bar psi (UL, ULC, FM, LPCB, and VdS)					
								
 Fig. 250	48.3 x 33.7, 60.3 x 33.7 1 1/2 x 1, 2 x 1	-	34.5 500	34.5 500	34.5 500	16 232	- -	
	60.3 x 42.4, 60.3 x 48.3 2 x 1 1/4, 2 x 1 1/2	-	34.5 500	34.5 500	34.5 500	16 232	20.7 300	
	73.0 x 60.3, 88.9 x 73.0, 114.3 x 73.0 2 1/2 x 2, 3 x 2 1/2, 4 x 2 1/2	-	34.5 500	34.5 500	34.5 500	16 232	20.7 300	
	114.3 x 60.3, 168.3 x 60.3 4 x 2, 6 x 2	-	34.5 500	34.5 500	34.5 500	16 232	- -	
	88.9 x 60.3, 114.3 x 88.9, 168.3 x 114.3 3 x 2, 4 x 3, 6 x 4	-	34.5 500	34.5 500	34.5 500	16 232	20.7 300	
	141.3 x 114.3, 168.3 x 141.3 5 x 4, 6 x 5	-	34.5 500	34.5 500	34.5 500	- -	- -	
	76.1 x 48.3, 76.1 x 60.3 76.1mm x 1 1/2, 76.1mm x 2	-	34.5 500	34.5 500	34.5 500	16 232	20.7 300	
	88.9 x 76.1, 114.3 x 76.1 3 x 76.1mm, 4 x 76.1mm	-	34.5 500	34.5 500	34.5 500	16 232	20.7 300	
	139.7 x 88.9, 139.7 x 114.3 139.7mm x 3, 139.7mm x 4	-	34.5 500	34.5 500	34.5 500	16 232	- -	
	165.1 x 114.3 165.1mm x 4	-	34.5 500	34.5 500	34.5 500	- -	20.7 300	
	168.3 x 76.1, 168.3 x 139.7 6 x 76.1mm, 6 x 139.7mm	-	34.5 500	34.5 500	34.5 500	16 232	- -	
	165.1 x 88.9, 165.1 x 139.7 165.1mm x 3, 165.1mm x 4	-	34.5 500	- -	34.5 500	- -	- -	
	 Fig. 501	42.4, 48.3, 60.3, 88.9, 114.3 1 1/4, 1 1/2, 2, 3, 4	-	20.7 300	20.7 300	20.7 300	16 232	20.7 300
		168.3, 219.1 6, 8	-	20.7 300	20.7 300	20.7 300	16 232	20.7 300
73.0, 141.3 2 1/2, 5		-	20.7 300	20.7 300	20.7 300	- -	- -	
76.1 76.1mm		-	20.7 300	20.7 300	20.7 300	16 232	20.7 300	
139.7 139.7mm		-	20.7 300	20.7 300	20.7 300	16 232	- -	
165.1 165.1mm		-	20.7 300	20.7 300	20.7 300	- -	20.7 300	
 Fig. 510		42.4, 48.3, 60.3, 88.9, 114.3 1 1/4, 1 1/2, 2, 3, 4	-	20.7 300	20.7 300	20.7 300	16 232	20.7 300
	168.3, 219.1 6, 8	-	20.7 300	20.7 300	20.7 300	16 232	20.7 300	
	73.0, 141.3 2 1/2, 5	-	20.7 300	20.7 300	20.7 300	- -	- -	
	76.1 76.1mm	-	20.7 300	20.7 300	20.7 300	16 232	20.7 300	
	139.7 139.7mm	-	20.7 300	20.7 300	20.7 300	16 232	- -	
	165.1 165.1mm	-	20.7 300	20.7 300	20.7 300	- -	20.7 300	
	 Fig. 519	42.4, 48.3, 60.3, 88.9, 114.3 1 1/4, 1 1/2, 2, 3, 4	-	20.7 300	20.7 300	20.7 300	16 232	20.7 300
168.3, 219.1 6, 8		-	20.7 300	20.7 300	20.7 300	16 232	20.7 300	
73.0, 141.3 2 1/2, 5		-	20.7 300	20.7 300	20.7 300	- -	- -	
76.1 76.1mm		-	20.7 300	20.7 300	20.7 300	16 232	20.7 300	
139.7 139.7mm		-	20.7 300	20.7 300	20.7 300	16 232	- -	
165.1 165.1mm		-	20.7 300	20.7 300	20.7 300	- -	20.7 300	

## Listing and Approval Information

(Page 8 of 8)

Tech Data Sheets: TFP1800

Figure	Nominal Size mm Inches	Pipe Schedule	Rated Pressure - Bar psi (UL, ULC, FM, LPCB, and VdS)				
			UL	ULC	FM	VdS	LPCB
 <b>Fig. 510S</b>	<b>60.3, 88.9, 114.3, 168.3, 219.1</b> 2, 3, 4, 6, 8	-	20.7 300	20.7 300	20.7 300	16 232	20.7 300
	<b>73.0, 141.3</b> 2½, 5	-	20.7 300	20.7 300	20.7 300	-	-
	<b>76.1</b> 76.1mm	-	20.7 300	20.7 300	20.7 300	16 232	20.7 300
	<b>139.7</b> 139.7mm	-	20.7 300	20.7 300	20.7 300	16 232	-
	<b>165.1</b> 165.1mm	-	20.7 300	20.7 300	20.7 300	-	20.7 300
 <b>Fig. 519S</b>	<b>60.3, 88.9, 114.3, 168.3, 219.1</b> 2, 3, 4, 6, 8	-	20.7 300	20.7 300	20.7 300	16 232	20.7 300
	<b>73.0, 141.3</b> 2½, 5	-	20.7 300	20.7 300	20.7 300	-	-
	<b>76.1</b> 76.1mm	-	20.7 300	20.7 300	20.7 300	16 232	20.7 300
	<b>139.7</b> 139.7mm	-	20.7 300	20.7 300	20.7 300	16 232	-
	<b>165.1</b> 165.1mm	-	20.7 300	20.7 300	20.7 300	-	20.7 300

\* Figure 730 Threaded Mechanical Outlets are UL and ULC Listed and FM Approved in both the Tee and Cross configuration with NPT and ISO threaded outlets as specified in the chart.

\*\* Figure 730 Grooved Mechanical Outlets are UL and ULC Listed and FM Approved in both the Tee and Cross configuration.

‡ Figure 730 Threaded and Grooved Mechanical Outlets are VdS Approved in the Tee configuration only.

**STF** Steady Flow Listed/Approved steel sprinkler pipe manufactured by AMS Tube Corp.

**BLT** Black Light Wall Threadable Listed/Approved steel sprinkler pipe manufactured by Allied Tube and Conduit.

**DF** Dyna-Flow Listed/Approved steel sprinkler pipe manufactured by Allied Tube and Conduit.

**DT** Dyna-Thread Listed/Approved steel sprinkler pipe manufactured by Allied Tube and Conduit.

**SF** Super-Flow Listed/Approved steel sprinkler pipe manufactured by Allied Tube and Conduit.

**XL** Extra Light Weight Listed/Approved steel sprinkler pipe manufactured by Allied Tube and Conduit.

**UE** Ultra-Eddy Listed/Approved steel sprinkler pipe manufactured by Bull Moose Tube Company.

**TL** TL Listed/Approved steel sprinkler pipe manufactured by Central Grooved Piping Products.

**LS** Listed/Approved steel sprinkler pipe manufactured by Century Tube Corporation.

**ID** IDOD Listed/Approved steel sprinkler pipe manufactured by IDOD Systems.

**GAL-FLO** Listed/Approved steel sprinkler pipe manufactured by IDOD Systems.

**GAL-7** Listed/Approved steel sprinkler pipe manufactured by IDOD Systems.

**EZ** EZ-Flow Listed/Approved steel sprinkler pipe manufactured by Northwest Pipe and Casting Company.

**FLF** Fire Line Flow Listed/Approved steel sprinkler pipe manufactured by Western International Forest Products.

**MF** Mega Flow Listed/Approved steel sprinkler pipe manufactured by Wheatland Tube Company.

**MLT** Mega Light Listed/Approved steel sprinkler pipe manufactured by Wheatland Tube Company.

**MT** Mega Thread Listed/Approved steel sprinkler pipe manufactured by Wheatland Tube Company.

**SL** Listed/Approved steel sprinkler pipe manufactured by Wheatland Tube Company.

**WLS** WLS Listed/Approved steel sprinkler pipe manufactured by Wheatland Tube Company.

**WST** WST Listed/Approved steel sprinkler pipe manufactured by Wheatland Tube Company.

**GL** GL Listed/Approved steel sprinkler pipe manufactured by Wheatland Tube Company.

**EZT** EZ Thread Listed/Approved steel sprinkler pipe manufactured by Youngstown Tube Company.

**FF** Fire-Flo Listed/Approved steel sprinkler pipe manufactured by Youngstown Tube Company.

**5** Schedule 5 steel sprinkler pipe

**10** Schedule 10 steel sprinkler pipe

**20** Schedule 20 steel sprinkler pipe

**30** Schedule 30 steel sprinkler pipe

**40** Schedule 40 steel sprinkler pipe

**BS1387m** British Standard Medium Listed/Approved steel sprinkler tube.

**ISO4200** ISO Standard Listed/Approved steel sprinkler tube.

**Note:** Cut and roll grooved references are for pipe runs and also grooved outlets.



# INDICES

## Keyword Index

11- $\frac{1}{4}$ ° Elbows . . . . .	32	Flange Adaptor Washers . . . . .	26
22- $\frac{1}{2}$ ° Elbows . . . . .	32	Flange Adaptors. . . . .	22 - 25, 47 - 48
45° Cast Elbows . . . . .	31	Flange Drilling Specifications. . . . .	96
90° Cast Elbows . . . . .	30	Flexible Couplings . . . . .	16
90° Drain Elbows with 25mm Outlet . . . . .	31	Flexible Joints . . . . .	92
ADACAP, NPT Threads. . . . .	45	Flexible Reducing Couplings . . . . .	18
Adaptor Nipples. . . . .	40	Gasket Lubricants . . . . .	78
Adaptors, Flange . . . . .	47 - 48	Gasket Grades & Recommendations . . . . .	78
Agency Listings and Approvals . . . . .	8	Gasket Styles. . . . .	77
Approvals . . . . .	99 - 106	Gasket Types . . . . .	76
Automated Roll Groovers . . . . .	83	Gaskets . . . . .	76 - 78
Bullhead Tees . . . . .	35	Gate Valves Outside Screw & Yoke (OS&Y), Resilient-Seated . . . . .	67 - 69
Butterfly Valves – Groove x Groove, Model BFV-N . . . . .	64	Gate Valves, Outside Screw & Yoke, Flange x Flange . . . . .	68
Butterfly Valves – Lug Style, Model BFV-N . . . . .	66	Gate Valves, Outside Screw & Yoke, Flange x Groove. . . . .	69
Butterfly Valves – Wafer Style, Model BFV-N . . . . .	65	Gate Valves, Outside Screw & Yoke, Groove x Groove . . . . .	69
Butterfly Valves, Model BFV-N . . . . .	64 - 66	Gate Valves, Non Rising Stem Resilient-Seated . . . . .	70 - 74
Caps, End . . . . .	46	Gate Valves, NRS. . . . .	71 - 72
Check Valves, Model CV-1F G-FIRE Grooved . . . . .	61	Global Pipe Size Designations . . . . .	98
Check Valves, Riser, Model CV-1FR G-FIRE Grooved Shotgun . . . . .	62 - 63	GRINNELL Gasket Grade & Recommendations . . . . .	78
Concentric Reducers . . . . .	42 - 43	GRINNELL Gasket Lubricants . . . . .	78
Conversion Chart, Metric/Imperial . . . . .	94	GRINNELL Gasket Types . . . . .	76
Coupling Installation Information . . . . .	14	GRINNELL Website Overview . . . . .	10
Cross Wall Indicator Post . . . . .	74	Groove Specification, Cut . . . . .	82
Crosses . . . . .	44	Groove Specification, Roll . . . . .	81
Crosses, & Tees, Mechanical – Threaded. . . . .	52 - 54	Groove x Groove x Male Thread Reducing Tees . . . . .	39
Crosses, & Tees, Mechanical – Grooved . . . . .	55 - 57	Groove x Groove x Male Thread Tees. . . . .	34
Crosses, Mechanical . . . . .	50 - 57	Grooved Check Valves, Model CV-1F. . . . .	61
Cut Groove Standard Specification for Steel & Other IPS Pipe. . . . .	82	Grooved Coupling Specifications . . . . .	13
Cut Groovers, Portable . . . . .	84	Grooved Couplings . . . . .	11 - 26
Deflection & Misalignment . . . . .	91	Grooved Fittings . . . . .	27 - 57
Design Data. . . . .	90 - 106	Groovers, Portable Cut . . . . .	84
Drain Elbows, 90° . . . . .	31	Groovers, Roll, Automated . . . . .	83
Drilling Specifications . . . . .	26	Groovers, Roll, Field Portable . . . . .	83
Elbows, 11- $\frac{1}{4}$ °. . . . .	32	Heavy Duty Flexible Couplings. . . . .	17
Elbows, 22- $\frac{1}{2}$ °. . . . .	32	High Pressure Rigid Couplings . . . . .	19
Elbows, 45° Cast . . . . .	31	Hole Cutting Tool. . . . .	84, 88
Elbows, 90° Cast . . . . .	30	ISO 9001:2008 Certified . . . . .	9
End Caps . . . . .	46	Joints, Flexible. . . . .	92
Field Portable Roll Groovers . . . . .	83	Joints, Rigid . . . . .	92
Fittings . . . . .	27 - 57	Linear Movements. . . . .	93
Fittings Specifications . . . . .	29		

**Keyword Index**

Listing and Approvals . . . . .	99 - 106
Lubricants, Gasket . . . . .	78
Material Specifications . . . . .	50
Mechanical Crosses . . . . .	50 - 57
Mechanical Outlet Couplings . . . . .	20 - 21
Mechanical Tees . . . . .	50 - 57
Mechanical Tees & Crosses – Grooved . . . . .	55 - 57
Mechanical Tees & Crosses – Threaded . . . . .	52 - 54
Metric/Imperial Conversion Chart . . . . .	96
Misalignment & Deflection . . . . .	91
Model number index . . . . .	97
Nipples, Adaptor . . . . .	40
Non Rising Stem Resilient-Seated Gate Valves . . . . .	70 - 74
Outlet Couplings . . . . .	20 - 21
Outlet, Sprinkler, Threaded . . . . .	51
Outside Screw & Yoke (OS&Y), Gate Valves, Resilient-Seated . . . . .	67 - 69
Pictorial Table of Contents, Grooved Couplings . . . . .	12
Pictorial Table of Contents, Grooved Fittings . . . . .	28
Pictorial Table of Contents, Mechanical Tees . . . . .	50
Pictorial Table of Contents, Preparation Equipment . . . . .	80
Pictorial Table of Contents, Valves . . . . .	60
Pipe Conversion Table . . . . .	97
Pipe Size Designations . . . . .	98
Pipe Support . . . . .	92 - 94
Pipe Support Stands . . . . .	84
Pipe Tape . . . . .	84
Piping, Vertical . . . . .	93
Portable Cut Groovers . . . . .	84
Portable Roll Grooving Machine . . . . .	83, 87
Post, Vertical Indicator . . . . .	73
Post, Wall Indicator . . . . .	74
Preparation Equipment . . . . .	79 - 88
Pressure and Design Data . . . . .	91 - 94
Reducers, Concentric . . . . .	42 - 43
Reducers, Small End Threaded (Male) . . . . .	41
Reducing Tees . . . . .	36 - 38
Reducing Tees, Groove x Groove x Male Thread . . . . .	39
Resilient-Seated Gate Valves Outside Screw & Yoke (OS&Y) . . . . .	67 - 69
Rigid Couplings . . . . .	15
Rigid Joints . . . . .	92
Riser Check Valves, Shotgun, Model CV-1FR G-FIRE Grooved . . . . .	62 - 63

Roll Groove Standard Specification for Steel & Other IPS Pipe . . . . .	81
Roll Groovers, Automated . . . . .	83
Roll Groovers, Field Portable . . . . .	83
Rotational Movements . . . . .	93
Short Pattern 90° Cast Elbows . . . . .	30
Short Pattern Tees . . . . .	33
Shotgun Riser Check Valves, Model CV-1FR G-FIRE Grooved . . . . .	62 - 63
Size Designations, Global Pipe . . . . .	94
Sprinkler Outlet, G-FIRE, Threaded . . . . .	51
Standpipe Tees . . . . .	35
Stands, Pipe Support . . . . .	84
Supports, Pipe . . . . .	91 - 92
Tape, Pipe . . . . .	84
Tees . . . . .	33
Tees & Crosses, Mechanical – Grooved . . . . .	55 - 57
Tees & Crosses, Mechanical – Threaded . . . . .	52 - 54
Tees, Bullhead . . . . .	35
Tees, Groove x Groove x Male Thread . . . . .	34
Tees, Mechanical . . . . .	50 - 57
Tees, Reducing . . . . .	36 - 39
Tees, Short Pattern . . . . .	33
Tees, Standpipe . . . . .	35
Threaded Reducers, Small End (Male) . . . . .	41
Tool, Hole Cutting . . . . .	84, 88
Valves . . . . .	59 - 74
Valves, Butterfly – Lug Style, Model BFV-N G-FIRE . . . . .	66
Valves, Butterfly – Wafer Style, Model BFV-N G-FIRE . . . . .	65
Valves, Butterfly, Groove x Groove, Model BFV-N G-FIRE . . . . .	64
Valves, Check, Model CV-1F G-FIRE Grooved . . . . .	61
Valves, Check, Riser, Model CV-1FR G-FIRE Grooved Shotgun . . . . .	62 - 63
Valves, Gate, Outside Screw & Yoke (OS&Y), Resilient-Seated . . . . .	67 - 69
Valves, Gate, Non Rising Stem Resilient-Seated . . . . .	70 - 74
Vertical Indicator Post . . . . .	73
Vertical Piping . . . . .	93
Wall Thickness . . . . .	97
Washers, Flange Adaptor . . . . .	26
Why GRINNELL? . . . . .	7
Why Grooved? . . . . .	6

## Model Number Index

Agency Listings and Approvals . . . . .	8
Approvals and Listings. . . . .	99 - 106
Automated Roll Groovers . . . . .	83
Automatic Roll Grooving Machine . . . . .	86
Design Data . . . . .	90
Field Portable Roll Groovers. . . . .	83
Figures 50L/507 Bullhead Tees. . . . .	35
Figure 71 Flange Adapters (AS2129 Table E) . . . . .	25
Figure 71 Flange Adaptors (ANSI Class 125/150) . . . . .	24
Figure 71 Flange Adaptors (PN10/PN16) . . . . .	22
Figure 71 Flange Adaptors (PN10/PN16) . . . . .	23
Figures 211 & 311, 11- $\frac{1}{4}$ ° Elbows. . . . .	32
Figures 212 & 312, 22- $\frac{1}{2}$ ° Elbows. . . . .	32
Figures 221 & 321 Reducing Tees . . . . .	36
Figures 221 & 321 Reducing Tees . . . . .	37
Figures 221 & 321 Reducing Tees . . . . .	38
Figures 227 & 327 Crosses . . . . .	44
Figures 250 & 350 Concentric Reducers . . . . .	42 - 43
Figures 260 & 360 End Caps . . . . .	46
Figures 311 & 211, 11- $\frac{1}{4}$ ° Elbows. . . . .	32
Figures 312 & 212, 22- $\frac{1}{2}$ ° Elbows. . . . .	32
Figure 320 Groove x Groove x Male Thread Tees . . . . .	34
Figure 323 Groove x Groove x Male Thread Reducing Tees . . . . .	39
Figures 327 & 227 Crosses . . . . .	44
Figure 341 Flange Adaptors (ANSI Class 150#) . . . . .	48
Figure 343 Flange Adaptors (JIS) . . . . .	47
Figure 343 Flange Adaptors (PN10) . . . . .	47
Figure 343 Flange Adaptors (PN16) . . . . .	47
Figure 343 Flange Adaptors (Table E) . . . . .	48
Figures 360 & 260 End Caps . . . . .	46
Figure 372 Reducers, Small End Threaded (Male) . . . . .	41
Figures 391, 392 & 393 Adaptor Nipples . . . . .	40
Figure 501 45° Cast Elbows . . . . .	31
Figures 507/50L Bullhead Tees. . . . .	35
Figure 508 Standpipe Tees . . . . .	35
Figure 510 90° Cast Elbows . . . . .	30
Figure 510DE 90° Drain Elbows with 25mm Outlet . . . . .	31
Figure 510S Short Pattern 90° Cast Elbows . . . . .	30
Figures 519 Tees . . . . .	33
Figure 519S Short Pattern Tees . . . . .	33
Figure 522 G-FIRE Sprinkler Outlet, Threaded . . . . .	51
Figure 577 G-FIRE Rigid Couplings . . . . .	15
Figure 702 Outlet Couplings . . . . .	20
Figure 702 Outlet Couplings . . . . .	21
Figure 705 Flexible Couplings. . . . .	16
Figure 707 Heavy Duty Flexible Couplings . . . . .	17
Figure 716 Flexible Reducing Couplings . . . . .	18
Figure 730 Mechanical Tees & Crosses – Grooved . . . . .	55 - 57
Figure 730 Mechanical Tees & Crosses – Threaded . . . . .	52 - 54
Figure 750 ADACAP . . . . .	45
Figure 770 High Pressure Rigid Couplings . . . . .	19

## Model Number Index

Fittings Specifications . . . . .	29
Flange Adaptor Washers . . . . .	26
Flange Drilling Specifications . . . . .	96
Flexible Joints . . . . .	92
Gasket Styles . . . . .	77
Global Pipe Size Designations . . . . .	98
GRINNELL Gasket Grade & Recommendations . . . . .	78
GRINNELL Gasket Lubricants . . . . .	78
GRINNELL Gasket Types . . . . .	76
GRINNELL Website . . . . .	10
Grooved Coupling Specifications . . . . .	13
Grooved Couplings . . . . .	12
Grooved Fittings Pictorial Table of Contents . . . . .	28
Grooving Equipment . . . . .	83
Hole Cutting Tool . . . . .	84, 88
Listings and Approvals . . . . .	99 - 106
Mechanical Tees Pictorial Table of Contents . . . . .	50
Misalignment & Deflection . . . . .	91
Model BFV-N Butterfly Valves – Groove x Groove . . . . .	64
Model BFV-N Butterfly Valves – Lug Style . . . . .	66
Model BFV-N Butterfly Valves – Wafer Style . . . . .	65
Model CV-1F Grooved Check Valves . . . . .	61
Model CV-1FR Grooved Shotgun Riser Check Valves . . . . .	62 - 63
Model CV-1FR Grooved Shotgun Riser Check Valves . . . . .	63
Model POST-IND Vertical Indicator Post . . . . .	73
Model TMCG-P Gate Valves, NRS, Groove x Groove . . . . .	72
Model TMCT-P Gate Valves, NRS, Flange x Groove . . . . .	72
Model TMCX-P Gate Valves, NRS, Flange x Flange . . . . .	71
Model TMCX-P Non Rising Stem Gate Valves . . . . .	70
Model TMR Gate Valves Outside Screw & Yoke (OS&Y) . . . . .	67
Model TMRG Gate Valves (OS&Y), Groove x Groove . . . . .	69
Model TMRT Gate Valves (OS&Y), Flange x Groove . . . . .	69
Model TMRX Gate Valves (OS&Y), Flange x Flange . . . . .	68
Model TWG-IV A . . . . .	
Model TWG-IV Z . . . . .	
Model TWG-VI A . . . . .	87
Model TWK-III A . . . . .	88
Model WALL-IND Cross Wall Indicator Post . . . . .	74
Pipe Conversion Table Wall Thickness . . . . .	97
Pipe Support . . . . .	92 - 94
Pipe Support Stands . . . . .	84
Pipe Tape . . . . .	84
Portable Cut Groovers . . . . .	84
Portable Roll Groovers . . . . .	83
Portable Roll Grooving Machine . . . . .	87
Preparation Equipment Pictorial Table of Contents . . . . .	80
Rigid Joints . . . . .	92
Roll Groove Standard Specification for Steel & Other IPS Pipe . . . . .	81
Roll Grooving Machine . . . . .	85
Valves Pictorial Table of Contents . . . . .	60
Vertical Piping . . . . .	95

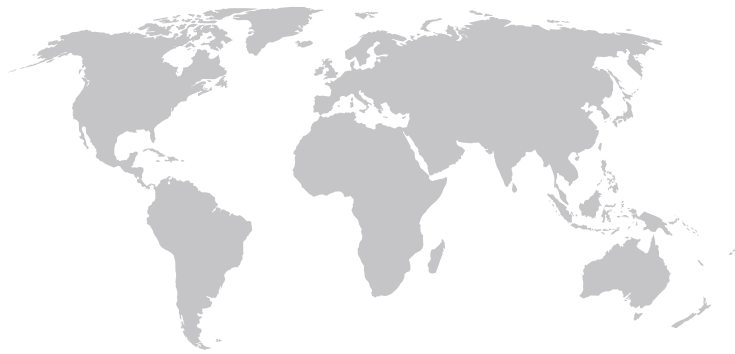

# Global Strength. Local Expertise. At your service.

---

## APAC Regional Offices

### Australia

Level 3, 95 Coventry Street  
Southbank, VIC 3006, Australia

**Phone:** +1300 725 688  
(within Australia)

**Fax:** +1300 720 733  
(within Australia)

**Phone:** +61 3 9313 9700

**Fax:** +61 3 9313 9709

**E-mail:** [info.aust@tycofp.com](mailto:info.aust@tycofp.com)

### India

1001, Wing 'C', 10th Floor,  
Godrej Coliseum, Sion  
Mumbai - 400 022, India

**Phone:** +91 22 6628 6628

**Fax:** +91 22 6628 6650

**E-mail:** [info.india@tycofp.com](mailto:info.india@tycofp.com)

### Shanghai

2F, Building No.1,  
Lane 955

Jinhai Road, Pudong  
Shanghai 201206

**Phone:** +86 21 6163 3373

**Fax:** +86 21 6163 3371

**E-mail:** [info.china@tycofp.com](mailto:info.china@tycofp.com)

### Hong Kong

Units 905-923, 9/F,  
Trade Square,  
681 Cheung Sha Wan Road,  
Cheung Sha Wan,  
Kowloon, Hong Kong

**Phone:** +852 2753 3524

**Fax:** +852 2505 5826

**E-mail:** [info.china@tycofp.com](mailto:info.china@tycofp.com)

### Singapore

2 Serangoon North Avenue 5  
#07-01, Singapore 554911

**Phone:** +65 6577 4360

**Fax:** +65 6481 8791

**E-mail:** [info.apac@tycofp.com](mailto:info.apac@tycofp.com)

GF-GFIREEU-201303\_EN

© 2013 Tyco Fire Products LP. All rights reserved.

GRINNELL is a mark and/or registered trademark of Tyco International Ltd.



[www.grinnell.com](http://www.grinnell.com)

**tyco**  
Fire Protection Products