

Digital Indicator
CSD-815B

Instruction Manual

Minebea Co., Ltd.
Measuring Components Business Unit

Forwards

Thank you very much for your purchasing Minebea's Digital Indicator CSD-815B.

This manual explains installation procedures and connecting method and also operating method for the Digital Indicator. Make use of it properly after reading through the manual carefully.

Be sure to deliver the manual to the end user. Moreover, the end user should keep the manual at hand after reading it over.

This manual is intended for the technical experts to read.

●The contents of the manual may subject to change for improvement without notice.

Marks and arrangements used in this manual

The following marks are attached to the explanation on the matters that indicate “Don’t do this.”, “Take care.” and “For reference”.

Be sure to read these items where these marks are attached.



Warning

- Warning may cause injury or accident that may harm to the operator.
Don’t do these things described here.



- Caution during operation and working.

Be sure to read the item to prevent malfunction.

Mark during operation.



- Press the switch.

For safe operation

Be sure to read this instruction manual before use.

1. Installation place



- Use the instrument where the temperature/humidity specifies with the range as follows :

Environmental temperature : $-10\text{ }^{\circ}\text{C}$ to $50\text{ }^{\circ}\text{C}$

Environmental humidity : Less than 85 %R.H. (Non condensing)

(1) Location where installation is not allowed.



- Warning ● Do not locate the instrument on the places as follows :
It may cause an unexpected faulty in the instrument.

- Do not locate the instrument in direct and/or high temperature area.
- Do not use the instrument in a high humid area.
- Do not install the instrument where there are vibrations and shocks.
- Do not use the instrument where there is excess of dusts and fine particles.
- Do not use the instrument where there are corrosive gas and salt and like that.
- Do not install the instrument where there is rapid change of temperature and humidity.
- Do not install the instrument near the devices that are magnetized or generate an electromagnetic field.
- Do not install the instrument where the instrument may be affected by radioactivity or radial rays.
- Avoid the location where chemical reaction may take place such as in a laboratory, or like that.

(2) Installation



- When installing the instrument, install as referring to the following figures and secure the space around the instrument.

Each dimensions of the instrument and required dimensions for the environmental spaces are as follows:

Outline dimensions

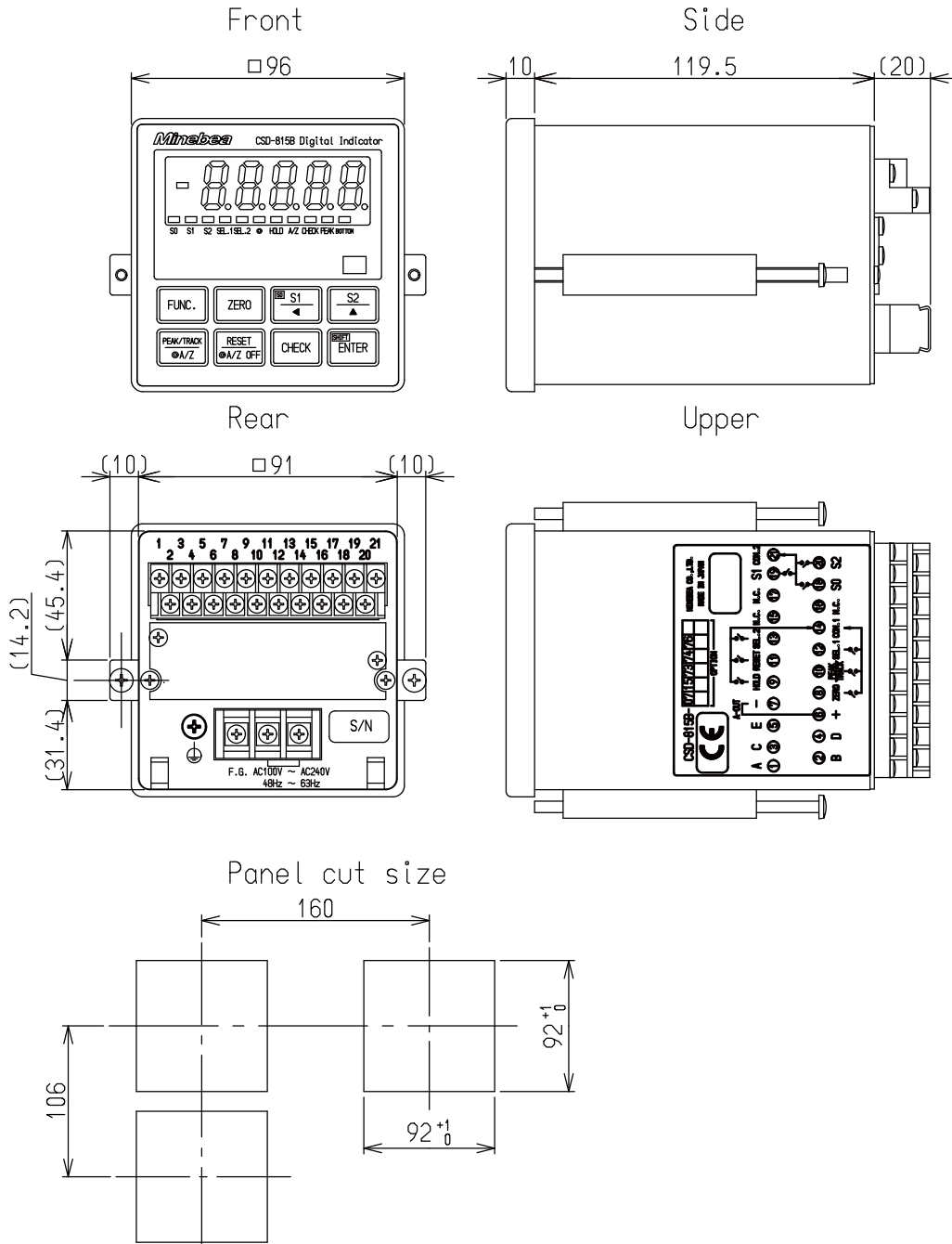

2. Power supply



Warning

- Be sure to check that the power supply is off in connecting each cable. If the work is done while the power is on, there may have the case that electric shock to the operator or even may have damage to the instrument.



- Before supplying the power, check that the indication of power supply voltage/specifications for the instrument and the power going to supply should be the same. If they are not equal, contact with Minebea. If you use the instrument without checking them, it may cause a damage in the instrument or electric shock to the operator.



- Earth wire should be grounded securely. When earth wire is not connected, it may cause a malfunction of the instrument or electric shock to the operator.

3. Application note



Warning

- Before using a new instrument or exchanging the strain gage applied transducer for a new one, be sure to make calibration. If calibration will not be made, the correct measuring results may not be obtained nor which may cause malfunction in the instrument and there may exist damage in peripheral equipments. Besides, even though calibration has been made, there may occur the similar case when the results are not correct, so make calibration, again.





Warning

- In case of using the instrument, check that the connections are executed properly. If not connected properly, the correct measuring result will not be obtained, nor it may cause malfunctions of the instrument, damage to the peripheral equipments or even more serious accidents.

 Warning ● When change of setting is made carelessly on the instrument during measurement, correct measured results may not be obtained and it may cause malfunction in the instrument and even have the possibility of damage in peripheral instruments.

 Warning ● Do not shock the instrument such as throwing something on it. If neglected, it may cause destruction of the parts and damage to the electrical circuits.

 Warning ● Do not push the panel sheet on the instrument with the excessive strong force nor push it with sharp edge object such as a driver. If neglected, it may cause a damage to the panel switch and even have the possibility of damage to resist to environments or operational performances.

 Warning ● Do not remove the cover of the case of the instrument, nor peel off the panel sheet nor take the instrument into pieces. If neglected, it may cause a damage to the case and the panel sheet and even have the possibility of damage to resist to environments or operational performances.

 ● At the time of shipment from the factory, the instrument has been plated with a clear sheet on the panel sheet for protective purpose. In case of application, use the instrument after removing the clearsheet first.

4. CE conformity standard

This instrument has suited the following standard.

EN61326 : 2006

“Electrical equipment for measurement, control, and laboratory use – EMC requirements”
“Immunity test requirements for equipment intended for use in industrial locations”

EN61010–1 : 2001

“Safety requirements for electrical equipment for measurement, control and laboratory use
– Part 1 : General requirement”



Warning

- Please observe the following conditions strictly when this instrument suits the above–mentioned standard.
If neglected, there is a possibility of not suiting the above–mentioned standard.



- CE conformity standard is not effective in case of using optional CC–LINK interface.

(1). Wiring

① Shield processing

- Cables other than power cable must use all shielded cables.
- Refer to relative notes, about method of shield processing.

② Grounding









- The ground of this instrument shall apply the individual ground by using the protective ground terminal

History of revision

Date	Instruction Manual No.	Details of revised point
Sep. 2009	DRW.NO. EN294-1434	First Version ROM Ver. 1.100 or later
Jan. 2010	DRW.NO. EN294-1434A	Due.ECN.No.FN10-02016 ROM Ver.1.200 or later • 8-2. 13-3. F-84 has added. • 11-11-3. 4 occupied stations ⇒ Changed to the occupied of 1,2 and 4 occupied stations.
Feb. 2010	DRW.NO. EN294-1434B	Due.ECN.No.FN10-02016A - Addition - 8-2. F-84 "Restriction and warning" is added.
May 2010	DRW.NO. EN294-1434C	Due.ECN.No.FN10-01019A - Addition - 3-4. [Applicable environment] is added. 11-10. Accessories Panel mounting gasket is added.
Oct. 2010	DRW.NO. EN294-1434D	Due.ECN.No.FN10-02140 - Addition - Minebea logo is changed.
Jan.2011	DRW.NO. EN294-1434E	Due to ECN NO.FN11-02018 - Correction - 9-3-4. "DE-9S-N (JAE)" to "DE-9S-NR by JAE or equivalent."
May 2012	DRW.NO. EN294-1434F	Due.ECN.No.FN10-02140-D - Addition - Minebea logo is changed.
Aug 2012	DRW.NO. EN294-1434G	Due to ECN NO.FN12-02114 ROM Ver.1.300 or later - Correction - • 7-9 "10 ⁴ digit : Optional output" to "10 ⁴ digit : Optional output(BCD output, CC-Link load output, RS-232C load output, RS-422/485 load output)" - Addition - • 7-9 Caution is added.

INDEX

Forwards	I
Marks and arrangements used in this manual	II
For safe operation	III
1. Installation place	III
2. Power supply	V
3. Application note	V
4. CE conformity standard	VII
History of revision	VIII
1. General	1
1-1. Features	1
2. Name and function of each point	2
2-1. Front panel	2
2-2. Rear panel	4
3. Installation procedures	5
3-1. Installation place	5
3-2. Location where installation is not allowed.	5
3-3. Installation	6
3-4. Applicable environment	7
4. Connecting method	8
4-1. Layout of the terminal boards	8
4-2. Note on connection	9
4-3. Connection	10
4-3-1. Connection with strain gage applied transducers	10
4-3-2. Connection with external control inputs	14
4-3-3. Connection with contact outputs	15
4-3-4. Connection with the power supply and the earth	17
4-3-5. Connection with analog outputs	18
5. Calibration procedures	20
5-1. Preparations	20
5-2. Calibration procedures	20
5-2-1. Calibration method to register the output of strain gage applied transducer at the time of maximum display after setting the load to zero	22
5-2-2. Calibration procedures to register the output of strain gage applied transducer at the time of zero and the maximum display	27
5-2-3. Calibration method to register by reading output value of strain gage applied transducer in the conditions of zero/actual load application individually	32
5-2-4. Zero fine adjustment	38
5-2-5. Span fine adjustment	41
5-2-6. Calibration procedure to apply registration again for zero point only .	44
5-3. Selection of calibration methods on each condition	47
5-3-1. In case of executing the calibration on the instrument newly.	47
5-3-2. When the calibration is executed again.	51
5-4. Setting the prohibition against calibration	51
5-5. Changeover of calibration data	52
6. Operation procedure	53

6-1.	 key	53
6-1-1.	Operations in Measurement mode	53
6-2.	 key	53
6-2-1.	Operated in the Measurement mode	53
6-2-2.	Operation is made in another mode	53
6-3.	 key	54
6-3-1.	Operated in the Measurement mode	54
6-3-2.	Operation is made in another mode	54
6-4.	 key	55
6-4-1.	When operated in the Measurement mode.	55
6-4-2.	When operated in another modes	55
6-5.	 key	55
6-5-1.	When operated in the Measurement mode.	55
6-6.	 key	56
6-6-1.	When operated in the Measurement mode	56
6-6-2.	When operated in another modes.	56
6-7.	 key	56
6-7-1.	When operated in the Measurement mode.	56
6-8.	 key	56
7.	Function and operation	57
7-1.	External control input signal and contact output signal	57
7-1-1.	Input signal for external control	57
7-1-2.	Contact output signal	59
7-1-3.	Equivalent circuit	59
7-2.	Comparator	60
7-2-1.	ON/OFF for the Comparator S0, S1 and S2.	60
7-2-2.	Changeover of comparator code	60
7-2-3.	Change of set value	61
7-2-4.	Operation on comparator S1, S2	63
7-2-5.	Comparative target for comparator S1, S2	64
7-2-6.	Operation of comparator S0	65
7-2-7.	Hysteresis on comparator	68
7-3.	How to use the filter	70
7-3-1.	Analog filter	70
7-3-2.	Digital filter	70
7-4.	Zero tracking	71
7-4-1.	What is zero tracking?	71
7-4-2.	Setting related with zero tracking.	71
7-4-3.	Cancellation for compensation by zero tracking	72
7-5.	Stabilized filter	73
7-5-1.	What is the Stabilized filter?	73
7-5-2.	Setting related with the Stabilized filter.	73
7-6.	Change of Peak function and A/Z function	74
7-7.	How to use various kinds of peak holds.	75
7-7-1.	Selection of the Analog peak hold and the Digital peak hold	75
7-7-2.	Peak hold	75

7-7-3. Bottom hold	76
7-7-4. Peak bottom hold	76
7-8. Various kinds of functions related with the display	77
7-8-1. Selection of target of display	77
7-8-2. Selection of position of decimal point display	77
7-8-3. Load display range	77
7-9. Selection the target for HOLD	77
7-10. Change of bridge power supply voltage	78
7-11. Tare weight cancellation (A/Z)	79
7-12. Zero set	79
7-13. Key lock	80
7-14. CHECK value	80
7-15. How to use the analog output	81
7-15-1. Scaling of analog output	82
7-15-2. Fine adjustment 1 on analog output	83
7-15-3. Fine adjustment 2 on analog output	86
7-15-4. Selection of the target of analog output	88
7-16. Memory location for setting data and so on	89
7-17. Prohibition of calibration	89
7-18. Check mode	90
7-18-1. Operating procedure for the check mode	90
7-19. Monitor mode	96
8. Function mode	98
8-1. Setting method for function mode	98
8-2. Function of Function data	101
9. Options	110
9-1. Current output	110
9-1-1. Related functions	110
9-1-2. Specifications for the current output	110
9-2. BCD output	111
9-2-1. Related function	111
9-2-2. Specifications for BCD output	111
9-2-3. Pin configurations for the BCD output connector	112
9-2-4. Equivalent circuit for input/output	113
9-2-5. Timing chart	113
9-2-6. Output condition	115
9-2-7. Selection of output logic for P.C.(Print command), and selection of its width	117
9-3. RS-232C interface	117
9-3-1. Related function	117
9-3-2. Specifications for interface	118
9-3-3. Procedures of data transfer	119
9-3-4. Pin configurations for connector pin	120
9-3-5. Data format	122
9-3-6. Communication error process	126
9-4. RS-422/485 interface	127
9-4-1. Related functions	127
9-4-2. Specifications on interface	128
9-4-3. Procedure of data transmission	128
9-4-4. Pin layout and wiring of Connector	129

9-4-5. Data format	132
9-4-6. Process of communication error	135
10. Trouble shooting	136
10-1. Execute trouble shooting	137
10-2. Optional check	146
10-3. Error display	152
11. Specifications	153
11-1. Specifications for analog section	153
11-2. Specifications for digital section	153
11-3. Front panel sheet key function	154
11-4. External control function	154
11-5. Comparator function	155
11-6. Contact output signal	155
11-7. Various kinds of functions	155
11-8. General specifications	156
11-9. Standard specifications at the shipment	156
11-10. Accessories	156
11-11. Options	156
11-11-1. Current output	156
11-11-2. BCD output	157
11-11-3. CC-LINK interface	157
11-11-4. RS-232C interface	158
11-11-5. RS-422/485 interface	158
11-12. Outline dimensions	159
12. Warranty	160
12-1. Warranty	160
12-2. Repair	160
13. Appendix	161
13-1. Replacement of fuse	161
13-2. Character's pattern for display	163
13-3. Setting table for functions	164

1. General

The instrument is a digital indicator for the application of strain gage applied transducer.

1-1. Features

Main features for CSD-815B are as follows :

(1) Compact size and light weight

96 mm × 96 mm × 130 mm Approx. 500 g (Without any options)

(2) Can be used with the selection of A/Z function and Peak hold function.

(3) 4 kinds of peak hold modes can be selectable.

Can be used by selecting from the four(4) modes of Analog peak hold, Digital peak hold, Digital bottom hold and Digital peak bottom hold.

(4) 4 kinds of "Calibration data" and "Comparator code" are memorized, and can be used by changeover of them.

(5) Non-linearity

Display 0.01 %FS.

2. Name and function of each point

2-1. Front panel

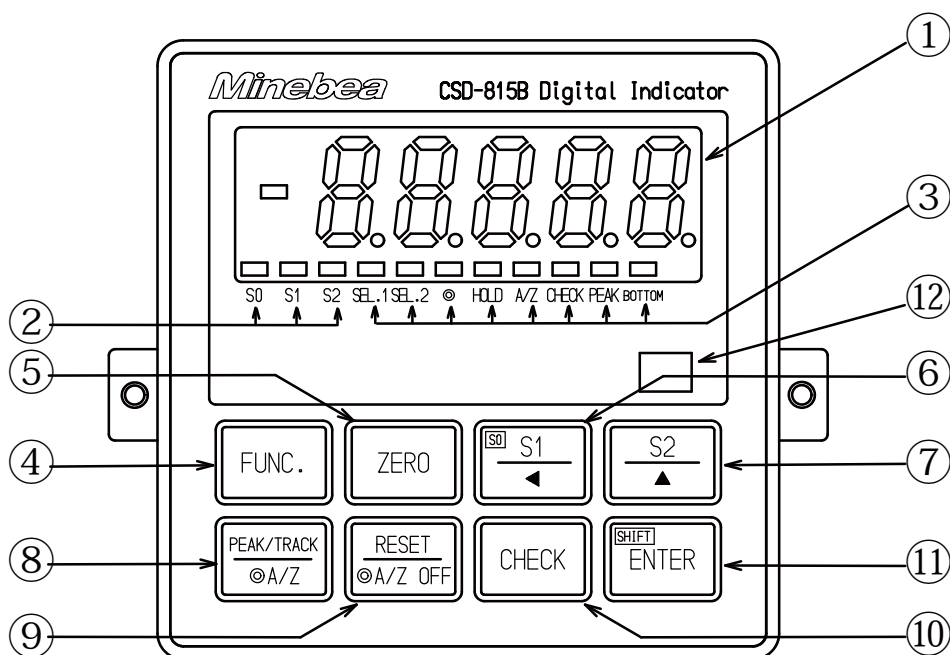

① Load display section

The load data is shown in the Measurement mode, and status or set value is shown in various kinds of Calibration mode and Setting mode.

② Judgement display

Compared results by comparator function can be displayed.

③ Status display

SEL.1、 SEL.2 They light on when the short-circuit is made between SEL.1, SEL.2 and COM.1 of external control input.

◎ It lights on when selecting A/Z or A/Z OFF function in the Function mode.
In the same way, light off when selecting Peak hold function in the Function mode.

HOLD It lights on when between the HOLD and COM. at the external control input is shorted.

A/Z It lights on at the time of executing Tare weight cancellation(A/Z ON).
It lights off with the tare weight cancellation clear.
(Effective when selecting the A/Z or A/Z OFF function in the function mode.)

CHECK It lights on when the CHECK is ON by pressing the "CHECK".

PEAK It lights on when selecting the Peak mode or Peak bottom mode.

BOTTOM It lights on when selecting the Bottom mode or Peak bottom mode.

④ key

Used when shifting to the Function mode.

⑤ key

Executes zero set. (One-touched zero adjustment)

⑥  key

Used when calling the S1 set value changeover mode, or carrying digit at the time of various kinds of settings.

Also, by pressing this key and the  key together, it is used when calling S0 set value changeover mode.

⑦  key

Used when calling the S2 set value changeover mode, or for the increment of values at the time of various kinds of settings.

⑧  key

Used for making the changeover mode of Peak/Track, or executing the Tare weight cancellation (A/Z ON).

(Changeover of Peak hold function and A/Z function depends on the setting of Function mode.)

⑨  key

Used for the reset of Peak/Bottom value, or for Tare weight cancellation clear(A/Z OFF).

(Changeover of Peak hold function and A/Z function depends on the setting of Function mode.)

⑩  key

Used when ON/OFF of CHECK value is required.

⑪  key

Used for registering set values at the time of various kinds of settings.

Also, used for calling the S0 set value changeover mode by pressing  key and  key together.

⑫ Position of pasting the Unit seal

As necessity requires, paste the Unit seal attached.

2-2.Rear panel

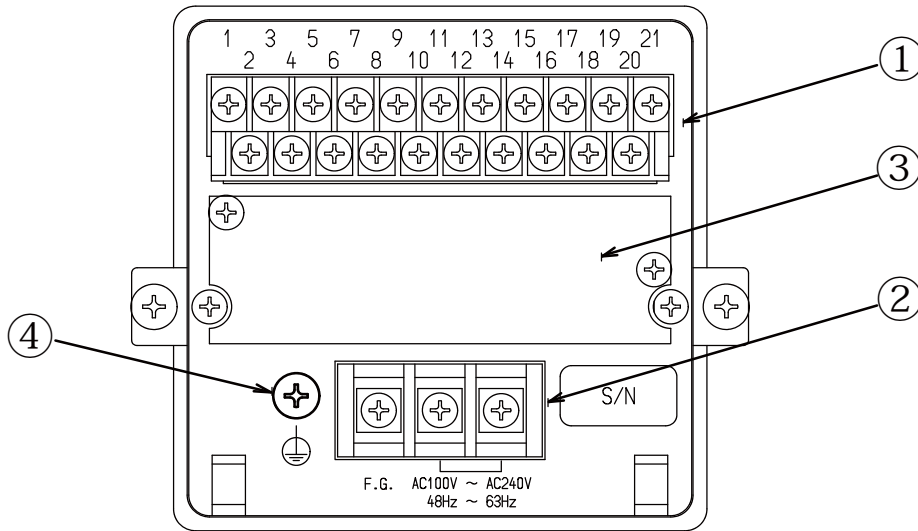

① Terminal block 1

Connects with external control input, contact output, various kinds of strain gage applied transducer such as load cell and analog output.

② Terminal block 2

Connects with AC power supply and a grounding wire.

③ Installing section for options

Whichever one can be installed from the optional BCD-OUT, CC-Link, RS-232C and RS-422/485. When there is no option, the cover is attached instead

④ Protective earth terminal

Connect the grounding wire when the instrument suits to CE conformity standard.
Do not connect except the grounding wire.

3. Installation procedures

3-1. Installation place



- Use the instrument where the temperature/humidity specifies within the range as follows:

Environmental temperature : $-10\text{ }^{\circ}\text{C}$ to $50\text{ }^{\circ}\text{C}$

Environmental humidity : 85 %RH or less(Non condensing.)

3-2. Location where installation is not allowed.



- Warning** ● Do not locate the instrument on the places such as follows:
It may cause an unexpected faulty in the instrument.

- Do not expose the instrument in direct sunlight and/or high temperature area.
- Do not use the instrument in a high humid area.
- Do not install the instrument where there is high mechanical vibrations and shock.
- Do not use the instrument where there are excess of dusts and fine particles.
- Do not install the instrument where there include any corrosive gas or any salty atmosphere.
- Do not install the instrument where there is rapid change of temperature and humidity.
- Do not install the instrument near the devices that are magnetized or generate an electromagnetic field.
- Do not install the instrument where there may suffer radioactivity or radioactive rays.
- Avoid the location where chemical reaction may take place such as in a laboratory, or like that.

3-3.Installation



● When installing the instrument, install as the following figures and secure the space around the instrument.

Each dimensions of the instrument and required dimensions for the environmental spaces are as follows:

Outline dimensions

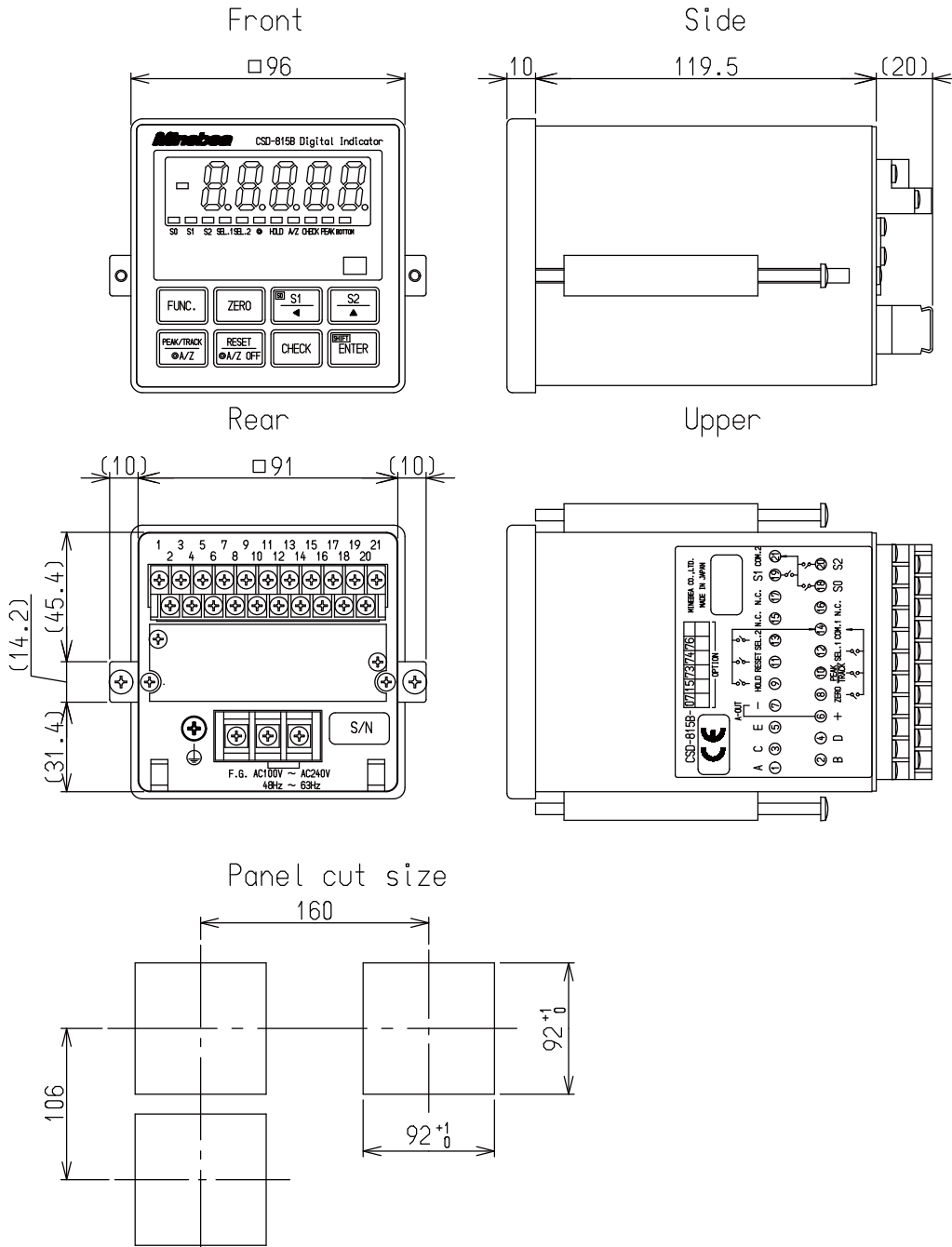

3-4. Applicable environment

Warning: The instrument may subject to use in a highly humid area or in full of powder dust.

In such a case, use the instrument by inserting the panel mount gasket attached between the control panel (cabinet) and the main body.

By inserting the panel mount gasket, the front panel section becomes IP65 (International Protection Code) or equivalent in dust-proof and water-proof construction.

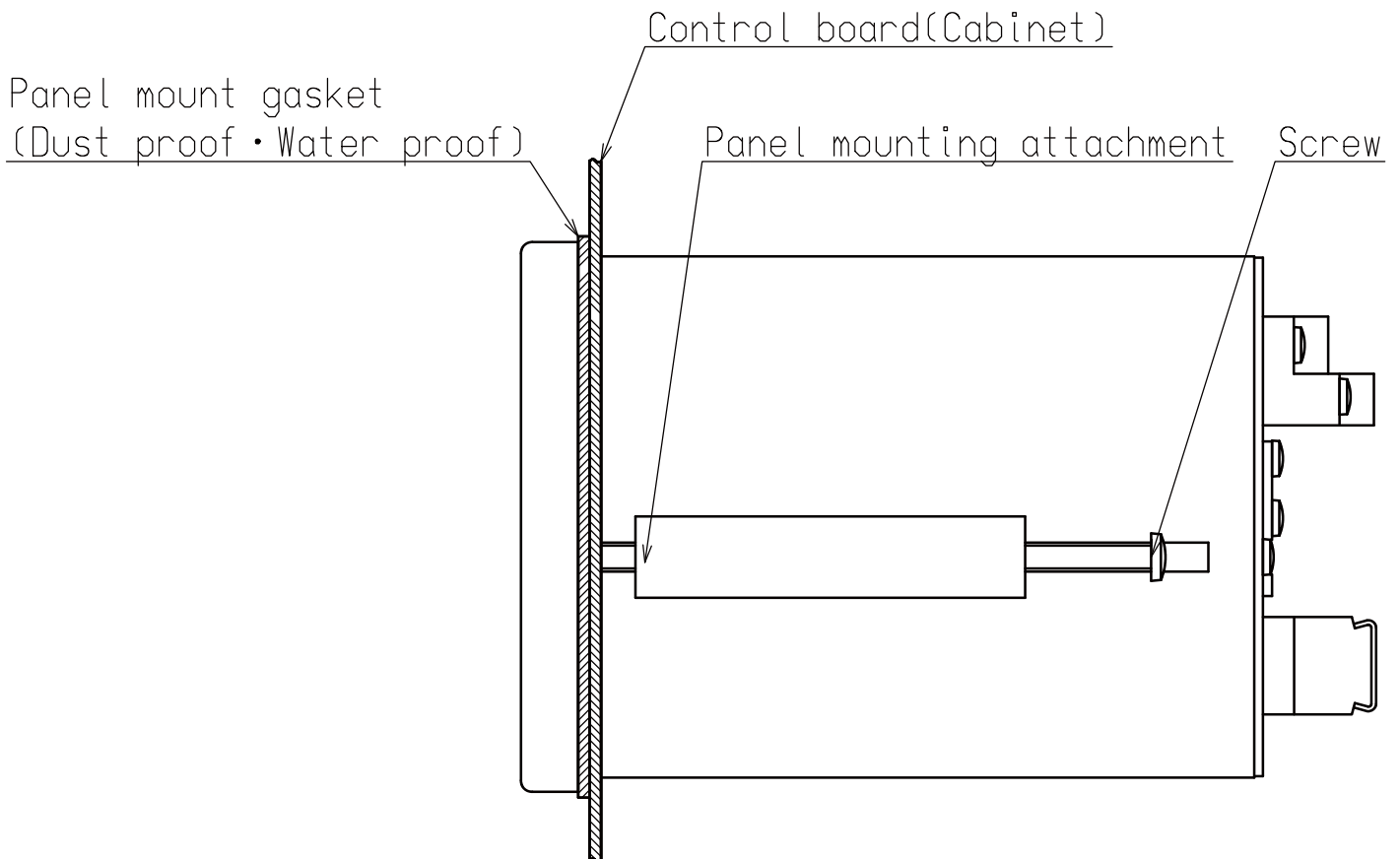

4. Connecting method

4-1. Layout of the terminal block

There are 2 pieces of terminal block and M4 thread, one has 21 points of terminals and the other has 3 points of terminals.

Layout of terminal blocks and thread are shown in the following figure. :

① Terminal block 1 (21P)

Terminal Nos.	Descriptions	Applications	Terminal Nos.	Descriptions	Applications
1	A	Strain gage applied transducer	11	RESET or A/Z OFF	External control input
2	B		12	SEL.1	
3	C		13	SEL.2	
4	D		14	COM.1	
5	E		15	N.C.	
6	A-OUT +	Analog output	16	N.C.	
7	A-OUT -		17	N.C.	
8	ZERO	External control input	18	S0	Contact output
9	HOLD		19	S1	
10	PEAK/TRACK or A/Z		20	S2	
			21	COM.2	

② Terminal block 2 (3P)

Name	Application
AC	Power supply
AC	
F.G.	Frame ground (Functional ground)

③ Protective earth terminal (M4 thread)

Name	Application
	Protective ground



● The COM.1(Terminal No.14) and COM.2(Terminal No.21) are isolated.

4-2. Note on connection



Warning ● In case of connection with the instrument, keep strictly to the following items. If neglected, it may cause an unexpected failure or a damage to the instrument.

- Be sure to set the power supply to OFF, when the connection will be made.
- Since the terminal boards at rear side of the instrument is made of resin, take care not to drop it down or not to apply strong impact.
- Recommended torque to tighten the terminal screws for terminal block should be as follows :

Terminal block	Torque to tighten the terminal screws
Terminal block 1	0.6 N·m
Terminal block 2	1.4 N·m
Protective earth terminal	1.4 N·m

- The suitable crimp type terminal lugs for the terminal board are as follows:

Terminal block	Width of crimp type terminal lugs	Suitable crimp type terminal lugs
Terminal block 1	6.2 mm or less	1.25-3 or Y type 1.25-3.5
Terminal block 2	9.0 mm or less	1.25-4, 2-4
Protective earth terminal		or Y type 1.25-4, 2-4

- Connecting cable with the instrument should be away from the noise source such as power supply line and/or I/O line for control and so on as far as possible.
- Conduit wiring should be the type of exclusive one, and avoid using with another line together.
- All of the connections should be executed securely by referring to the Instruction manual for the instrument.

4-3.Connection

4-3-1. Connection with strain gage applied transducers

The instrument can connect with strain gage applied transducers, such as load cell, pressure transducer and so on. Here, we will describe the example of connections with load cell, so the connection with another type of strain gage applied transducers shall be proceeded in the same way.



※1 When tension is applied with the application of tension type or universal(compression/tension) type of load cell, and display of “+” direction is required, connect “Green” with Terminal No.2 and “Blue” with Terminal No.4 individually. As there is a case which standard wiring color is different, please confirm the inspection data sheet of the load cell being used.

※2 When the length of CAB-502 is more than 30 m totally, there may have the case that the accuracy is out of warranty because the resistance of cable makes the input voltage of the instrument decreased.

① Connection with 1 piece of load cell and CSD-815B

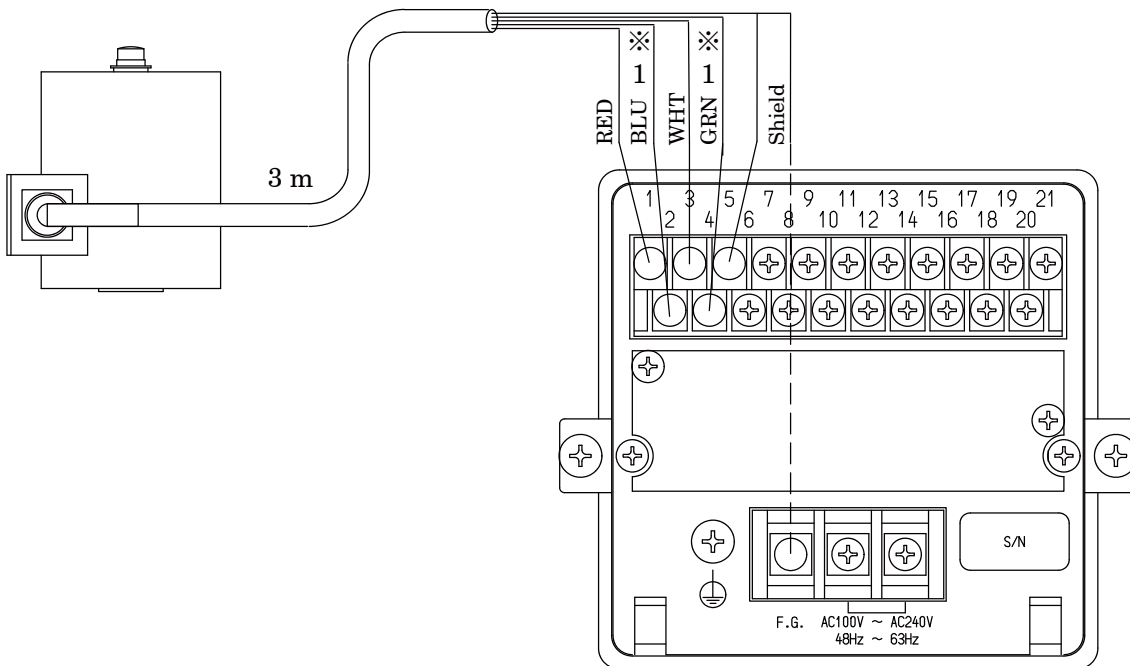

● When this instrument suits with the CE conformity standard, please connect the shielded wire with F.G. terminal (Terminal block 2 Terminal No.3).



※1 When tension is applied with the application of tension type or universal(compression/tension) type of load cell, and display of “+” direction is required, connect “Green” with Terminal No.2 and “Blue” with Terminal No.4 individually. As there is a case which standard wiring color is different, please confirm the inspection data sheet of the load cell being used.

※2 When the length of CAB-502 is more than 30 m totally, there may have the case that the accuracy is out of warranty because the resistance of cable makes the input voltage of the instrument decreased.

② Connection with 1 piece of load cell and Junction box for extension use(B-304) and CSD-815B

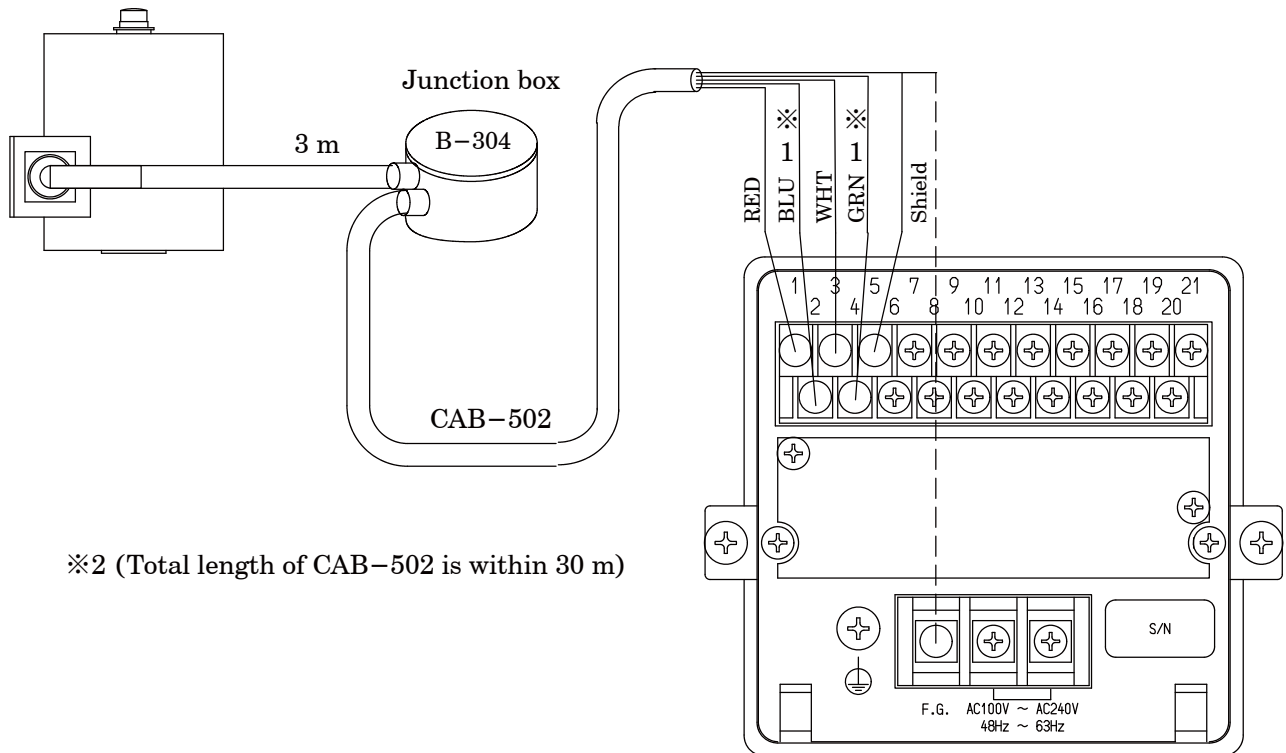

※2 (Total length of CAB-502 is within 30 m)

Internal wiring diagram of B-304

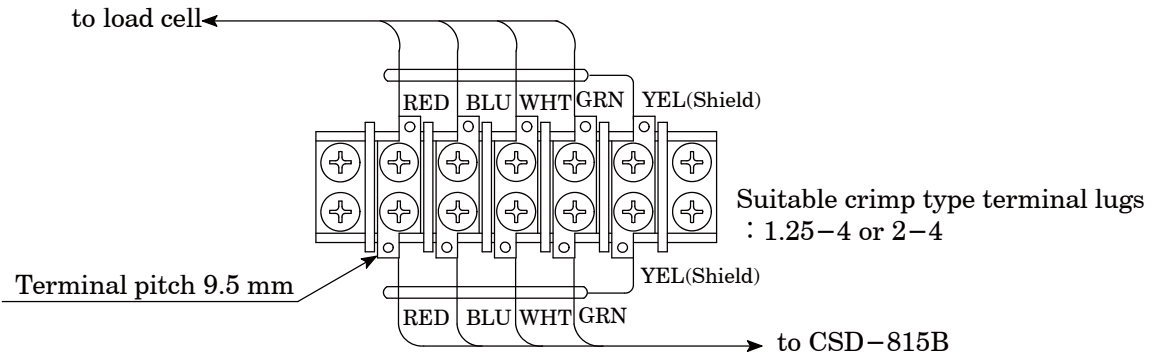

● When this instrument suits with the CE conformity standard, please connect the shielded wire with F.G. terminal (Terminal block 2 Terminal No.3).



※1 When tension is applied with the application of tension type or universal(compression/tension) type of load cell, and display of “+” direction is required, connect “Green” with Terminal No.2 and “Blue” with Terminal No.4 individually. As there is a case which standard wiring color is different, please confirm the inspection data sheet of the load cell being used.

※2 When the length of CAB-502 is more than 30 m totally, there may have the case that the accuracy is out of warranty because the resistance of cable makes the input voltage of the instrument decreased.

③ Connection with 2 to 4 pieces of load cells, Summing type junction box(SB-310) and CSD-815B

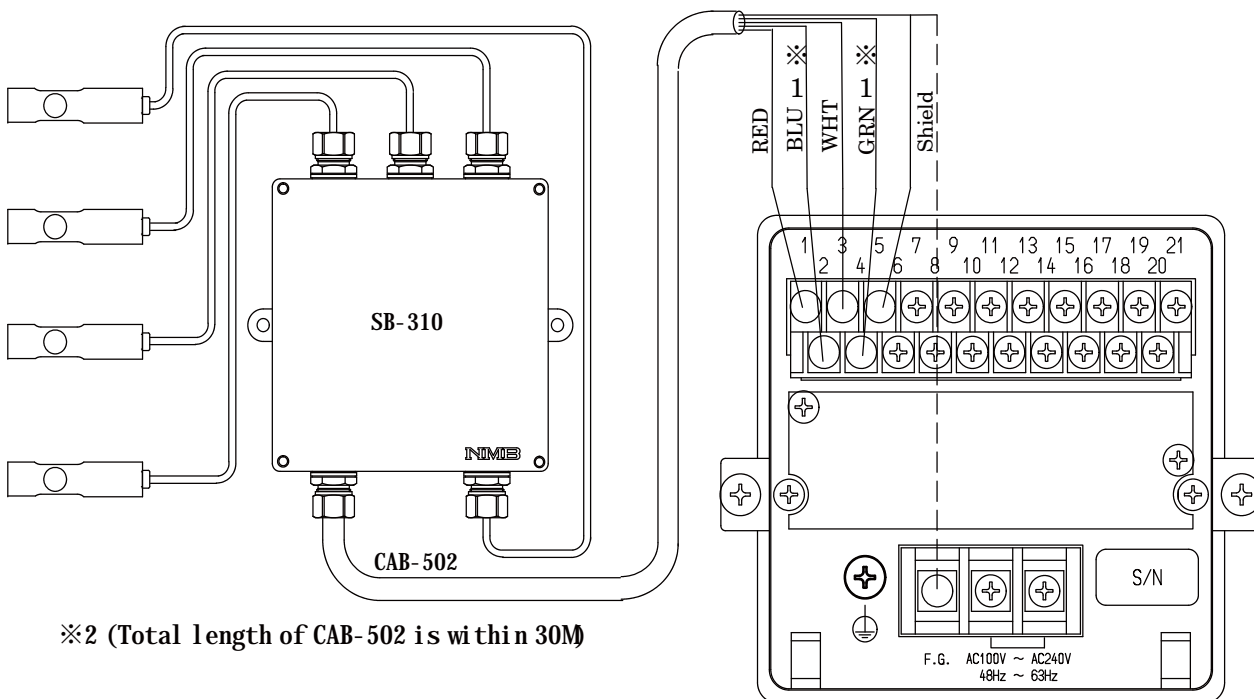

※2 (Total length of CAB-502 is within 30M)

Internal wiring diagram of SB-310

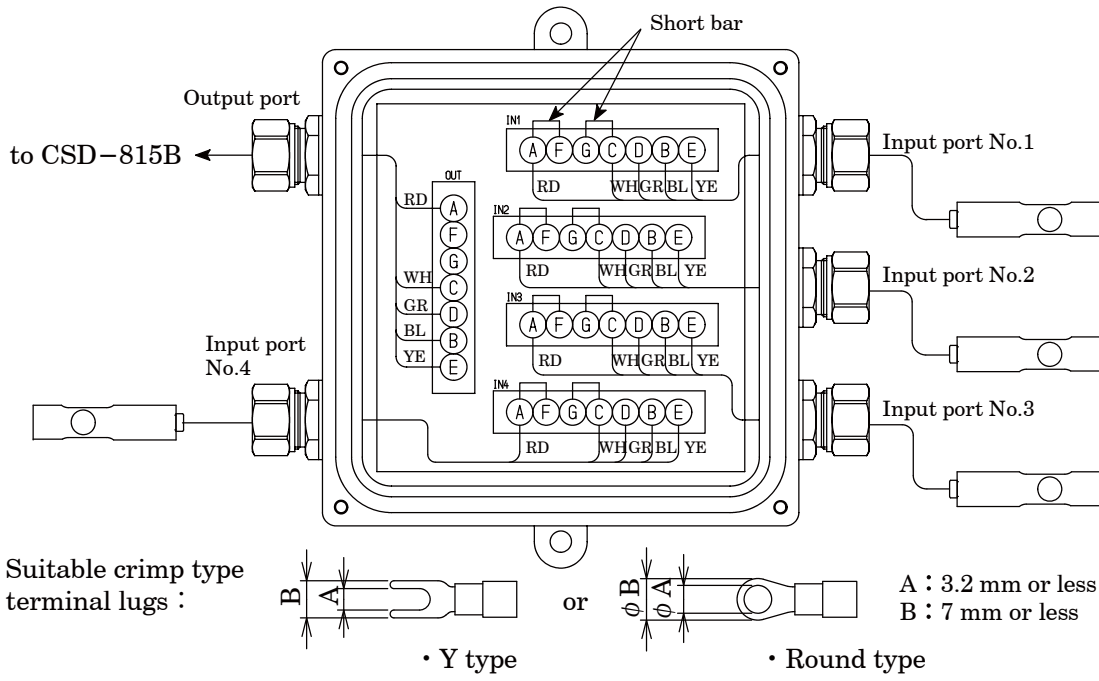



● When this instrument suits with the CE conformity standard, please connect the shielded wire with F.G. terminal (Terminal block 2 Terminal No.3).

4-3-2. Connection with external control inputs

Connections with external control input “ZERO”, “HOLD”, “PEAK/TRACK”, “RESET”, “SEL.1” and “SEL.2” should be made according to the below figures by using a contact or an open collector between the each terminal and terminal No. 14 at “COM.1”

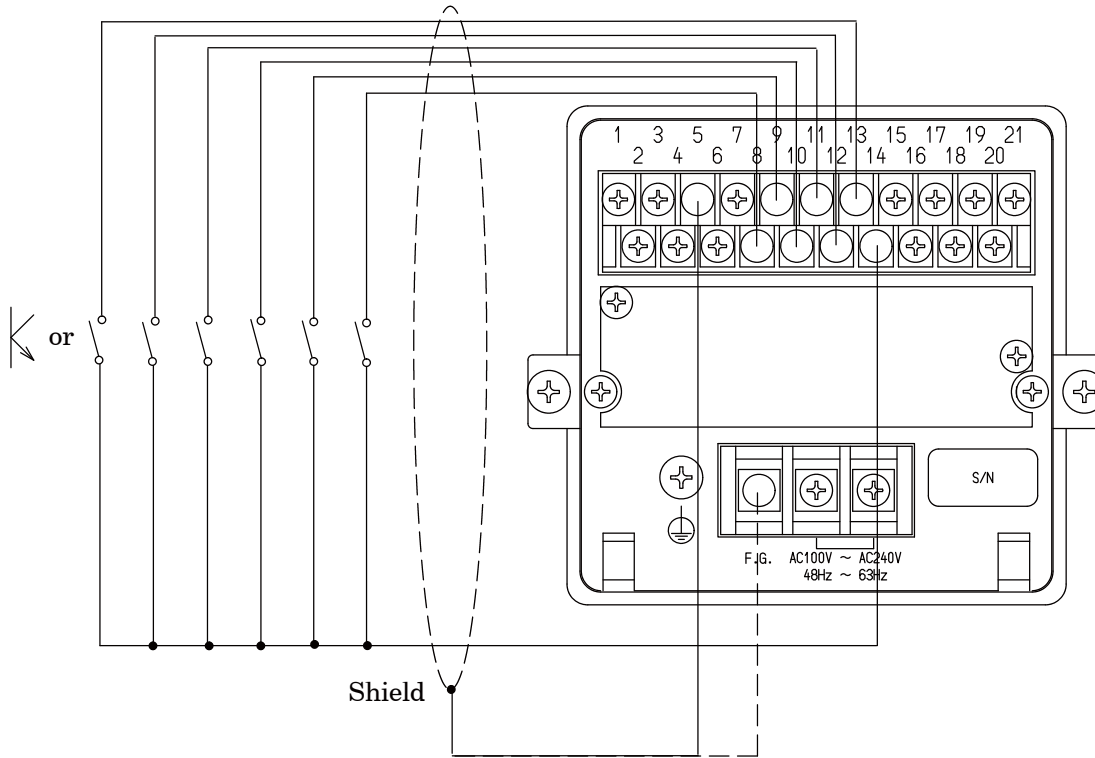
Refer to the paragraph 7-1 for the function of each input.



 **Warning** ● Connections with external control outputs should be made securely according to the figures. If neglected, it may cause an unexpected failure and/or malfunction to the instrument.

 ● For the connections with external control inputs, be sure to apply shielded cable, and the shielded cable should be connected with terminal E of the instrument.(Terminal No.5)
If not connected, it may cause malfunction due to the effects from external noises and so on.

● When this instrument suits with the CE conformity standard, please make the single earth with a protective ground terminal.

4-3-3. Connection with contact outputs

Connections with contact outputs “S0”, “S1” and “S2” and external load should be made by using each terminal and terminal No. 21 at “COM.2”.

At the same time, take care that the load should not exceed the rated load of contact output.

Rated load of contact output	AC125 V	0.1 A (Resistance load)
	DC30 V	0.5 A (Resistance load)

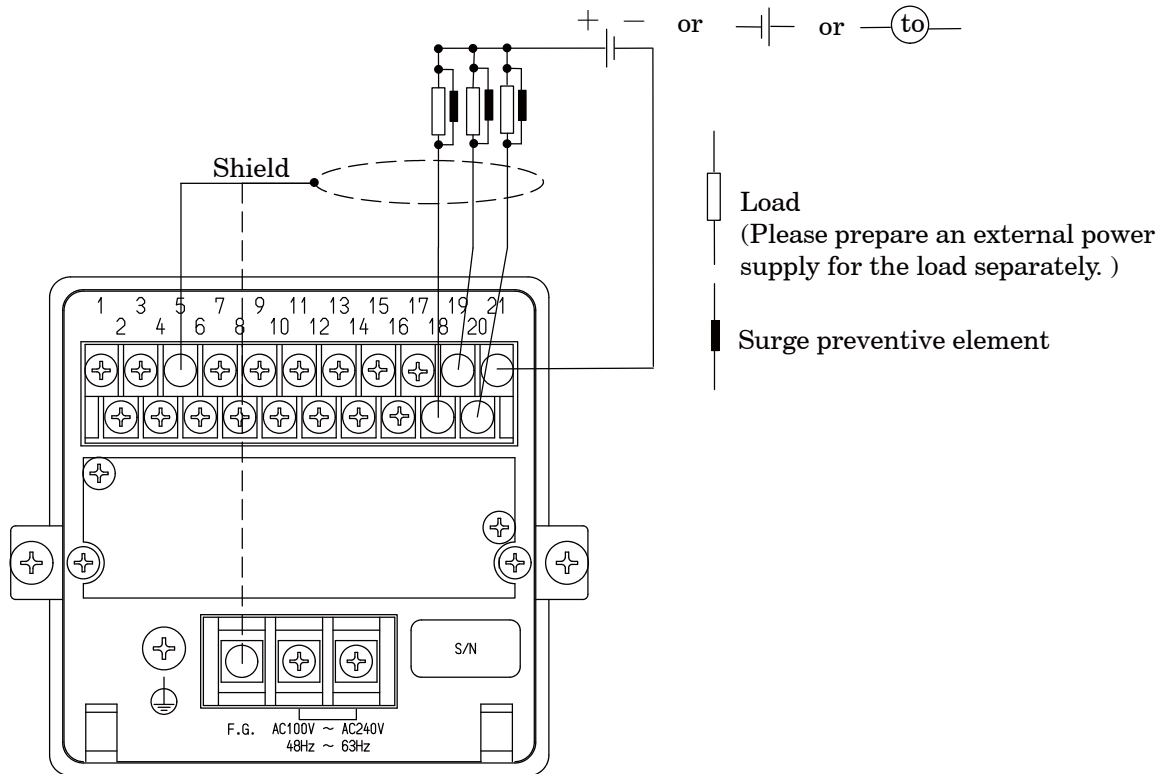



Warning

- Connections with contact outputs should be made securely according to the figures and also within the rated capacity of the instrument. If neglected, it may cause an unexpected failure and/or malfunction to the instrument.
- For the protection from the contact of the instrument, connect the surge preventive element that satisfies the characteristics of external load to connect. If neglected, it may cause unexpected failure and/or malfunction due to the effects from damage/melt down of the contact and so on.



- For the connections with contact outputs, be sure to apply shielded cable, and the shielded cable should be connected with E terminal of the instrument.(Terminal No.5)
If not connected, it may cause malfunction due to the effects from external noises and so on.
- When this instrument suits with the CE conformity standard, please connect the shielded wire with F.G. terminal (Terminal block 2 Terminal No.3).

4-3-5. Connection with analog outputs

(1) In case of standard instrument (voltage output)

The instrument prepares output voltage for analog outputs as a standard.
Connections with voltage output should be made as the following figure.

Voltage output	DC-10 V to 10 V	
Over-range	At “-OL” display	Approx. -11 V
	At “OL” display	Approx. 11 V
Load resistance	5 kΩ or more	

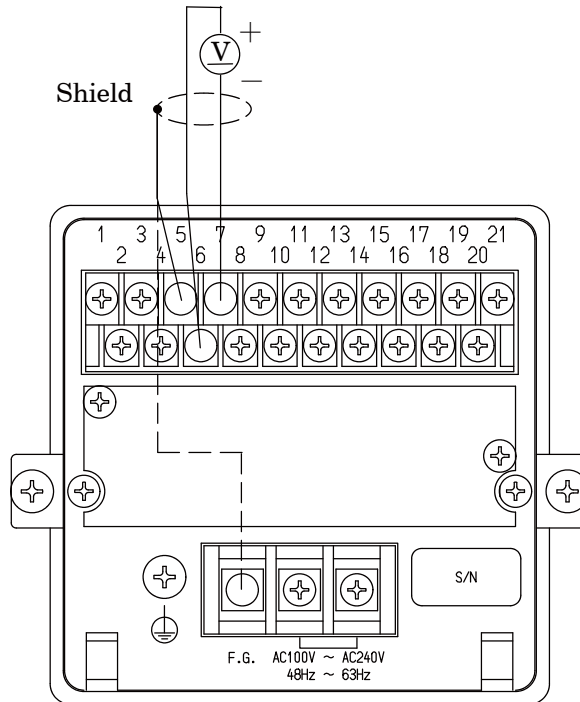

Warning ● Connections with voltage outputs should be made securely according to the figures and also within specified load resistance. If neglected, it may cause an unexpected failure and/or malfunction to the instrument.

- For the connections with voltage outputs, be sure to apply shielded cable, and the shielded cable should be connected with the E terminal of the instrument(Terminal No.5).
If not connected, it may cause malfunction due to the effects from external noises and so on.
- When this instrument suits with the CE conformity standard, please connect the shielded wire with F.G. terminal (Terminal block 2 Terminal No.3).

(2) In case of option (current output)

Connections with current output should be made as the following figure.

Current output	DC4 mA to 20 mA	
Over-range	At “-OL” display	Approx.2.4 mA
	At “OL” display	Approx.21.6 mA
Load resistance	260 Ω or less	

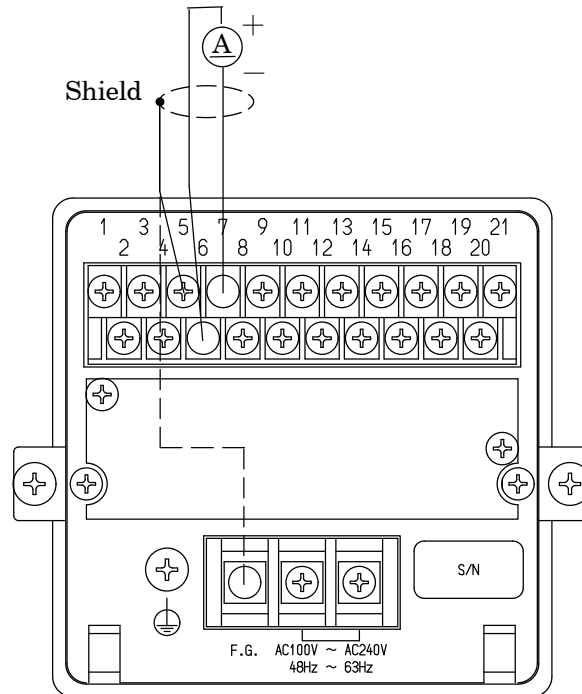

Warning ● Connections with current outputs should be made securely according to the figures and also within the specified load resistance. If neglected, it may cause an unexpected failure and/or malfunction to the instrument.



- For the connections with current outputs, be sure to apply shielded cable, and the shielded cable should be connected with the E terminal of the instrument.(Terminal No.5)
If not connected, it may cause malfunction due to the effects from external noises and so on.
- When this instrument suits with the CE conformity standard, please connect the shielded wire with F.G. terminal (Terminal block 2 Terminal No.3).

5. Calibration procedures

-  **Warning**
- Before using the new instrument or after exchanging the strain gage applied transducer with a new one, be sure to make calibration. If calibration is not made, correct measured results may not be obtained, or it may cause malfunction to the instrument and it may damage the peripheral equipment. Moreover, even if calibration has made, there may occur the similar case as above when the result is not correct. So make precise calibration again.
 - The calibration for the instrument and “Display value at the time of minimum analog output”(F-21) and “Display value at the time of maximum analog output” (F-22) are not interlocked. In due course, make check on the setting for F-21 and F-22 securely. If neglected, correct outputs may not be obtained, or it may cause malfunction to the instrument and it may damage the peripheral equipment.

5-1.Preparations

According to the Chapter 4. Connecting method, connect the instrument and the strain gage applied transducer properly, then supply the power.

5-2.Calibration procedures

Load calibration procedures for the instrument are as follows:

- ① Calibration method to register the output (conversion with mV/V) of strain gage applied transducer at the time of maximum display (weighing capacity) after setting the load to zero (Initial load condition with tare weight).
- ② Calibration method (Automatic calibration for Zero and Span) to register the output of strain gage applied transducer (conversion with mV/V) at the time of zero load(Initial load application with tare) at the optional load condition, and also to register the output (conversion with mV/V) of strain gage applied transducer at the time of maximum display (weighing capacity).
- ③ Calibration method (Actual load calibration) to register by the reading output of strain gage applied transducer, when setting in the condition of zero load applied (Initial load application with tare) and in the condition of actual load applied individually.
- ④ Fine adjustment on Zero
- ⑤ Fine adjustment on Span
- ⑥ Calibration procedures to apply registration again for zero point only(Tare weight cancellation).













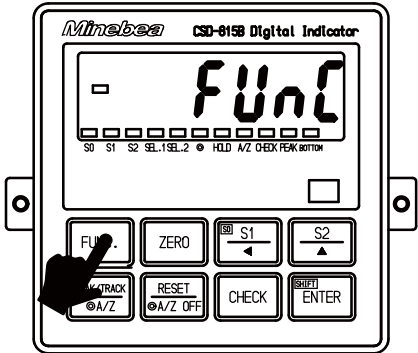

- The accuracy of calibration obtained from ① and ② is 1/1 000 or so.
If more than the accuracy 1/1 000 is required, make calibration of ③ type.

In the following paragraphs, we will describe each calibration procedure by showing the examples with load cell applied.

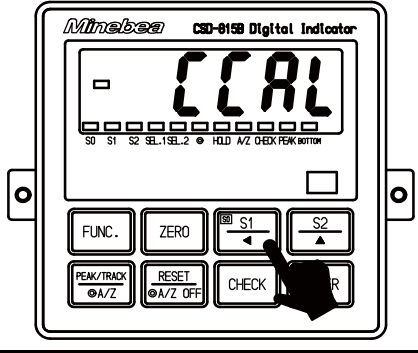
5-2-1. Calibration method to register the output of strain gage applied transducer at the time of maximum display after setting the load to zero.

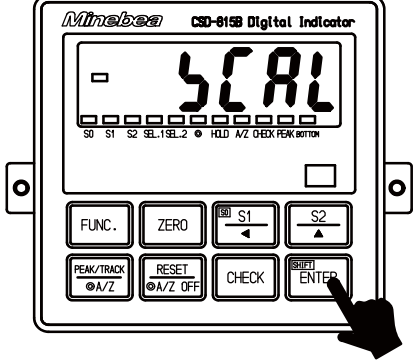
-  **Warning** ● Before using a new instrument or exchanging the strain gage applied transducer for a new one, be sure to make calibration.
- If calibration shall not be made, correct measured results may not be obtained nor it may cause malfunction in the instrument and there may exist damage to the peripheral equipment.
- Besides, even though the calibration has been made, there may occur the similar case when the result is not correct, so make calibration again.
- During the calibration is executing, be sure to set Tare weight cancellation clear, and to make cancellation (Execution of F-98) for compensated data on zero set and set the OFF position of Zero tracking (Setting “00000” on F-08 and F-09), and also set the OFF position Peak.
 - When the changeover target of the calibration data is set to the changeover by external control input (Setting of F-80 : “00001” or “00011”), execute the calibration after the changeover of the calibration data changed by the external control output (SEL.1 and SEL.2).

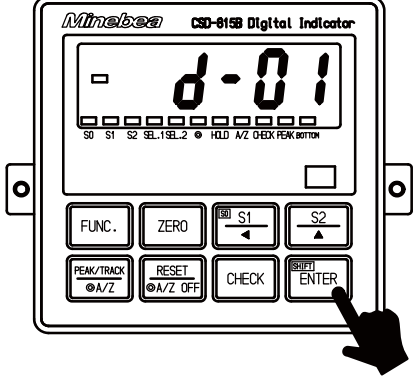
- 
- During calibration procedures, press the  key in case of interrupting the calibration is required. The calibration data will be kept as they are before entering the calibration and then returns to the Measurement mode.
 - Every time the  key is pressed with the load display of “FUNC”, the display will change as the following arrow marks. However, every time the  key is pressed, the display will change as the reverse direction of the following arrow marks.
“FUNC”→“CCAL”→“ACAL”→“LCAL”→“ZERO”→“SPAN”→
“TARE”→“TARE”→“CHEK”→“MONT”→“VCAL”→“VADJ”→
“FUNC”→“CCAL”→..... (Hereinafter, it will repeat.)

Procedures		
1	<p>Press the  key for approx. one second. The load display will show “FUNC”.</p>	
2	<p>Press the  key once. The load display will show “CCAL”.</p>	
3	<p>Press the  key. “CCAL” mode can be entered, then the load display will show “SCAL”.</p>	
4	<p>Press the  key. The load display shows “D-01” and it will flash on and off. When the calibration has completed already, the set value of minimum scale registered at that time will be displayed. Set the minimum scale with the right keys. Setting value for the minimum scale will be 4 (four) as follows: 1, 2, 5, 10</p>	 <p> key : Set value inclement key</p>

Procedures

5

Press the  key.
The load display will show "DISP".

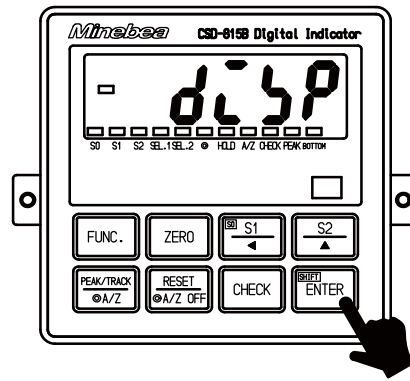

6

Press the  key.
The load display will show "2000", and the digit of minimum display will flash on and off.
When the calibration has completed already, the registered value of maximum display at that time will be displayed.







By the setting of minimum scale, the digit of minimum display that flashes on and off will be as follows :

The minimum scale 1, 2, 5 10^0 digit
The minimum scale 10 10^1 digit

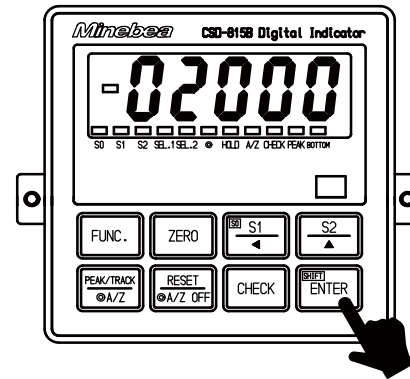
Set the maximum display value with the right keys. Setting range for the maximum display value will be (the minimum scale \times 100) to 99 990. In order to make effective use of the performance, set within the following ranges.
When setting is made over the range as below, there may have a possibility of unstable display and so on.

Setting range for the maximum display value	The minimum scale
100 to 10 000	1
200 to 20 000	2
500 to 50 000	5
1 000 to 99 990	10



-  key : Set value carry key
-  key : Set value increment key
-  key : Set value initialization key

7

Press the  key.
The load display will show "S MV".

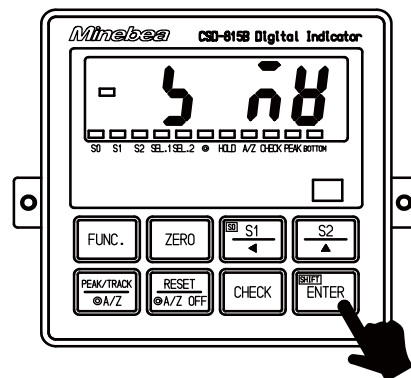



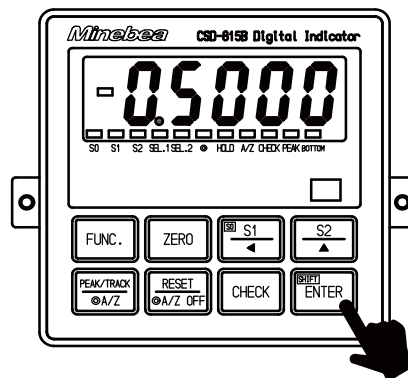

Procedures

Press the  key.
 The load display will show “0.5000”, and the digit of 10⁰ will flash on and off.
 In case that calibration has completed already, the registered output value of load cell at that time will be displayed. After the “ACAL” mode is over, the load display will show the present load. Set the given value with the right keys, which is subtracted the output value of load cell at the time of initial load application from the output value of load cell corresponding to the maximum display value set in the step 6.



8

 Though the number of digits has not prepared in the “Inspection data” for load cell so many as shown in the right figure, extra digits are necessary for the compensation with the standard point at internal of the instrument.
 In case of actual setting, insert “0”, into the extra digits.
 As for the value for extra digit, when tare compensation and fine adjustment on load are applied, it will be rewritten as a compensated value automatically.
 Setting range for the output of load cell is from 0.400 0 mV/V to 3.100 0 mV/V.

-  key : Set value carry key
-  key : Set value increment key
-  key : Set value initialization key

 By pressing the key continuously, increment can be provided continuously.

9

Press the  key.
 The load display will show “ZERO”.
 Here, set the instrument with initial load application.

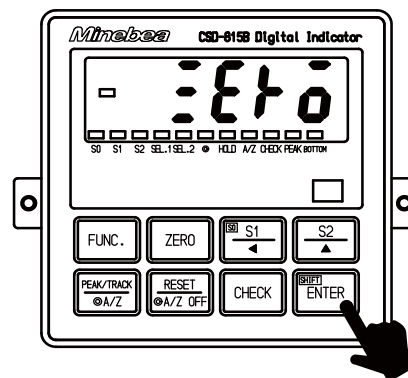

Procedures

10

Press the  key.
The load display will show “ZERO” with lighting display on and off, then zero adjustment can be started.

 **Warning** : At the same time, take care not to apply load variation due to vibration and so on. When load variation is applied, there will be possibilities that zero point is unstable, and precise reading of zero will not be obtained.

After completed, the load display will become “END”.
However, when the initial load is not entered within the range from -2.4 mV/V to 2.4 mV/V , the error code shown in the right figure will show for about 2 seconds, then load display will show “ZERO” and return to step 9.

- TE-L : Zero point - OVER
- TE-H : Zero point + OVER

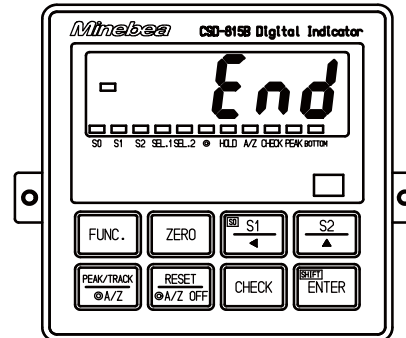
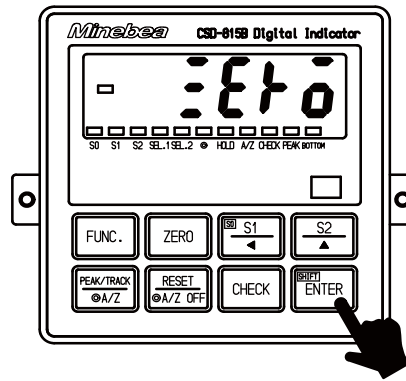

Error code



Error code



11

Press the  key.
After “CCAL” mode is over, the load display will show the present load.

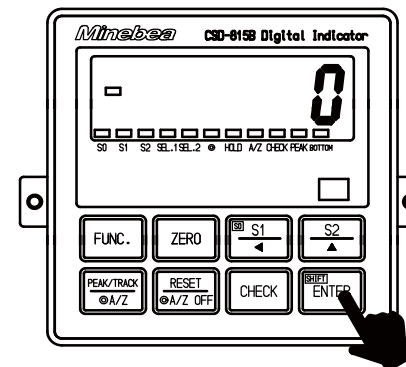

5-2-2. Calibration procedures to register the output of strain gage applied transducer at the time of zero and the maximum display



(1) Procedure by key operation











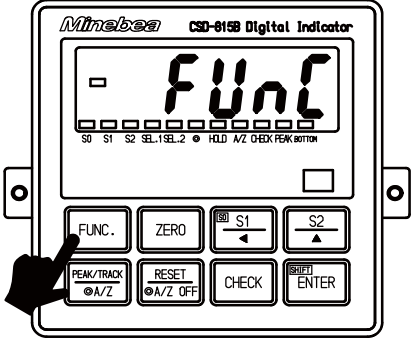

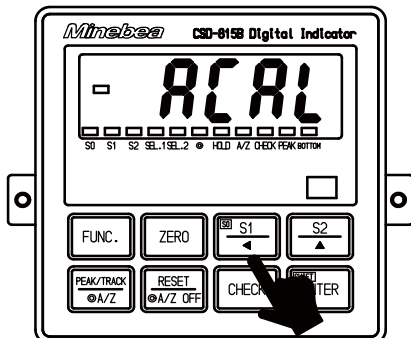

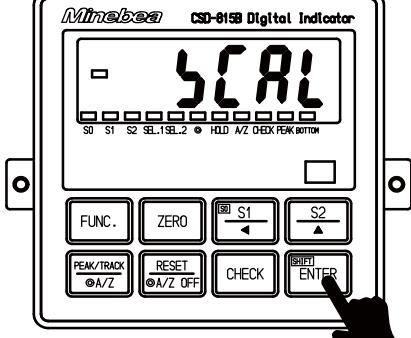

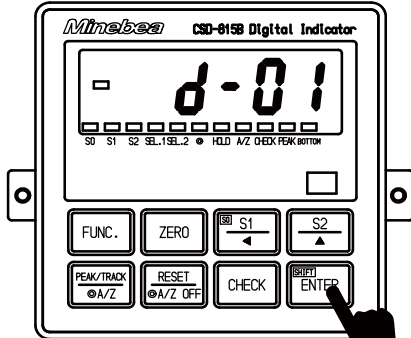

Warning

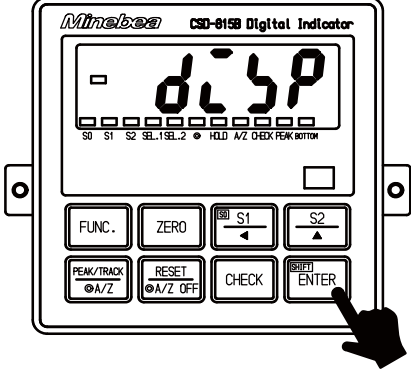
- Before using a new instrument or exchanging the strain gage applied transducer for a new one, be sure to make calibration.
If calibration shall not be made, correct measured results may not be obtained nor may cause malfunction in the instrument and there may exist damage in peripheral equipments.
Besides, even though calibration has been made, there may occur the similar case when the result is not correct, so make calibration again.
- During the calibration is executing, be sure to set Tare weight cancellation clear, and to make cancellation (Execution of F-98) for compensated data on zero set and set the OFF position of Zero tracking (Setting “00000” on F-08 and F-09), and also set the OFF position of Peak.
If neglected, correct measured results may not be obtained.
- When the changeover target of the calibration data is set to the changeover by external control input (Setting of F-80 : “00001” or “00011”), execute the calibration after the changeover of the calibration data changed by the external control output (SEL.1 and SEL.2).

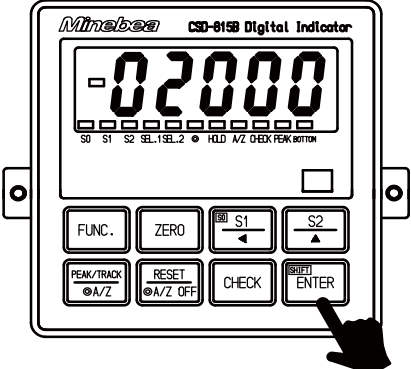

- During calibration procedures, press the  key in case of interrupting the calibration is required. The calibration data will be kept as they are before entering the calibration and then returns to the Measurement mode.
- Every time the  key is pressed with the load display of “FUNC”, the display will change as the following arrow marks. However, every time the  is pressed, the display will change as the reverse direction of the following arrow marks.
“FUNC”→“CCAL”→“ACAL”→“LCAL”→“ZERO”→“SPAN”→
“TARE”→“CHEK”→“MONT”→“VCAL”→“VADJ”→“FUNC”→
“CCAL”→..... (Hereinafter, it will repeat.)

Procedures		
1	Press the  key for about one second The load display will show "FUNC".	
2	Press the  key twice. It will make the load display proceed as "FUNC"→"CCAL"→"ACAL".	
3	Press the  key. "ACAL" mode can be entered, then the load display will show "SCAL".	
4	Press the  key. The load display shows "D-01" and it will flash on and off. When the calibration has completed already, the set value of minimum scale which has registered at that time will be displayed. Set the minimum scale with the right keys. Setting value for the minimum scale will be 4 (four) as follows : 1, 2, 5, 10	  key : Set value inclement key

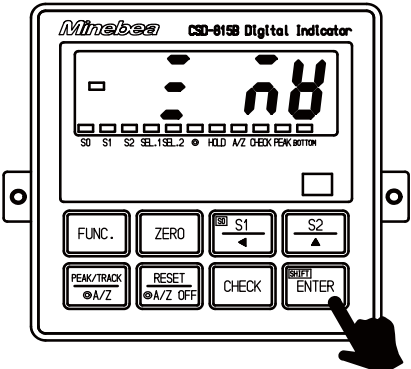
	Procedures											
5	<p>Press the  key. The load display will show “DISP”.</p>											
6	<p>Press the  key. The load display shows “2000” and the minimum display digit will flash on and off. When the calibration has completed already, the maximum display value which has registered at that time will be displayed.</p> <div data-bbox="233 768 842 958" style="border: 1px solid black; padding: 5px;"> <p> By the setting of minimum scale, the digit of minimum display that flashes on and off will be as follows :</p> <p>The minimum scale 1,2,5 10⁰ digit</p> <p>The minimum scale 10 10¹ digit</p> </div> <p>Set the maximum display value with the right keys. Setting range for the maximum display value will be (the minimum scale × 100) to 99 990. In order to make effective use of the performance, set within the following ranges. When setting is made over the range as below, there may have a possibility of unstable display and so on.</p> <table border="1" data-bbox="252 1223 831 1480"> <thead> <tr> <th>Setting range for the maximum display value</th> <th>The minimum scale</th> </tr> </thead> <tbody> <tr> <td>100 to 10 000</td> <td>1</td> </tr> <tr> <td>200 to 20 000</td> <td>2</td> </tr> <tr> <td>500 to 50 000</td> <td>5</td> </tr> <tr> <td>1 000 to 99 990</td> <td>10</td> </tr> </tbody> </table> <div data-bbox="233 1503 842 1603" style="border: 1px solid black; padding: 5px;"> <p> By pressing the key continuously, increment can be provided continuously.</p> </div>	Setting range for the maximum display value	The minimum scale	100 to 10 000	1	200 to 20 000	2	500 to 50 000	5	1 000 to 99 990	10	 <p> key : Set value carry key</p> <p> key : Set value increment key</p> <p> key : Set value initialization key</p>
Setting range for the maximum display value	The minimum scale											
100 to 10 000	1											
200 to 20 000	2											
500 to 50 000	5											
1 000 to 99 990	10											
7	<p>Press the  key. The load display will show “Z MV”.</p>											

Procedures



8

Press the  key.
 The load display will show "0.0000", and the digit of 10⁰ will flash on and off. In case that calibration has completed already, the registered output value of load cell at that time will be displayed.
 Set the output value for load cell with the initial load application with the right keys.

 Though the number of digits has not prepared in the "Inspection data" for load cell so many as shown in the right figure, extra digits are necessary for the compensation with the standard point at internal of the instrument.
 In case of actual setting, insert "0", into the extra digits.
 As for the value for extra digit, when tare compensation and fine adjustment on load are applied, it will be rewritten as a compensated value automatically.
 Setting range for the output of load cell is from -2.400 0 mV/V to 2.400 0 mV/V.

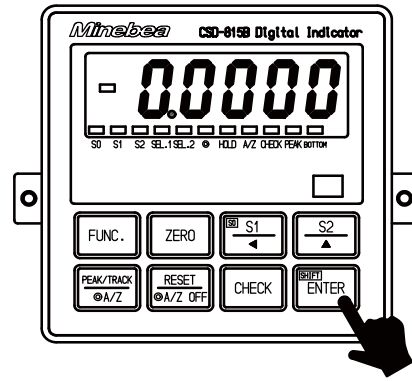
 By pressing the key continuously, increment can be provided continuously.









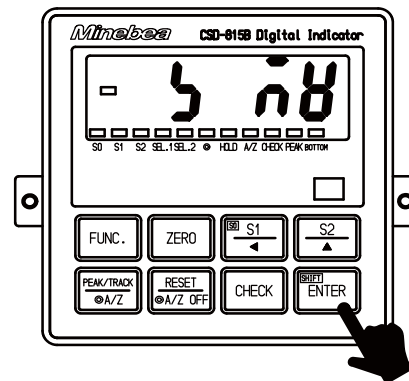

-  key : Set value carry key
-  key : Set value increment key
-  key : Set value initialization key

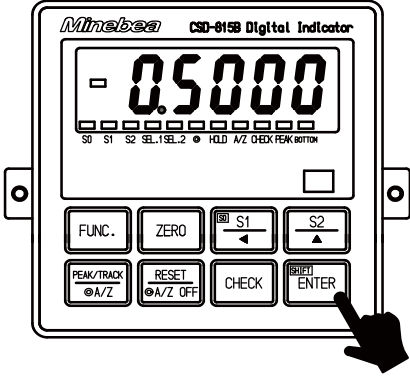
9

Press the  key.
 The load display will show "S MV".

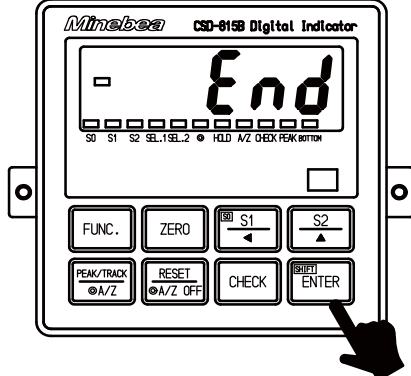

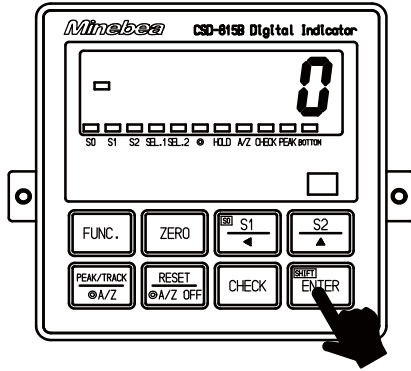









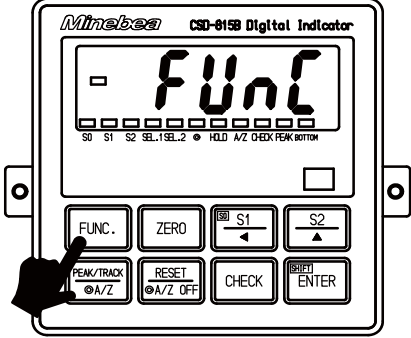

	Procedures	
10	<p>Press the  key. The load display will show “0.500 0” and the digit at 10⁰ will flash on and off. In case that calibration has completed already, the registered output value of load cell at that time will be displayed. Set the output value for load cell with the initial load application with the right keys.</p> <div data-bbox="229 439 839 922" style="border: 1px solid black; padding: 5px;"> <p> The set value to be set here should be 0.4 mV/V or more than the set value in the step 8. Though the number of digits has not prepared in the Inspection data for load cell as many as the digits in the right figure, extra digits are necessary for the compensation for the internal standard point of the instrument. In case of actual setting, insert “0” into the extra digits. As for the value of extra digits, when tare compensation and fine adjustment on load are applied, it will be written as a compensated value automatically.</p> </div> <div data-bbox="229 943 839 1050" style="border: 1px solid black; padding: 5px;"> <p> By pressing the key continuously, increment can be provided continuously.</p> </div>	 <p> key : Set value carry key  key : Set value increment key  key : Set value initialization key</p>
11	<p>Press the  key. The load display will show the “END”.</p>	
12	<p>Press the  key. After “ACAL” mode is over, the load display will show the present load.</p>	

5-2-3. Calibration method to register by reading output value of strain gage applied transducer in the conditions of zero/actual load application individually.

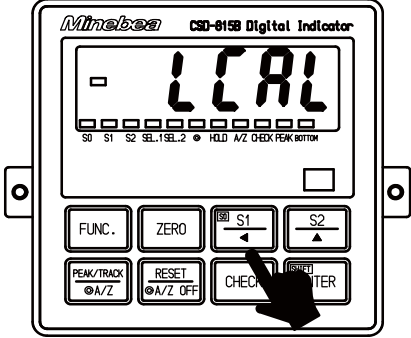
(1) Procedures by the key operation

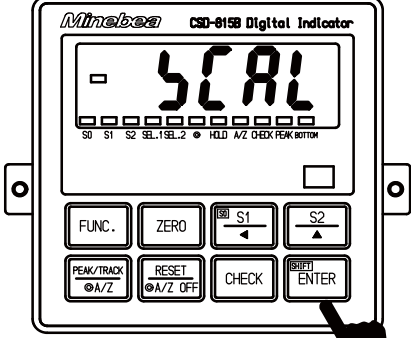
-  **Warning** ● Before using a new instrument or exchanging the strain gage applied transducer for a new one, be sure to make calibration.
- If calibration shall not be made, correct measured results may not be obtained nor may cause malfunction in the instrument and there may exist damage in peripheral equipments.
- Besides, even though calibration has been made, there may occur the similar case when the result is not correct, so make calibration again.
- During the calibration is executing, be sure to set Tare weight cancellation clear, and to make cancellation (Execution of F-98) for compensated data on zero set and set the OFF position of Zero tracking (Setting “00000” on F-08 and F-09), and also set the OFF position of Peak.
 - When the changeover target of the calibration data is set to the changeover by external control input (Setting of F-80 : “00001” or “00011”), execute the calibration after the changeover of the calibration data changed by the external control output (SEL.1 and SEL.2).

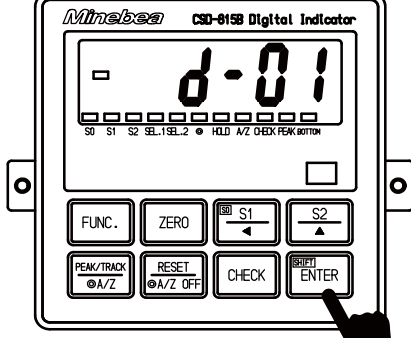
-  ● During calibration procedures, press the  key in case of interrupting the calibration is required. The calibration data will be kept as they are before entering the calibration and then returns to the Measurement mode.
- Every time the  key is pressed with the load display of “FUNC”, the display will change as the following arrow marks. However, every time the  is pressed, the display will change as the reverse direction of the following arrow marks.
“FUNC”→“CCAL”→“ACAL”→“LCAL”→“ZERO”→“SPAN”→
“TARE”→“CHEK”→“MONT”→“VCAL”→“VADJ”→“FUNC”→
“CCAL”→..... (Hereinafter, it will repeat.)

	Procedures	
1	Press the  key for about one second. The load display will show "FUNC".	
2	Press the  key three times. It will make the load display proceed as "FUNC"→"CCAL"→"ACAL"→"LCAL".	
3	Press the  key. "LCAL" mode can be entered, then the load display will show "SCAL".	
4	Press the  key. The load display shows "D-01" and it will flash on and off. When the calibration has completed already, the set value of minimum scale registered at that time will be displayed. Set the minimum scale with the right keys. Setting value for the minimum scale will be 4 (four) as follows : 1, 2, 5, 10	  key : Set value increment key

Procedures

5

Press the  key.
The load display will show “DISP”.

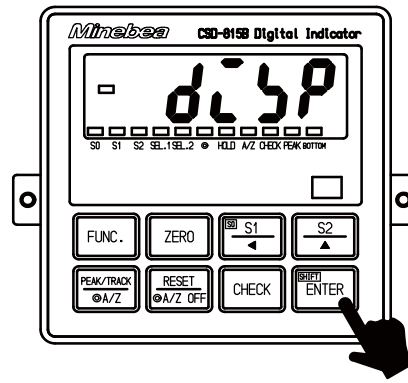

6

Press the  key.
The load display shows “2000” and the minimum display digit will flash on and off.
When the calibration has completed already, the maximum display value which has registered at that time will be displayed.

 By the setting of minimum scale, the digit of minimum display that flashes on and off will be as follows :



The minimum scale	1,2,5	10 ⁰ digit
The minimum scale	10	10 ¹ digit





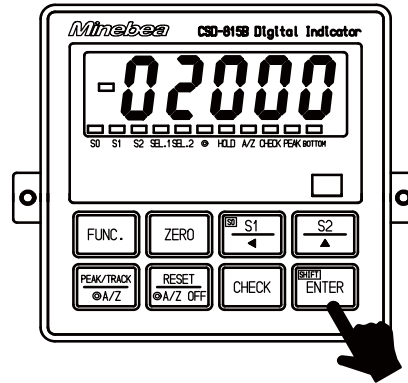



Set the maximum display value with the right keys. Setting range for the maximum display value will be (the minimum scale × 100) to 99 990.
In order to make effective use of the performance, set within the following ranges.
When setting is made over the range as below, there may have a possibility of unstable display and so on.

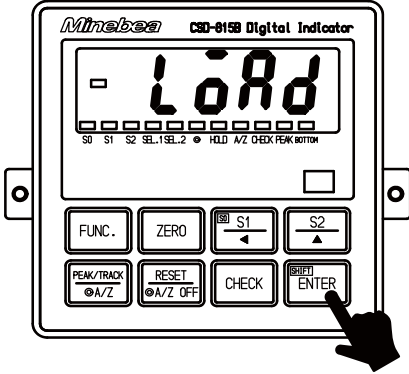

Setting range for the maximum display value	The minimum scale
100 to 10 000	1
200 to 20 000	2
500 to 50 000	5
1 000 to 99 990	10

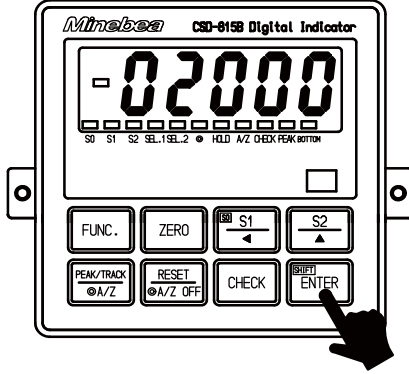
 By pressing the key continuously, increment can be provided continuously.

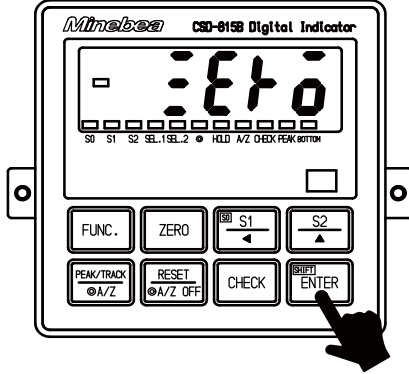

-  key : Set value carry key
-  key : Set value increment key
-  key : Set value initialization key

Procedures								
7	<p>Press the  key. The load display will show "LOAD".</p>							
8	<p>Press the  key. The load display will show "2000", and the digit of 10^0 will flash on and off. In case that calibration has completed already, the registered output value of load cell at that time will be displayed.</p> <div data-bbox="233 779 842 967" style="border: 1px solid black; padding: 5px;"> <p> By the setting of minimum scale, the digit of minimum display that flashes on and off will be as follows :</p> <table border="0"> <tr> <td>The minimum scale</td> <td>1,2,5</td> <td>10^0 digit</td> </tr> <tr> <td>The minimum scale</td> <td>10</td> <td>10^1 digit</td> </tr> </table> </div> <p>Set the actual load value going to apply on the load cell with the right keys. The load value applied on the load cell should be less than the maximum display value set in the step 6 and should be the maximum load that can apply on the load cell with the range of (the minimum scale $\times 100$) to 99 999 as well.</p> <div data-bbox="233 1205 842 1312" style="border: 1px solid black; padding: 5px;"> <p> By pressing the key continuously, increment can be provided continuously.</p> </div>	The minimum scale	1,2,5	10^0 digit	The minimum scale	10	10^1 digit	 <p> key : Set value carry key</p> <p> key : Set value increment key</p> <p> key : Set value initialization key</p>
The minimum scale	1,2,5	10^0 digit						
The minimum scale	10	10^1 digit						
9	<p>Press the  key. The load display will show "ZERO". Here, set the initial load application.</p>							

Procedures	
<p>10</p>	<p>Press the  key. The “ZERO” on load display will flash on and off, and zero adjustment can be started.</p> <div data-bbox="119 571 726 795" style="border: 1px solid black; padding: 5px;"> <p> Warning : Take care not to apply load variations due to vibrations and so on. If load variation is applied, the zero point will not be stabilized, in due course there is a possibility that correct reading of zero won't be obtained.</p> </div> <p>When completed, the display on the load display will show “SPAN”.</p> <p>However, when the initial load is not entered the range of -2.4 mV/V to 2.4 mV/V, the right Error code will be shown for about 2 seconds, then the display on the load display section will be shown as “ZERO”, and then the step 9 can be entered.</p> <p>TE-L : Zero point $-$OVER TE-H : Zero point $+$OVER</p>
<p>11</p>	<p>Apply the same load on the load cell as set in the step 8.</p>

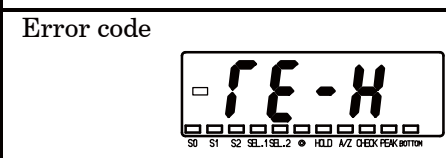
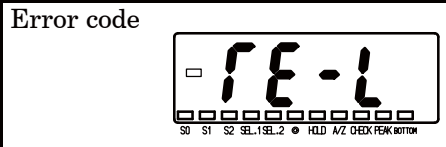
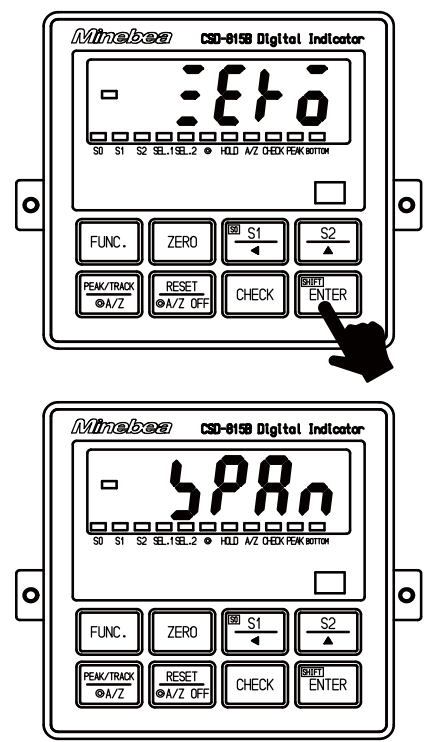

Procedures

Press the  key.
The “SPAN” on the load display will flash on and off, and span adjustment can be started.

 **Warning** : Take care not to apply load variations due to vibrations and so on. If load variation is applied, in due course there is a possibility that correct reading of span won't be obtained.

When completed, the display on the load display will show “END”.
However, when the value corresponding to the maximum display value does not satisfy the range from 0.4 mV/V to 3.1 mV/V, the right Error code will light up for about 2 seconds, then the display on the load display section will show “SPAN”, and then returns to the step 10.

SP-L : Span point - OVER
SP-H : Span point + OVER

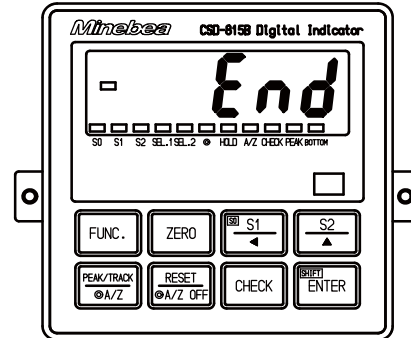
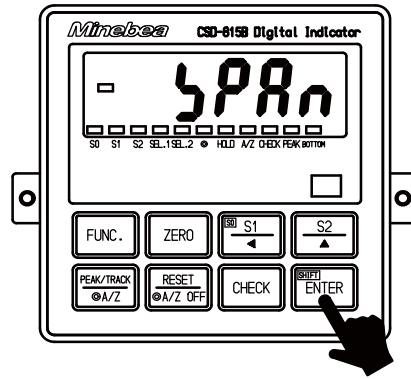

Error code

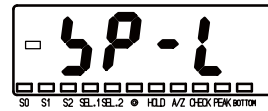

Error code



Press the  key.
After “LCAL” mode is over, the load display will show the present load.

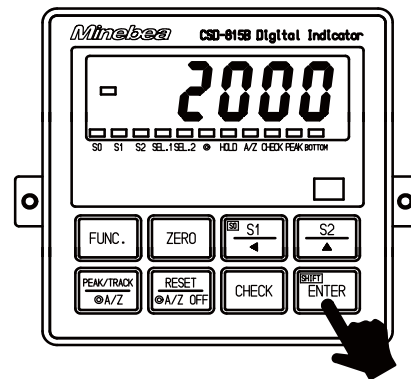



12









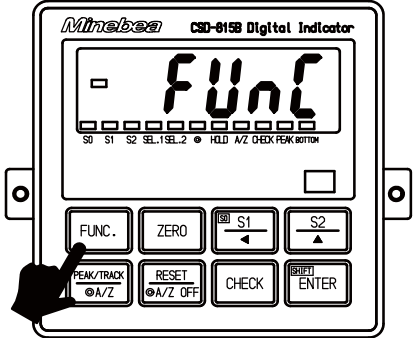

13

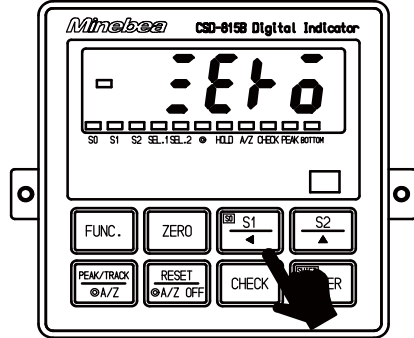
5-2-4. Zero fine adjustment

(1) Procedures by key operation

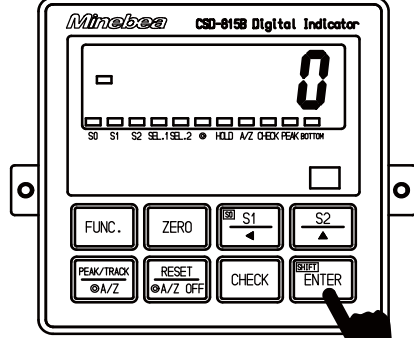

- During the Tare weight cancellation(A/Z) or Zero set is executed, and also during effective for Zero tracking and Peak ON, Zero fine adjustment mode can't be entered into. (Displays ER-5.)
The Zero fine adjustment can be entered after Tare weight cancellation clear(A/Z OFF), cancellation of the Compensated data at Zero set (Execution of F-98), set OFF the Zero tacking (Set the F-08 and F-09 to "00000".) and set the Peak OFF.
- When the changeover target of the calibration data is set to the changeover by external control input (Setting of F-80 : "00001" or "00011"), execute the calibration after the changeover of the calibration data changed by the external control output(SEL.1 and SEL.2).
- During the calibration procedure, press the  key to interrupt the calibration. The calibration data will keep the same condition as it is entered before, then returns to the Measurement mode.
- When the  key is pressed with the load display of "FUNC", the display will change as the following arrow marks indicate at every time the key is pressed. However, every time the  is pressed, the display will change as the reverse direction of the following arrow marks.
"FUNC"→"CCAL"→"ACAL"→"LCAL"→"ZERO"→"SPAN"
→"TARE"→"CHEK"→"MONT"→"VCAL"→"VADJ"→"FUNC"
→"CCAL"→.....(Hereinafter, it will repeat.)

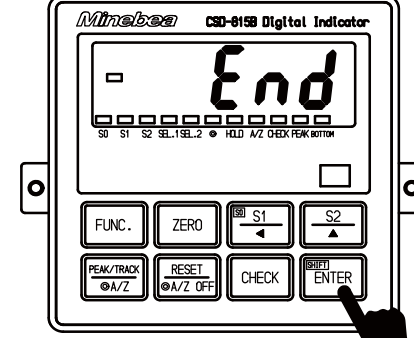
	Procedures	
1	Press the  key for about one second. The load display will show “FUNC”.	
2	Press the  key four times. It will make the load display proceeded as “FUNC”→“CCAL”→“ACAL”→“LCAL”→“ZERO”. Here, set the initial load application.	
3	Press the  key. Zero fine adjustment mode can be entered, then the display on load display will show the present load value and lights on and off. At the same time, set the present load value to “0” with the right keys. <div data-bbox="236 1115 837 1227" style="border: 1px solid black; padding: 5px; margin-top: 10px;">  By pressing the key continuously, increment can be provided continuously. </div> <div data-bbox="236 1249 837 1440" style="border: 1px solid black; padding: 5px; margin-top: 10px;">  The variation of load value for one push of the right key is less than 1 digit of display. Therefore, a few pushes of these keys are required to get the change of 1 digit of display value. </div>	 <div data-bbox="874 1305 1289 1384" style="margin-top: 10px;">  key : Zero fine adjustment display decreasing key </div> <div data-bbox="874 1395 1289 1473" style="margin-top: 10px;">  key : Zero fine adjustment display increasing key </div>
4	Press the  key. The indication of load display will show “END”.	

Procedures

5

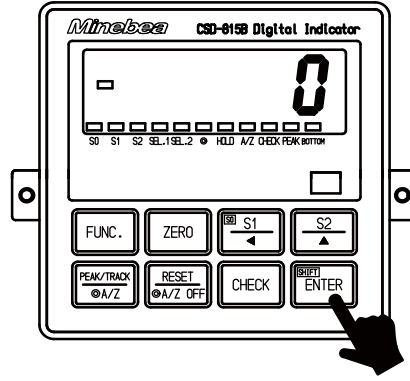

Press the  key.
After quitting from zero fine adjustment mode,
the load display will show the present load value.











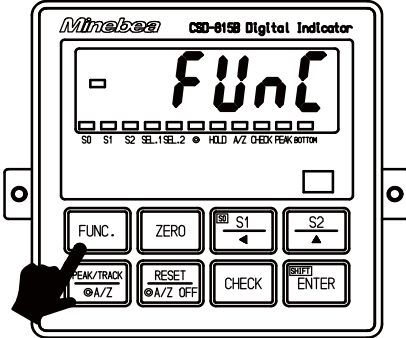

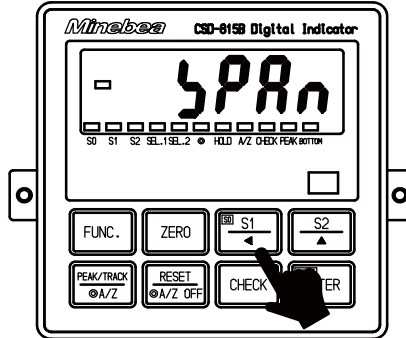

5-2-5. Span fine adjustment

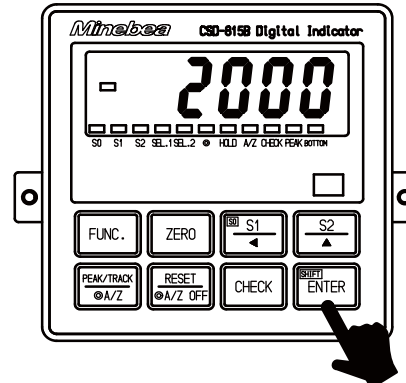
(1) Procedures by key operation

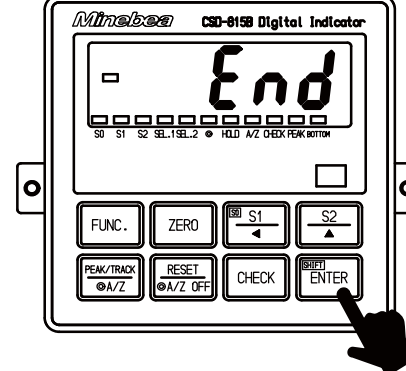

- During the Tare weight cancellation(A/Z) or Zero set is executed, and also during effective for Zero tracking and Peak ON, Span fine adjustment mode can't be entered into. (Displays ER-5.)
The Span fine adjustment can be entered after Tare weight cancellation clear(A/Z OFF), cancellation of the Compensated data at Zero set (Execution of F-98), set OFF the Zero tacking (Set the F-08 and F-09 to "00000".) and set the Peak OFF.
- When the changeover target of the calibration data is set to the changeover by external control input (Setting of F-80 : "00001" or "00011"), execute the calibration after the changeover of the calibration data changed by the external control output(SEL.1 and SEL.2).
- During the calibration procedure, press  key to interrupt the calibration. The calibration data will keep the same condition as it is entered before, then returns to the Measurement mode.
- When the  key is pressed with the load display of "FUNC", the display will change as the following arrow marks indicate at every time the key is pressed. However, every time the  is pressed, the display will change as the reverse direction of the following arrow marks.
"FUNC"→"CCAL"→"ACAL"→"LCAL"→"ZERO"→"SPAN"
→"TARE"→"CHEK"→"MONT" →"VCAL"→"VADJ"→"FUNC"
→"CCAL"→.....(Hereinafter, it will repeat.)

Procedures		
1	<p>Press the  key for about one second. The load display will show "FUNC".</p>	
2	<p>Press the  key five times. It will make the load display proceeded as "FUNC"→"CCAL"→"ACAL"→"LCAL"→"ZERO"→"SPAN". Here, set the maximum load that can be applied within the maximum value on the load cell.</p>	
3	<p>Press the  key. Span fine adjustment mode can be entered, then the display on load display will show the present load value and lights on and off. At the same time, adjust the present load value to be the same load applied on the load cell with the right keys.</p> <div data-bbox="119 1120 726 1232" style="border: 1px solid black; padding: 5px;">  By pressing the key continuously, increment can be provided continuously. </div> <div data-bbox="119 1243 726 1456" style="border: 1px solid black; padding: 5px;">  The variation of load value for one push of the right key is less than 1 digit of display. Therefore, a few pushes of these keys are required to get the change of 1 digit of display value. </div>	 <p> key : Span fine adjustment display decreasing key</p> <p> key : Span fine adjustment display increasing key</p>
4	<p>Press the  key. The indication of load display will show "END".</p>	



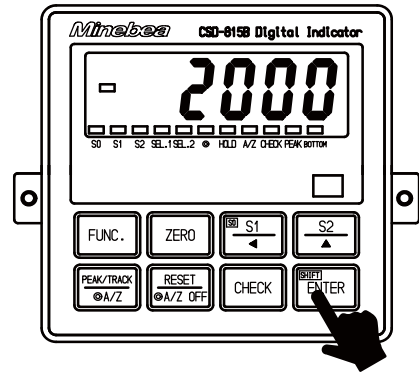

Procedures	
5	<p>Press the  key.</p> <p>After quitting from Span fine adjustment mode, the load display will show the present load value.</p>









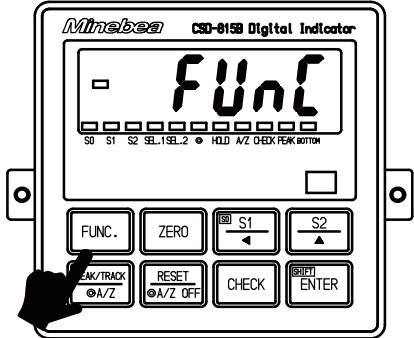

5-2-6. Calibration procedure to apply registration again for zero point only

(1) Procedures by key operation

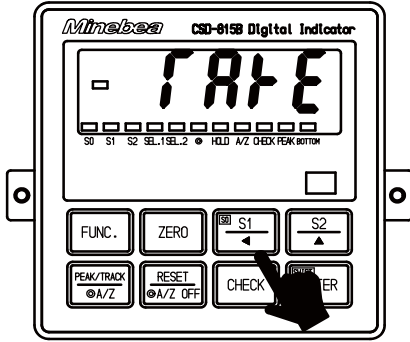
-  **Warning**
- During the execution of calibration, be sure to set the Tare weight cancellation clear, cancellation of the Compensated data at Zero set (Execution of F-98), and set OFF the Zero tacking (Set the F-08 and F-09 to “00000”.) and set the Peak OFF.
 - When the changeover target of the calibration data is set to the changeover by external control input (Setting of F-80 : “00001” or “00011”), execute the calibration after the changeover of the calibration data changed by the external control output(SEL.1 and SEL.2).

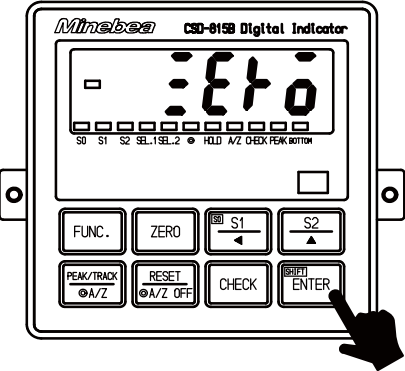
- 
- During the calibration procedure, press the  key to interrupt the calibration. The calibration data will keep the same condition as it is entered before, then returns to the Measurement mode.
 - When the  key is pressed with the load display of “FUNC”, the display will change as the following arrow marks indicate at every time the key is pressed. However, every time the  is pressed, the display will change as the reverse direction of the following arrow marks.
 “FUNC”→“CCAL”→“ACAL”→“LCAL”→“ZERO”→“SPAN”
 →“TARE”→“CHEK”→“MONT” →“VCAL”→“VADJ”→“FUNC”
 →“CCAL”→.....(Hereinafter, it will repeat.)

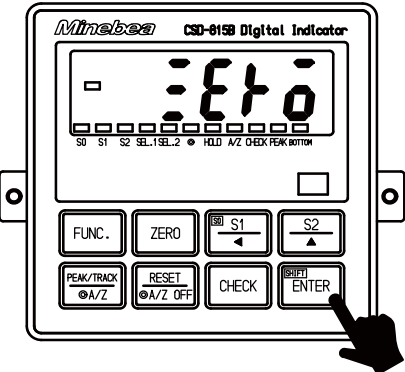
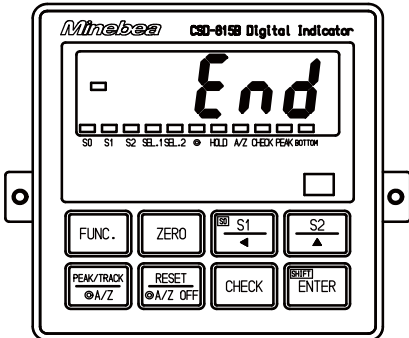
Procedures	
1	<p>Press the  key for about one second. The load display will show “FUNC”.</p> 

	Procedures	
2	<p>Press the  key six times. It will make the load display proceeded as “FUNC”→“CCAL”→“ACAL”→“LCAL”→“ZERO”→“SPAN”→“TARE”.</p> <p>Here, set the initial load application.</p>	
3	<p>Press the  key. The “TARE” mode can be entered. The display on the load display section will show “ZERO”.</p>	
4	<p>Press the  key. The display of “ZERO” on the load display section will flash on and off, and Tare weight cancellation will be entered.</p> <div data-bbox="233 1357 847 1581" style="border: 1px solid black; padding: 5px; margin: 10px 0;"> <p> Warning : At the same time, care should be taken not to apply load variation due to vibration and so on. If load variation is applied, zero point becomes unstable, so there is a possibility that correct zero can't be read.</p> </div> <p>When completed, the indication of load display will show “END”.</p> <p>However, when the initial load isn't entered within the range of -2.4 mV/V and 2.4 mV/V, the error code in the right will be shown for about 2 seconds, then the display on the load display will show “TARE”, and returns to the step 2.</p>	  <p>Error code</p> 

Procedures	
4	<p>When completed, the indication of load display will show “END”.</p> <p>However, when the initial load isn’t entered within the range of -2.4 mV/V and 2.4 mV/V, the error code in the right will be shown for about 2 seconds, then the display on the load display will show “TARE”, and returns to the step 2.</p> <p>TE-L : Zero point -OVER TE-H : Zero point +OVER</p>
5	<p>Press the  key.</p> <p>After quitting from the “TARE” mode, the load display will show the present load value.</p>

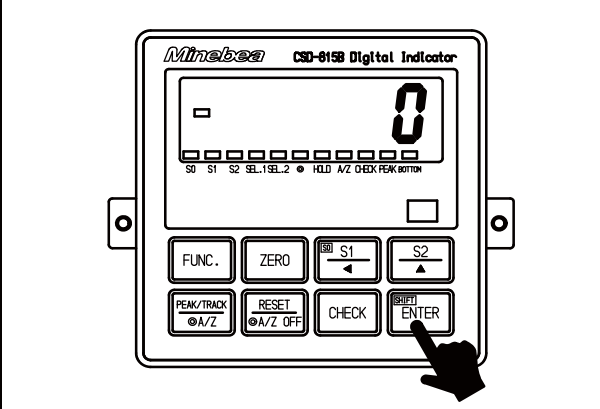
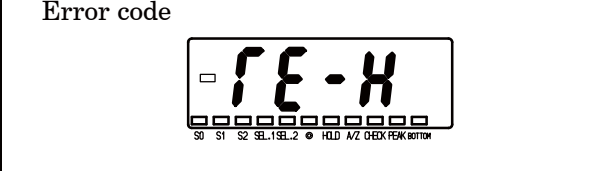
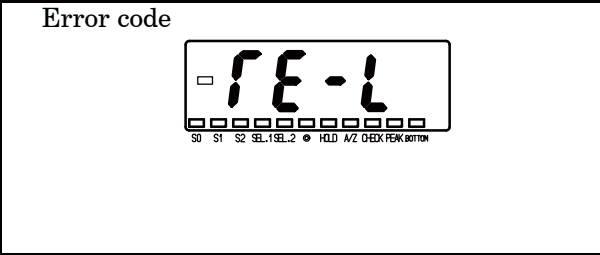

5-3. Selection of calibration methods on each condition

The instrument prepares calibration methods shown in the paragraph in 5-2. Calibration procedures, we will explain some conditions to execute actual calibration here.

(1) When executing calibration on the new instrument.

(In case that Combined Inspection at Minebea has not executed.)

- When load condition and output condition of load cell are clarified.
(Required accuracy is less than 1/1 000 or so.)
→ Proceed to the paragraph 5-3-1(1)
- When load condition and output condition of load cell are clarified.
(Required accuracy is more than 1/1 000 or so.)
→ Proceed to the paragraph 5-3-1(2)
- When load condition is clarified, but output condition of load cell is unclear.
→ Proceed to the paragraph 5-3-1(3)
- When exchanging with existing CSD-815B is required.
→ Proceed to the paragraph 5-3-1(4)

(2) When making calibration again.

- When calibration only for tare weight is required.
(In case that the combined Inspection at Minebea has already executed, and the calibration only for tare weight is required.)
- When fine adjustment on zero and span is required.

5-3-1. In case of executing the calibration on the instrument newly.

When the new instrument is purchased or reuse is desired with the new specific conditions, execute the calibration with whichever procedure as follows :

(1) When the load condition and the output condition of load cell are clarified.

(In case of desired accuracy is less than 1/1000 or so.)



Warning

- The calibration accuracy obtained in this procedure is less than 1/1 000 or so. When precise accuracy more than 1/1 000 is necessary, make calibration with actual load according to the paragraph 5-3-1 (2).

Besides, the accuracy described here is a combined accuracy of the instrument and the strain gage applied transducer connected.

If there may exist another factors of error such as mechanical elements and so on, it will become out of warranty, so care should be taken fully.

- The rated output value for load cell applicable by the calculation should be assumed as the value described on the “Inspection data” individually.

For example, we will show the calibration procedures as follows, that is, 3 points of load cells with 3 mV/V of rated output and 5 t of rated capacity.

Tare weight	1.5 t
Weighing capacity	5 t
Maximum display	5 000

- ① Calculate the output of load cell at maximum display from the above conditions. Check that the calculated value should be within the range from 0.4 mV/V to 3.1 mV/V. If the value is out of the range, calibration can't be executed.

(Output of load cell at maximum display)

$$= \frac{(\text{Rated output}) + (\text{Rated output}) + (\text{Rated output})}{\text{Number of load cells}} \times \frac{\text{Weighing capacity}}{(\text{No. of load cells}) \times (\text{Rated load})}$$

$$= \frac{3 \text{ mV/V} + 3 \text{ mV/V} + 3 \text{ mV/V}}{3 \text{ points}} \times \frac{5 \text{ t}}{3 \text{ points} \times 5 \text{ t}}$$

$$= 1 \text{ mV/V}$$

- ② After making the load cell to the initial load condition (tare weight), execute the calibration according to the paragraph 5-2-1. In this case, input "5000" in the step 6, and input "1.0000" in the step 8 individually.
- ③ If necessity requires, apply zero/span fine adjustment according the paragraph 5-2-4, and 5-2-5.
- (2) When the both conditions of load and the output of load cell are clarified.
(In case that required accuracy is more than 1/1 000 or so.)

 **Warning** ● The accuracy obtained through the procedures of this calibration consists from combined accuracy with the instrument and combined strain gage applied transducer, the accuracy of weight used during the calibration, error factors on mechanical and also error factors on calibration works, that is, the total accuracy of these. If high accuracy is required, full considerations should be made on each factor. If neglected, there will be a case that desired accuracy may not be obtained, so care should be taken fully.

When high accuracy is required, actual load calibration by using the weight and so on are required.

For example, we will show the calibration procedures in the following conditions, that is, 3 points of load cell with 3 mV/V of rated output and 5 t of rated capacity.

Tare weight	1.5 t
Weighing capacity	5 t
Maximum display	5 000

- ① 1. Calculate the output of load cell at the maximum display from the above conditions.
Check that the calculated value at this point is within the range from 0.4 mV/V to 3.1 mV/V.
If the value is out of the range, calibration cant' be executed.

(Output of load cell at maximum display)

$$\begin{aligned}
 &= \frac{(\text{Rated output}) + (\text{Rated output}) + (\text{Rated output})}{\text{Number of load cells}} \times \frac{\text{Weighing capacity}}{(\text{No. of load cells}) \times (\text{Rated load})} \\
 &= \frac{3 \text{ mV/V} + 3 \text{ mV/V} + 3 \text{ mV/V}}{3 \text{ points}} \times \frac{5 \text{ t}}{3 \text{ points} \times 5 \text{ t}} \\
 &= 1 \text{ mV/V}
 \end{aligned}$$

- ② After making the load cell to the initial load condition (tare weight), execute the calibration according to the paragraph 5-2-3. In this case, input "5000" in the step 6, and input the load value applied on the load cell in the step 8 individually.
- ③ If necessity requires, apply zero/span fine adjustment according the paragraph 5-2-4, and 5-2-5.
- (3) When the load condition is clarified but the output condition of load cell is not clarified.

In the case of using the existing load detecting section, and adopting the new digital indicator only, it is necessary to execute calibration after checking the output of load cell when its output is not clarified.

For example, followings are calibration procedures when weighing capacity is 5 t and the others are not clarified.

- ① Set the instrument in the monitor mode according to the paragraph 7-15. In this condition, the output level of load cell connecting with the instrument can be monitored up to approx. 3.100 0 with the unit of mV/V.
- ② After making the load cell section to the initial load condition (tare weight), record the display value on load display. This value is the output of load cell at the time of initial load condition.
- ③ Record the display value on load display after applying 5 t load on the load cell section. This value is the output of load cell with weighing capacity applied.
- ④ 4. From the load cell output at the time of initial load application recorded at ②, and load cell output recorded at ③ at the time of application of weighing capacity, output of load cell at the time of maximum display can be calculated according to the below formula.
Check that the calculated value is within the range from 0.4 mV/V to 3.1 mV/V. The calibration cannot be executed if the value is out of the range.
(Output of load cell at the time of maximum display)
=(Output of load cell at weighing capacity) – (Output of load cell at initial load application)
- ⑤ Quit the monitor mode of the instrument.
- ⑥ After making the load cell to the initial load condition (Tare weight), execute calibration according to the paragraph 5-2-1. In this case, the accuracy is less than 1/1 000 or so. At this moment, input each value, "5000" in the step 5 and another input is the value of "Output of load cell at the maximum display" calculated from the ④ in the step 8. If the accuracy more than of 1/1 000 or so is required, execute calibration according to the paragraph 5-2-3. And at the same time, input "5000" in the step 6 and also input "Load value going to apply on load cell" in the step 8 individually.

⑦ As necessity requires, make fine adjustment on Zero and Span according to the paragraph 5-2-4 and 5-2-5.

(4) When replacing the existing CSD-815B with a new one.

 **Warning** ● The accuracy in this procedure is less than 1/1 000 or so.

If higher accuracy is required, make calibration by using the actual load according to the paragraph 5-3-1(2).

Moreover, the accuracy described here is a combined accuracy with the instrument and strain gage applied transducer connected.

When another error factors may exist, such as constructional error factors or so, it will become out of warranty for accuracy, so care should be taken fully.

When the load at the section of load cell cannot make it with initial load application due to failure on the existing CSD-815B, execute calibration by referring to the procedures as below. However, in case that the initial load condition can be obtained, make calibration according to the procedures of (1) and (2).

- ① According to the paragraph 8-1, read out and write down the function F-90 "Increment value", the F-91 "Maximum display value", the F-93 "Zero calibration value", and the F-94 "Span calibration value" in the existing CSD-815B.
- ② According to the paragraph 4, replace the exiting CSD-815B with a normal instrument and make connections.
- ③ After turning ON the normal instrument, make calibration according to the paragraph 5-2-2. In case of this, input the "Increment value" recorded at ① in the step 3, the "Maximum display value" in the step 5 and the "Zero calibration value" in the step 7 and in the same way, input "Span calibration value" in the step 9.

5-3-2. When the calibration is executed again.

When purchasing a new instrument and the combined inspection has executed at Minebea, however, the tare weight has changed, or fine adjustment on zero and span are required, make calibration with whichever the following methods.

(1) Calculation on tare weight only

(When combined inspection has completed at Minebea and calibration on only tare weight is required.)

When the initial load (tare weight) has changed after completing the calibration, or when the combined inspection at Minebea has been made and the calibration only for the initial load(tare weight) is required after the installation, proceed the calibration in the following steps.

- ① After setting the initial load (tare weight) on load cell section, execute calibration according to the paragraph 5-2-6.
- (2) In case of executing fine adjustment on zero and span
Make adjustment according to the paragraph 5-2-4(Fine adjustment on zero), and 5-2-5 (Fine adjustment on span).



Warning

● The accuracy obtained through the calibration procedures consists from combined accuracy with the instrument and strain gage applied transducer, the accuracy of weight used during the calibration, error factors on mechanical and also error factors on calibration works, that is , total accuracy of these.

If high accuracy is required, full considerations should be made on each factor. If neglected, there will be a case that the desired accuracy shall not be obtained.

5-4.Setting the prohibition against calibration

After completing all of the calibration procedures, setting can be made to prohibit any more calibration again by setting the function(Related function F-97).

For details, refer to the paragraph 7-17.

5-5. Changeover of calibration data

This unit can memorize four kinds of calibration data, and can use by changeover them. That changeover is made by the external control input, or function F-81. The changeover method is selected by function F-80. (Related function : F-80 and F-81)

Default has selected "Calibration data changeover by function F-81".

(1) Calibration data changeover by external control input

When "Changeover by the external control input" is selected by function F-80, the changeover of calibration data is executed by combining the SEL.1 input and the SEL.2 input.

Calibration data No.	SEL.1	SEL.2
0	Open	Open
1	Short	Open
2	Open	Short
3	Short	Short

(2) Calibration data changeover by function F-81

When "Changeover by function (F-81)" is selected by function F-80, the changeover of the calibration data is executed by setting function F-81. Default has selected calibration data 0.

Calibration data No.	Setting of function F-81
0	00000
1	00001
2	00002
3	00003



Warning

- When the analog output is made against four kinds of calibration data, the function setting by "Display value at the minimum analog output"(F-21), "Display value at the maximum analog output" (F-22), or the execution of "Fine adjustment of Analog output" is executed on each calibration data. If neglected, the correct output may not be obtained.
- The set content displayed in the function mode is displayed against the calibration data which has been selected by "External control input" and "Function F-81".



- When you execute the calibration, please execute it after setting the calibration data by using the external control input or function F-81.
- SEL.1 and SEL.2 of the external control input signal are used combinedly with the input signal of "Comparator code" changeover. When the both setting of function F-80 is selected to the target of "External control input", "Calibration data" and "Comparator code" changeover at the same time.

6. Operation procedure

We will show the operating procedures with keys located on the front panel.



Warning ● Each key operation should be made after interrupting the measurement. If it is made during measurement, it may cause an unexpected malfunction.



● Key operation in Measurement mode can be effective by pressing it for about one second or so.

6-1. key

6-1-1. Operations in Measurement mode

The Function mode can be entered, and the “FUNC” is shown on the load display section. In this condition, setting on the Function or shifting to another modes can be available.

6-2. key

6-2-1. Operated in the Measurement mode

When the display value on load display section is within 10 % against the maximum display value, (Refer to the Chapter 5.), the “0” display will be shown compulsively due to the zero set function of this operation . As for details, refer to the paragraph 7-12.

6-2-2. Operation is made in another mode

(1) Calibration

In each procedure of calibration procedures, setting value can be initialized.

(2) Function mode

In function mode, function number and setting value for the function can be made “0” compulsively.

(3) Comparator setting

The set value can be made “0” compulsively, with the condition of possible to set for comparator set value.



6-3. key

6-3-1. Operated in the Measurement mode

(1) When operated in single.

At the same time the LED for S1 is flashing on and off, the Comparator S1 set value will display and the 10^0 digit will flash on and off, that makes the Comparator S1 set value possible to set. Also, if you keep the instrument untouched for approx. 20 seconds, the Measurement mode can be re-entered automatically. Pressing the  key makes to register the set values internally, then the condition of S1 set value possible to set” can be over.

(2) When operated with the key pressed.

At the same time the LED for S0 is flashing on and off, the Comparator S0 set value will display and the 10^0 digit will flash on and off with the  key pressed, then that makes to possible to set the Comparator S0 set value. Also, if you keep the instrument untouched for approx. 20 seconds, the Measurement mode can be re-entered automatically. Pressing the  key makes to register the set values internally, then the condition of “Possible to set S0 set value” can be over.

6-3-2. Operation is made in another mode

(1) Carrying up the set value.

By pressing the  key with the condition of displaying various kinds of set values, the flashing digits for set value will carry up from 10^0 , 10^1 , 10^2 , 10^3 to 10^4 in order.

(However, the range of carry differs depending on the number of digits of set values and yes/no of polarity sign.)

(2) Change of function and so on.

Executes change of various kinds of functions in Function mode, and also change of function during Check mode.

(3) Decrement at the time of fine adjustment.

When the  key is pressed at the time of making fine adjustment on ZERO, SPAN and analog output, the targeted value will decrease.



- In the operation method of the paragraph 6-3-2(3), when the key is pressed for more than about 1 second, each operation will be executed continuously at a constant interval without ON/OFF operation of the key.

6-4. key

6-4-1. When operated in the Measurement mode.

At the same time the LED for S2 is flashing on and off, the Comparator S2 set value will display and the 10^0 digit will flash on and off that makes to possible to set the set value for Comparator S2. And if you keep the instrument untouched for approx. 20 seconds, the Measurement mode can be re-entered automatically. Pressing the  key makes to register the set values internally, then the condition of “Possible to set value for S2” can be over.

6-4-2. When operated in another modes

(1) Increment of set value

By pressing the  key with the condition of displaying various kinds of set values, the set value will increase per one count from 0, 1, 2, 3, 4, 5, 6, 7, 8, 9 and 0 again in order.

(2) Increment at the time of fine adjustment

When the  key is pressed at the time of making fine adjustment on ZERO, SPAN and analog output, the targeted value will increase.



- In the operation method of the paragraph 6-4-2(2), when the key is pressed for more than about 1 second, each operation will be executed continuously at a constant interval without ON/OFF operation of the key.

6-5. key

6-5-1. When operated in the Measurement mode.

(1) When the peak function is selected (Lighting off the Status display “”).

Changeover the display of peak value/track value.

(2) When the A/Z function is selected (Lighting up the Status display “”).

At the same time the Tare weight cancellation (A/Z) works and the load display value become the net weight display value, the “A/Z” on the status display will light up and load display becomes “0”.

6-6. key

6-6-1. When operated in the Measurement mode

(1) When the peak function is selected (Lighting off the Status display “◎”).

Set the display ”0”, and reset the comparative value for peak.

(2) When the A/Z function is selected (Lighting up the Status display “◎”).

At the same time the Tare weight cancellation clear(A/Z OFF) works and the load display value become the gross weight display value, the “A/Z OFF” on the status display will light up.

6-6-2. When operated in another modes.

When the  key is pressed while entered in various kinds of modes, you can shift to the Measurement mode.

6-7. key

6-7-1. When operated in the Measurement mode.

At the same time the CHECK value ON and the “CHECK” on the status display will light up, the load value equal to the set value with the F-11 on the load display value will be added.

By pressing the key again, the CHECK value will be OFF and return to the condition as it was.

6-8. key

Pressing the  key makes to register the set values internally, then the condition of “Possible to set” will be over.

7. Function and operation

7-1. External control input signal and contact output signal

The instrument is available to the external control through various kinds of input signals.

7-1-1. Input signal for external control

Activates by shortening with COM.1 (Terminal No. 14).

Terminal No.	Name	Operation
8	ZERO	When the indicated value on load display is within 10 % against the maximum display value, zero set function will activate by the operation and make the display "0" compulsively. (Same key operation in the paragraph 6-2.) As for the operational details, refer to the paragraph 7-12.
9	HOLD	While inputting the signal, the target selected with Function F-10 among display, contact output, analog output and options will be frozen. As for the operational details, refer to the paragraph 7-9.
10	PEAK /TRACK /A/Z	Change of Track value and Peak hold value, or changeover the Bottom hold value or Peak/bottom hold value, and A/Z function is selected with the F-70, then the Tare weight cancellation can be executed. (A/Z ON) Open : track value Short : Peak hold, Bottom hold, Bottom hold, Peak bottom hold value
11	RESET /A/Z OFF	During the various kinds of peak hold operation, reset condition is made by short circuit, and A/Z function is selected with the F-70, then the Tare weight cancellation clear can be executed. (A/Z OFF)
12	SEL.1	Changeover of comparator code and calibration data by the combination of SEL.1 and SEL.2. (The target selected by the function F-80 is changed.)
13	SEL.2	
14	COM.1	The common for the input signal (Terminal No. 8 to 13)



- Operation of input signal will be executed after shortening for more than 50 ms approximately.
- The pulse input for the functions of A/Z, A/Z OFF and effective once with more than the pulse width 50 ms.
(5, 10 and 20 ms can be changeable for level and pulse width. Related function F-72.)
- During the input of HOLD signal, when ZERO signal (or the ZERO key on the front panel) is input, operation of ZERO will be executed at the same time of cancellation of HOLD signal.
- After inputting the HOLD signal in power-OFF condition, turn ON the power, then the “HOLD” will light on the load display section. The load value will be shown simultaneous with the cancellation of HOLD signal.
- The COM. 1 (terminal No. 14) and the COM.2 (terminal No. 21) are isolated.

7-1-2. Contact output signal

Terminal No.	Name	Operation
18	S0	Operated with whichever condition as follows by the setting F-33 and F-37. 1a contact a) ON when the load display is more than the maximum display value. Normal OFF. b) ON when both of contact outputs of S1 and S2 are OFF (open). c) Same operations with S1 and S2. d) At the time of PEAK ON or A/Z ON (By the setting F-7.) e) At the time of HOLD ON.
19	S1	The contact output for comparator S1. 1a contact.
20	S2	The contact output for comparator S2. 1a contact.
21	COM.2	The common for the contact output (terminal No.18 to terminal No.20).



- COM. 1 (terminal No.14) and COM.2 (terminal No.21) are isolated.
- The comparator in the instrument executes comparative operations synchronous with the display.
- The delay time starting from preparing the output conditions to the contact output ON, will be 5 ms approximately.

7-1-3. Equivalent circuit

(1) External control input section

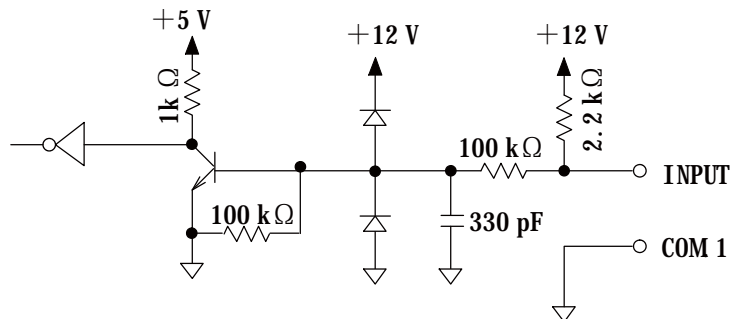

(2) Contact output section

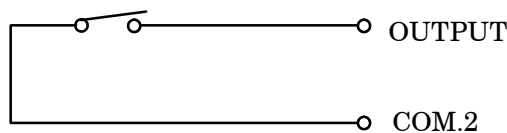

AC125 V 0.1 A (Resistance load)
DC30 V 0.5 A (Resistance load)

7-2.Comparator

The instrument prepares comparators that consist of 2 kinds of set values S1 and S2 and comparator S0 that can change the operation by the setting function F-33.



- The comparator of the instrument executes comparative operation synchronous with the display.

7-2-1. ON/OFF for the Comparator S0, S1 and S2.

Operational selection of ON/OFF can be made for each comparator S0, S1 and S2. These selection can be made with the function (Related function F-30).

As for default, all of the S0, S1 and S2 are selected ON.

7-2-2. Changeover of comparator code

The changeover is executed by the external control input or the function F-82. The selection of the changeover method is executed by function F-80.(Related function F-80 and F-82)

As for default, "Changeover of comparator by function(F-82)" is selected.

(1) Changeover of comparator code by the external control input.

When "Changeover by the external control input" is selected by function F-80, the changeover of the comparator code is executed by combining the input of SEL.1 and SEL.2.

Code No.	SEL.1 input	SEL.2 input
0	Open	Open
1	Short	Open
2	Open	Short
3	Short	Short

(2) Changeover of comparator code by function F-82

When "Changeover by function (F-82)" is selected by function F-80, the changeover of the comparator code by setting function F-82 is executed. As for default, code 0 is selected.

Code No.	Setting by function F-82
0	00000
1	00001
2	00002
3	00003



- When you change the comparator set value, change the comparator set value after adjusting the changing code by the external control input or setting by function F-82.
- SEL.1 and SEL.2 of external control input signal is used combinedly with the input signal of "Calibration data" changeover. When the all setting of function F-80 is selected to the target of "External control input", the changeover of "Calibration data" and "Comparator code" is made at the same time.

7-2-3. Change of set value





Warning ● When the set value for the comparator is set wrong, or set in the wrong procedures, it may not obtain the correct results from the comparator, and it may cause malfunctions in peripheral equipments and also cause a damage as well.

Procedures		
1	Selects the code which wants to set by external control input signal or function F-82.	
2	<p>Change of S0 set value</p> <p> To make effective for the S0 set value, set the F-33 as “00002=Normal comparator”.</p> <p>In the Measurement mode, pressing the key with the key pressed together, the 10⁰ digit on the front panel load display and the S0 on the judgement display will flash on and off, then change of S0 setting can be available.</p> <p>Every time the key is pressed, the flashing digit will change from 10⁰ digit→10¹ digit→10² digit→10³ digit→10⁴ digit→Polarity(POL)→10⁰ digit</p> <p>Change the set value by the key after flashing the digit which is desired to change.</p> <p> If you keep the instrument untouched for approx. 20 seconds in the condition of change of setting is available, the Measurement mode can be re-entered automatically.</p> <p>After fixing up the change, press the key. Make the set value effective, then the Measurement mode can be entered again.</p>	

Procedures

Change of S1 set value

In the Measurement mode, pressing the  key makes the 10⁰ digit on the front panel load display and the S1 on the judgement display will flash on and off, then change of S1 setting can be available.



Every time the  key is pressed, the flashing digit will change from 10⁰ digit→10¹ digit→10² digit→10³ digit→10⁴ digit→Polarity(POL)→10⁰ digit.

Change the set value by the  key after flashing the digit which is desired to change.

 If you keep the instrument untouched for approx. 20 seconds in the condition of change of setting is available, the Measurement mode can be re-entered automatically.

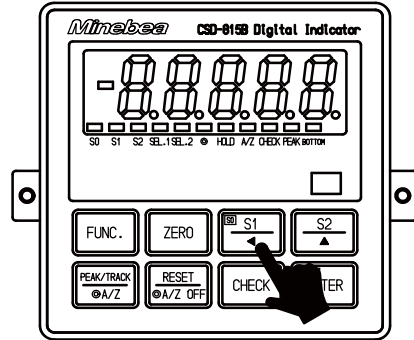
After fixing up the change, press the  key. Make the set value effective, then the Measurement mode can be entered again.





-  key : Set value carry key
-  key : Set value inclement key
-  key : Set value initialization key (Make the set value to "0".)

3

Change of S2 set value

In the Measurement mode, pressing the  key makes the 10⁰ digit on the front panel load display and the S2 on the judgement display flashing on and off, then change of S2 setting can be available.



Every time the  key is pressed, the flashing digit will change from 10⁰ digit→10¹ digit→10² digit→10³ digit→10⁴ digit→Polarity(POL)→

10⁰ digit. Change the set value by the  key after flashing the digit which is desired to change.

 If you keep the instrument untouched for approx. 20 seconds in the condition of change of setting is available, the Measurement mode can be re-entered automatically.

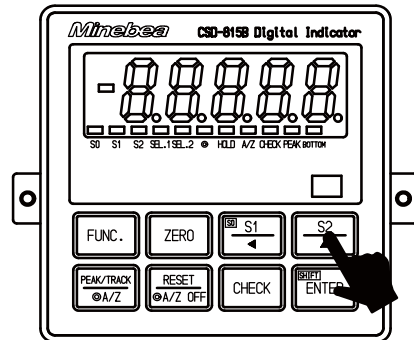
After fixing up the change, press the  key. Make the set value effective, then the Measurement mode can be entered again.



-  key : Set value carry key
-  key : Set value inclement key
-  key : Set value initialization key (Make the set value to "0".)

4

 **Warning** ● When you set the changeover of comparator code in the external control input, the input signal is always effective. So, be much careful to change in the measurement mode.

7-2-4. Operation on comparator S1, S2

The comparator in the instrument, S1 and S2 can select the operation whichever “contact ON at more than the set value”, or “contact ON at less than the set value”. This selection can be made in the Function mode. (Related function F-31)

As for default, the “contact ON at more than the set value” is selected for both of S1 and S2.



Warning ● Depending on the operational selection for comparator, ON/OFF condition for each contact output may differ. If wrong operation is selected, ON/OFF condition for contact output becomes inadequate and it may cause an unexpected accident due to malfunctions on peripheral instruments, so care should be taken fully.



● When the load display is “OL” or “-OL”, the “display value” for the comparison of comparator is assumed as “ $+\infty$ (infinity)” and “ $-\infty$ (infinity)” individually.

Operation on judgement display section and contact output will be shown as follows for the S1 as a sample.

(1) When the operation of “contact ON at more than the set value” is selected.

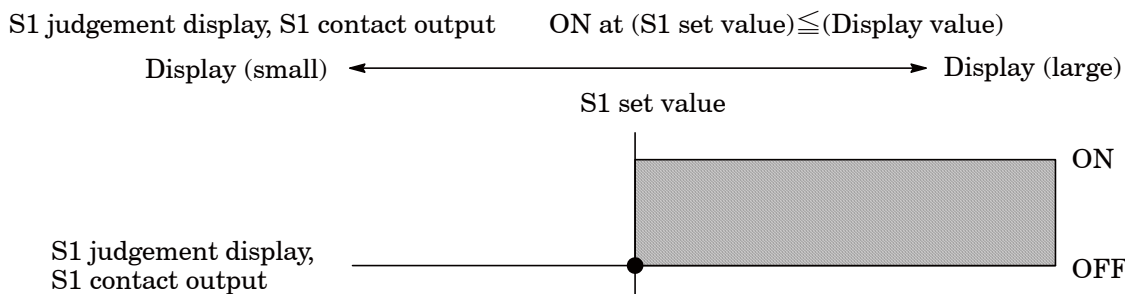

(2) When the operation of “contact ON at less than the set value” is selected.

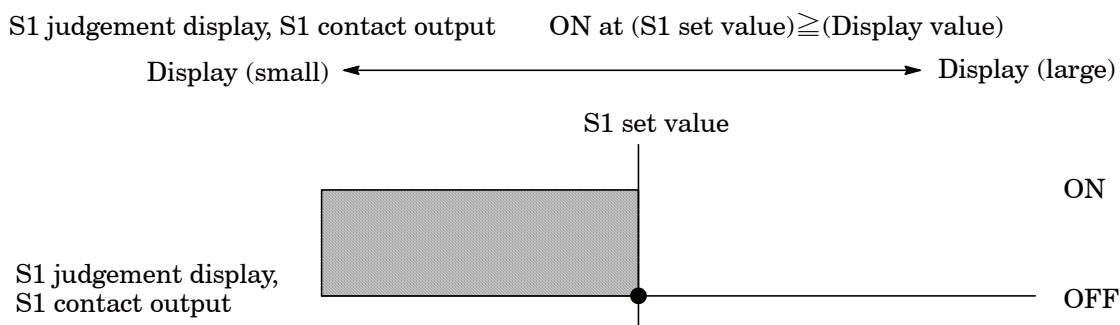

7-2-5. Comparative target for comparator S1, S2

The comparator in the instrument, S1, S2 individually can select the comparative target from the two, that is, “PEAK/Net weight”, “TRACK/Gross weight”. This selection can be made in the Function mode. (Related function FUNC-31) As for default, the “TRACK/Gross weight” is selected for both of S1 and S2.

 **Warning** ● Depending on the selection of comparative target for the comparator, ON/OFF condition for each contact output may differ. If wrong operation is selected, ON/OFF condition for contact output becomes inadequate and it may cause an unexpected accident due to malfunctions on peripheral instruments, so care should be taken fully.

Operation on judgement display section each comparative target and the operation of contact output will be shown as follows when the operation of “contact ON at more than the set value” is selected by S1, for an example. The same is the operation of S2.

(1) When the operation of “PEAK/Net weight” is selected.

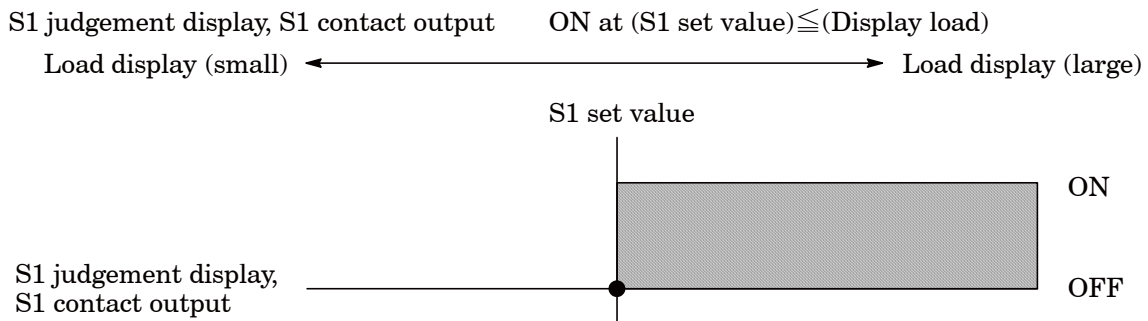

(2) When the “TRACK/Gross weight” is selected.

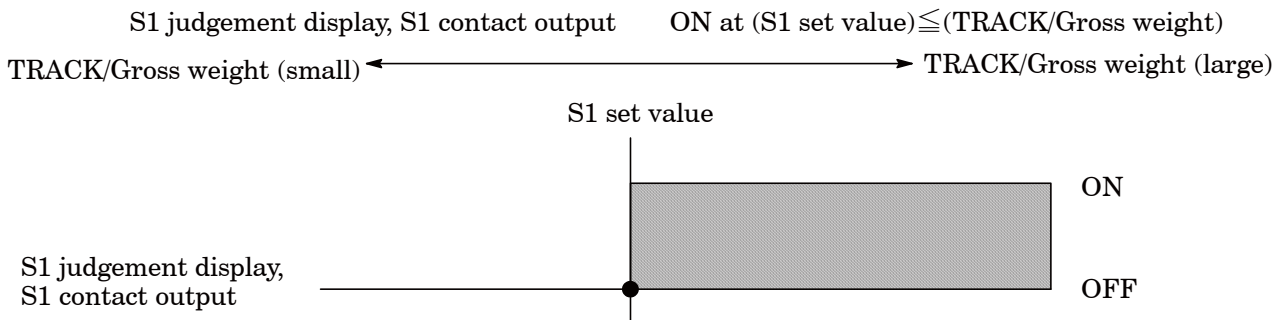

7-2-6. Operation of comparator S0

The comparator S0 in the instrument can select one among 4 operations from “00000” to “00003”. These selections can be made in the Function mode (Related function F-33, 37) As for default, the “0000” has selected.



Warning ● Depending on the selection of S0 operation, ON/OFF condition for each S0 contact output may differ. If wrong operation is selected, ON/OFF condition for S0 contact output becomes inadequate and it may cause an unexpected accident due to malfunctions on peripheral instruments, so care should be taken fully.

As example, the operation of S0 judgement display and S0 contact output at the time of whichever is selected from the “00000” to “00003” with the function F-33, are shown in the following table.

Setting F-33	Setting F-37	Operation
00000	—	ON when both of contact output S1 and S2 are OFF.
00001	—	ON when $(\text{load display}) \geq (\text{maximum Display value})$
00002	—	Operation of whichever “contact ON at more than the set value”, or “contact ON at less than the set value”.
00003	00000	ON at PEAK or A/Z ON
	00001	ON at the time of HOLD

In the next, as for the sample, the operation at S0 judgement display and S0 contact output selected “00000” with the Function F-35 will be shown as follows. The operation for S0 comparator when the “00002” is selected will be the same as the operation of S1 and S2 written in the paragraph 7-2-4, and 7-2-5.

(1) When the both of S1 and S2 select “more than” with the Function F-32.

S1 judgement display, S1 contact output	ON at $(\text{S1 set value}) \leq (\text{display value})$
S2 judgement display, S2 contact output	ON at $(\text{S2 set value}) \leq (\text{display value})$
S0 judgement display, S0 contact output	ON at $(\text{S1 set value}) > (\text{display value})$ and also $(\text{S2 set value}) > (\text{display value})$ at the same time

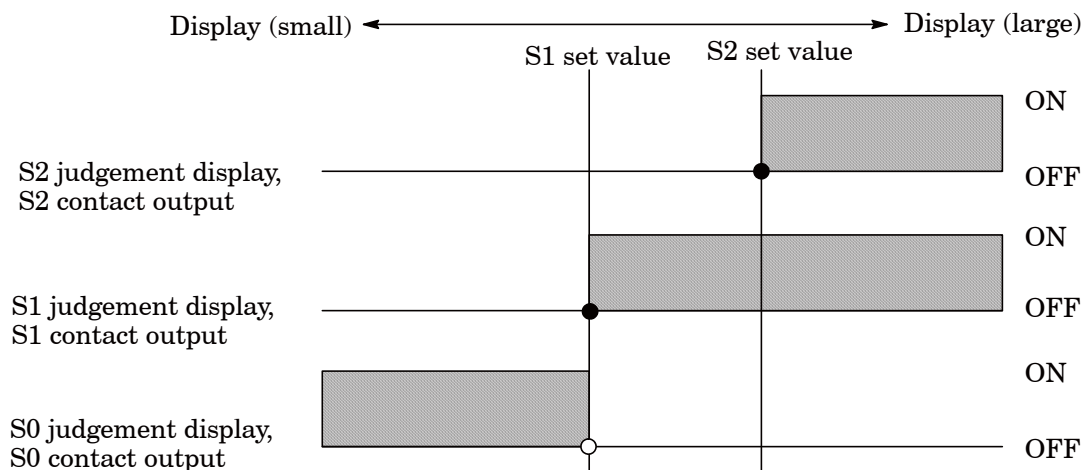

(2) When the S1 selects “less than” and the S2 selects “more than” with the Function F-32.

S1 judgement display, S1 contact output	ON at $(S1 \text{ set value}) \geq (\text{display value})$
S2 judgement display, S2 contact output	ON at $(S2 \text{ set value}) \leq (\text{display value})$
S0 judgement display, S0 contact output	ON at $(S1 \text{ set value}) < (\text{display value}) < (S2 \text{ set value})$

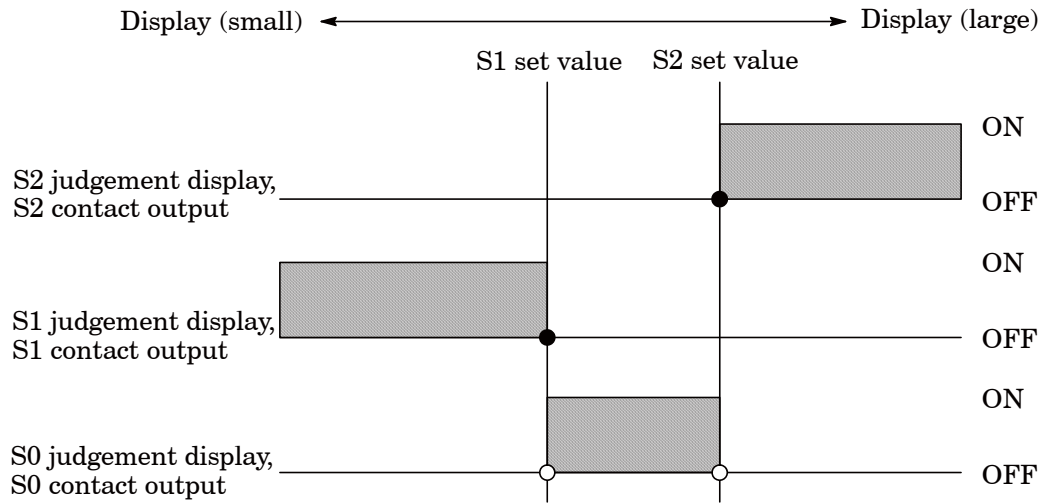

● Above figure indicates the case of $(S1 \text{ set value}) < (S2 \text{ set value})$.
 In the case of $(S1 \text{ set value}) \geq (S2 \text{ set value})$, the S0 judgement display and the S0 contact output will be normally OFF.

(3) When the S1 selects “more than”, and the S2 selects “less than” at the function F-32.

S1 judgement display, S1 contact output	ON at $(S1 \text{ set value}) \leq (\text{display value})$
S2 judgement display, S2 contact output	ON at $(S2 \text{ set value}) \geq (\text{display value})$
S0 judgement display, S0 contact output	Normally OFF

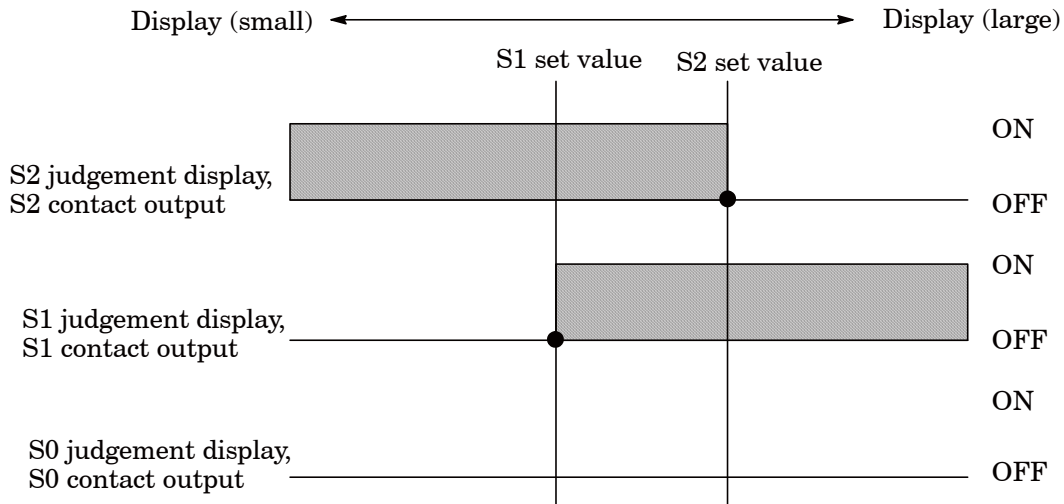

● Above figure indicates the case of $(S1 \text{ set value}) < (S2 \text{ set value})$.
 In the case of $(S1 \text{ set value}) \geq (S2 \text{ set value})$, the S0 judgement display and the S0 contact output will ON in the condition of $(S2 \text{ set value}) < (\text{display value}) < (S1 \text{ set value})$

(4) When both of the S1 and S2 select “less than” at the function F-32

S1 judgement display, S1 contact output ON at $(S1 \text{ set value}) \geq (\text{display value})$
 S2 judgement display, S2 contact output ON at $(S2 \text{ set value}) \geq (\text{display value})$
 S0 judgement display, S0 contact output ON at $(S1 \text{ set value}) < (\text{display value})$
 and also $(S2 \text{ set value}) < (\text{display value})$
 at the same time.

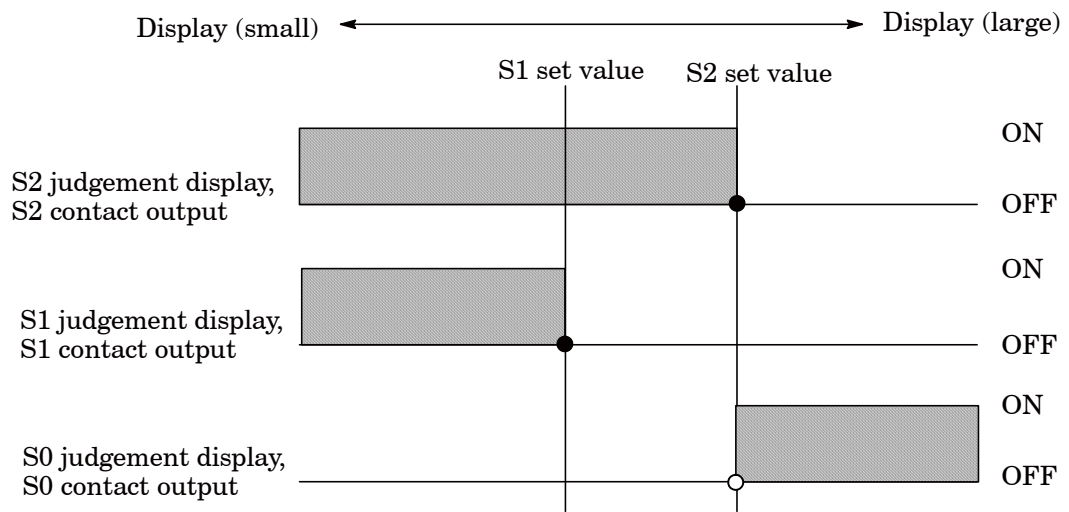

7-2-7. Hysteresis on comparator

The comparator S1 and S2 and normal mode for S0 (Function F-33: 00002 setting) can set hysteresis for prevention from chattering at output relay.

Hysteresis can be used by the combined setting of data width and time width. Moreover, effective direction for hysteresis can be selected from either “Off delay” or “On delay”.

These selections can be made in Function mode. (Related function F-34, F-35, F-36) As for default, hysteresis “OFF” is set.

 **Warning** ● Depending on the setting of comparator hysteresis, ON/OFF condition for each contact output may differ. If wrong mode is selected, ON/OFF condition for contact output becomes inadequate and it may cause an unexpected accident due to malfunctions on peripheral instruments, so care should be taken fully.

As for the example of S1, the operation of judgement display section and contact output when the hysteresis on comparator is set, will be shown as follows :

The same operation will be obtained in the case of “Normal mode” at S2 and S0.

- (1) When the operation of “contact ON at more than the set value” is selected at S1 and also effective direction for hysteresis is set as “On delay”.

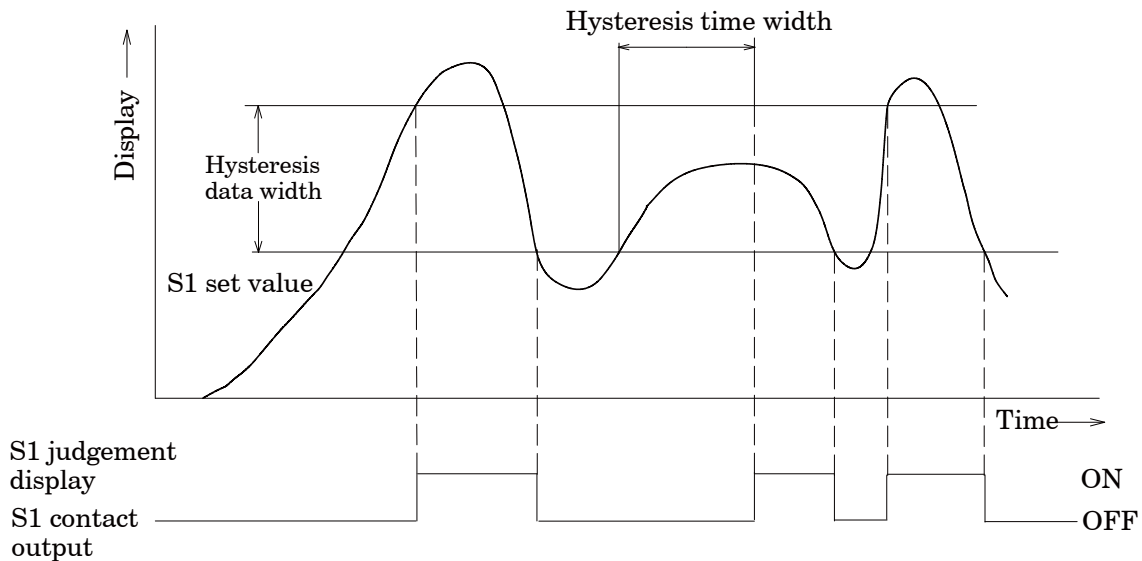

- (2) When the operation of “contact ON at more than the set value” is selected at S1 and also effective direction for hysteresis is set as “Off delay”.

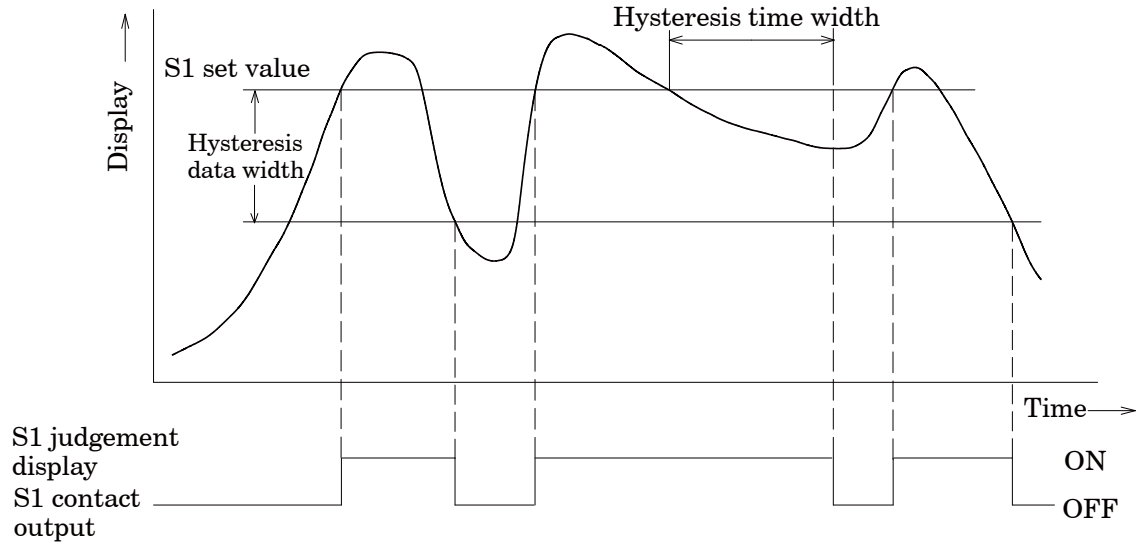

- (3) When the operation of “contact ON at less than the set value” is selected at S1 and also effective direction for hysteresis is set as “On delay”.

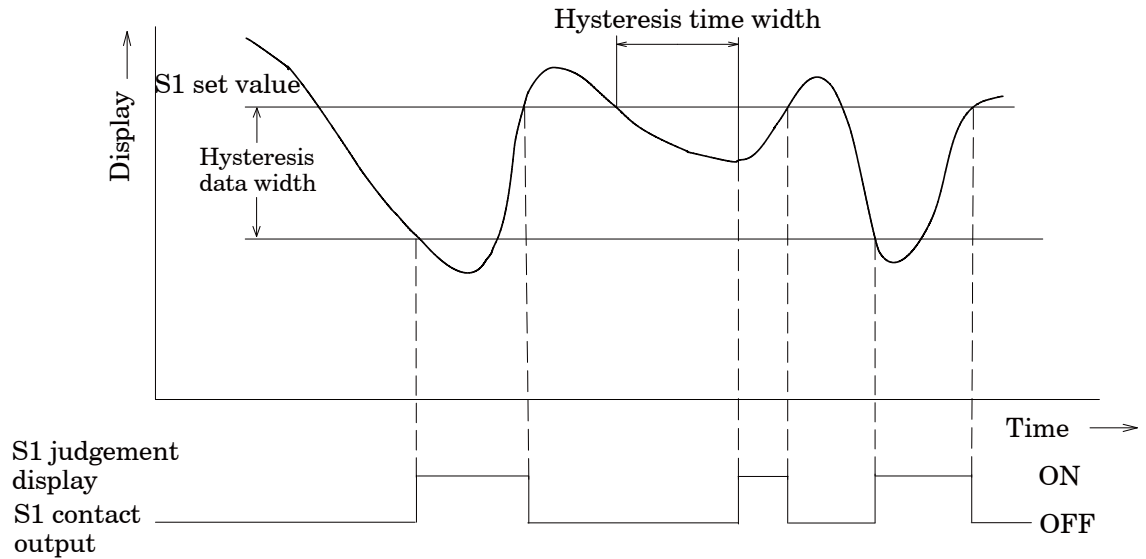

- (4) When the operation of “contact ON at less than the set value” is selected at S1 and also effective direction for hysteresis is set as “Off delay”.

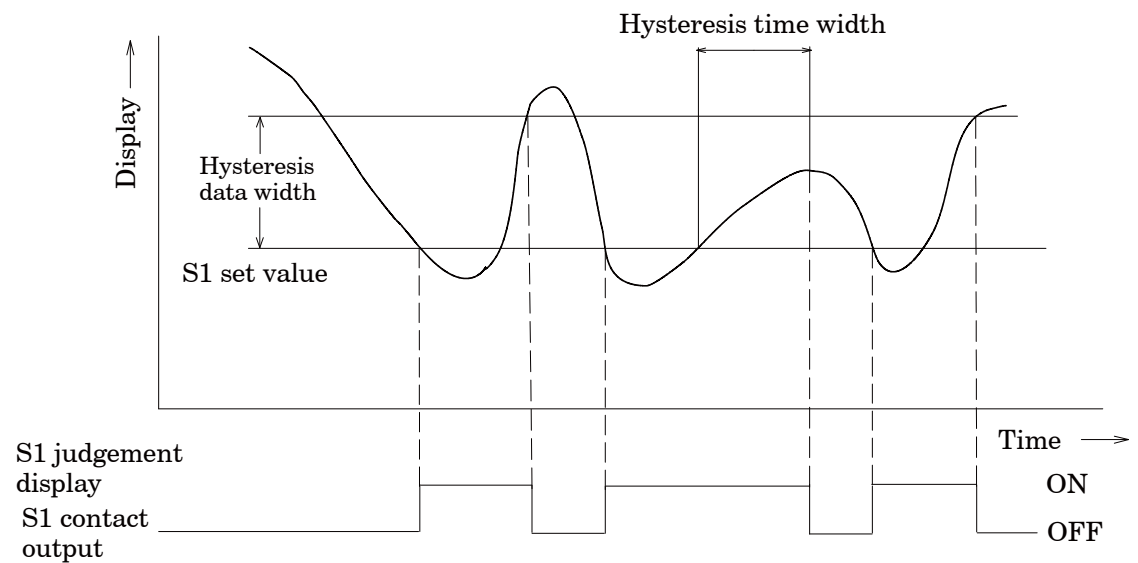

7-3.How to use the filter

The instrument prepares the analog filter consists of the low pass filter incorporated on the analog circuit, and the digital filter that stabilizes data converted into digital through calculation process.

 **Warning** ● When setting filter is not suitable, correct measurement can't be made and it may cause an unexpected accident, so care should be taken fully.

7-3-1. Analog filter

The instrument can change the pass band for the analog filter into 4 steps, such as 2 Hz, 10 Hz, 100 Hz and 2 kHz. (Related function F-05)

As for default, 2 Hz is selected.

The tendency of characteristics by the frequency are listed as below :

Averaged out times	2 Hz	10 Hz	100 Hz	2 kHz
Resist to noise	stable	←————→		rapid
Response speed	slow	←————→		quick

7-3-2. Digital filter

The digital filter for the instrument can be set from “00000” to “00008”.

The averaged-out times of digital filter can be decided from the set value (Related function F-04)

As for default, “00004” is selected.

The relations between the setting and the averaged-out times are as follows :

$$(\text{Averaged-out times}) = 2^n \quad n : \text{Set value}$$

For example, when “00004” is selected, averaged out times is as follows :

$$\begin{aligned} (\text{Averaged-out times}) &= 2^4 \\ &= 16(\text{Times}) \end{aligned}$$

The tendency of characteristics by the Averaged-out times are listed as below :

Averaged out times	low	high	
Resist to noise	rapid	←————→	stable
Response speed	quick	←————→	slow

7-4.Zero tracking

The instrument prepares the zero tracking in order to compensate for slow drift of zero.



- Effective only when the A/Z mode is selected. (Related function F-70)

7-4-1. What is zero tracking?

- Zero tracking is a function to cancel the slow drift of zero within the constant conditions, and also to follow the zero point of the instrument in order to stabilize zero point.
- When the data variation within the set time with function F-09 is within the set value set with the function F-08 against the zero point, then the input will be cancelled as the zero point. However, when the zero point compensation for the total “±10 % of the maximum display value” at the zero tracking and zero set are completed until that time, the further directional zero tracking will not executed.

7-4-2. Setting related with zero tracking.

- Set the data width that performs zero tracking with the function F-08. The zero tracking width per setting value “n” will be obtained by the calculation of display according to the below formula.

$$(\text{Zero tracking data width}) = (\text{Set value of F-08}) \times 0.5 \times (\text{Increment value for display})$$

For example, when the setting of function F-07 is “00010” and the increment value for display is “D=5”, then (Zero tracking data width) will be as follows:

$$\begin{aligned} (\text{Zero tracking data width}) &= 10 \times 0.5 \times 5 \\ &= 25D \end{aligned}$$

- Set the time width performs zero tracking with the function F-08.



- The zero tracking will not operate whichever the function F-09 or the function F-70 is set as “0”, or the function F-70 is “0”.

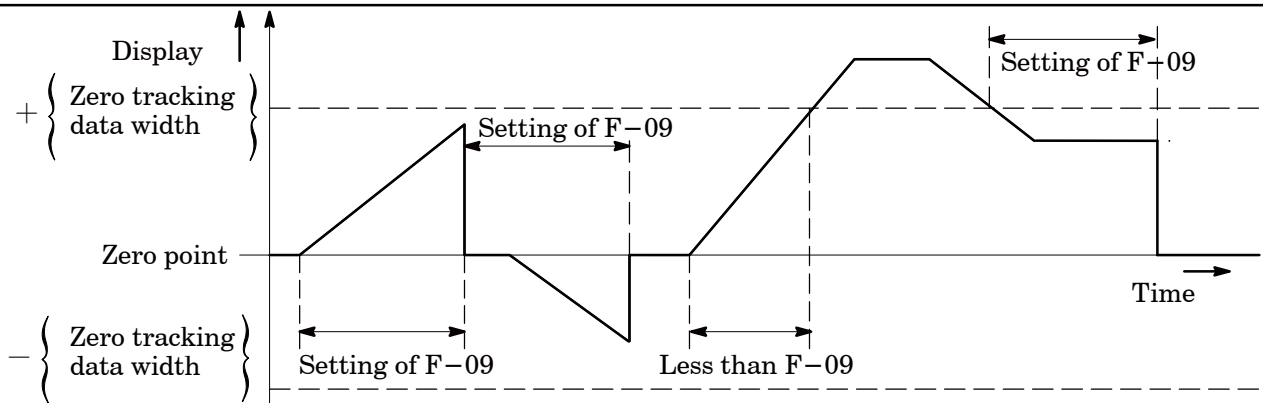



- When the load shows slow vibration in the vicinity of zero, never use the zero tracking.
- When the variation of load display becomes moderate due to the strength/weakness of the digital filter and stabilized filter, there may have the case that the zero tracking becomes effective even when the actual load variation is rapid, so care should be taken fully.

7-4-3. Cancellation for compensation by zero tracking

Cancellation for compensated data by zero tracking can be executed with the function F-98.



- When changing the target for zero tracking is required, be sure to cancel the compensated portion by zero tracking once using the function F-98.

The zero tracking of the instrument will become effective at the time of the load display will be the gross weight. In due course, at the time of A/Z ON, the zero tracking will not work.

7-5.Stabilized filter

The instrument prepares the Stabilized filter that can filter through digital filter strongly when variable width for load is within the constant value and also the same condition is frozen for more than a constant period.

7-5-1. What is the Stabilized filter?

When the variable width of load is within the set value by the function F-17 and also the same condition is frozen for more than the set value with the F-16, the digital filter for stabilized filter will become effective set with the function F-15. That is, the digital filter will be applied only when the load is stable for more than a constant value, and then stabilizes the load display.

7-5-2. Setting related with the Stabilized filter.

- Set the data to apply the Stabilized filter with the function F-17. The stabilized filter width per set value “n” can be obtained through the display conversion by using the following formula.

$$[\text{Stabilized filter data width}] = [\text{Set value of F-17}] \times [\text{Display increment value}]$$

For example, when the setting of function F-17 is “00010” and the display increment is “D=5”, then

$$\begin{aligned} [\text{Stabilized filter data width}] &= 10 \times 5 \\ &= 50 \end{aligned}$$

- Data width supervisory time for the Stabilized filter can be set with the function F-16.
- The digital filter for Stabilized filter can be set with the function F-15.
- The averaged-out times for the digital filter for Stabilized filter per set value “m” can be obtained by the following formula.

$$[\text{Stabilized filter averaged-out times}] = 2^m$$

For example, when the setting of function F-15 is “00006”,

$$\begin{aligned} [\text{Stabilized filter times}] &= 2^6 \\ &= 64(\text{Times}) \end{aligned}$$

- Moreover, when the digital filter has set with the function F-04, the averaged-out times will be “Stabilized filter averaged-out times” and “Averaged-out times” with the function F-04. (Refer to the paragraph 7-3.)

That is,

$$\begin{aligned} [\text{Averaged-out times}] &= [\text{Averaged-out times with the F-04}] \times [\text{Averaged-out times of stabilized filter}] \end{aligned}$$

For example, setting for the function F-04 is “00004” and the function F-15 is “00006”

as well, it will be as follows:

$$\begin{aligned} [\text{Averaged-out times}] &= 2^4 \times 2^6 \\ &= 16 \times 64 \\ &= 1\,024(\text{times}) \end{aligned}$$

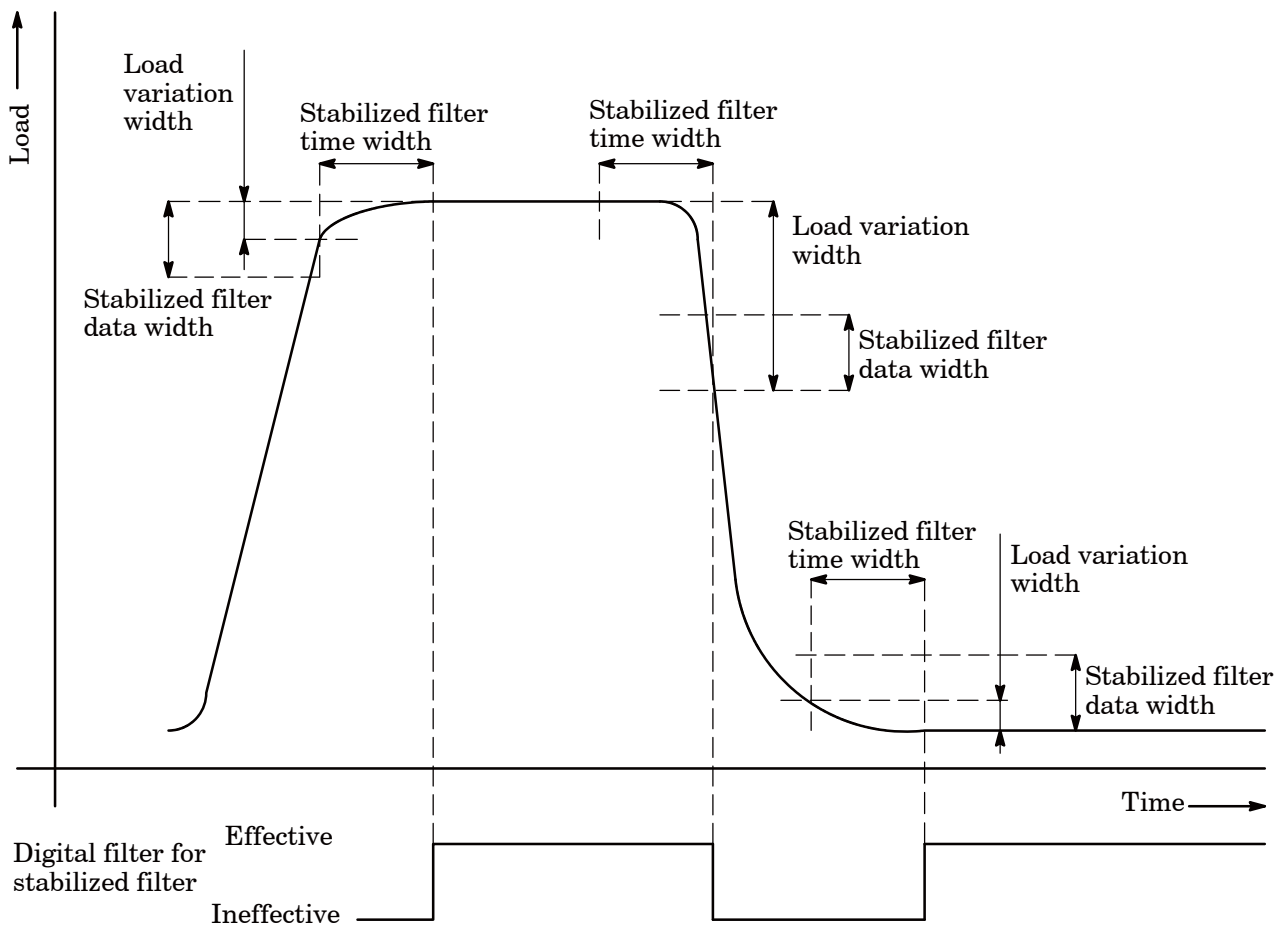

7-6. Change of Peak function and A/Z function

We can use the instrument by selecting one whichever the "peak function" or the "A/Z function". This selection can be performed in the Function mode. (Related function F-70.)

7-7. How to use various kinds of peak holds.

The instrument prepares 3 kinds of Peak hold functions, such as peak hold, bottom hold and peak bottom hold. These selections can be made in the function mode (Related function F-60 and F-61) And also there are 2 kinds, such as peak hold and digital hold.

7-7-1. Selection of the Analog peak hold and the Digital peak hold

The instrument prepares the “Analog peak hold” and the “Digital peak hold”.

By the “Analog peak hold”, the peak value of the signal corresponding to the response of analog filter (Related function F-05) can be obtained through the circuit of high speed analog peak hold (Related function F-61).

7-7-2. Peak hold

The maximum value for the load will be frozen.

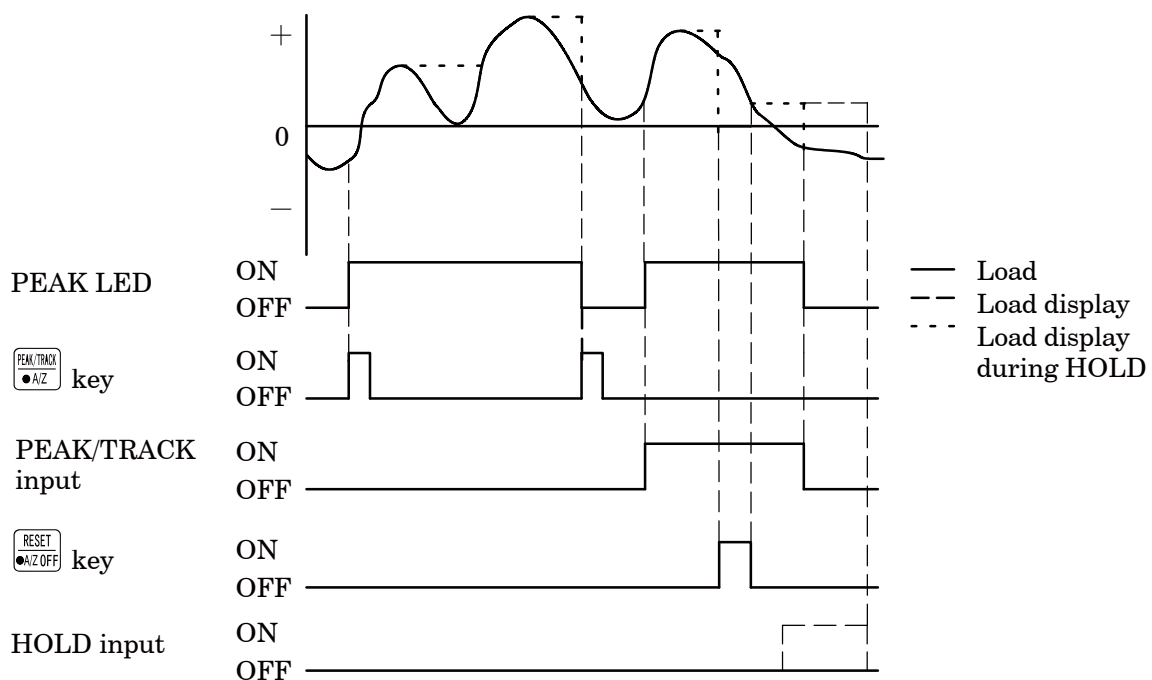

- At the time of short of PEAK/TRACK input, the peak hold condition will not change even if the  key is pressed ON.

7-7-3. Bottom hold

The minimum value for the load will be frozen.

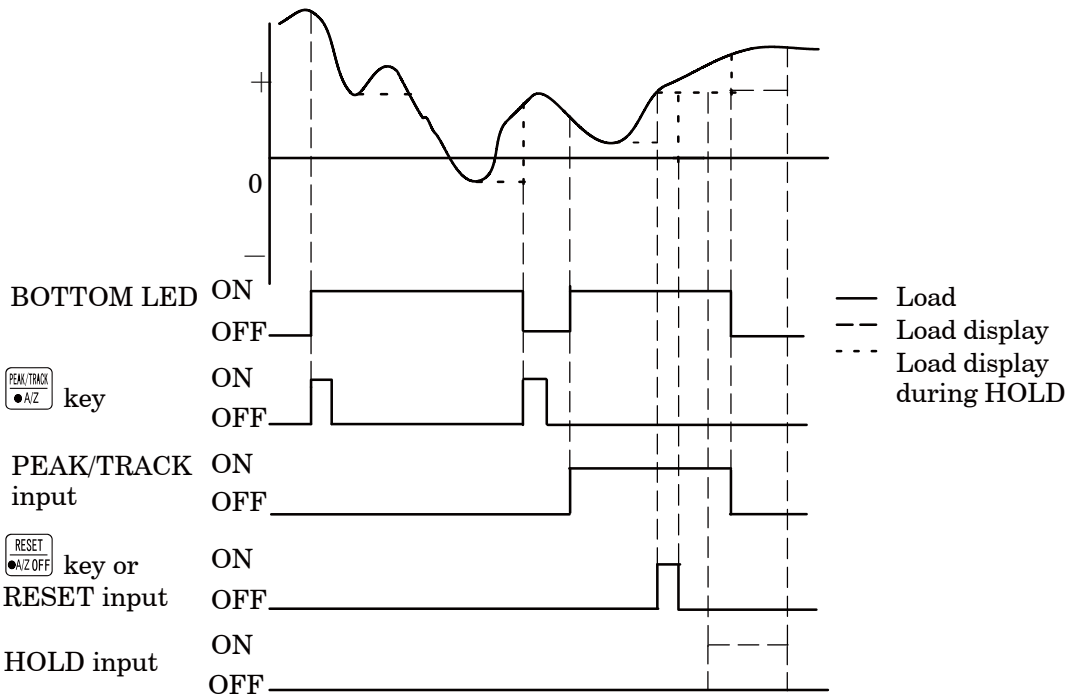

● At the time of input ON for PEAK/TRACK, the bottom hold condition will not change even if the key is pressed ON.

7-7-4. Peak bottom hold

The maximum value for the absolute value of load will be frozen.

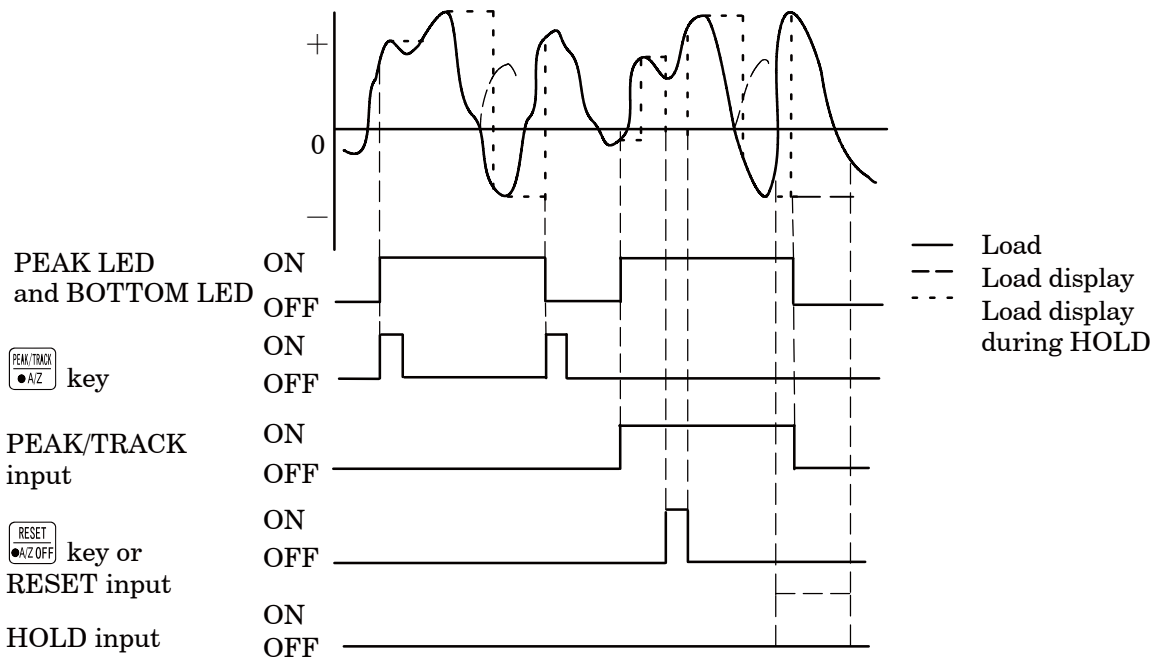

● At the time of input ON for PEAK/TRACK, the peak bottom hold condition will not change even if the key is pressed ON.

7-8. Various kinds of functions related with the display

7-8-1. Selection of target of display

The instrument can select the display times from the 4 times/s, 20 times/s 50 times/s and 100 times/s. This selection is available in the Function mode. (Related function F-03) As for the default, 4 times/s has selected.



- The comparator of the instrument executes comparative operation synchronous with the display. Besides, the conversion of analog output is synchronous with the display.
In due course, when changing of conversion times of comparator, and also conversion times of analog output is/are required, execute the change of display times with the function F-03.

7-8-2. Selection of position of decimal point display

The instrument can display the decimal point at the “Load display section” of the instrument. The selection of display can be made in the Function mode. (Related function F-01) As for the default, “No decimal point display” has selected.

7-8-3. Load display range

The load display range for the instrument is fixed from the -110% to 110% of the maximum display value at the time of setting during calibration. When less than the range, “-OL” displays and over the range “OL” displays. For example, when the maximum display value is “1 000”, the load display range will be from $-1\ 100$ to $1\ 100$.

Besides, when under $-1\ 100$, the “-OL” displays, and over $1\ 100$, the “OL” will display.

7-9. Selection the target for HOLD

The instrument can select the target for HOLD function among “load display”, “comparator S0 contact output, LED display”, “comparator S1, S2 contact output, LED display”, “Analog output” and “Options”.

This selection can be made in the Function mode (Related function F-10).

As for the default, “All is selected” is set. Allocation of setting for the F-10 are as follows :

10^0 digit : Load display

10^1 digit : Comparator S0 contact output, LED display

10^2 digit : Comparator S1, S2 contact output, LED display

10^3 digit : Analog output

10^4 digit : Optional output (BCD output, CC-Link load output, RS-232C load output, RS-422/485 load output)

※With the “0” setting, out of the target, and with “1” setting, target of HOLD.



- Even if “OL” error occurs while load display value is held, a load display section retains the holding condition.



- The LED display of S0, contact output of S0, and S0 of RS-232C, RS-422/485 and CC-Link interface are held while comparator S0 contact output is held.
- The LED display of S1 and S2, contact output of S1 and S2, and S1 and S2 of RS-232C, RS-422/485 and CC-Link interface are held while the comparator S1, S2 contact output is held.
- Even if the "OL" error occurs while analog output is held, the output data of an analog retains the holding condition.
- Even if the "OL" error occurs while optional output is held, the output data of BCD retains the holding condition.
- Even if the "OL" error occurs while optional output is held, the load value of CC-Link interface retains the holding condition.
"OL" error can be detected by an "Abnormal load value" signal.
- Even if the "OL" error occurs while optional output is held, the load value of RS-232C retains the holding condition.
- Even if the "OL" error occurs while optional output is held, the load value of RS-422/485 retains the holding condition.

7-10. Change of bridge power supply voltage

The instrument can select the bridge power supply from "5 V" and "2.5 V". This selection can be made in the Function mode (Related function F-12). As for the default, "5 V" has selected.



- When the bridge power supply voltage is changed, make calibration again.

7-11. Tare weight cancellation (A/Z)

The instrument prepares Tare weight cancellation (A/Z) function.

Pressing the  key makes Tare weight cancellation (A/Z) function operated and when the load display becomes net weight display, at the same time, the “A/Z” lights up on the status display and load display value becomes “0”.

Moreover, when the  key is pressed, Tare weight cancellation clear(A/Z OFF) function will activate and at the same time when the load display value becomes gross weight, the “A/Z” on the status display will put off.



- When tare weight cancellation (A/Z) function is required, select “00001 : A/Z function effective” by function F-70.
Upon this selection, “” on the status display will be light on, and A/Z function will be active.

7-12. Zero set

The instrument prepares zero set function.

When the display value on load display is within 10 % against the maximum display value (Refer to the chapter 5.), pressing the  key makes zero set function operated and the display will show “0” compulsively.

However, zero set will not be accepted when zero compensation for total $\pm 10\%$ is executed with zero set and zero tracking until that time. (ERR-0 display)

Also, the same operation can be made with the operation of “ZERO” at the input signal of external control. Cancellation for data applied zero compensation by zero set can be executed with Function F-98.



- When tare weight cancellation (A/Z) is executed (during A/Z display lights up), zero set will not be accepted. It will display “ER-5”.
When zero set is desired to execute, execute after making the Tare weight cancellation clear (A/Z OFF).



7-13.Key lock

The instrument prepares key lock function.

With the Function F-06, execute key lock OFF by setting each digit=0, and executes key lock ON by setting each digit=1. As for default, “all is key lock OFF”. Besides, the correspondence between the target of key lock and setting digits are as follows:





10⁰ digit : 

10¹ digit : 

10² digit : 、

10³ digit : 

10⁴ digit : 

Moreover, when the  key is locked, lock for the  key will be cancelled only once after the  key is pressed together with the  key for more than 3 seconds.

7-14.CHECK value

When the  key is pressed in the Measurement mode, CHECK value equivalent to the set value with the Function F-11 will be ON. And at the same time when the “CHECK” on status display lights up, the load value equivalent to the set value with Function F-11 will be added to the load display value. As for default, 0.3 mV/V has set.

By pressing the  key again, the CHECK value will be OFF and returns to the former condition as it is.



- When the setting of Function F-11 is “00000”, load display value will not vary even if the “CHECK” lights up on the status display by pressing the  key. (Because CHECK is 0.0 mV/V.)
- It is common to all of four kinds of calibration data and executed.



Warning

- When the power supply is turned on with shorting the external HOLD signal, the analog output will be made as follows:
When the target of HOLD by F-10 is the analog output, the analog output will become the minimum value.
- Be careful on the following point when CHECK switch is use.
The “OL” error display(Analog output at OVR.) will be displayed by setting the CHECK ON.
- Please execute function setting of “Indicated value with a minimum analog output” (F-21), “Indicated value with the maximum analog output” (F-22), “Fine adjustment of the analog output” of each calibration data when you use the analog output for four kinds of calibration data.
- The setting details displayed in the function mode is displayed to the calibration data has been selected by “External control input” and “Function F-81”.



- The analog outputs for the instrument are 2 type of “Voltage output” (Standard) and “Current output”(Optional).
- The analog output of the instrument executes re-writing the outputs synchronous with the display.
- The resolution of the analog output of the instrument is approx. 1/12 000 against the voltage output from -10 V to 10 V, and the current output from DC4 mA to 20 mA.
- The analog output has possibility of the output variation when the power is turned on. To take the stable condition, use the instrument about one hour after the power has been turned on.

7-15-1. Scaling of analog output

The analog output for standard specifications is set between the minimum value (the standard voltage output 0 V or the optional current output 4 mA) and the maximum value (the standard voltage output 10 V or the optional current output mA) with the output of 0 to 2 000.

By changing the F-21 and F-22, optional value can be decided.

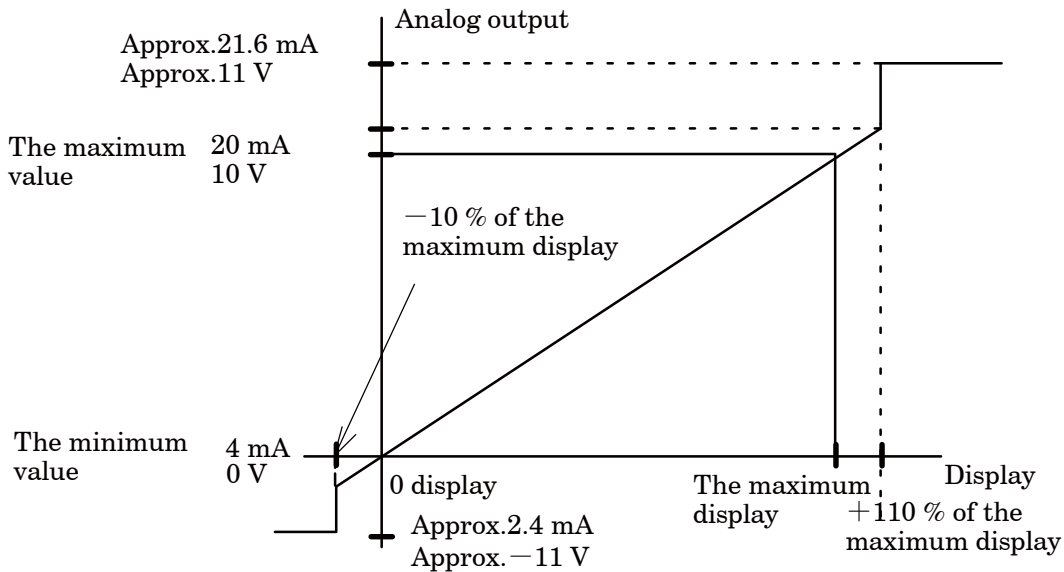

F-21 sets the display when the minimum value (the standard voltage output 0 V or the optional current output 4 mA) is desired to output.

F-22 sets the display when the maximum value (the standard voltage output 10 V or the optional current output mA) is desired to output.

例) F-21 : Set as 1 000

F-22 : Set as 5 000

When the display is 5 000, the maximum value outputs.

When the display is 1 000, the minimum value outputs.

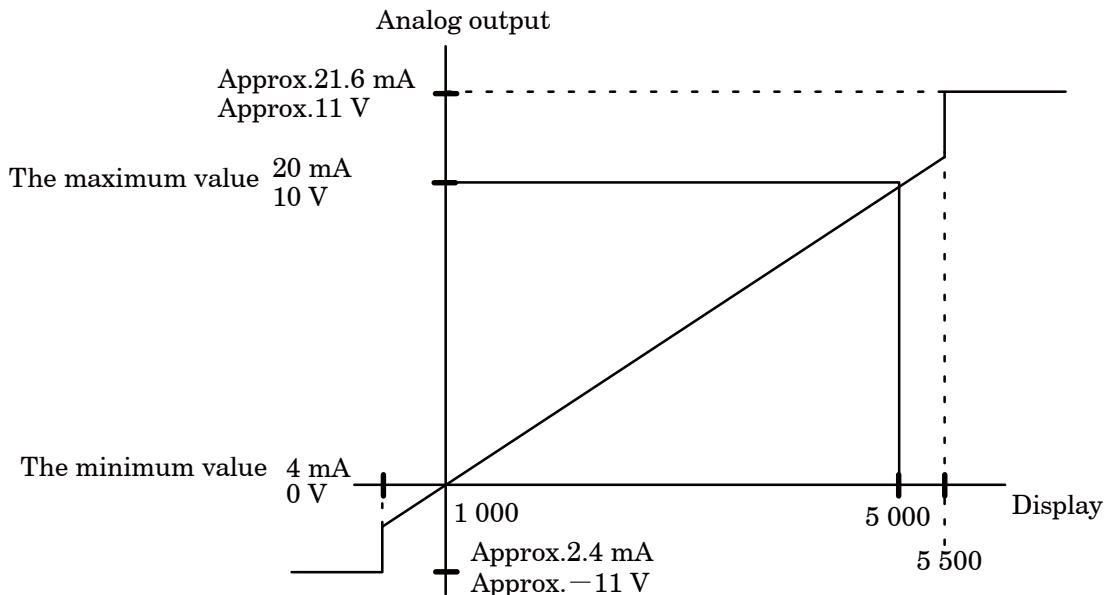



Warning ● Take care that the setting on the F-22 doesn't exceed the maximum display value that has set in the Chapter 5.





● For the F-21, less value than the value to set for F-22 should be set. If neglected, the correct output cannot be obtained.

7-15-2. Fine adjustment 1 on analog output

Fine adjustment described here, is the one to arrange each “the minimum value” and “the maximum value” without applying the actual load during the procedures. Refer to the paragraph 7-15-3, for the fine adjustment with actual load applied.

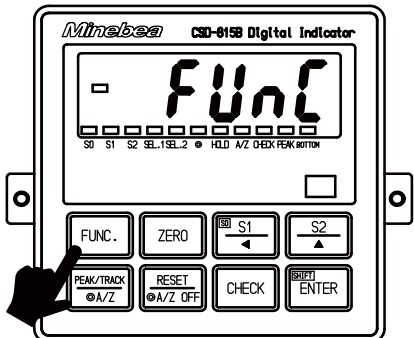

- During the application on fine adjustment, if you want to suspend, press the  key. The minimum value data, the maximum value data are kept as they were before entering the fine adjustment, and the Measurement mode can be re-entered.
- Make fine adjustment one (1) hour or so after feeding the power. You can make fine adjustment with safer conditions.

Procedures	
1	<p>Press the  key for about one second. The load display will show “FUNC”.</p> 

Procedures

2

Press the  key 9 times.
 The load display will change as “FUNC”
 →“CCAL”→“ACAL”→“LCAL”→“ZERO”
 →“SPAN”→“TARE”→“CHEK”→“MONT”
 →“VCAL”.

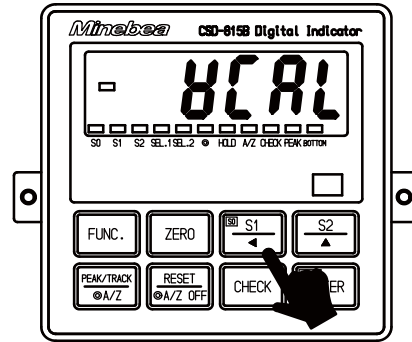

3

Press the  key.
 The load display will show “ALOW”.

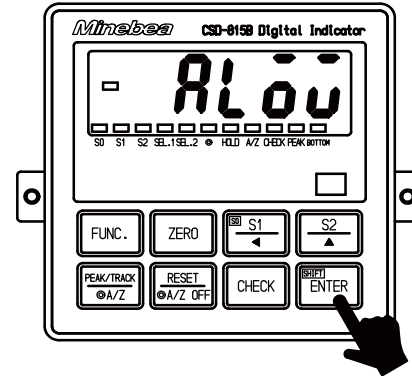

4

Press the  key.
 The load display will flash on and off showing
 “ALOW”.
 At the same time, the analog output equivalent
 to the minimum value of analog output will be
 obtained.
 Adjust so the output will become the minimum
 value with the right keys.

	Voltage output (Standard)	Current output (Optional)
Minimum value	0 V	4 mA



By pressing the key continuously,
 increment can be provided continuously

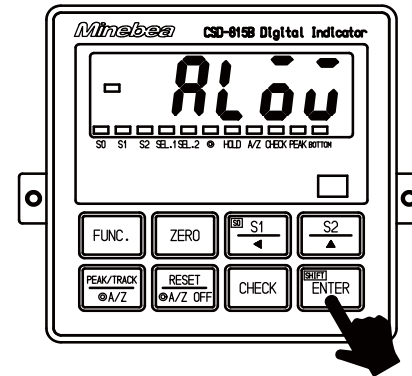

 key : Decrease the analog output

 key : Increase the analog output

5

Fine adjustment on the maximum value of
 analog output
 Press the  key.
 The load display will flashing display showing
 “A_HI”.

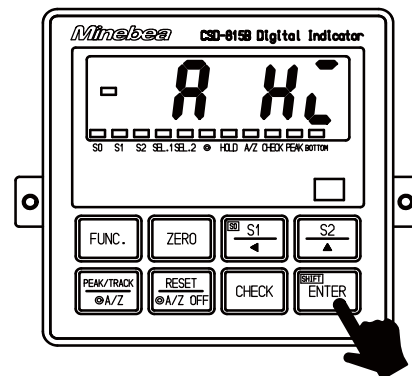

Procedures

6

Press the  key.
 The load display will flash on and off showing "A_HI".
 At the same time, the analog output equivalent to the maximum value of analog output will be obtained.
 Adjust so the output will become the maximum value with the right keys.

	Voltage output (Standard)	Current output (Optional)
Maximum value	10 V	20 mA



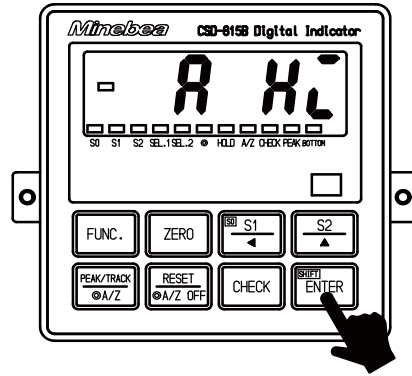

By pressing the key continuously, increment can be provided continuously



 key : Decrease the analog output

 key : Increase the analog output

7

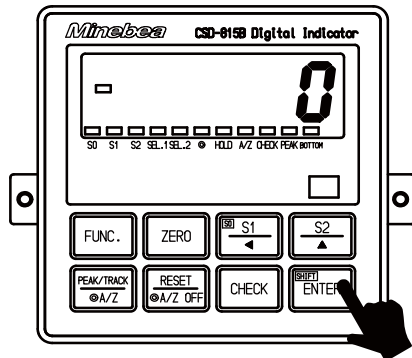
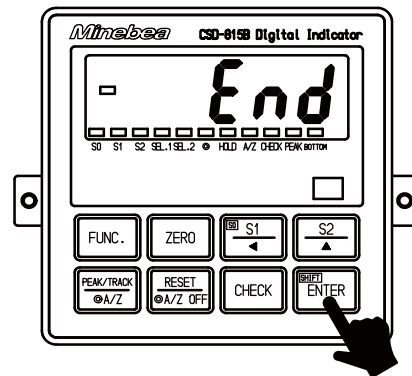

Press the  key.
 The load display will show "END".
 By pressing the  key again, the Measurement mode can be returned through the VCAL mode, then the present load will be shown.
 At this moment, the result of fine adjustment on the minimum/maximum output of analog output can be renewed.





7-15-3. Fine adjustment 2 on analog output





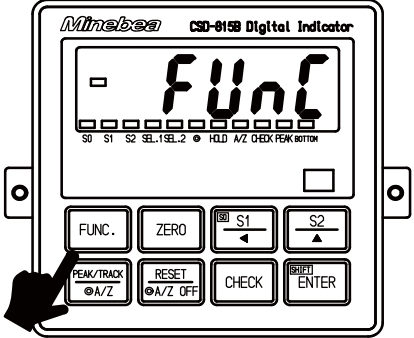

The fine adjustment explained in this paragraph is the procedures with applying the actual weight.

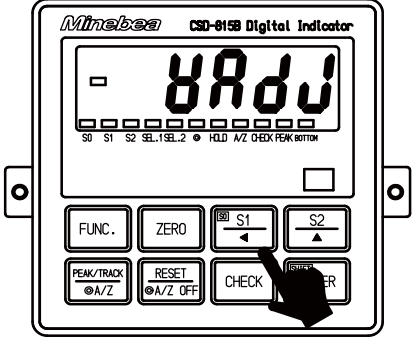
 **Warning** ● Before making the fine adjustment, be sure to make scaling for the analog output by referring to the paragraph 7-15-1. If neglected, deviation of output can't be adjusted during the fine adjustment.

 ● During the application on fine adjustment, if you want to suspend the fine adjustment, press the  key. The zero data, the span data are kept as they were before entering the fine adjustment, and the Measurement mode can be re-entered.

● Make fine adjustment in one (1) hour or so after feeding the power. You can make fine adjustment with safer conditions.

Procedures		
1	<p>Press the  key for one second. The load display will show "FUNC".</p>	
2	<p>Press the  key 10 times. The load display will change as "FUNC" → "CCAL" → "ACAL" → "LCAL" → "ZERO" → "SPAN" → "TARE" → "CHEK" → "MONT" → "VCAL" → "VADJ".</p>	

Procedures	
3	<p>Press the  key.</p> <p>The load display will show “ALOW”.</p> <p>At the same time, set the weight equivalent to the minimum output value of the analog output.</p>
4	<p>Press the  key.</p> <p>The load display will flash on and off showing the current load value.</p> <p>At the same time, adjust the deviation with the right keys so the analog output will meet with the actual weight.</p> <div data-bbox="236 770 839 878" style="border: 1px solid black; padding: 5px; margin-top: 10px;">  By pressing the key continuously, increment can be provided continuously. </div>
5	<p>Fine adjustment on the maximum value of analog output</p> <p>Press the  key.</p> <p>The load display will show “A_HI”.</p> <p>At the same time, set the weight equivalent to the maximum output value of the analog output.</p>
6	<p>Press the  key.</p> <p>The load display shows the current load value and flashes on and off.</p> <p>At the same time, adjust the deviation of analog output against the load with the right keys.</p> <div data-bbox="236 1671 839 1778" style="border: 1px solid black; padding: 5px; margin-top: 10px;">  By pressing the key continuously, increment can be provided continuously. </div>

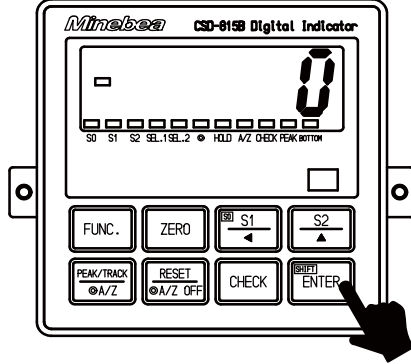
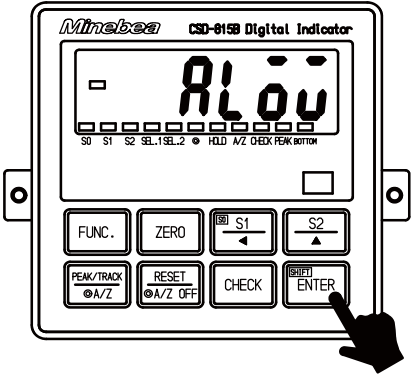

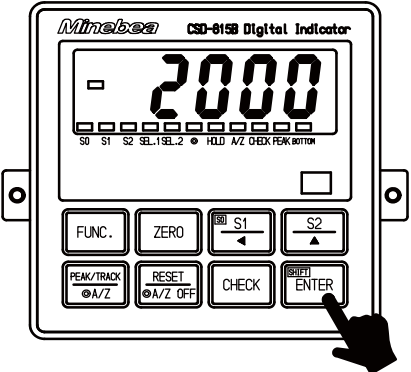
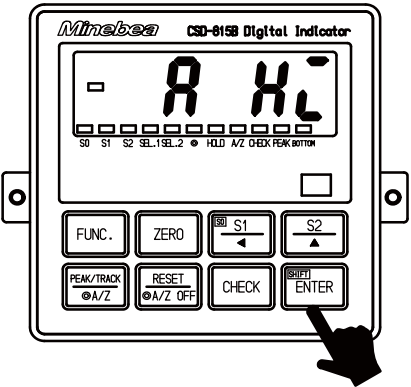

 key : Decrease the analog output

 key : Increase the analog output



 key : Decrease the analog output

 key : Increase the analog output

Procedures	
7	<p>Press the  key. The load display will show “END”.</p> <p>By pressing the  key again, the Measurement mode can be returned through the VADJ mode, then the present load will be shown. At this moment, the result of fine adjustment on the minimum/maximum output of analog output can be renewed.</p>

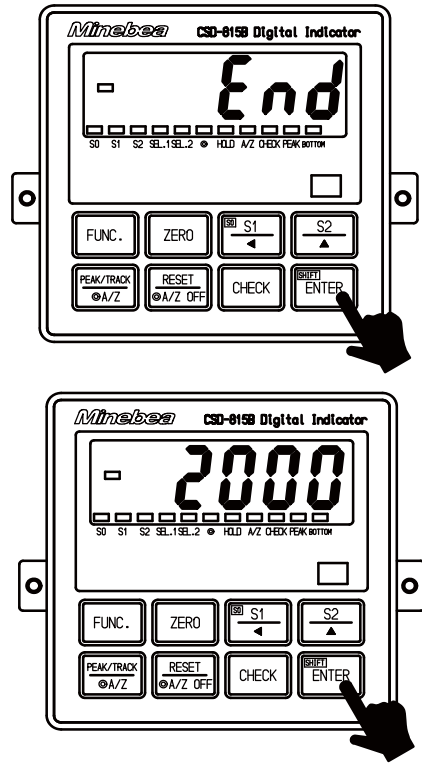

7-15-4. Selection of the target of analog output

The instrument can select the target of analog output from the “TRACK/gross load” and the “PEAK/Net weight”.

This selection can be made in the Function mode(Related function F-20).

Besides, during the “Gross/TRACK” is selected, the target of analog output will become normal “TRACK value” and normal “Gross weight” each, that is, at the time of selection of the “Peak function” with the Function F-70 and also the “A/Z function” is selected each.

7-16. Memory location for setting data and so on

The instrument can memorize each data at the RAM and the EEPROM as follows:

Since the EEPROM is non-volatile, it will be stored almost indefinitely.

Besides, the RAM is not a back-up type, so the RAM data will be disappeared by turning OFF the power supply.

① Data memorized at the RAM

- A/Z data Data clear is possible with the A/Z OFF
- ZERO tracking data Data clear is possible with the execution of F-98.

② Data stored at the EEPROM

- FUNC data Possible to initialize data with the execution of F-99
- Calibration data Possible to write by re-calibration
- Fine adjustment data for the analog output
 Possible to write by the fine adjustment again
- ZERO data Possible to clear the data with the execution of F-98
- Each set value for the comparator S0, S1 and S2
 Possible to clear with the change of each set value



- The memory locations for the A/Z data and the ZERO data can be changed to whichever the “RAM” or the “EEPROM” with the setting Function F-71.

7-17. Prohibition of calibration

The instrument prepares the setting for prohibition of calibration to prevent from excessive calibrations. This setting can be made in the Function mode.

(Related Function F-97.) As for the default, “Possible to calibrate” has selected. The targets of prohibition are each calibration described in the Chapter 5, and each fine adjustment on the analog output described in the paragraph 7-15-2 and the paragraph 7-15-3.

When executing the calibration with the setting of Prohibition of calibration, the “ER-6” will be displayed.

7-18. Check mode

The following confirmations can be made in the Check mode.



- Check on ROM version
- Check on the option installed.
- Check on bridge voltage
- Check on the external control input
- Check on the contact output
- Check on the analog output
- Check on the BCD output (option)



- The check on the BCD output will be operated only when the BCD output is installed.
- The instrument can return to the Measurement mode by pressing the  key even in the halfway of the Check mode.

7-18-1. Operating procedure for the check mode

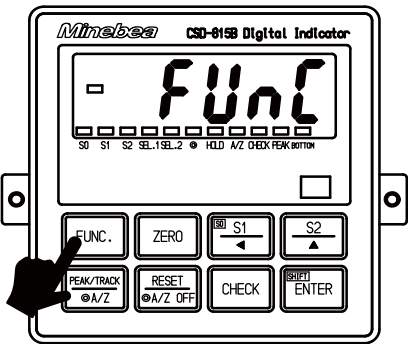

- When the  key is pressed with the load display of “FUNC”, the display will change as the following arrow marks indicate at every time the key is pressed. However, every time the  key is pressed, the display will change as the reverse direction of the following arrow marks.
 “FUNC”→“CCAL”→“ACAL”→“LCAL”→“ZERO”→“SPAN”
 →“TARE”→“CHEK”→“MONT”→“VCAL”→“VADJ”→“FUNC”
 →“CCAL” (Hereinafter over and over again.)

Procedures	
1	<p>Press the  key for one second. The load display will show “FUNC”.</p> 



Procedures

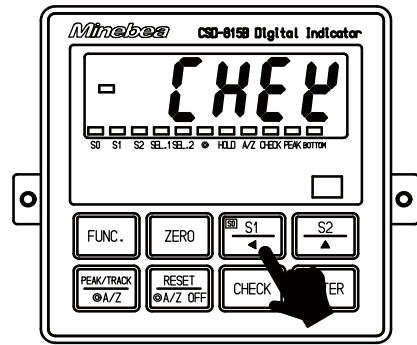

2

Press the  key 7 times.
 The load display will change as “FUNC”
 →“CCAL”→“ACAL”→“LCAL”→“ZERO”
 →“SPAN”→“TARE”→“CHEK”.



• Check on the ROM version

Press the  key.
 The Check mode can be entered, and the
 display on the load display section will show
 “ROM”. By pressing the  key again, the
 ROM version will be shown on the load display
 section.

 In the Check mode, when the display on
 the load display section will be the one in
 the below, the display can be changed by
 the  key operation.

3

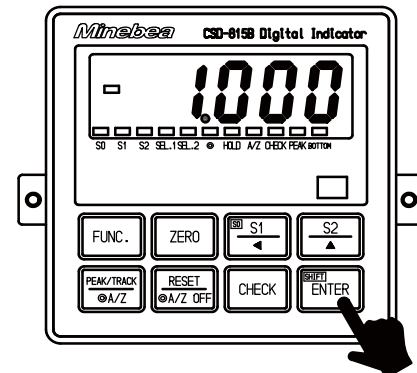
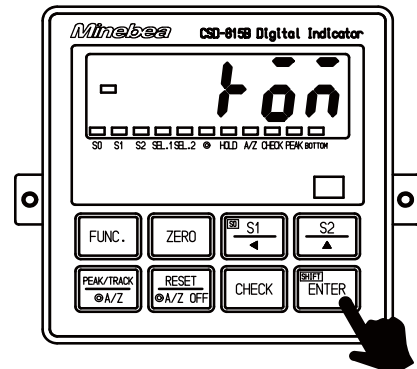
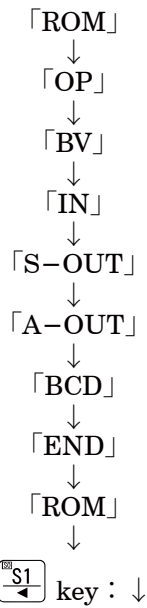

Procedures

4

- Check on the options

Press the  key.

The load display will show “OP”.

Check on bridge power supply voltage

By pressing the  key again, the load display will show the optional number of the option installed at present on the load display. When no option is installed, the “P-----” will be appeared.

Display	Installed options
07	Current output
15	BCD output
73	CC-Link interface
74	RS-232C interface
76	RS-422/485 interface

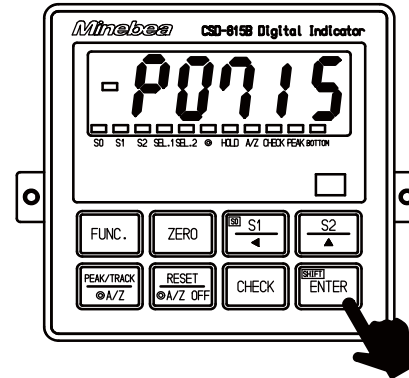
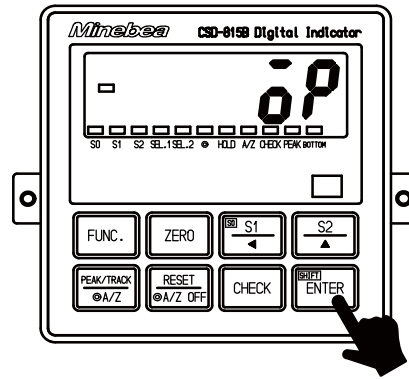

5









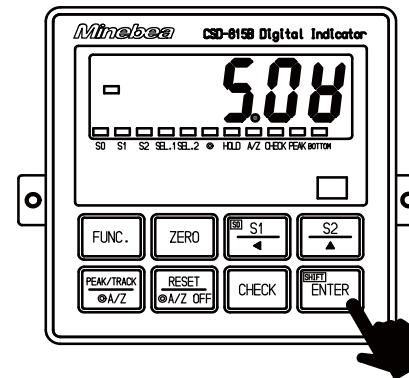
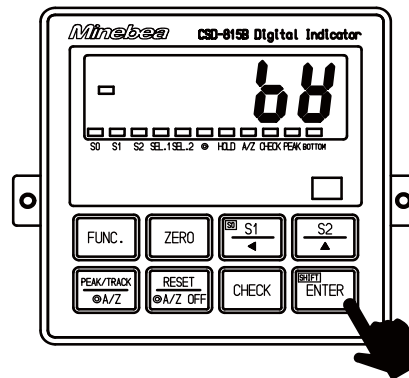

- Check on the bridge power supply voltage

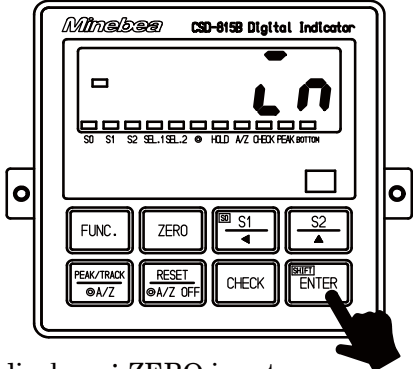
Press the  key.

The load display will show “bV”.

By pressing the  key again, the bridge power supply voltage selected at present will be seen on the load display section.

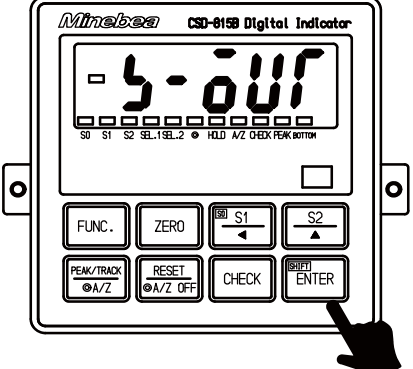
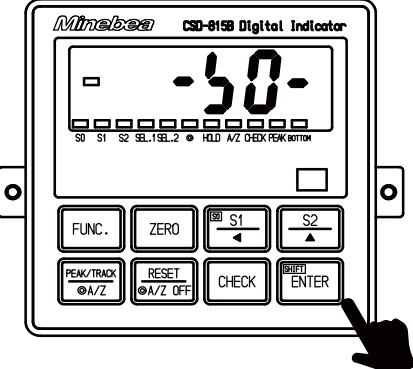



	Procedure	
6	<p>• Check on the external control input</p> <p>Press the  key. The load display will show “IN”.</p> <p>By pressing the  key again, the load display section will change into the “IN” flashing display.</p> <p>At the same time, the ON/OFF condition of external control input signal can be monitored on the Status display LED.</p>	 <p>A/Z display : ZERO input HOLD display : HOLD input PEAK display : PEAK/TRACK input ○ display : RESET input SEL.1 display : SEL.1 input SEL.2 display : SEL.2 input</p>
7	<p>• Check on the contact output</p> <p>Press the  key. The load display will show “S-OUT”.</p> <p>By pressing the  key again, the load display will flash “-S0-”.</p> <p>At the same time, by the operations of right keys, each judgement display for each contact output and the load display section will change as below:</p> <p style="text-align: center;">  ↓ ↑  ↓ ↑  </p>	  <p> key : Set ON the each contact output from the above to the below in order on the right figure.</p> <p> key : Set ON the each contact output from the below to the above in order on the right figure.</p> <p>S0 display : S0 output S1 display : S1 output S2 display : S2 output</p>

Procedures

• Check on the analog output

Press the  key.
The load display will show “A-OUT”.

By pressing the  key again, the display will show “LOW” and also flashes on and off.
At this moment the analog output will output the value equal to the “LOW” value shown in the below table.

Every time the  key is pressed, the display will change as the arrow marks indicate, and also the analog output will change as shown in the below table.

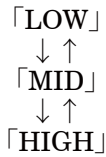

Display	Standard (Voltage output)	Option (Current output)
LOW	0 V	4 mA
MID	5 V	12 mA
HIGH	10 V	20 mA

 The output values here reflect the values adjusted in the paragraph 7-15-2, and 7-15-3.

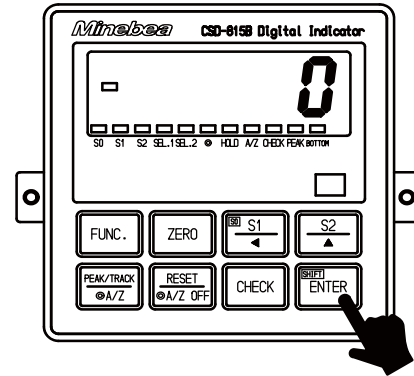
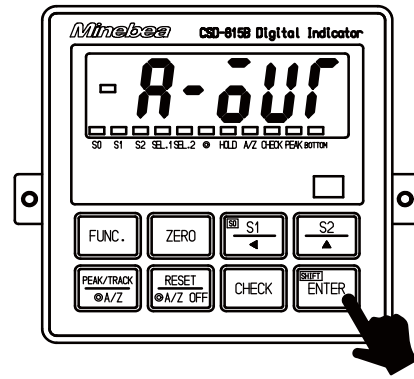



 key : Change the analog output from up to down in the left column.

 key : Change the analog output from down to up in the left column.

• Check on the BCD output

 In case that the BCD output isn't installed, shift to the step 10.

Press the  key.
The load display will show “BCD”.

By pressing the  key again, the display will show “00000” and the digit of 10⁰ flashes on and off.

At this moment, the same value as the display will output from the BCD output. When changing the display with the right keys, the BCD output will change corresponding to it.

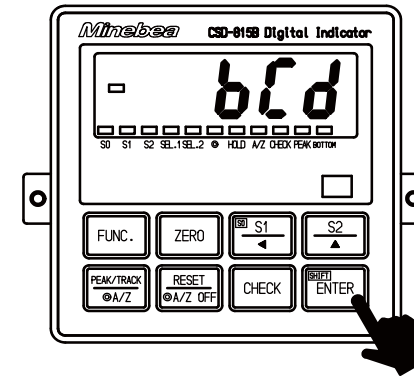

 key : Set value carry key

 key : Set value inclement key.

8

9

Procedures

Press the  key.
The load display will show “END”.

By pressing the  key again, it will over the
Check mode and returns to the Measurement
mode to show the load value.

10

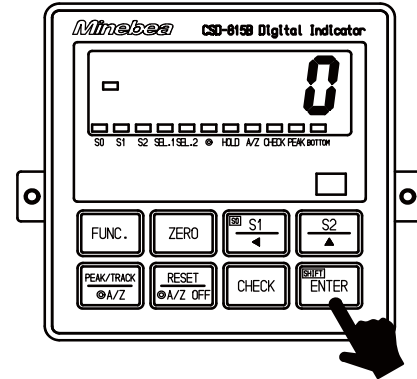
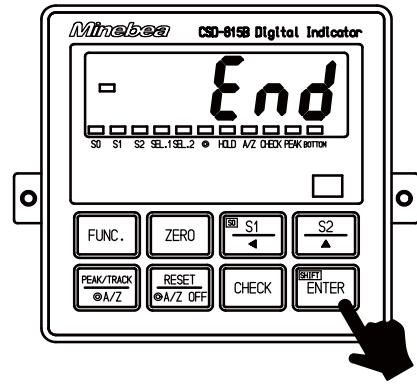





7-19. Monitor mode



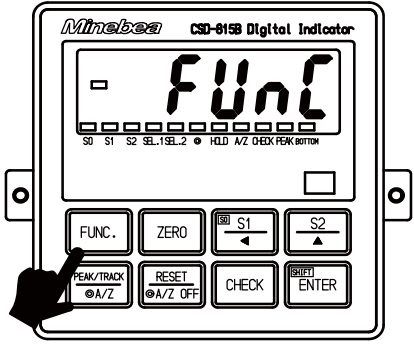

In the Monitor mode, the applied load on the strain gage applied transducer at present can be displayed with the converted unit of mV/V.

For example, in case that the load cell is used, and its output value is unclear, apply actual load in order to read the output value at the time of initial load application and also at the time of the maximum load application by using the function and then make calibration with the obtained value as a base.

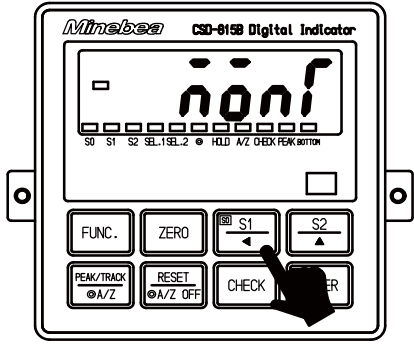

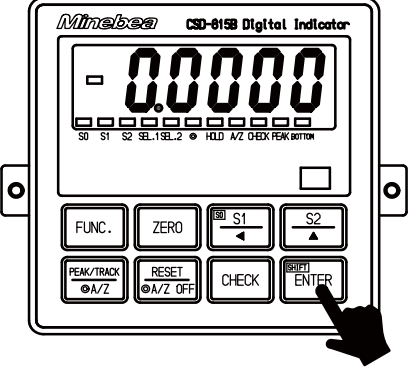

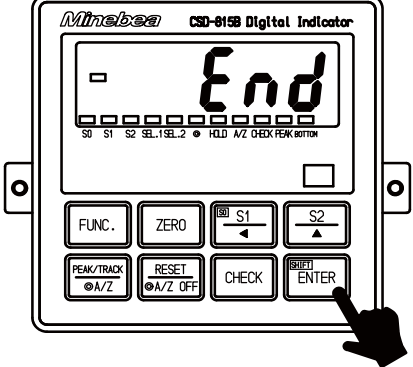
- The display value in the Monitor mode is a reference value.
The accuracy of display is 0.5 % approximately.
- In the Monitor mode, the range which can be monitored is from -3.1 mV/V to 3.1 mV/V approximately.
- When the  key is pressed with the load display of "FUNC", the display will change as the following arrow marks indicate at every time the key is pressed. However, every time the  is pressed, the display will change as the reverse direction of the following arrow marks.
"FUNC" → "CCAL" → "ACAL" → "LCAL" → "ZERO" → "SPAN" → "TARE" → "CHEK" → "MONT" → "VCAL" → "VADJ" → "FUNC" → "CCAL" ... (Hereinafter, over and over again.)

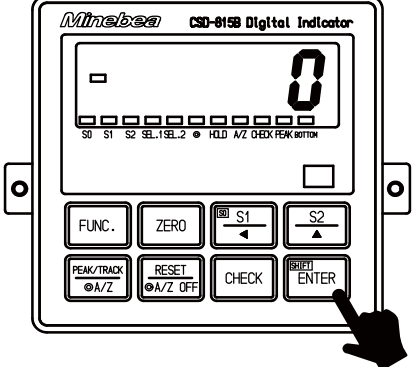
Procedures		
1	Press the  key for one second. The load display will show "FUNC".	
2	Press the  key 8 times. The load display will change as "CCAL" → "ACAL" → "LCAL" → "ZERO" → "SPAN" → "TARE" → "CHEK" → "MONT".	



	Procedure	
3	<p>Press the  key.</p> <p>The Monitor mode can be entered, and the converted value into mV/V for the present input value for the transducer will flash on and off on the load display.</p>	
4	<p>Press the  key.</p> <p>The load display will show "END".</p>	
5	<p>Press the  key.</p> <p>The Monitor mode can be over, and the present load is shown on the load display.</p>	







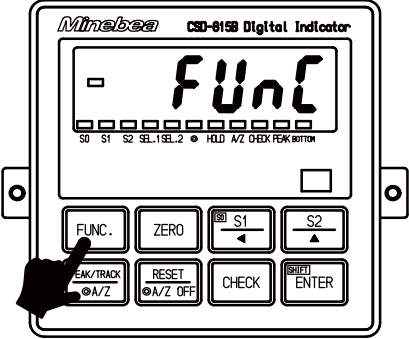

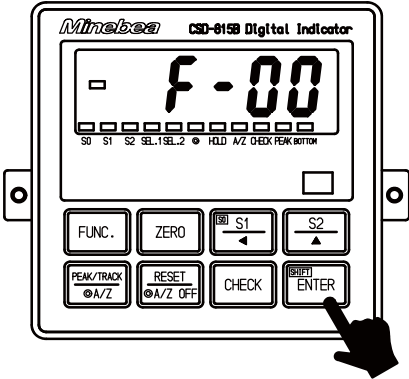



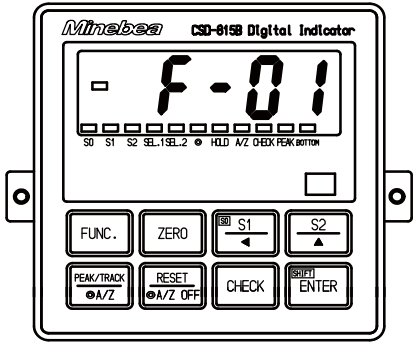

8. Function mode

 **Warning** ● During the Function mode, the instrument suspends measurement. In due course, even when input of strain gage applied transducer may change, various kinds of outputs will not change, which may cause destruction in equipment due to malfunction in peripheral equipments.

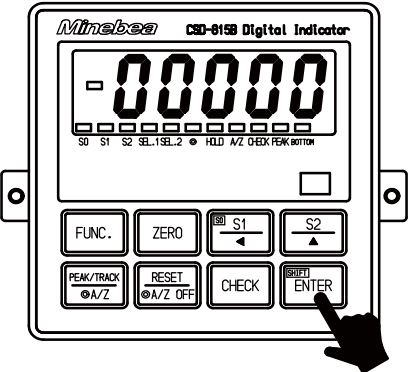
 ● When the display is treated as a target of HOLD (F-10), the Function mode can't be entered with the condition of inputting the HOLD signal. Before entering Function mode, be sure to cancel the input of HOLD.

8-1. Setting method for function mode

	Procedures	
1	Press the  key for about one second. The load display will show "FUNC".	
2	Press the  key. Function mode can be entered, then the load display will show "F-**", and the digit of 10^0 will flash on and off. The last called Function No. is shown at **. Suspend the setting of Function mode, then press the  key when returning to the Measurement mode is required.	

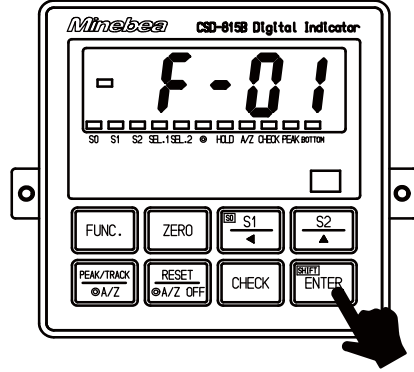
Procedures		
<p>3</p>	<p>Select the Function No. desired to set with the right keys. Suspend the setting of Function mode, then Measurement mode can be re-entered by pressing the  key.</p> <div style="border: 1px solid black; padding: 5px; margin-top: 10px;">  By pressing the key continuously, continuous increase will be provided. </div>	 <p> key : Set value carry key  key : Set value inclement key  key : Set value initialization key</p>
<p>4</p>	<p>Press the  key. Content of setting Function that has selected will be displayed and the digit of 10⁰ will flash on and off. Change the setting with the right keys. Press the  key to suspend the setting of Function mode, then return to the measurement mode.</p> <div style="border: 1px solid black; padding: 5px; margin-top: 10px;">  By pressing the key continuously, continuous increase will be provided. </div>	 <p> key : Set value carry key  key : Set value inclement key  key : Set value initialization key</p>
<p>5</p>	<p>Press the  key. The set contents are registered, then the load display will return to the registered Function No., and the 10⁰ digit will flash on and off. Press the  key. Setting another Function No. is desired, return to step 3.</p>	

Procedures

6

Press the  key.
Quitting the Function mode, the Measurement mode can be returned.

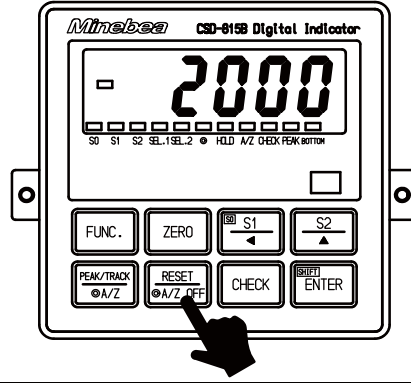

8-2. Function of Function data

- F-01 Selection of decimal point at display position

Initial value=00000 00000=Non
00001=10¹
00002=10²
00003=10³
00004=10⁴

※It is possible to set every calibration data which you selected.

- F-03 Selection of display rate

Initial value=00000 00000=4 times/s
00001=20 times/s
00002=50 times/s
00003=100 times/s

- F-04 Setting digital filter

Initial value=00004 Setting range : =00000 to 00008, Average of 2⁽ⁿ⁾ times









※Select the average times for digital filter. When the figure grows larger, the filter will become stronger, then effects from vibrations and so on are shown scarcely on the display. However, if too large figure is selected, the response to variation of input sensor will become worse.

※Using the digital filter where vibrations and so on may exist is effective for removing the deflection on the display.





- F-05 Setting analog filter

Initial value=00000 00000=2 Hz
00001=10 Hz
00002=100 Hz
00003=2 kHz

- F-06 Setting key lock

Initial value=00000 10⁰ digit :  key
10¹ digit :   key
10² digit :    key
10³ digit :  key
10⁴ digit :  key

※Key lock cancellation is made by setting “0”, and key lock is made by setting “1”.

Moreover, when the  key is locked, and the  key is cancelled only once immediately after by pressing the  key for more than 3 seconds with the  key pressed together.

- F-08 Setting zero tracking data width
 Initial value=00000 00000=Zero tracking OFF
 Setting range : 00000 to 00099
 Unit : 0.5D
 Data width of 49.5D with the setting “00099”.
 ※Effective only when the value of 00001to00099 is set with the F-07.
- F-09 Setting zero tracking time width
 Initial value=00020 00000=Zero tracking OFF
 Setting range : 00000 to 00099
 Unit : 0.1 s
 Time width of 9.9 s with the setting “00099”.
 ※Effective only when the value of 00001 to 00099 is set with the F-08.
- F-10 Setting of the target of HOLD
 Initial value=11111 10⁰ digit : Load display
 10¹ digit : Comparator S0 contact output, LED display
 10² digit : Comparator S1, S2 contact output, LED display
 10³ digit : Analog output
 10⁴ digit : Optional output
 ※Out of the target at the setting “0”, and the target of HOLD is available at the setting
 “1”.
- F-11 Setting the CHECK value
 Initial value=00003 Setting range : 00000 to 00015
 Unit : 0.1 mV/V
 Approx. 1.5 mV/V CHECK value at the setting “00015”.
- F-12 Setting bridge power supply voltage
 Initial value=00000 00000 : 5 V
 00001 : 2.5 V
 ※ It is common to all of four kinds of calibration data and executed.
- F-15 Setting digital filter for stabilized filter
 Initial value=00006 00000=Stabilized filter OFF
 Setting range : 00000 to 00008
 Average of 2^m times
 ※Selects average times of digital filter for stabilized filter.
 When the figure grows larger, the filter will be stronger, then the effects from
 vibrations and so on are scarcely shown on the display.
 ※Effective only when setting is made with the value from 00001 to 00099 with the
 F-16, and the value from 00001 to 00999 is set with the F-17.
- F-16 Setting time width for stabilized filter
 Initial value=00020 00000=Stabilized filter OFF
 Setting range : 00000 to 00999
 Unit : 0.01 s
 Time width of 9.99 s at the setting of “00999”.
 ※Effective only when the value from 00001 to 00008 with the F-15 and the value from
 00001 to 00999 with the F-97 are set.

- F-45 Setting the BCD P.C. width(Effective when the option is installed.)
 Initial value=00000 00000=125 ms
 00001=25 ms
 00002=10 ms
 00003=5 ms

- F-50 Setting the operation mode of RS-232C
 (Effective when the option is installed.)
 Initial value=00001 00000=Stream mode
 00001=Command mode
 ※In the Command mode, the data are transferred from the host by the command.
 In the Stream mode, the latest data is output continuously.

- F-51 Setting the target of output at the time of stream mode of RS-232C
 (Effective when the option is installed.)
 Initial value=00000 00000=TRACK/Gross weight
 00001=PEAK/Net weight
 ※In the Command mode, the data are transferred from the host to the command.
 In the Stream mode, the latest data will be output continuously.

- F-52 Setting the baud rate of RS-232C/422/485
 (Effective when the option is installed.)
 Initial value=00003 00000=1 200 bps
 00001=2 400 bps
 00002=4 800 bps
 00003=9 600 bps
 00004=19 200 bps
 00005=38 400 bps

- F-53 Setting the data bit length and parity of RS-232C/422/485
 (Effective when the option is installed.)
 Initial value=00021 10⁰ digit : Setting data bit length
 0=8 bit
 1=7 bit
 10¹ digit : Setting parity
 0=No parity
 1=Even number parity
 2=Odd number parity

- F-54 Setting the stop bit of RS-232C/422/485
 (Effective when the option is installed.)
 Initial value=00000 00000 : 1 bit
 00001 : 2 bit

- F-55 Setting the terminator of RS-232C/422/485
 (Effective when the option is installed.)
 Initial value=00001 00000 : CR
 00001 : CR+LF

- F-81 Setting of the calibration data selection
 Initial value=00000 00000 : Calibration data 0
 00001 : Calibration data 1
 00002 : Calibration data 2
 00003 : Calibration data 3
- F-82 Setting of the comparator code selection
 Initial value=00000 00000 : Code 0
 00001 : Code 1
 00002 : Code 2
 00003 : Code 3
- F-84 Setting the occupied station number of CC-LINK
 (Effective when the option is installed)
 Initial value=00002 00000 : 1 station
 00001 : 2 stations
 00002 : 4 stations



- Change the setting of the occupied station number is corresponded to the software of the instrument after the ROM Ver1.200.
 The occupied station number is fixed as 4 before the ROM Ver1.100.

- F-85 Setting the station number of CC-LINK
 (Effective when the option is installed)
 Initial value=00001 Setting range : 00001 to 00061
- F-86 Setting the baud rate of CC-LINK
 (Effective when the option is installed)
 Initial value=00000 00000 : 156 kbps
 00001 : 625 kbps
 00002 : 2.5 Mbps
 00003 : 5 Mbps
 00004 : 10 Mbps
- F-87 Setting of the numeric expression of minus
 Initial value=00000 00000 : Expression of standard binary
 (-1=FFFFFFFFH)
 00001 : At minus, The most significant digit is fixed to "8".
 (-1=80000001H)
- F-88 For maintenance
 ※Do not use here
- F-89 For maintenance
 ※Do not use here
- F-90 Increment value (For reference)
 ※The increment value set when the calibration is applied can be referred to.
 ※The setting cannot be changed in the function.
 ※The reference value here is the value for the selecting calibration data.



Warning ● Never use the following functions because they may destroy the functions at internal of the instrument.

F-00	F-02	F-07	F-13	F-14	F-18	F-19	F-23
F-24	F-25	F-26	F-27	F-28	F-29	F-38	F-39
F-46	F-47	F-48	F-49	F-62	F-63	F-64	F-65
F-66	F-67	F-68	F-69	F-73	F-74	F-75	F-76
F-77	F-78	F-79	F-83	F-95	F-96		

9. Options

The options for the instrument are as follows:

- | | |
|---|-------------------------|
| ① Current output[DC4 mA to 20 mA] | Parts No. : CSD815-P07 |
| ② BCD output | Parts No. : CSD815-P15 |
| ③ CC-LINK interface | Parts No. : CSD815B-P73 |
| [Refer to the instruction manual (DRW. No.294-1435*) for CSD-815B-73] | |
| ④ RS-232C interface | Parts No. : CSD815-P74 |
| ⑤ RS-422/485 interface | Parts No. : CSD815-P76 |

For the options from ① to ⑤, there are some limitations among their combinations as follows :

	P07	P15	P73	P74	P76
P07	—	○	○	○	○
P15	○	—	×	×	×
P73	○	×	—	×	×
P74	○	×	×	—	×
P76	○	×	×	×	—

○ : Possible, × : Impossible

9-1. Current output



● Refer to the paragraph 4-3-5, for the connecting method, and refer to the paragraph 7-15, for their applications.

9-1-1. Related functions

F-20	Target of output	TRACK/Gross weight, PEAK/Net weight
F-21	Display value when the analog output is the minimum value.	Display value at approx. 4 mA output is applied.
F-22	Display value when the analog output is the maximum value.	Display value at approx. 20 mA output is applied.

9-1-2. Specifications for the current output

- | | | |
|---------------------|------------|---|
| (1) Output | Output | : DC4 mA to 20 mA |
| | Over range | : Approx. 2.4 mA with the display “-OL”
Approx. 21.6 mA with the display “OL” |
| (2) Load resistance | | : 260 Ω or less |
| (3) Non-linearity | | : 0.05 %FS. |
| (4) Resolution | | : Approx. 1/12 000 |
| (5) Output rate | | : Synchronous with the display rate
(4 times/s, 20 times/s, 50 times/s, 100 times/s) |

9-2.BCD output



- Warning**
- When power is ON for the instrument with the external HOLD signal shorted, the BCD output will be as follows:
 - ① Even when the Display is targeted for the HOLD with the F-10, BCD outputs “00000” if the target for BCD output is set as Display.
 - ② When the BCD output is assumed to be the target of HOLD with the F-10, BCD output outputs “00000”.
 - ③ Other than the case above ① and ②, the present load value will output after “00000” has output.
 - In other than the Measurement mode, the BCD output will not be renewed. In due course, the “ERROR” for the BCD output won’t be ON in other than the mode of the Measurement mode, so care should be taken fully.
 - When the CHECK switch is applied, pay attention to the following point. By the ON operation of CHECK, the “OL” error display (BCD output is OVR.) might be shown.

9-2-1. Related function

F-40	Setting the target of BCD output	TRACK/Gross weight, PEAK/Net weight
F-41	Setting output logic for BCD data	Negative logic, Positive logic
F-42	Setting output logic for BCD polarity	Negative logic, Positive logic
F-43	Setting output logic for BCD flag	Negative logic, Positive logic
F-44	Setting output logic for BCD PC.	Negative logic, Positive logic
F-45	Setting the width of BCD PC.	5 ms, 10 ms, 25 ms, 125 ms

9-2-2. Specifications for BCD output

(1) Output logic

Relative function Negative logic, Positive logic can be changeable by the related functions F-41, F-42, F-43 and F-44.

(2) Output data

BCD 5 digits parallel output
 POL. (Polarity) ON at minus, and output OFF at plus.
 PC. (Print command)
 ERROR
 OVR. (Over)

(3) Input data ZERO Same as  key

PEAK/TRACK/A/Z Same as  key

RESET/A/Z OFF Same as  key

HOLD Display, Hold of BCD output

BCD-ENABLE Compulsive OFF for the related output with BCD (High-impedance)

SEL.1, SEL.2 As same as SEL.1 and SEL.2 for external control input signal.

(4) Output target Change of TRACK/gross weight, change of PEAK/Net weight can be available with the related function F-40.

(5) Output times Synchronous with the display times (F-03)
4 times/s, 20 times/s, 50 times/s, 100 times/s

9-2-3. Pin configurations for the BCD output connector

1	COM.	13	8×10^2	25	ERROR
2	1×10^0	14	1×10^3	26	PC.
3	2×10^0	15	2×10^3	27	HOLD
4	4×10^0	16	4×10^3	28	N.C.
5	8×10^0	17	8×10^3	29	SEL.1
6	1×10^1	18	1×10^4	30	SEL.2
7	2×10^1	19	COM.	31	ZERO
8	4×10^1	20	2×10^4	32	A/Z
9	8×10^1	21	4×10^4	33	A/Z OFF
10	1×10^2	22	8×10^4	34	N.C.
11	2×10^2	23	POL.	35	BCD-ENABLE
12	4×10^2	24	OVR.	36	N.C.

Suitable plug : 57-30360 made by DDK



- Never connects with the N.C. pins.
- An internal circuit and each pin of BCD output connector are insulated by photocoupler.
- In case of conforming CE conformity standard to this instrument, make sure using shielded cables and connectors attached metallic shells then shield and connector's metallic shell parts are attached directly.

9-2-4. Equivalent circuit for input/output

(1) Equivalent circuit for input

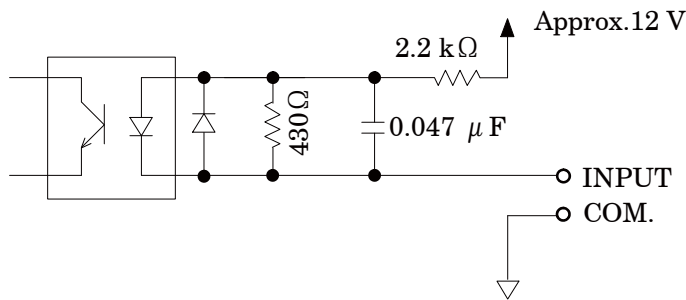

(2) Equivalent circuit for output

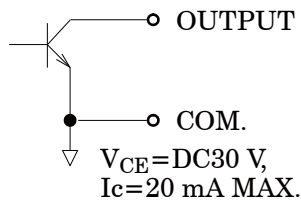

9-2-5. Timing chart



Warning ● In case of reading each output data of the BCD output through the sequencer and so on, read them at the timing of “The edge from ON to OFF” for the P.C. (Print command). Moreover, read the “Input response delay time” for the reading instrument such as a sequencer and so on, with full considerations. If neglected, there may have the possibility that correct reading of data will not be obtained.

(1) Normal

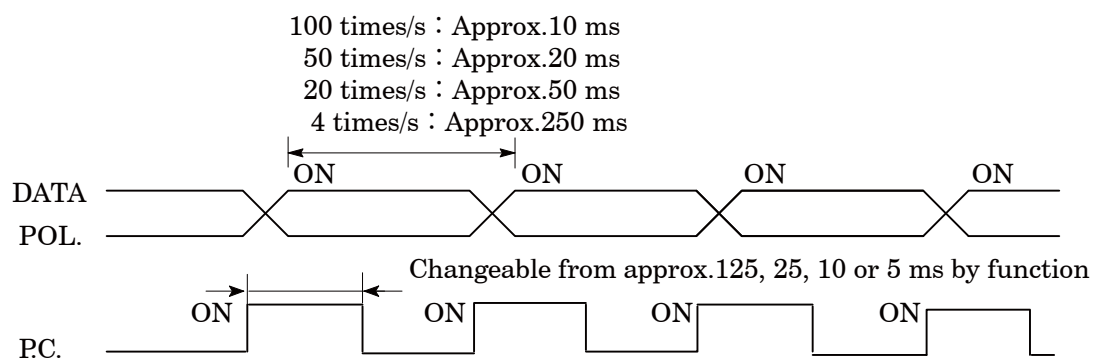

● At the time of data output of each P.C., DATA and POL., output transistor will become ON (Negative logic electrically).

(2) When the data is over-ranged

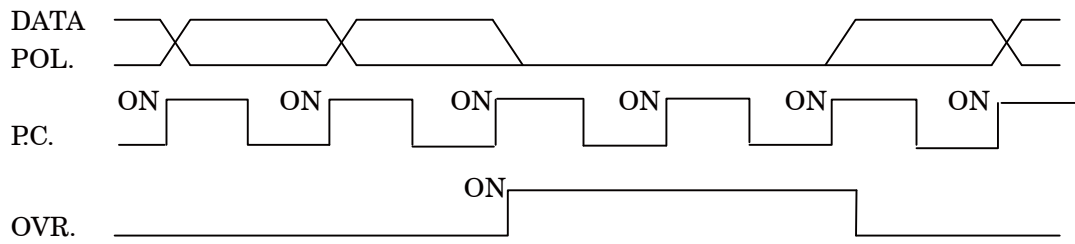

- At the time of OVR output, output transistor will at the OVR signal will become ON(Negative logic electrically). Moreover, for all of the DATA, output transistor will become OFF (Positive logic electrically) at the time of OVR output. (However, for the POL., normal OFF at the “OL”, and normal ON at the “-OL”.

(3) When ERROR is occurred

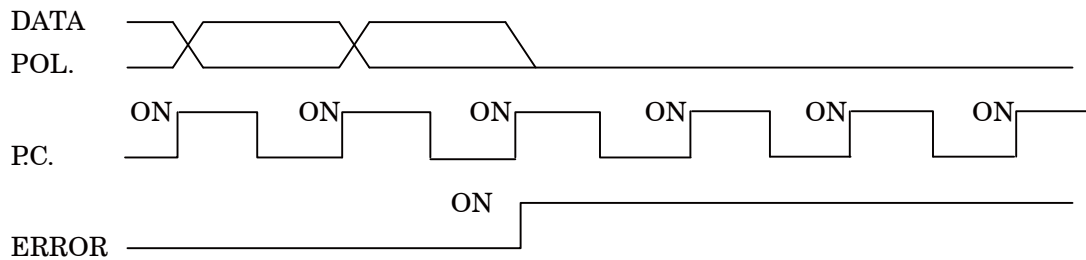

- At the time of ERROR output, output transistor at ERROR signal will become ON(Negative logic electrically). Moreover, for each DATA, POL., all of the output transistor will become OFF at the time of ERROR output(Positive logic electrically).

(4) When the HOLD signal is input

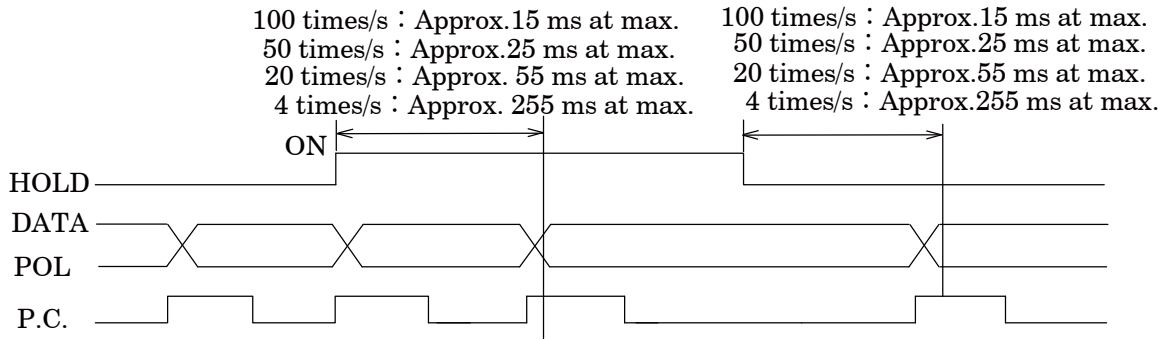

- At the time of HOLD signal input, output transistor for the P.C. will be OFF condition. (Positive logic electrically.)(However, for P.C.,OFF condition will be made after one(1) shot of operation.)
- After inputting the HOLD signal, it takes the following response times to freeze the DATA, POL or cancellation of HOLD is executed.
 - At the time of 100 times/s : Approx. 15 ms at maximum
 - At the time of 50 times/s : Approx.5 ms at maximum
 - At the time of 20 times/s : Approx.55 ms at maximum
 - At the time of 4 times/s : Approx.255 ms at maximum

9-2-6. Output condition

Setting output logic	Output data	Condition of transistor	Pin-COM level at the time of voltage supply externally.
Negative logic	Yes	ON	L
	No	OFF	H
Positive logic	Yes	OFF	H
	No	ON	L

9-2-7. Selection of output logic for P.C.(Print command), and selection of its width

Selection of the P.C. logic for BCD output, and its width can be made by setting function. (Related function : F-44, F-45)

Select the P.C. width to meet with the display rate set by F-03, and execute the suitable selection according to the following list.

Display rate (F-03)	P.C. width			
	Approx.125 ms	Approx.25 ms	Approx.10 ms	Approx.5 ms
4 times/s	○	○	○	○
20 times/s	×	○	○	○
50 times/s	×	×	○	○
100 times/s	×	×	×	○

○ : Possible to use, × : Impossible to use.(P.C. output doesn't operate correctly.)

 **Warning** ● The selection of P.C. width should be made adequately according to the display times set with the F-03. If neglected, the P.C. output will not operate correctly.



- Warning**
- In other than the mode of Measurement mode, such as in Function mode, Calibration mode, Fine adjustment mode and Setting mode, the Error command will be send against the command from the Host.
 - When the CHECK switch is applied, pay attention to the following points.
 - ① By ON operation of the CHECK, the instrument isn't in the Measurement mode anymore, however RS-232C interface responses to the command from the host.
 - ② By ON operation of the CHECK, "OL" error display might be shown. At this time, when reading command for load is executed, the "OL" will be transferred to the host.

9-3-1. Related function

F-50	Setting the operation mode	Stream mode, Command mode
F-51	Setting the output target at the time of stream mode	TRACK/Gross weight, PEAK/Net weight
F-52	Setting the baud rate	1 200, 2 400, 4 800, 9 600, 19 200 or 38 400 bps
F-53	Setting data bit length & parity	Parity bit : Non, Even parity, Odd parity Data length : 7 bit, 8 bit
F-54	Setting the stop bit	1 bit, 2 bit
F-55	Setting the terminator	CR, CR+LF
F-56	Setting decimal point for sending code	No or Yes



- Setting of this function makes the setting activated immediately after setting.

9-3-2. Specifications for interface

- (1) Method Corresponds to RS-232C
- (2) Communication method Half duplex
- (3) Specifications for signal
 - Baud rate 1 200, 2 400, 4 800, 9 600, 19 200 or 38 400 bps
 - Data length 7 bit or 8 bit
 - Parity bit Non, Even parity or Odd parity
 - Stop bit 1 bit or 2 bit
 - Terminator CR or CR+LF
 - Synchronous method Start-stop synchronous method
 - Transmission data ASCII code
- (4) Cable length Within 15 m
- (5) Input/Output monitor with LED

9-3-3. Procedures of data transfer

There are two kinds of data transfers in the instrument, that is, stream mode and command mode.

(1) Stream mode

The latest targeted data targeted/selected with the F-51 keep on outputting. However, output times will change depending on the setting of display times and baud rate.

(2) Command mode

By sending the determined command/data from the host (Personal computer, sequencer and so on) to the CSD-815B, the data will be send back to the host side from the CSD-815B corresponding to the command/data.

Be sure to execute communication according to the below procedures.

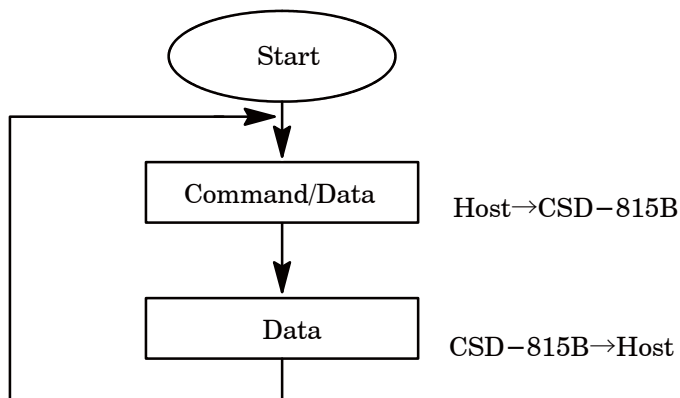

- The communication operation can be made in all of the modes. However, in the Function mode, Calibration mode, Fine adjustment mode and Setting mode, the Error command will be sent.
- The flow control is not executed in the CSD-815B.
- The CTS/RTS signal is not applied.
- The X flow control is not performed.
- The operating communication is a conversational dialogue type.

9-3-4. Pin configurations for connector pin

(1) Pin configuration

Pin No.	Signal Name
1	CD
2	TXD
3	RXD
4	N.C.
5	S.G.
6	N.C.
7	RTS
8	CTS
9	N.C.

Suitable plug : DE-9S-NR by JAE or equivalent. ※Not attached.



- The screws for the fixing base of plug at the connector of RS-232C interface is inch type thread.
- An internal circuit and each pin of RS-232C interface connector are insulated by photocoupler.
- In case of conforming CE conformity standard to this instrument, make sure using shielded cables and connectors attached metallic shells then shield and connector's metallic shell parts are attached directly.

(2) Example of connection at the RS-232C interface

① Example 1

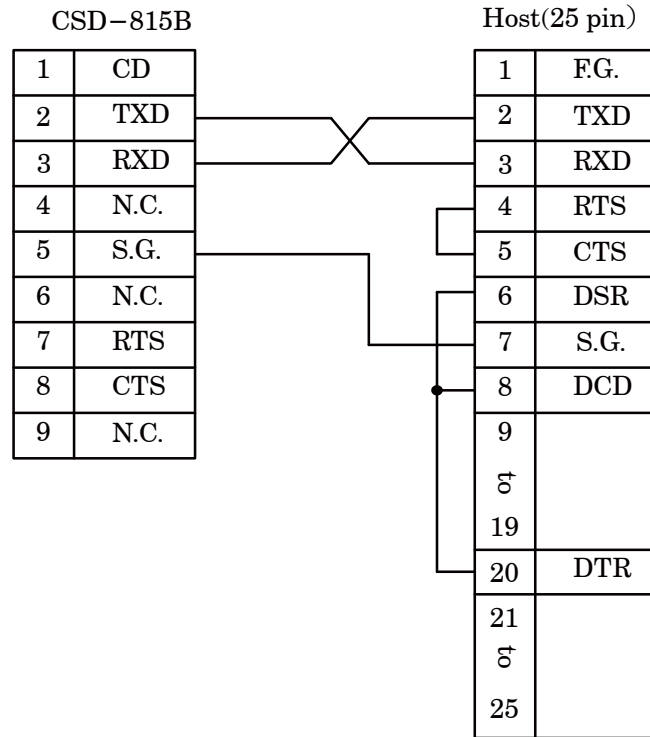

② Example 2

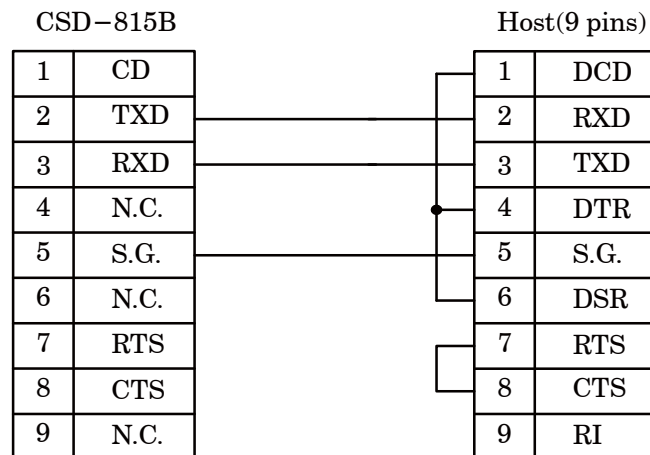

② Reading out comparative data (Host→CSD-815B)

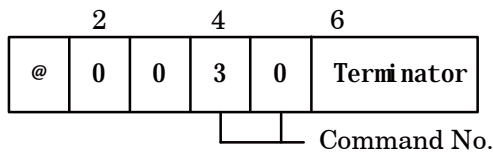

Command No.	Operation
30	Reading out S0 data
31	Reading out S1 data
32	Reading out S2 data

Return(CSD-815B→Host)

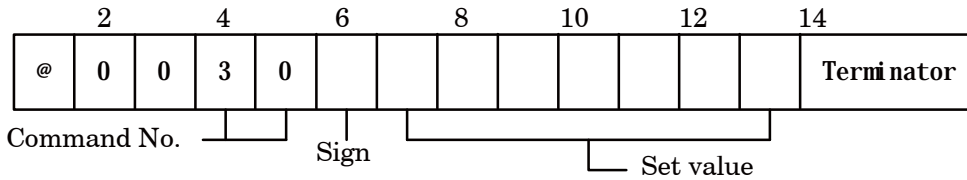

- The load data enters from the right end.
- When the data is minus, “-” sign and when plus, “+” sign is added.
- The sign data performs zero suppress.
- In case that the decimal point is set with the F-56, and at the same time the decimal point is specified with the F-01, it will be added to the specified position.
- The empty sections are all spaces.

③ 3. Reading-out the condition (Host→CSD-815B)

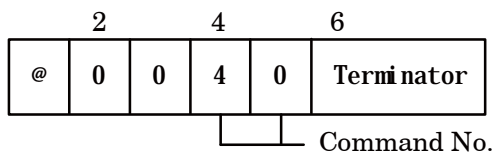

Command No.	Operation
40	Reading out the condition

Return(CSD-815B→Host)

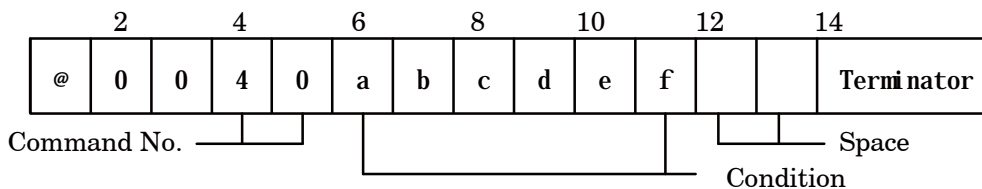

- a : ◎ LED display “1”=ON, “0”=OFF
- b : HOLD LED display “1”=ON, “0”=OFF
- c : A/Z LED display “1”=ON, “0”=OFF
- d : CHECK LED display “1”=ON, “0”=OFF
- e : PEAK LED display “1”=ON, “0”=OFF
- f : BOTTOM LED display “1”=ON, “0”=OFF

9-3-6. Communication error process

The instrument returns the error command to the host side at the time of Communication error or Execution error.

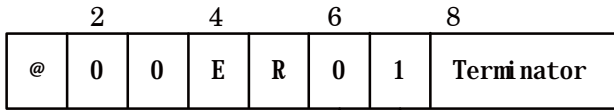

Error Command No.

Error Command No.	Contents	Remarks
01	Error of impossible condition of execution	In the case of Function mode, Calibration mode, Fine adjustment mode and Setting mode.
02	Another error caused from the instrument	In the case of impossible to execute the receiving command.
10	Parity error	In the case of detecting the parity error.
11	Framing error	In case of detecting error for stop bit.
12	Overrun error	In the case of reading error for receiving command.
13	Error of data code, data length error	The receiving data code and data length are not the same.
14	No applicable command	The receiving command isn't the same.



- In case that the Completion code (terminator) is not detected, the error code will not be returned.
- In case that the communication error command is returned from the instrument, consider its remedy at the host side.



- Warning**
- The error code will be sent against the command from the host during other than the mode of Measurement mode, such as in the Calibration mode, Fine adjustment mode, and Setting mode.
 - When CHECK switch is ON status, take care of the following points.
 - ① When CHECK switch will be ON status, the instrument will be out of the Measurement mode, but RS-422/485 interface will make response to the command from the Host.
 - ② By ON operation of CHECK, there may be a case that display will show as “OL” error. At the same time, executing the reading command for load makes the “OL” transmitted to the Host.
 - The sending terminal is low impedance for 1 ms after finishing sending in the instrument. Therefore, to prevent from competing with other instruments, apply the sending wire (SDA, SDB) at the intervals of 1ms or more.

9-4-1. Related functions

F-52	Setting baud rates	1 200, 2 400, 4 800, 9 600, 19 200 or 38 400 bps
F-53	Setting a data bit length and a parity bit length	Parity bit : Non, Even and Odd parity Data length : 7 bit, 8 bit
F-54	Setting a stop bit	1 bit, 2 bit
F-55	Setting the terminator	CR, CR+LF
F-56	Setting the decimal point in transmitting code	Non, Exist
F-57	Setting the ID No.	0to31
F-58	Change of RS-421/485	Operation of RS-422, operation of RS-485
F-59	Setting the delay time for sending back the RS-485	Every 1 ms 0to999 1 ms (unit)



- The setting of this function will be effective immediately after setting the function.
- The function F-59 will become effective at the time of operation of RS-485.
After completing the transmission at the host side by the function, set the time until the transmitting terminal of the instrument becomes high impedance.

9-4-2. Specifications on interface

- (1) Method Based on RS-422/485
- (2) Communication method Half-duplex
- (3) Specifications on Signal
 - Baud rate 1 200, 2 400, 4 800, 9 600, 19 200 or 38 400 bps
 - Data bit length 7 bit, 8 bit
 - Parity bit None, Even and Odd parity
 - Stop bit 1 bit, 2 bit
 - Terminator CR or CR+LF
 - Synchronous method Start-stop synchronous method
 - Communication data ASCII code
 - Address 00 to 31
- (4) Cable length Approx.1 km
- (5) Number of connections 32 sets at maximum (RS-422: 10 sets)
- (6) Termination Built-in
(Yes/No can be selectable by the connection of terminal boards.)
- (7) Change of RS-422/485 Setting by the function.
- (8) Input/output monitor With LED
(The layout is shown on the P.C. board at rear side of terminal board.)

9-4-3. Procedure of data transmission

By sending the determined command/data from the host (personal computer, sequencer and so on) to the CSD-815B, data will be sent back to the host side from the CSD-815B corresponding to the command/data.

Be sure to execute communication according to the below procedures.

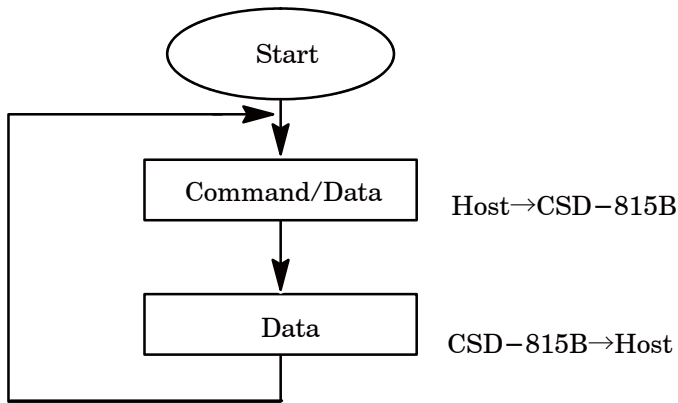



- The communicating operation can be made in all of the modes.
However, the error command will be transmitted in the Function mode, Calibration mode, Fine adjustment mode and the Setting mode.
- The flow control is not executed in the CSD-815B.
- The CTS/RTS signal is not applied.
- The X flow control is not performed.
- The communication operation is a conversational type.

9-4-4. Pin layout and wiring of Connector

(1) Pin configuration

SDA	Differential output (+)
SDB	Differential output (-)
RDA	Differential input (+)
RDB	Differential input (-)
TRM.	Terminator
S.G.	Signal ground



- The TRM. is a terminal resistance. Connect the terminal resistance by shorting between the TRM. and RDM. at the last end of the host looking from the host (personal computer, sequencer and so on).
- For the connection, we recommend to apply twisted pair wires.
- An internal circuit and each pin of RS-422/485 interface terminal are insulated by photocoupler.
- In case of conforming CE conformity standard to this instrument, make sure using shielded cables and connect the shielded wire with F.G. terminal (Terminal block 2 Terminal No.3).

(2) Example of connection

① 1 to 1

RS-422

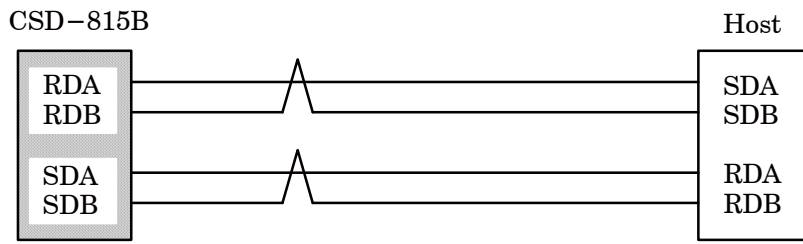

RS-485

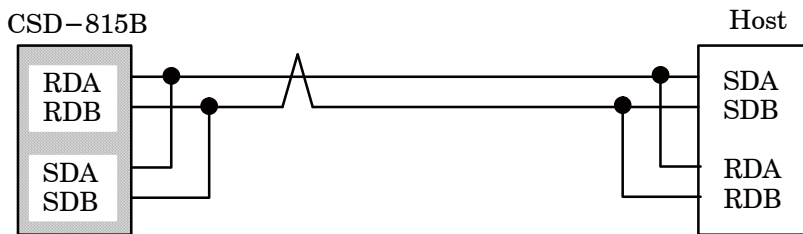

Connect the terminal resistance at the  section.

② 1 to n

RS-422

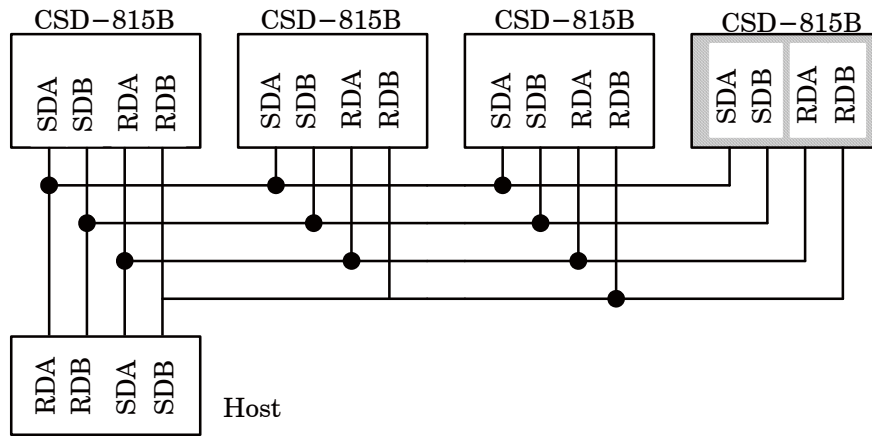

RS-485

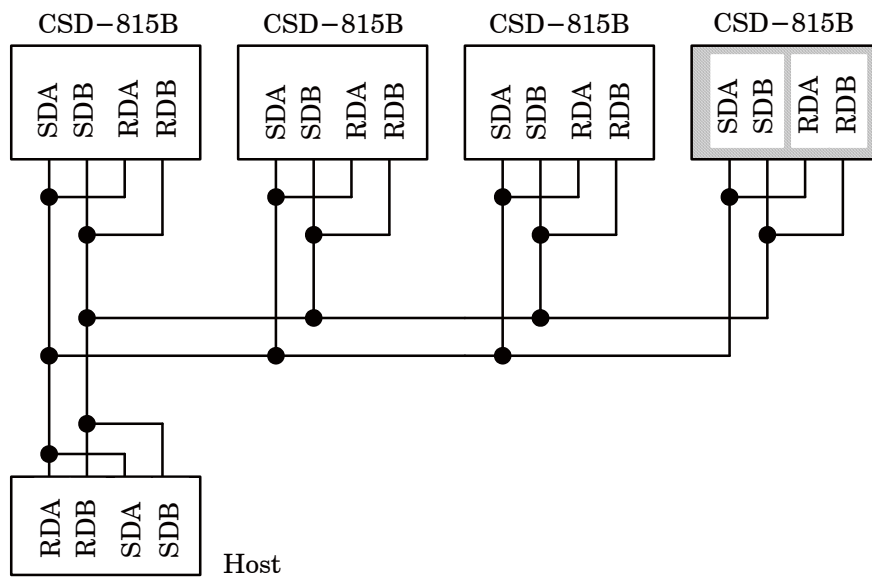

Connect the terminal resistance at the  section.

9-4-5. Data format

(1) Command mode

① Reading out the load data(Host→CSD-815B)

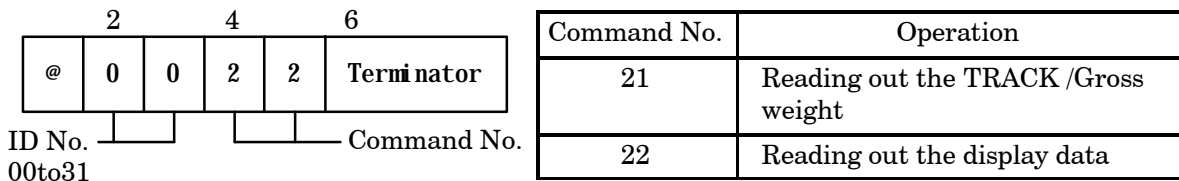

Return(CSD-815B→Host)

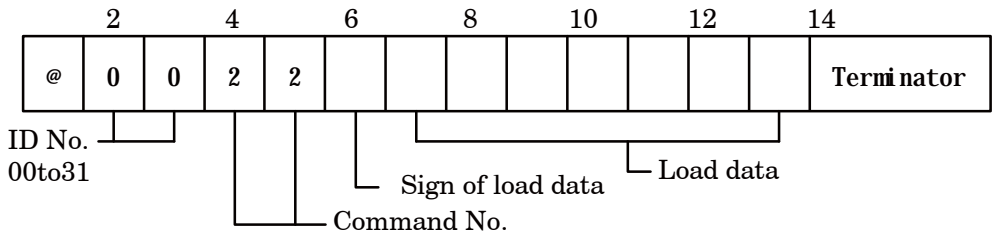

- The comparative data enters from the right end.
- When the data is minus, “-” sign and when plus, “+” sign is added.
- The sign data perform zero suppress.
- When the decimal point is set with the F-56 and at the same time the decimal point is determined with the F-01, it will be added to the specified position.
- The message will be output at the time of overload.
- The empty sections are all spaces.

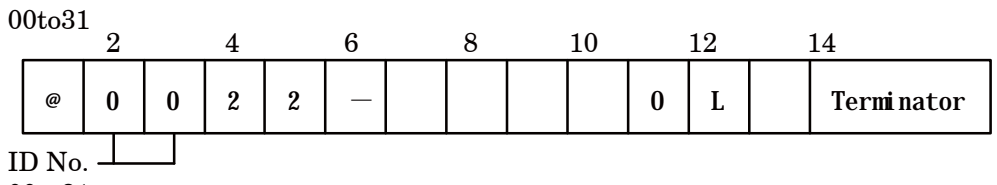
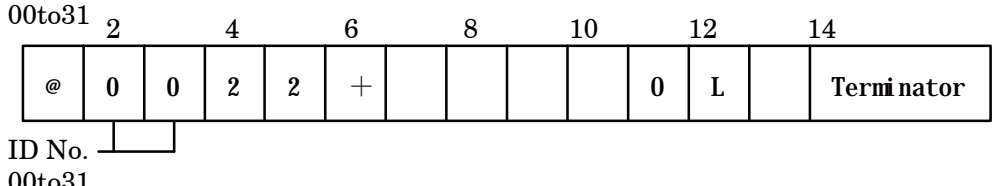
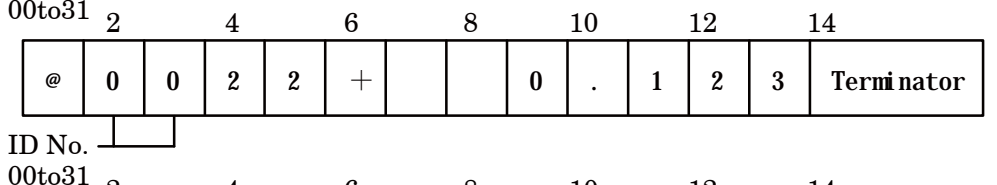
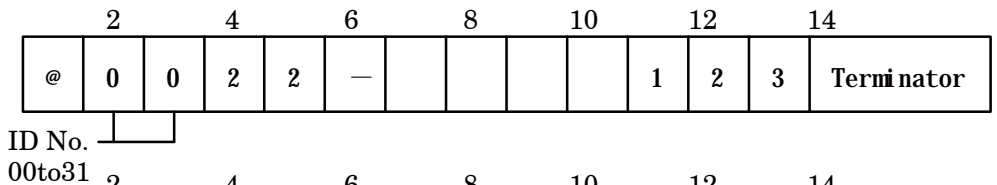

② Reading-out the comparative data (Host→CSD-815B)

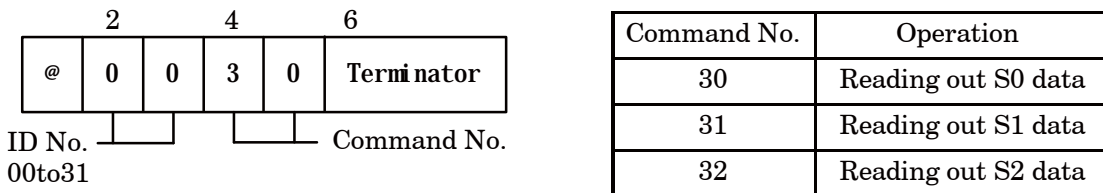

Return(CSD-815B→Host)

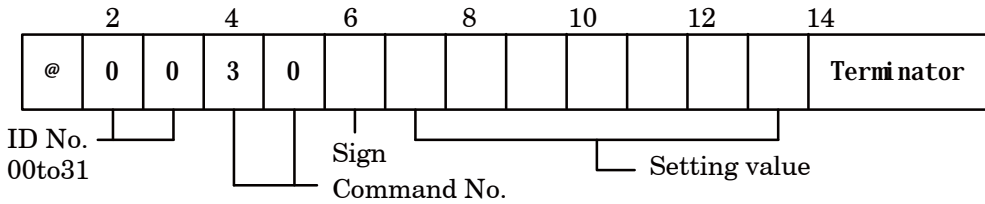

- The comparative data enter from the right end.
- When the data is minus, “-” sign and when plus, “+” sign is added.
- The sign data perform zero suppress.
- When the decimal point is set with the F-56 and at the same time the decimal point is determined with the F-01, it will be added to the specified position.
- The empty sections are all spaces.

③ Reading-out the status (Host→CSD-815B)

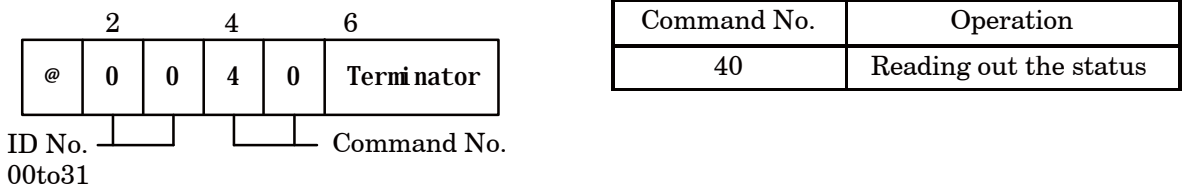

Return(CSD-815B→Host)

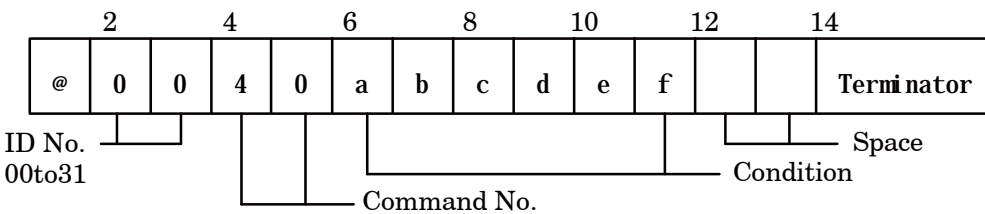

- a : ☉ LED display “1”=ON, “0”=OFF
- b : HOLD LED display “1”=ON, “0”=OFF
- c : A/Z LED display “1”=ON, “0”=OFF
- d : CHECK LED display “1”=ON, “0”=OFF
- e : PEAK LED display “1”=ON, “0”=OFF
- f : BOTTOM LED display “1”=ON, “0”=OFF

④ Reading—out the comparative result (Host→CSD-815B)

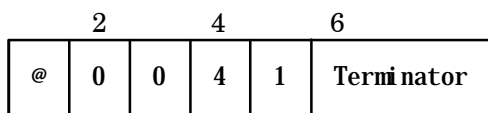

Command No.	Operation
41	Read out comparative result

ID No. 00to31
Command No.

Return(CSD-815B→Host)

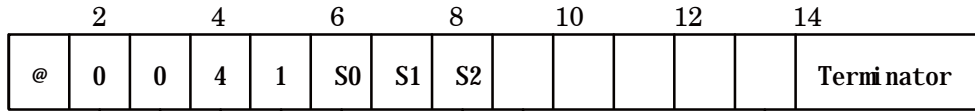

ID No. 00to31
Command No.
Condition
Space

S0 : "1" = ON, "0" = OFF

S1 : "1" = ON, "0" = OFF

S2 : "1" = ON, "0" = OFF

⑤ Change of status (Host→CSD-815B)

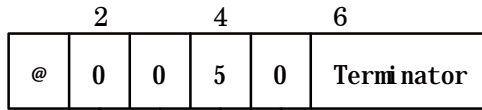

Command No.	Operation
50	Zero set
51	PEAK/TRACK, A/Z
52	RESET, A/Z OFF

ID No. 00to31
Command No.

Return(CSD-815B→Host)

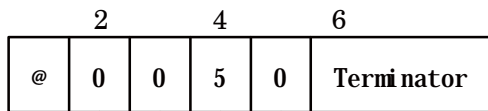

ID No. 00to31
Command No.

⑥ Writing comparative data (Host→CSD-815B)

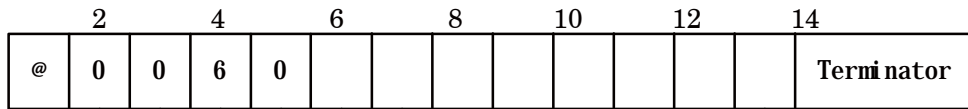

ID No. 00to31
Command No.
Sign
Set value

Command No.	Operation
60	Writing S0 data
61	Writing S1 data
62	Writing S2 data

Return(CSD-815B→Host)

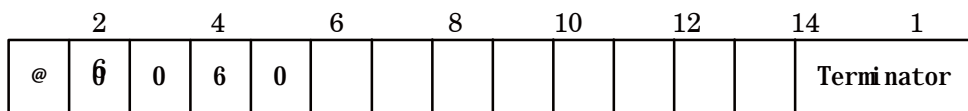

ID No. 00to31
Command No.
Sign
Set value

- The comparative data enters from the right end.
- The setting range is within -99 999 to 99 999.
- Do not add a decimal point.

9-4-6. Process of communication error

The instrument sends back the error command to the host side at the time of occurrence of communication error or executing error.

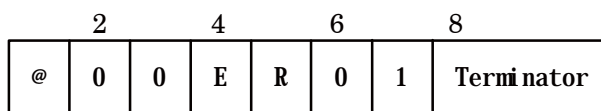

ID No. Error Command No.

Error Command No.	Contents	Remarks
01	Error of status of impossible to execute	During the Function mode, Calibration mode, Fine adjustment mode and Setting mode.
02	Another error caused from the instrument	In the case of impossible to execute the receiving command.
10	Parity error	In the case of detecting the parity error.
11	Framing error	In case of detecting error for stop bit.
12	Overrun error	In the case of reading error for receiving command.
13	Error of data code, data length error	The receiving data code and data length are not the same.
14	No applicable command	The receiving command isn't the same.



- In case that the ID number and the Completion code (terminator) is not detected, the error command will not be returned.
- In case that the communication error command is returned from the instrument, consider its remedy at the host side.

10. Trouble shooting

When abnormal point(s) is/are found during the operation of the instrument, check by the following procedures. However, when you can't find applicable item nor solve the symptom of trouble even after you have taken some measures, contact with Minebea.

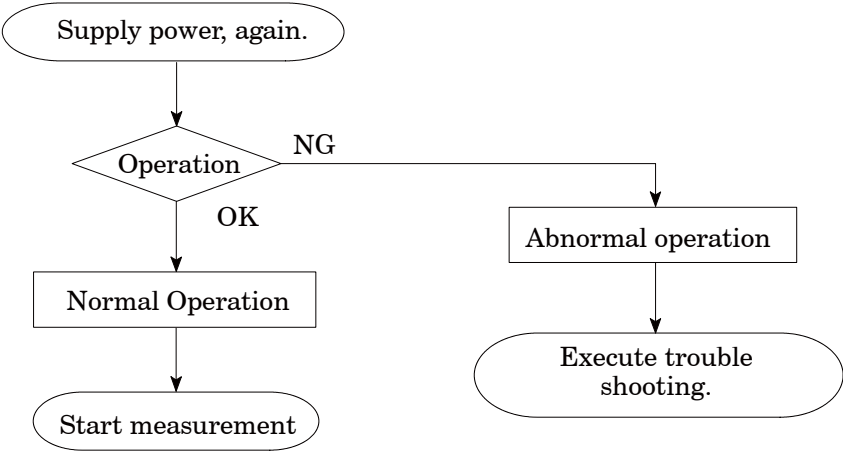

10-1. Execute trouble shooting

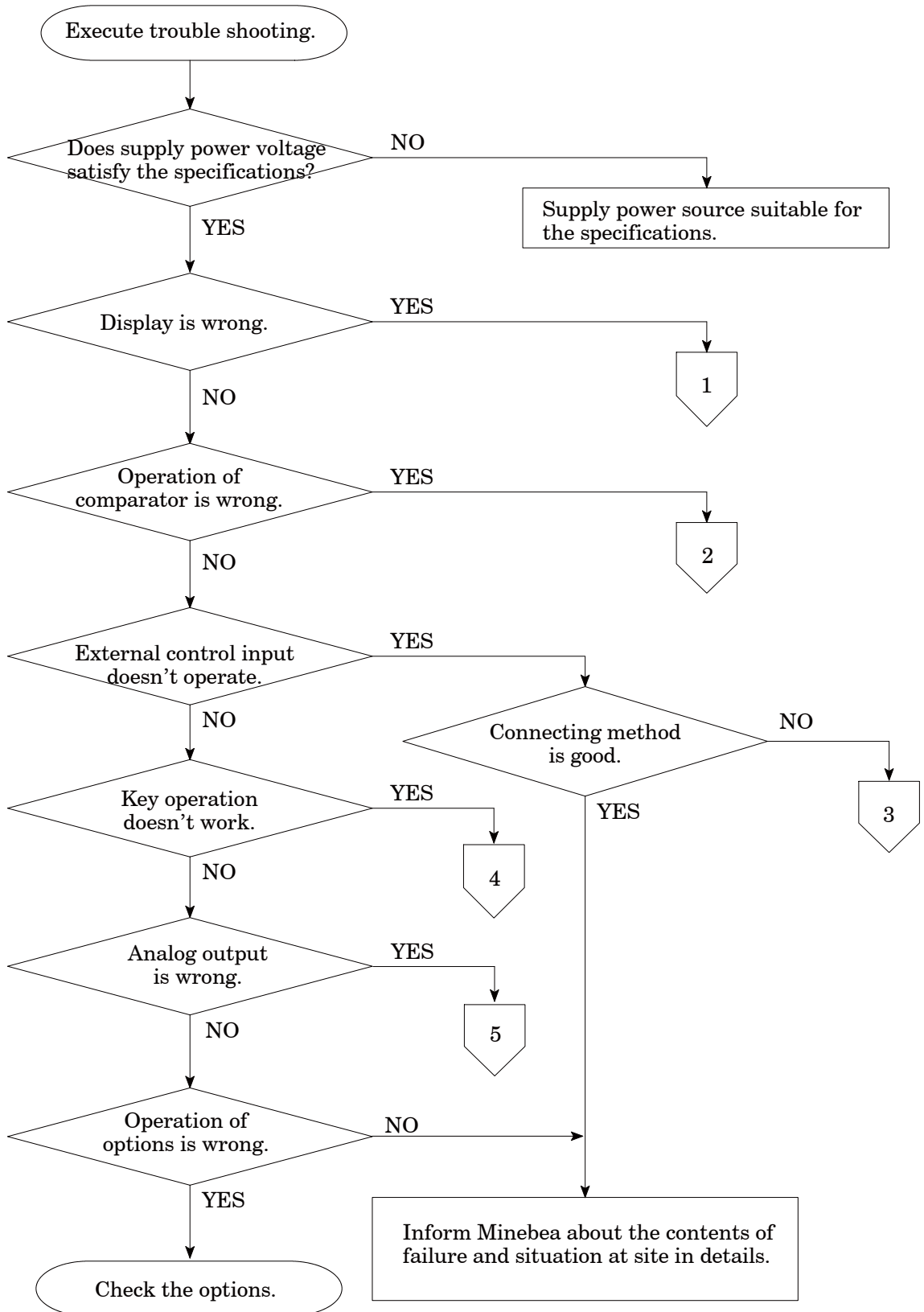

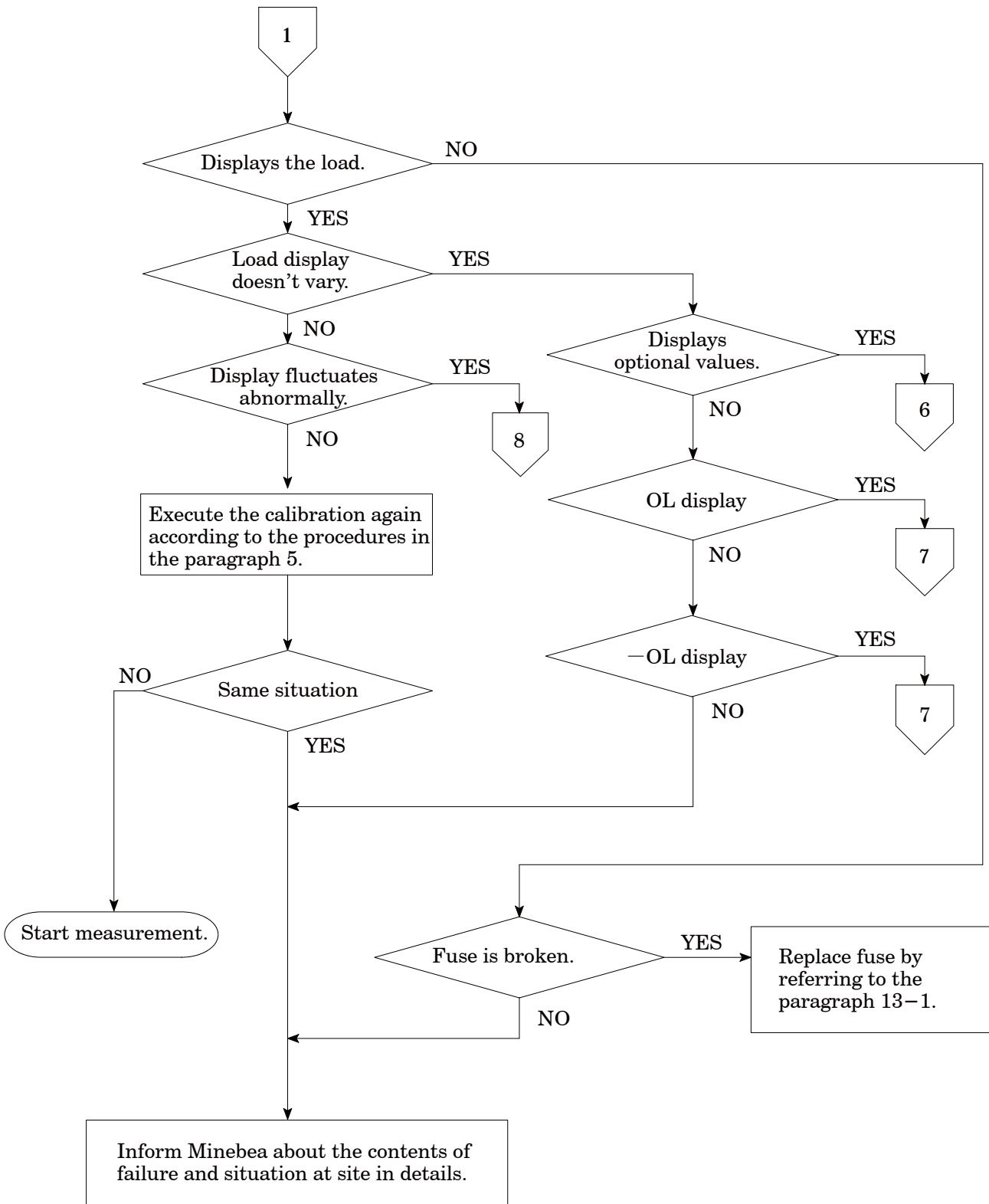

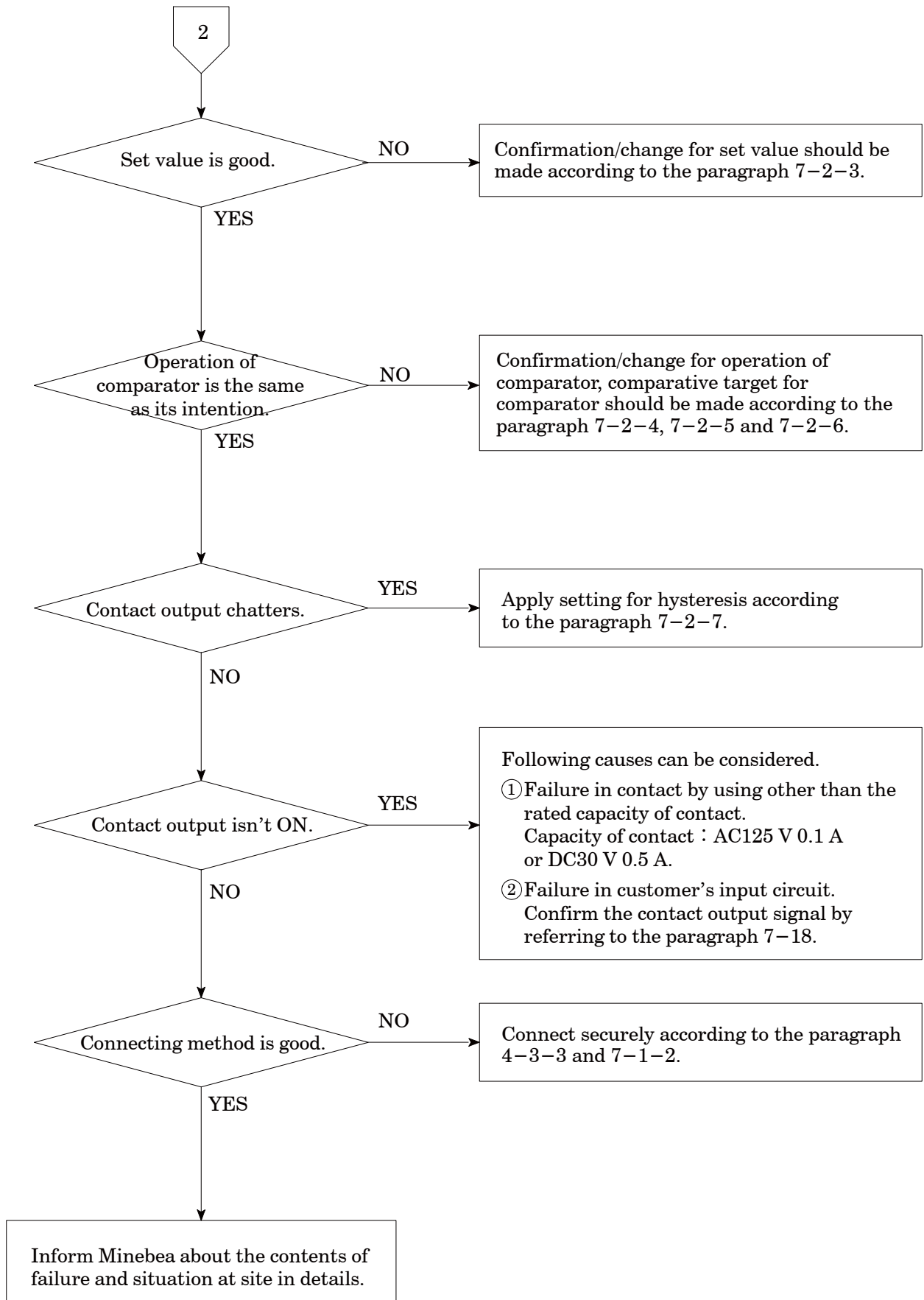

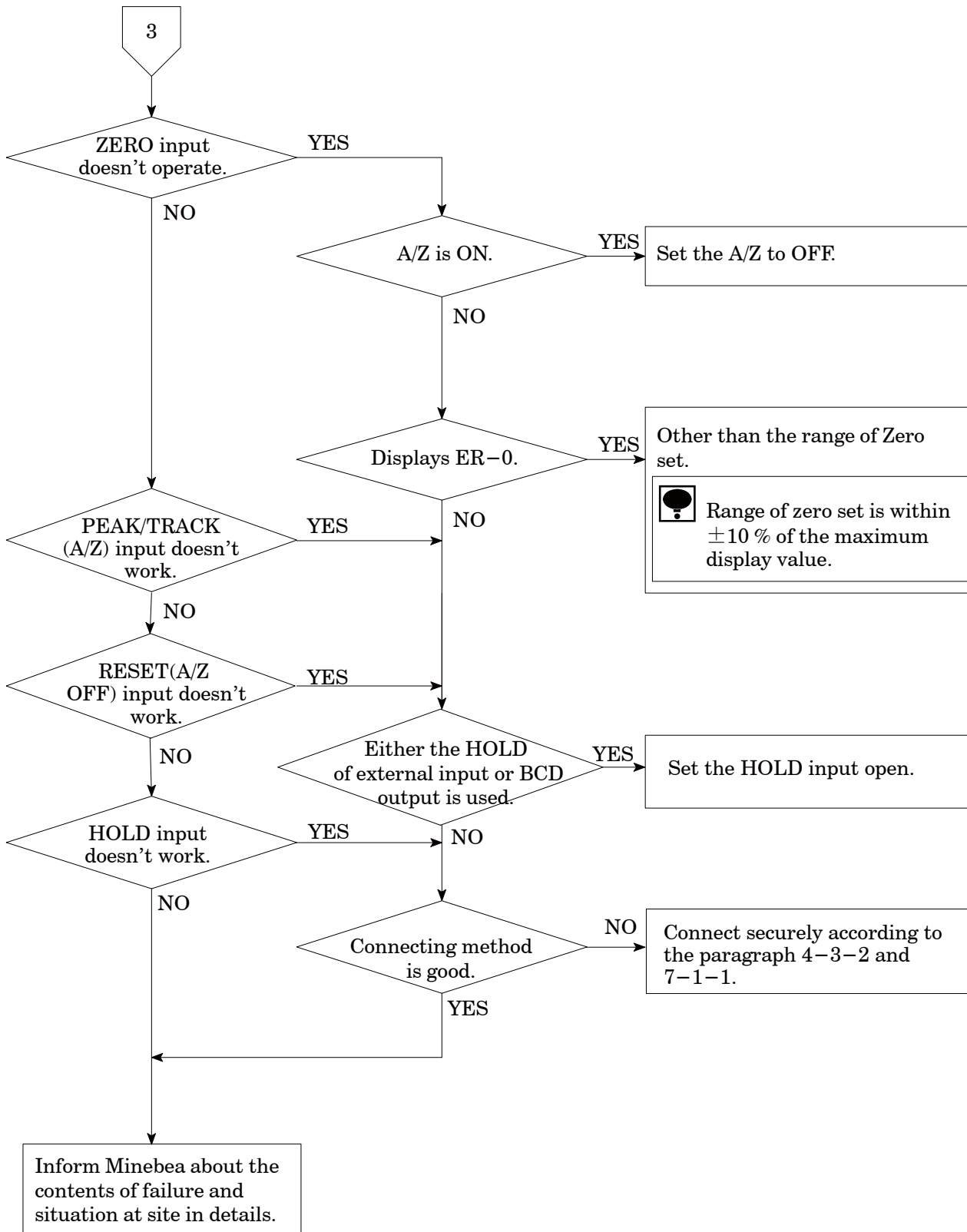

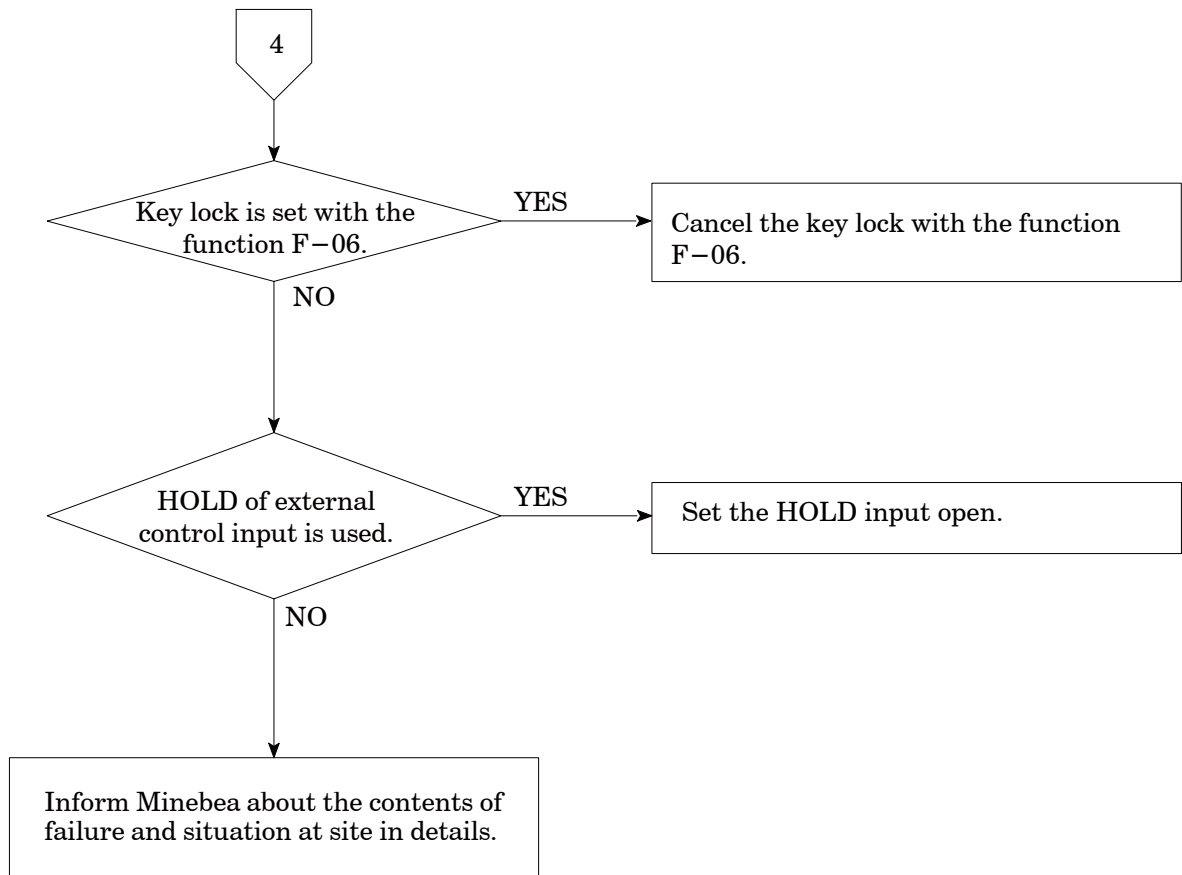

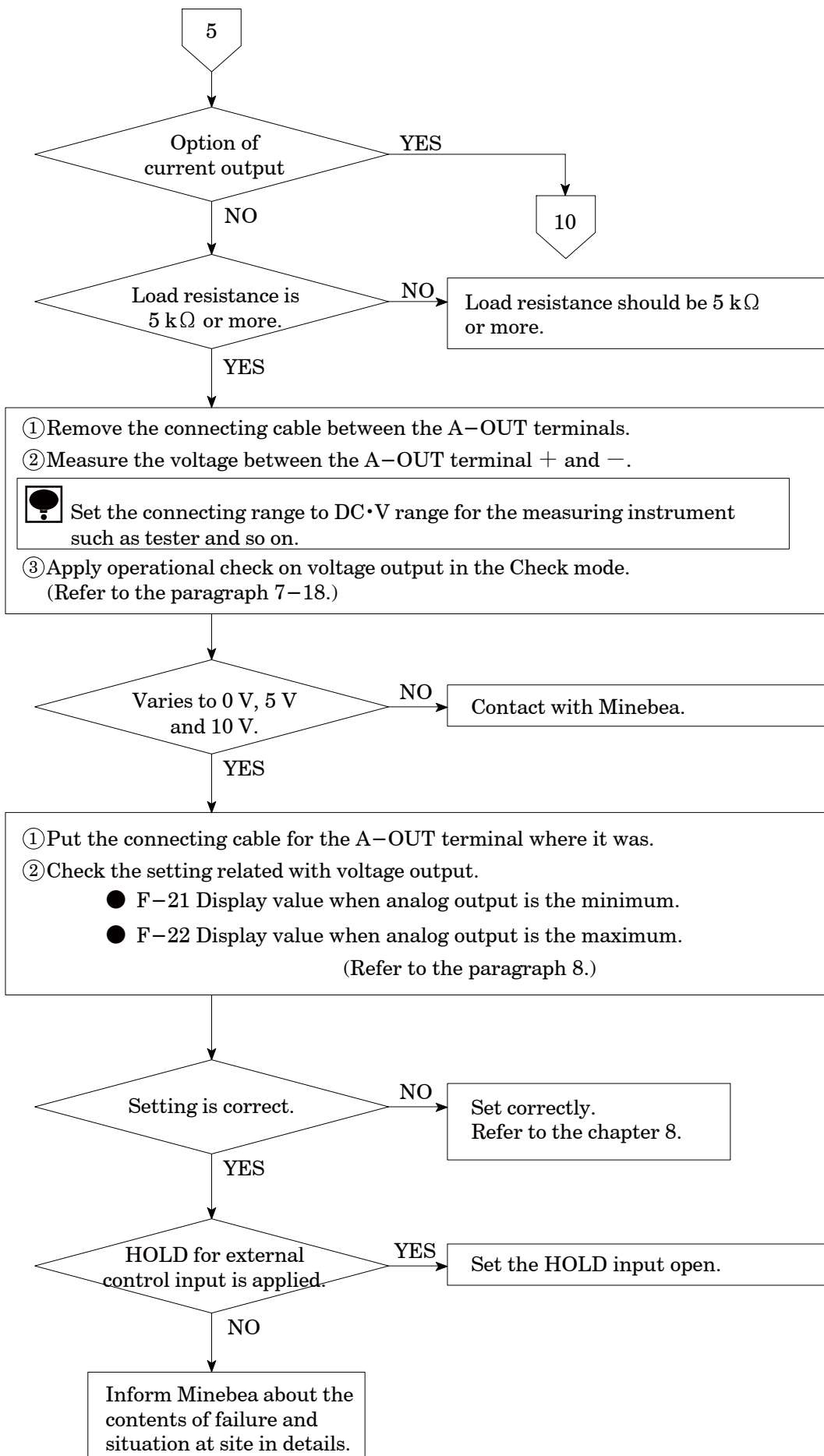

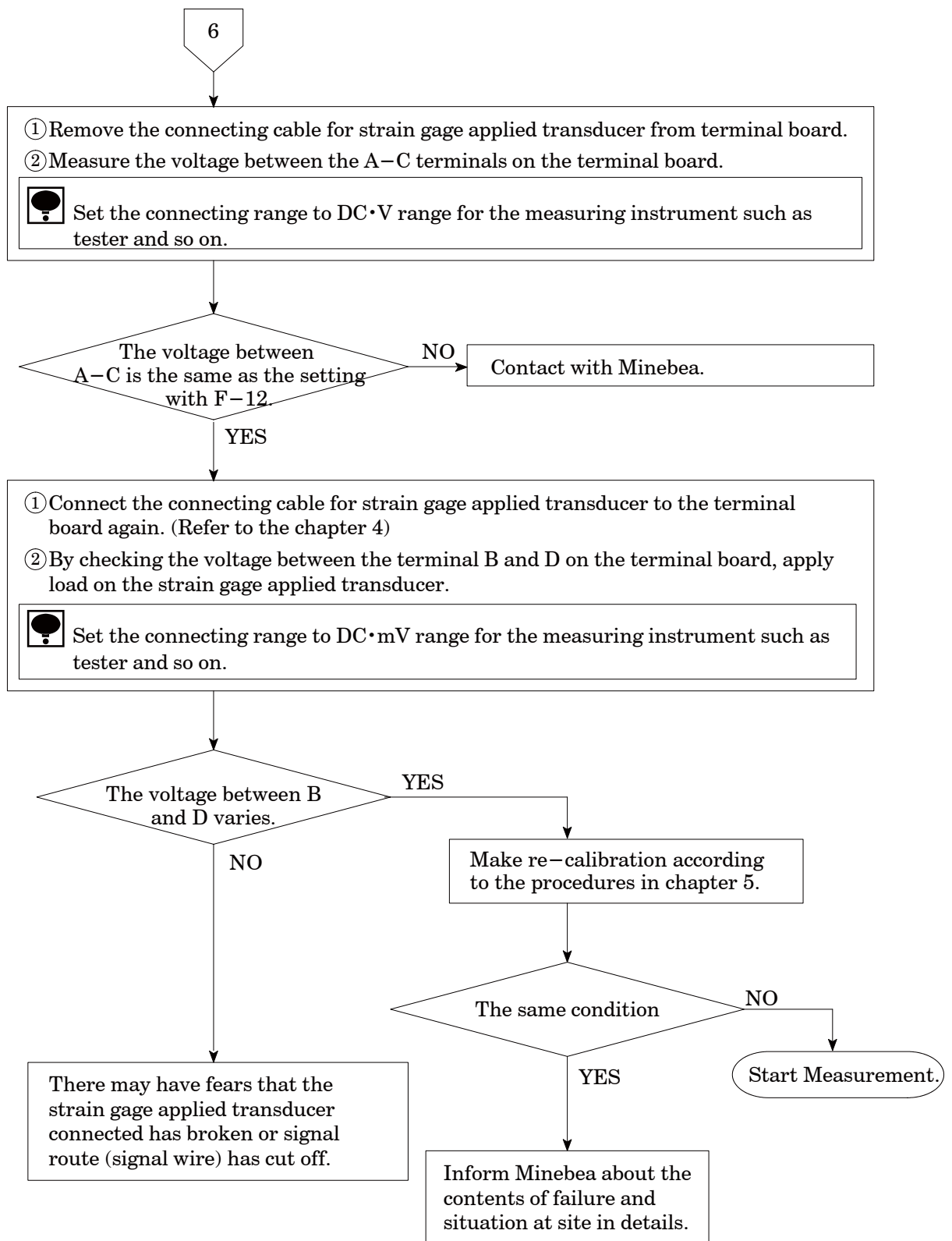

7

- ① Remove the connecting cable for strain gage applied transducer from the terminal board.
- ② Measure the voltage between the A-C terminals on the terminal board.



Set the connecting range to DC·V for the measuring instrument such as tester and so on.

The voltage between A-C is the same as the setting with F-12.

NO

Contact with Minebea.

YES

- ① Connect the connecting cable for strain gage applied transducer to the terminal board again. (Refer to the chapter 4.)
- ② Set the load display section to be the monitoring condition for strain gage applied transducer according to the paragraph 7-19.

Monitoring display exceeds the range from -2.4 mV/V to 2.4 mV/V .

YES

Short between B-D on the terminal board.

NO

Make re-calibration according to the procedures of chapter 5.

Monitoring display exceeds the range from -2.4 mV/V to 2.4 mV/V .

NO

Same condition

YES

YES

Following causes can be considered

- ① The input of strain gage applied transducer exceeds the range from -2.4 mV/V to 2.4 mV/V .
- ② The strain gage applied transducer has broken due to overload and so on.
- ③ The strain gage applied transducer connected has broken or signal route (signal wire) has cut off.

NO

Start measurement.

Inform Minebea about the contents of failure and situation at site in details.

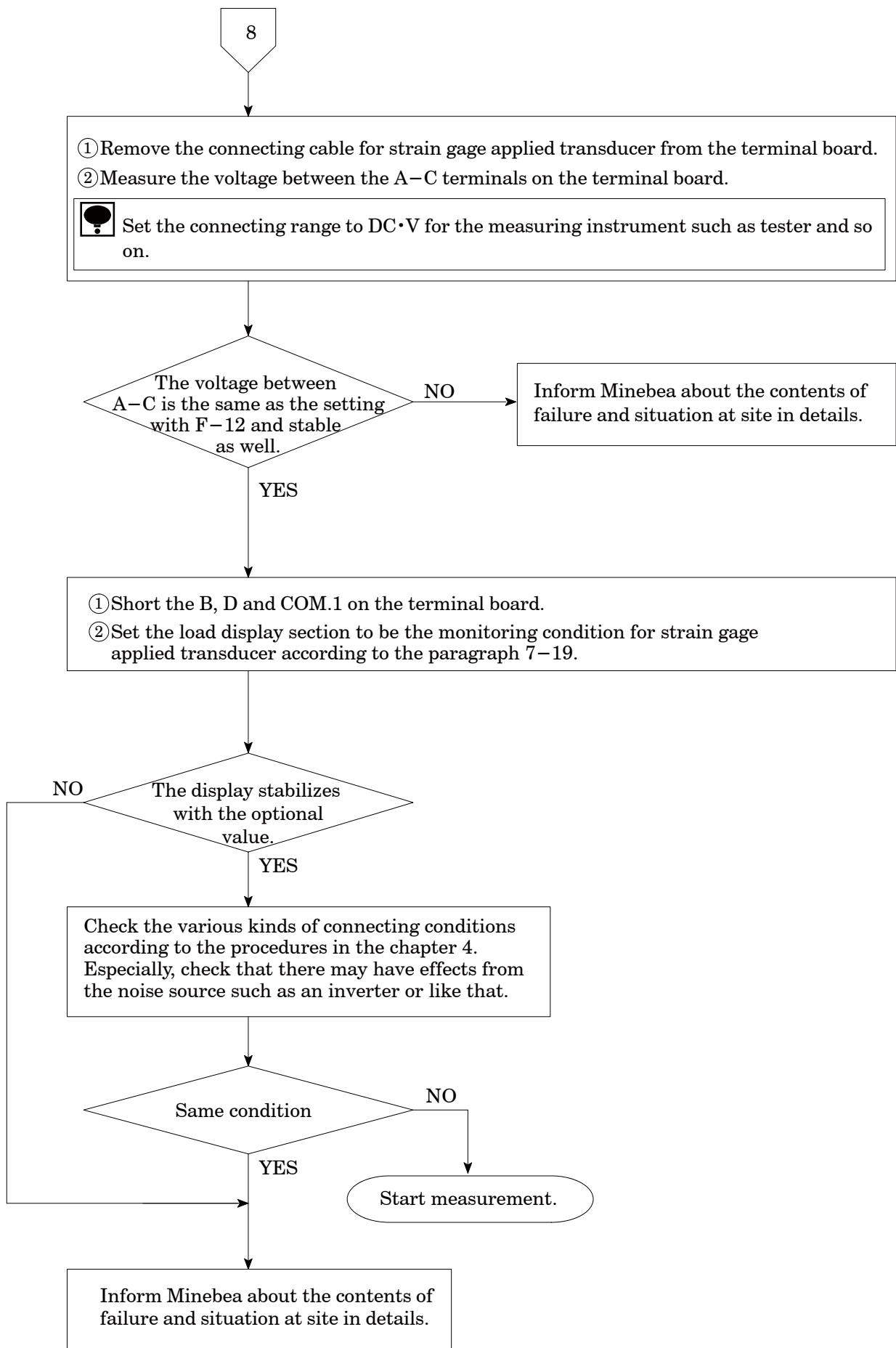

10-2.Optional check

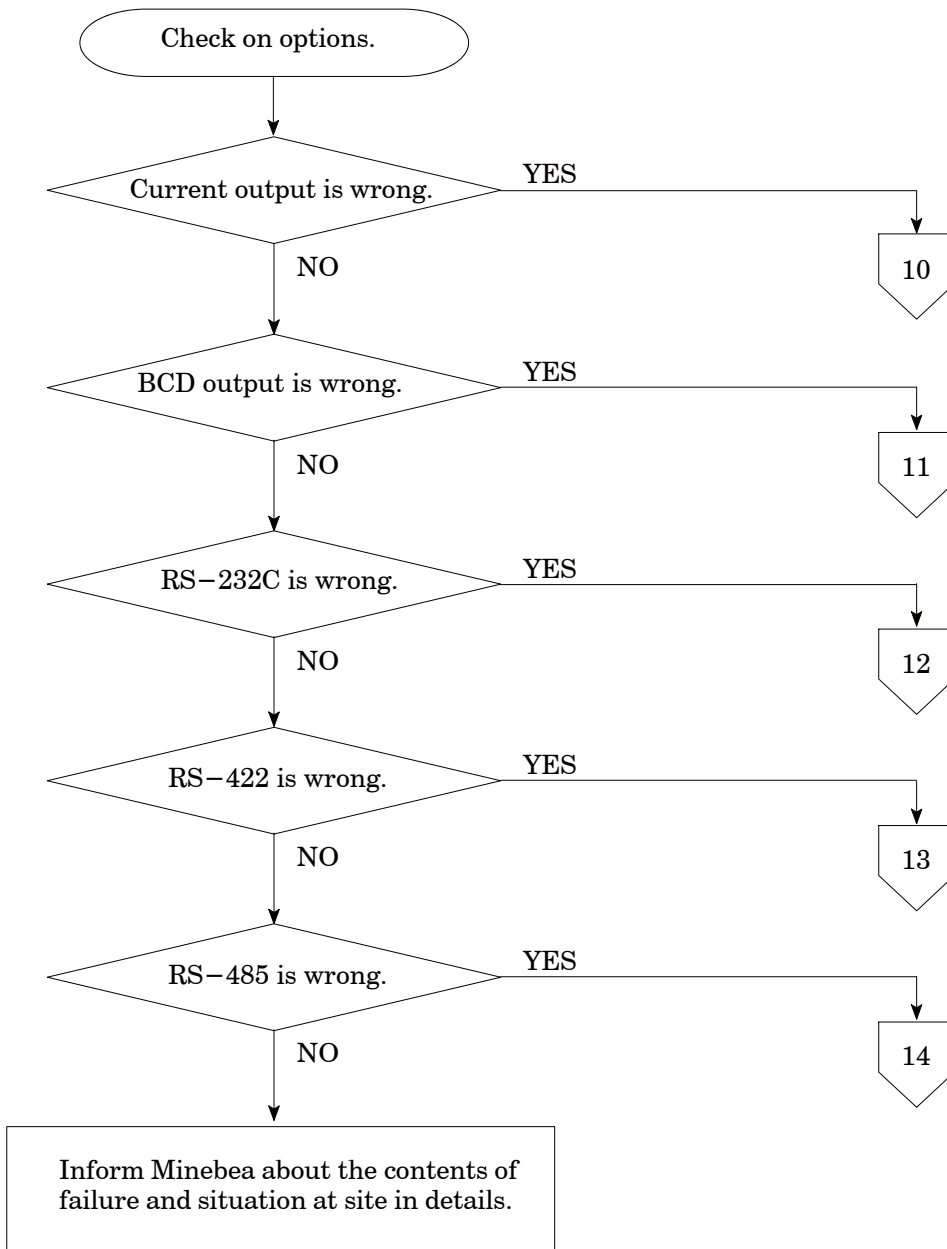

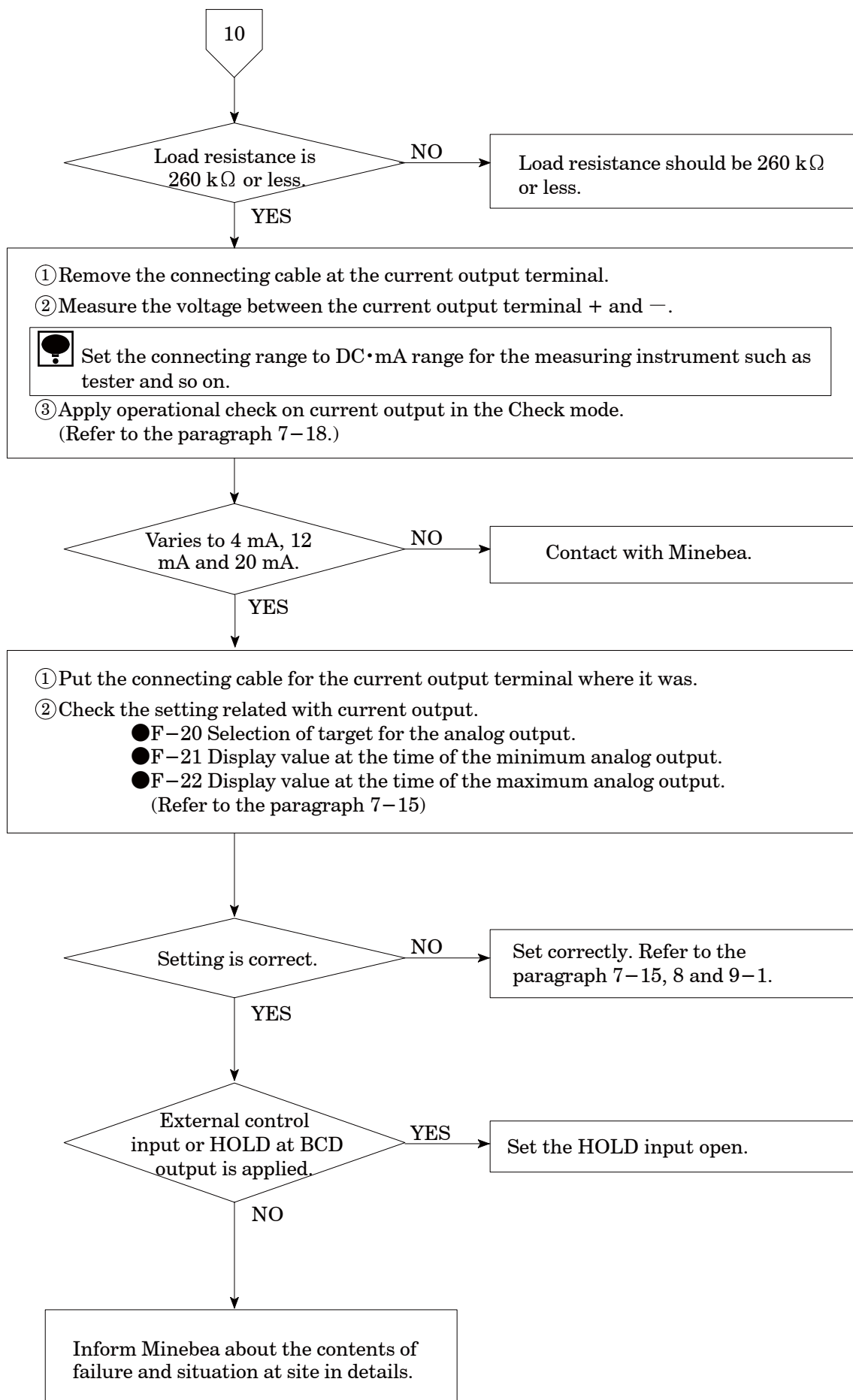

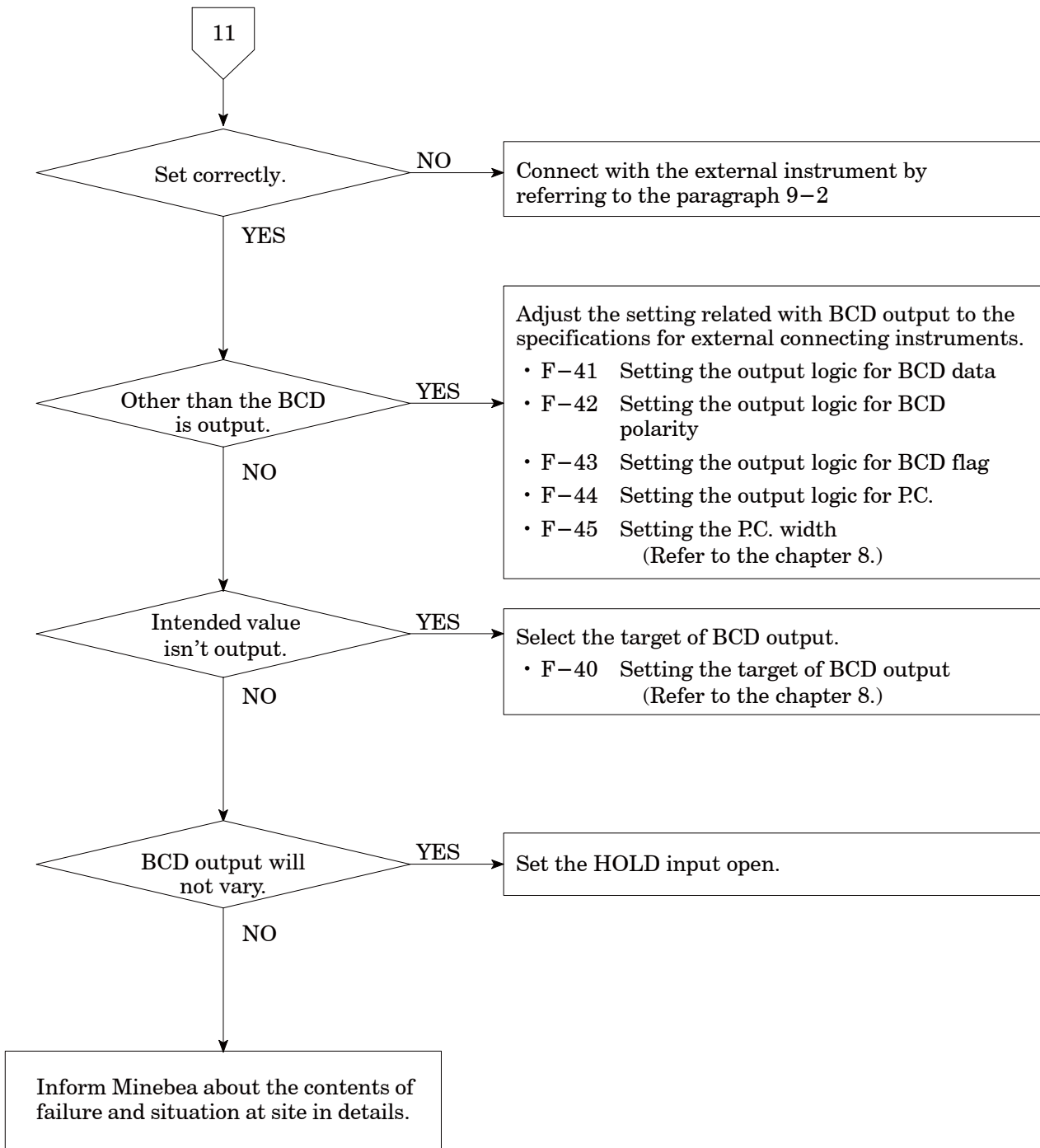

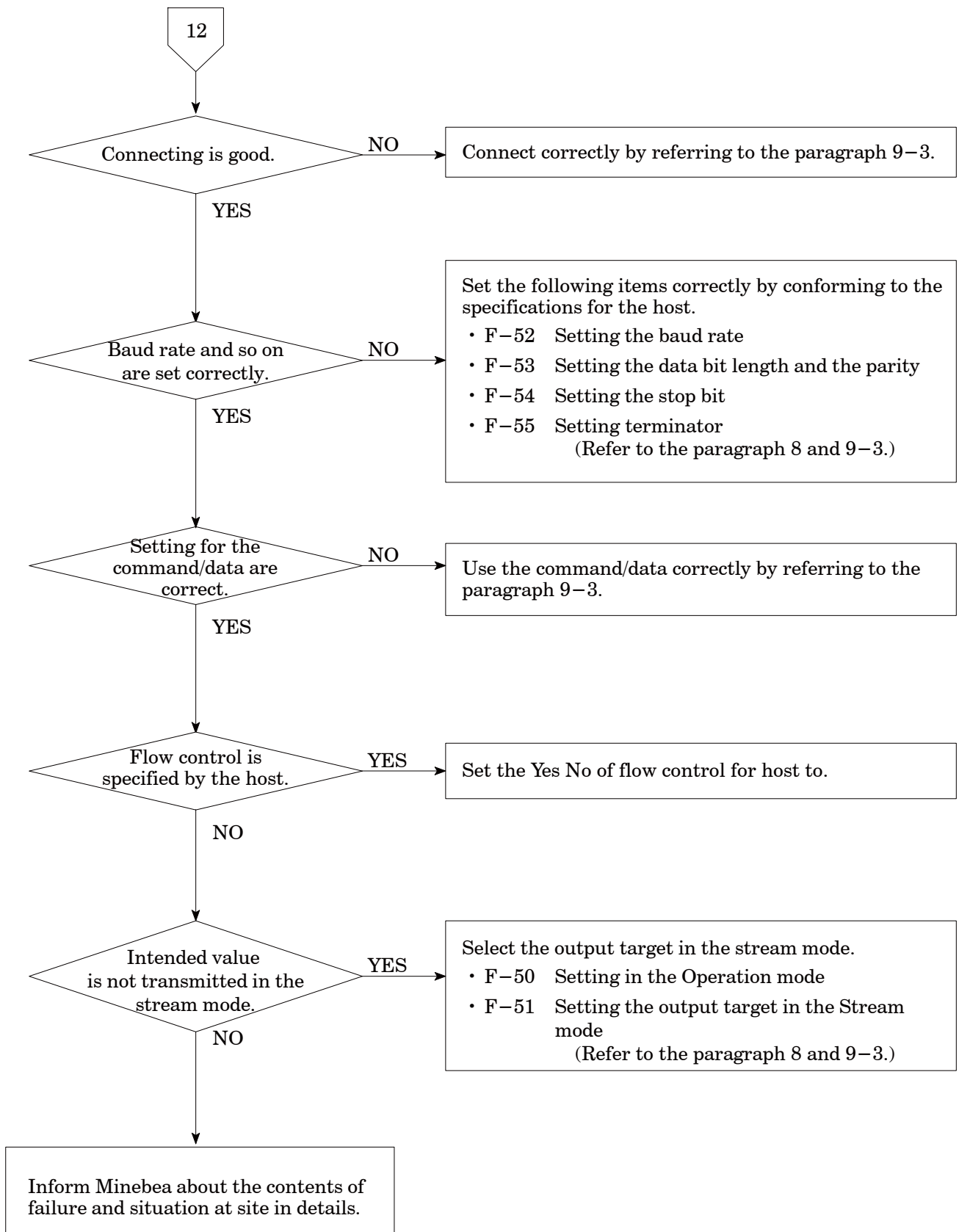

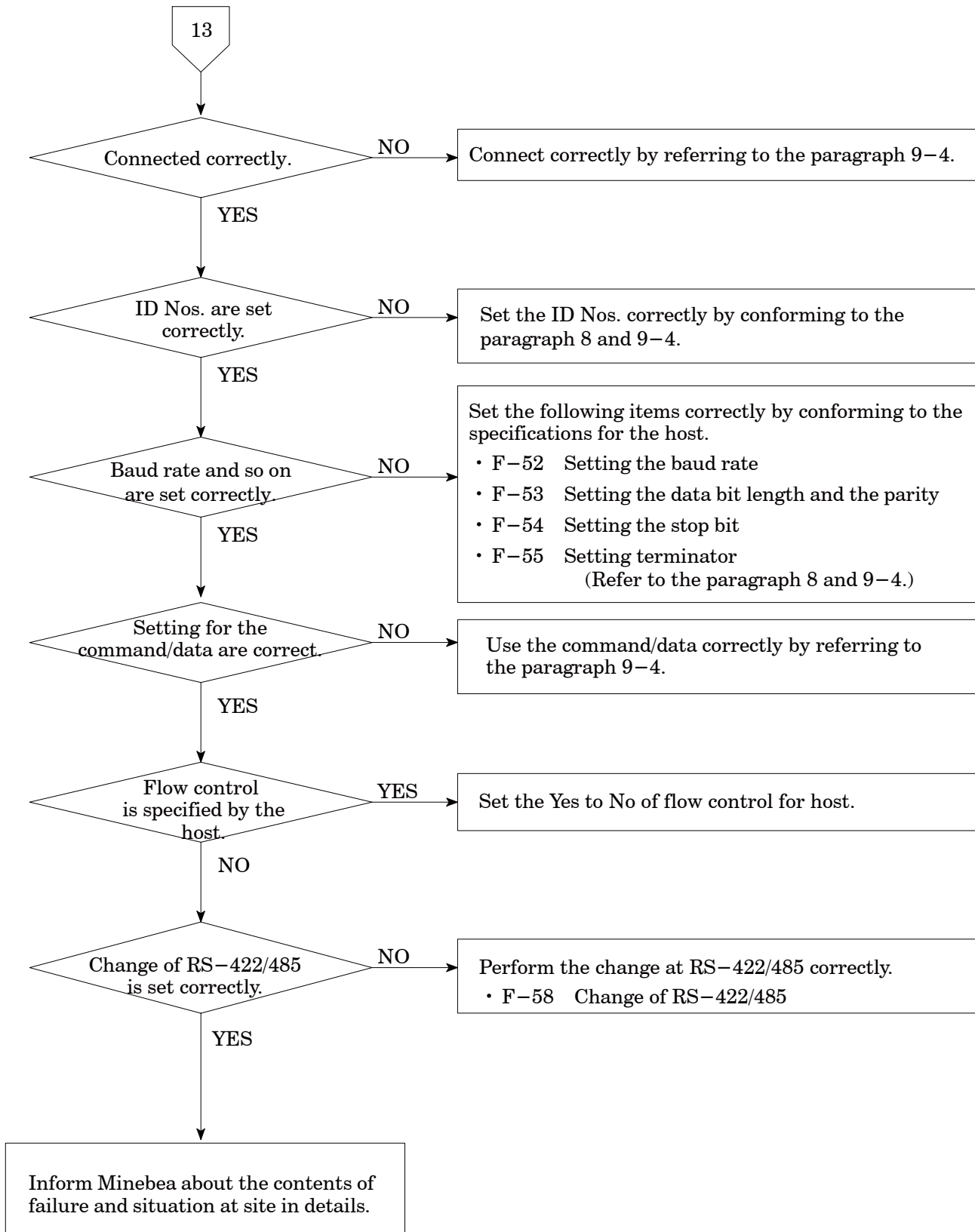

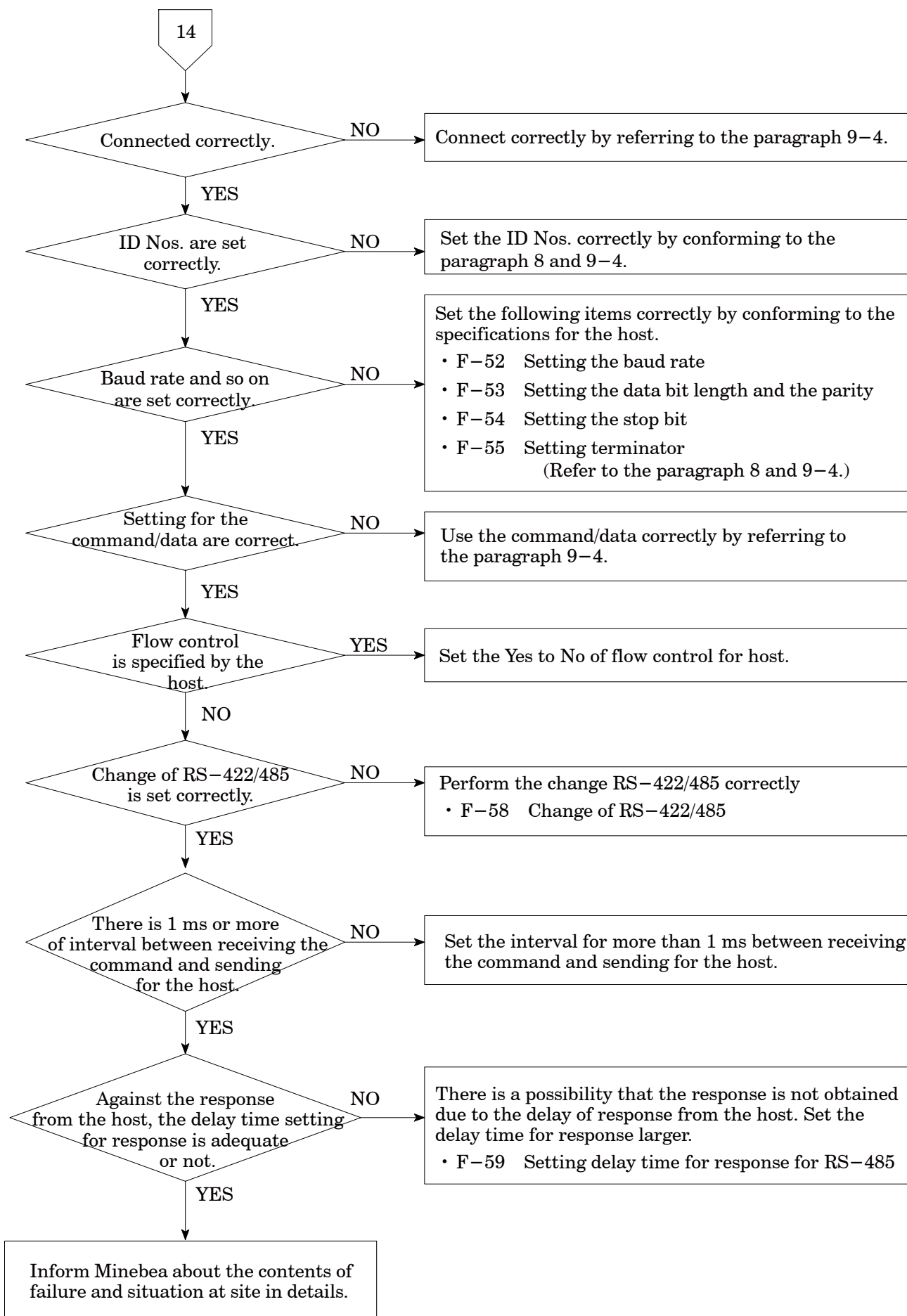

10-3. Error display

Error code	Contents of error	Remedy
ER-0	Zero set has executed with more than $\pm 10\%$ of the maximum display value.	Apply zero set after making it within $\pm 10\%$ of maximum display value.
	When CHECK is ON, zero setting is executed.	After CHECK is OFF, execute the zero setting.
ER-1	Setting mistake	Set correctly.
ER-2	Mistake in setting during calibration	Set correctly.
ER-3	A/D error	Turn off the power once and turn on it again. If the Error is still shown, contact with Minebea.
ER-4	Displays when the calibration(CCAL, ACAL, LCAL,TARE) is executed with the CHECK ON.	After setting the CHECK OFF, execute the calibration.
ER-5	At the time of fine adjustment on zero or span, it is shown when tare weight cancellation, zero set, and zero tracking and peak are ON. Displays while tare weight cancellation is ON when zero set is executed.	Set OFF while zero tracking is OFF. And set OFF while the peak is ON. Apply ZERO clear(F-98).
ER-6	When prohibiting the calibration is set, calibration or fine adjustment for analog is proceeded.	Remove the prohibition of calibration (F-97).
HOLD	Powered ON with the HOLD input is shorted.	Set the HOLD input open.
TE-L	Displays when the initial value at the time of calibration is less than -2.4 mV/V , or the total value with the initial load and the load equal to the maximum display value is less than -3.1 mV/V .	Adjust so that the initial load is within the range from -2.4 mV/V to 2.4 mV/V .
TE-H	Displays when the initial load is more than 2.4 mV/V , or the total value with the initial value and the load equal to the maximum display value exceeds 3.1 mV/V during calibration.	
SP-L	The value equal to the maximum display value at the time of calibration (LCAL) is less than 0.4 mV/V , or the difference between the initial value and the load equal to the maximum display value is less than 0.4 mV/V .	Adjust so that the value equal to the maximum display value is within the range from 0.4 mV/V to 3.1 mV/V .
SP-H	The value equal to the maximum display value at the time of calibration (LCAL) exceeds 3.1 mV/V , or the difference between the initial value and the load equal to the maximum display value exceeds 3.1 mV/V .	
ER-E	EEPROM error	Contact with Minebea.
ER-R	EEPROM error	
OL	Displays when 110% of the maximum display value is exceeded at the time of measurement or in calibration.	Set so that the load display will be within the range from -110% to 110% .
-OL	Displays when -110% of the maximum display value is exceeded at the time of measurement or in calibration.	
ER-W	RAM error	Contact with Minebea.

11. Specifications











11-1. Specifications for analog section

Bridge power supply	DC5 V \pm 0.25 V within 60 mA (Changeable to DC2.5 V)
Applicable transducers	Up to 4 pieces of strain gage applied transducers(350 Ω) can be connectable.
Input range	F.S. setting is available at the input range from \pm 0.4 mV/V to \pm 3.1 mV/V.(When bridge power supply is DC5 V)
Output range	DC \pm 10 V Load resistance is 5 k Ω or more. (F.S. setting is available in Function.)
Output times	Changeable to 4 times/s, 20 times/s, 50 times/s or 100 times/s (Synchronous with display rate.)
Output resolution	Approx.1/12 000
Zero adjustment range	\pm 2.4 mV/V
Non-linearity	
Display	0.01 %F.S.
Output	0.05 %F.S.
Temperature coefficient	
Zero point	\pm 0.5 μ V/ $^{\circ}$ C (Input conversion, When F.S. is set at the input from \pm 0.5 mV/V to \pm 3.1 mV/V)
Sensitivity	\pm 0.01 %F.S./ $^{\circ}$ C (Input conversion, When F.S. is set at the input from \pm 0.5 mV/V to \pm 3.1 mV/V)
Input noise	\pm 0.6 μ Vp-p or less (With the default setting of digital filter and stabilized filter)
Input filter	2 Hz (Changeable to 10 Hz, 100 Hz or 2kHz)
A/D sampling	100 times/s
CHECK	Approx.0.3 mV/V (Setting with the interval of about 0.1 mV/V is available in the range from approx.0.1 mV/V to 1.5 mV/V) ※The extension cable is applied to Minebea's standard cable CAB-502(4 cores) within the length of 30 m. ※Not applicable when the zener is used.
Analog peak hold	Response speed : Corresponds to the characteristics of input filter. Accuracy : 0.1 %F.S. or less





11-2. Specifications for digital section

Load display	
Display range	-99 999 to 99 999
Display increment	1 (Changeable to 2, 5 or 10)
Display	7 segment red LED, with 17 mm character's height
Over display	"-OL" displays at the time of minus(-) over, and "OL" displays at the time of plus (+) over.
Status display	SEL.1, SEL.2, \odot , HOLD, CHECK, PEAK, BOTTOM, A/Z
Judgement display	S0, S1, S2,
Display rate	4 times/s (Changeable to 20 times/s, 50 times/s or 100 times/s.)
Decimal point display	Changeable to non, 10^1 , 10^2 , 10^3 or 10^4 .

11-3. Front panel sheet key function

	Change of Function mode
	Zero set
	S1 set value display/Carry on set value / S0 set value display by pressing with the shift key together at the same time.
	S2 set value display/Increment of set value
	Change of Track with Peak hold, Bottom hold or Peak bottom hold, /Status display, Tare weight cancellation is executed when  lights on. (It can be changed by the function.)
	Reset of peak value During ON, the display is fixed to zero(0). /Status display, Tare weight cancellation clear is executed when  lights on (It can be changed by the function.)
	ON/OFF for check value
	Enter key/Shift key

11-4. External control function

ZERO	Same as  key ※Above is a pulse input. It is effective once after a input of a pulse width for 50 ms or more. (Pulse width is changeable to 5 ms, 10 ms or 20 ms.)
PEAK/TRACK/A/Z	Change of Track and or Peak hold, or Bottom hold and Peak bottom hold / Tare weight cancellation is executed when a status indicator of  lights on. (It is changed by the function.) Open : Track Short : Peak hold, Bottom hold, Peak bottom hold
HOLD	Hold of Display, Comparative output, BCD output and Analog output
RESET/A/Z OFF	Same as  key, reset condition is made by short. / Tare weight cancellation is executed when a status indicator of  lights on (It is changed by the function.)
SEL.1, SEL.2	4 kinds of "Calibration data" is changed by the combination of SEL.1 and SEL.2. Above is level input. It becomes effective while a input of shortening over 50 ms or more. Only the function of A/Z and A/Z OFF is a pulse input. These are effective once by a pulse width of 50 ms or more. (Level and pulse width is changeable to 5 ms, 10 ms or 20 ms.)

Equivalent circuit of external control input.

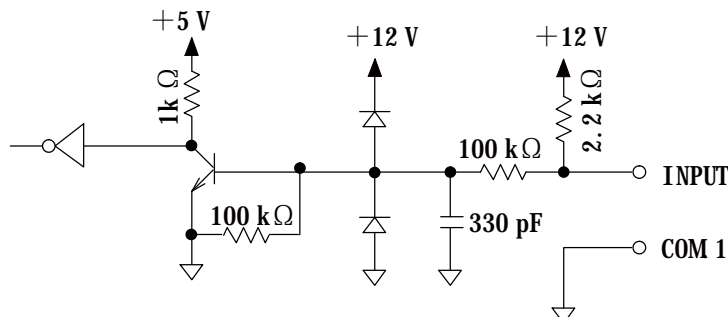

11-5. Comparator function

Set value	-99 999 to 99 999
Numbers of setting	3 points of S0, S1 and S2. ※“S0” is set by function.
Set value for hysteresis data	0 to 99 digits
Setting hysteresis time width	0 to 9.9 s
Hysteresis direction	Selectable from “On delay” or “Off delay”
Conversion times for comparator	Changeable to 4 times/s, 20 times/s, 50 times/s or 100 times/s. (Synchronous with display rate.) ※During the display of set value, both of the setting process and comparison process are interrupted.

11-6. Contact output signal

S1、S2	The contact operates when reached under/over the comparator set value.
S0	The contact operates with either condition in below by function setting. <ul style="list-style-type: none">• FULL condition (100 % of rated load).• When the both of S1 and S2 are OFF condition.• Operates when reached under/over the S0 set value. (Same as the comparative operation of S1 and S2.)• At the time of A/Z ON.• At the time of HOLD ON.• At the time of PEAK.
Contact specifications	1a contact AC125 V 0.1 A (Resistance load) DC30 V 0.5 A (Resistance load)

Equivalent circuit of contact output section

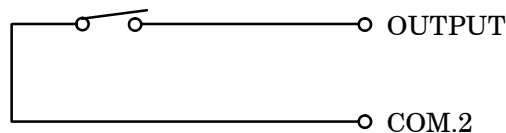

11-7. Various kinds of functions

Zero tracking	Stabilizes the variation of zero point within the fixed condition.
Digital filter	Stabilizes the data by the computing process through CPU.
Stabilized filter	Only when the load variation width is within the fixed value, this strengthens/stabilizes the digital filter.
Change of target of HOLD	With the combination of “Display”, “Comparative output”, “Analog output”, “BCD output(Option)”, target of HOLD can be made.
Sheet key lock	Prohibition of operation of optional key.
Selection of Peak mode	3 modes of Peak hold, Bottom hold and Peak bottom hold. Besides, the Peak hold can be selected from the two of “Digital peak hold” and “Analog peak hold”.
Change of target of analog output	The target of analog output can be changed either “TRACK value/Gross weight” and “Interlock of display”.

11–8.General specifications

Operating temperature/humidity range	
Temperature	–10 °C to 50 °C
Humidity	Less than 85 %RH (Non condensing.)
Power supply	
Power supply voltage	AC100 V to AC240 V (Allowable variable range AC85 V to AC264 V)
Power supply frequency	50/60 Hz
Power consumption	Approx. 9 VA (Without option, at AC100 V) Approx. 18 VA at max. (With option, at AC100 V to AC240 V)
Outline dimensions(W×H×D)	96 mm×96 mm×129.5 mm (Excludes protruding parts.)
Weight	Approx. 500 g (Without any options.)

11–9.Standard specifications at the shipment

Bridge power supply	DC5 V
Span adjustment	±2 000 display at the input of ±0.5 mV/V.
The minimum scale	1
Analog output	0 V to ±10. 000 V at 0 to ±2 000 display

11–10.Accessories

Instruction manual	1 piece
Time lug fuse	1 piece (1 A)
Unit seal	1 piece
Panel mounting attachment	2 pieces
Panel mounting gasket	1 piece
BCD output plug	1 piece(Attached only when optional BCD output is installed.)
CC–LINK plug	1 piece(Attached only when optional CC–LINK output is installed.)
CC–LINK Instruction manual	1 piece(Attached only when optional CC–LINK output is installed.)

11–11.Options

11–11–1. Current output



- P/N : CSD815B-P07
 - Specifications

Output	DC4 mA to 20 mA Load resistance at 260 Ω or less
Non–linearity	0.05 %F.S.
Resolution	Approx.1/12 000
Over range	“–OL” display at approx.DC2.4 mA and “OL” display at approx.DC21.6 mA.
- ※Voltage output is not available when this option is installed.

11-11-2. BCD output

• P/N : CSD815B-P15

• Specifications

- Output**
- BCD 5 digits Parallel output, with polarity(POL.) applied (Output ON with minus, and output OFF with plus.)
 - PC.(Print command)
ON for a fixed time after conversion of BCD output is completed.
 - ERROR ON at the time of various errors are occurred.
 - OVR(over)
Above are open collector outputs. $V_{CE} = DC30\text{ V}$, $I_C = DC20\text{ mA MAX}$
※Renewal of output cannot be made in other than the Measurement mode.
- Input**
- ZERO Same as the  key.
※Above pulse input and pulse width is 50 ms or more is effective once.
(Pulse width is changeable to 5 ms, 10 ms or 20 ms.)
 - PEAK/TRACK/A/Z Same as the  key
 - RESET/A/Z OFF Same as the  key
 - HOLD Hold of display and BCD output
 - BCD-ENABLE Compulsive OFF for the related output of BCD (Hi impedance)
※Above are level inputs, and effective by shortening 50 ms or more during inputting. Beside, only the functions of A/Z and A/Z OFF are pulse input and effective once after the input with pulse width at 50 ms or more.
(Level and pulse width : 5 ms, 10 ms or 20 ms changeable.)

11-11-3. CC-Link interface

• P/N CSD815B-P73

• Specifications

- Baud rate : Select from 156 kbps, 625 kbps, 2.5 Mbps, 5 Mbps or 10 Mbps
- Occupied stations No. : Selectable from 1,2 or 4 stations
- Communication method : Polling method
- Synchronous method : Bit synchronization method
- Symbolization method : NRZI
- Transmission path form : RS-485 bus
- Transmission format : HDLC conforming
- Remote station number : In the case of 1 station occupied, No's.01 to 64 can be selectable
In the case of 2 stations occupied, No's.01 to 63 can be selectable
In the case of 4 stations occupied, No's.01 to 61 can be selectable
- Error control method : CRC($X_{16} + X_{12} + X_5 + 1$)
- Connection cable : Twist pair cable with shield
- | | | |
|--------------------|-------|-------|
| Total cable length | 156 k | 1 200 |
| | 625 k | 600 |
| | 2.5 M | 200 |
| | 5 M | 150 |
| | 10 M | 100 |
- Connectable unit : In the case of 1 station occupied, 64 units at maximum
In the case of 2 stations occupied, 32 units at maximum
In the case of 4 stations occupied, 16 units at maximum
- Termination : Resistance attached externally
- Condition display LED : "RUN", "ERR", "SD", "RD"

11-11-4. RS-232C interface

- P/N : CSD815B-P74
- Specifications
 - Baud rate : Select from 1 200, 2 400, 4 800, 9 600, 19 200, or 38 400 bps.
 - Data bit length : Select from 7 bits or 8 bits.
 - Parity bit : Select from Non, Even or Odd.
 - Stop bit : Select from 1 bit or 2 bits.
 - Terminator : Select from CR+LF or CR.
 - Communication method : Half-duplex
 - Synchronous method : Start-stop synchronous method
 - Communication data : ASCII code

11-11-5. RS-422/485 interface

- P/N CSD815B-P76
- Specifications
 - Baud rate : Select from 1 200, 2 400, 4 800, 9 600, 19 200 or 38 400 bps.
 - Data bit length : Select from 7 bits and 8 bits.
 - Parity bit : Select from Non, Even or Odd.
 - Stop bit : Select from 1 bit or 2 bits.
 - Terminator : Select from CR+LF and CR.
 - Communication method : Half-duplex
 - Synchronous method : Start-stop synchronous method
 - Address : Select one among 0 to 31.
 - Communication data : ASCII code
 - Cable length : Approx. 1 km
 - No. of connections : 32 sets at max.(RS-422 : 10 sets)
 - Termination : Built-in (Yes/No can be selected by the connection with terminal board.) With input/output monitor LED.
 - Change of RS-422/485 : Can be set in Function.

11-12. Outline dimensions

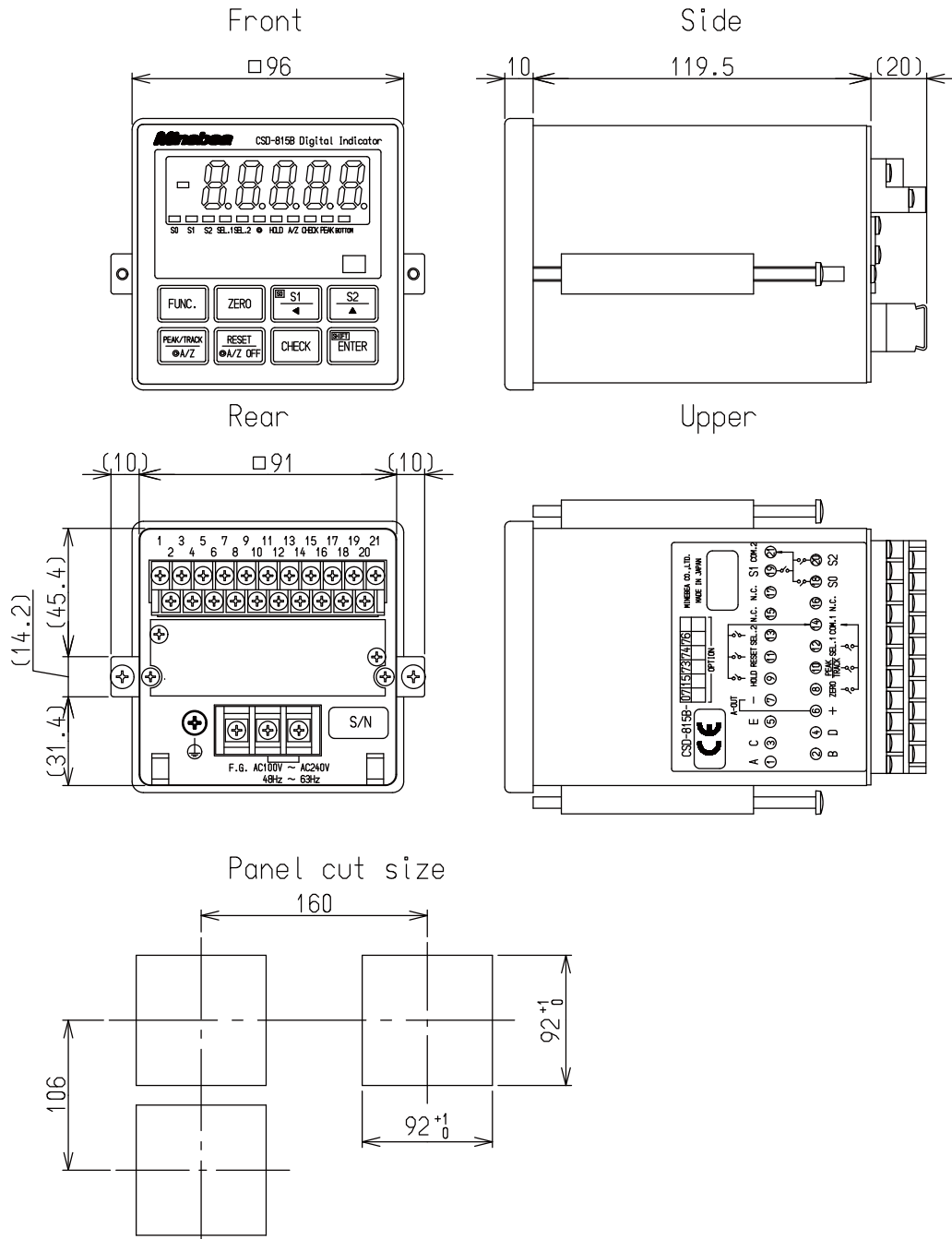

12. Warranty

12-1. Warranty

- The instrument is covered by a warranty for a period of one year from the date of delivery.
- As for repairs and/or after service is required during the period of warranty, contact with Minebea's sales office or sales agent from which you have purchased.

12-2. Repair

Before asking repairs, make checks once again that the connection, setting and adjustment for the instrument have finished properly by referring to 9. Trouble shooting.

Especially, make checks whether the connections of sensors are disconnected or cut off.

After that, still there may be found some defects in the instrument, contact with Minebea's sales office or sales agency from which you have purchased.

13. Appendix

13-1. Replacement of fuse



Warning ● When installation method for the fuse is wrong and/or the capacity of installed fuse is inadequate, it causes an unexpected fault of the instrument.

- ① Turn OFF the power supply for the instrument.
- ② Remove the 2 pieces of setscrews on the rear panel.
- ③ Holding the rear panel assembly, draw out it slowly to the arrow marked direction.

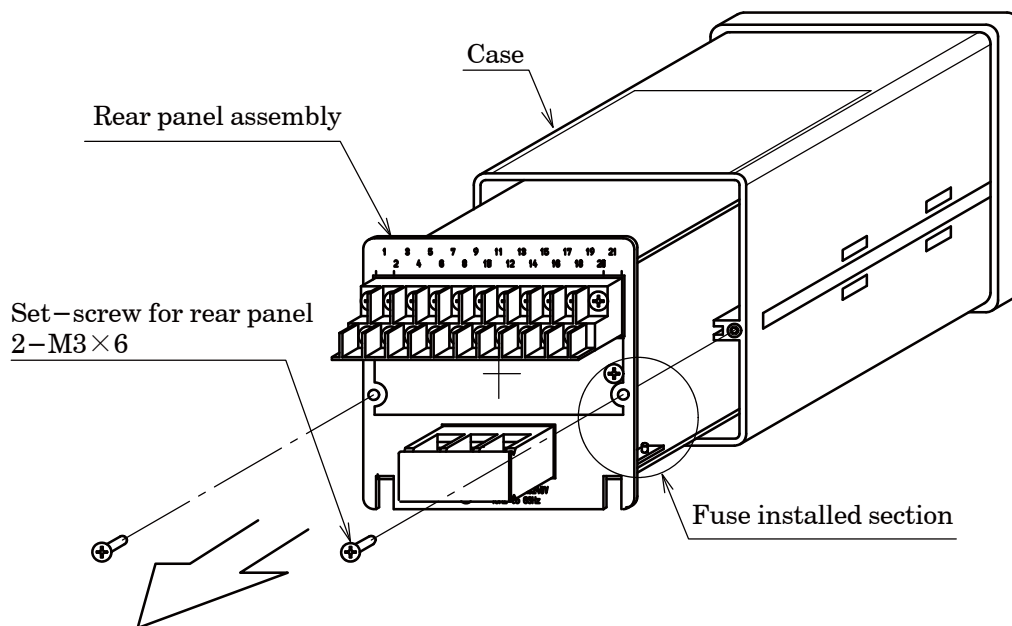

④ Replace the fuse installed on the POWER CARD.

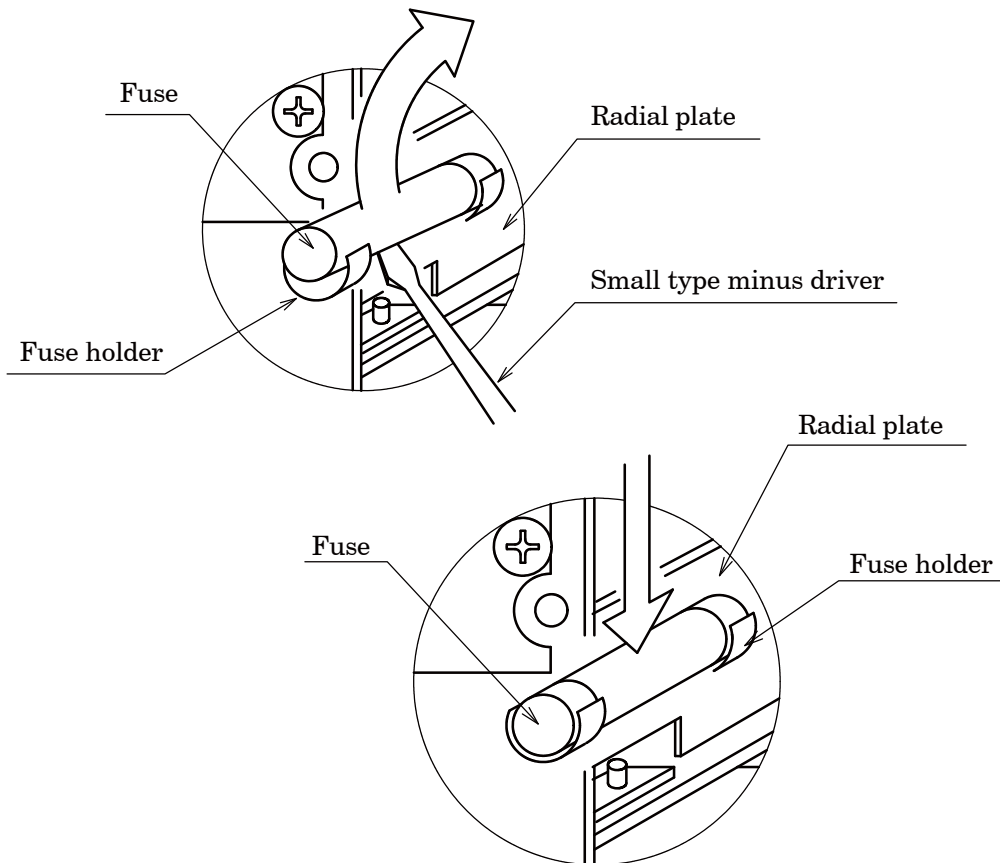

⑤ After replacing the fuse, install the rear panel assembly into the case.

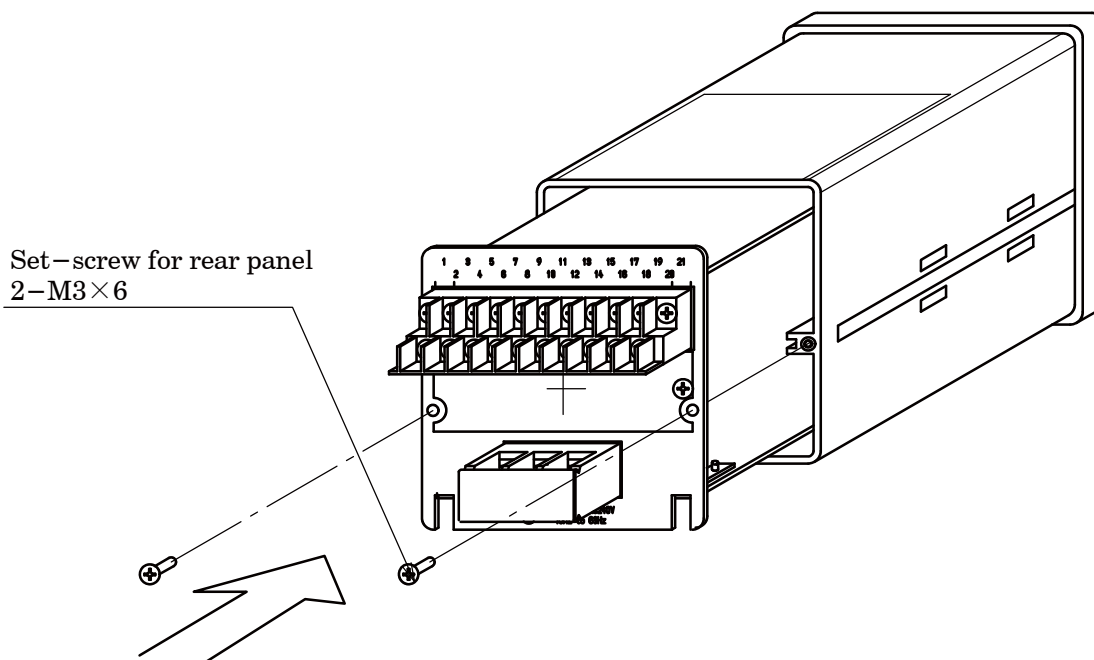

⑥ Set the 2 pieces of set-screws on the rear panel. Check that the rear panel and the case is attached closely.

Warning ● When the rear panel is not attached closely, you can't feel the click touch and also there may have the possibility that key operation is not made.

13-2.Character's pattern for display

The followings are the table to show the display pattern used at 7 segments display on the instrument.

0		D		Q	
1		E		R	
2		F		S	
3		G		T	
4		H		U	
5		I		V	
6		J		W	
7		K		X	
8		L		Y	
9		M		Z	
A		N		?	
B		O		!	
C		P		-	

13-3.Setting table for functions

※Make use of them in case that the customer has changed setting for the function.

Function No.	Initial value	Customer's setting	Function No.	Initial value	Customer's setting
F-01	00000		F-51	00000	
F-03	00000		F-52	00003	
F-04	00004		F-53	00021	
F-05	00000		F-54	00000	
F-06	00000		F-55	00001	
F-08	00000		F-56	00000	
F-09	00020		F-57	00000	
F-10	11111		F-58	00000	
F-11	00003		F-59	00005	
F-12	00000		F-60	00000	
F-15	00006		F-61	00000	
F-16	00020		F-70	00000	
F-17	00020		F-71	00001	
F-20	00000		F-72	00000	
F-21	00000		F-80	00000	
F-22	02000		F-81	00000	
F-30	00111		F-82	00000	
F-31	00000		F-84	00002	
F-32	00000		F-85	00001	
F-33	00000		F-86	00000	
F-34	00000		F-87	00000	
F-35	00000		F-88	—	
F-36	00000		F-89	—	
F-37	00000		F-90	—	
F-40	00000		F-91	—	
F-41	00000		F-92	—	
F-42	00000		F-93	—	
F-43	00000		F-94	—	
F-44	00000		F-97	00000	
F-45	00000		F-98	—	
F-50	00001		F-99	—	

Memo

- The contents of this manual may subject to change without notice.

HEAD QUARTER : **MINEBEA CO., LTD.**

4106-73 Miyota, Miyota-machi, Kitasakugun, Nagano-ken 389-0293, Japan

☎0267-32-2200 FAX.0267-31-1350

Measuring Components Business Unit

FUJISAWA PLANT 1-1-1, Katase, Fujisawa-shi Kanagawa-ken, 251-8531 Japan

☎0466-22-7152 FAX.0466-22-1701

KARUIZAWA PLANT 4106-73 Miyota, Miyota-machi, Kitasakugun, Nagano-ken 389-0293, Japan

☎0267-31-1309 FAX.0267-31-1350

HOME PAGE ADDRESS <http://www.minebea-mcd.com>