

# Air Preparation Products

651 Series | 652 Series | 653 Series

Filter Regulator Lubricator (FRL)

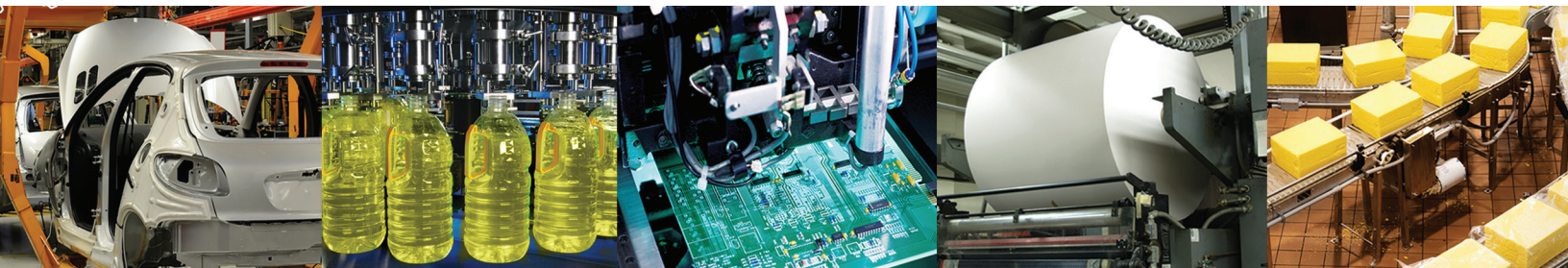

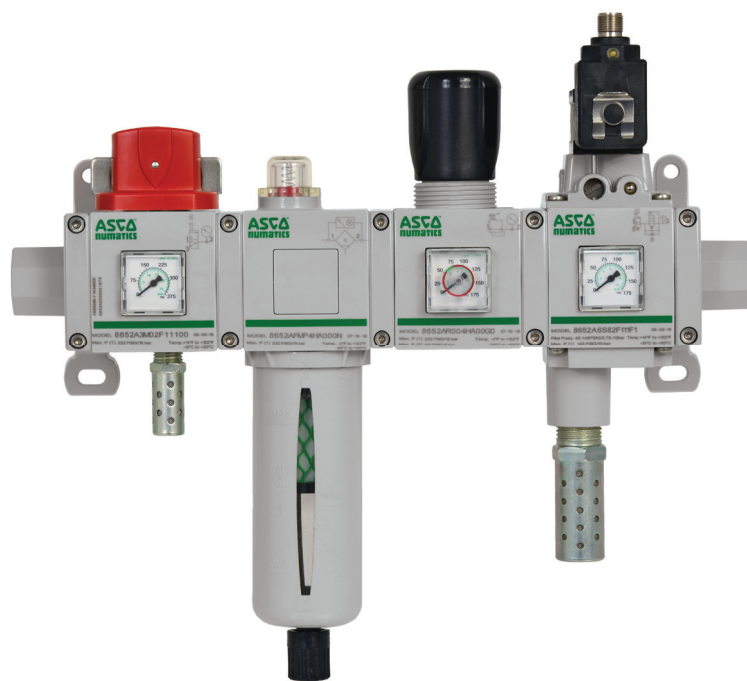

## 651/652/653 Series

Product Overview	2
Particulate Filter	4
Coalescing Filter	8
Adsorber - Activated Carbon	8
Regulator	12
Manifold Regulator	16
Particulate Filter/Regulator	19
Coalescing Filter/Regulator	23
Lubricator	27
Shut Off Isolation Valve	30
Slow Start/Quick Exhaust Valve	33
Diverter Block	36
Lockout Valve	38
Air Preparation Manifold Assemblies	40
Mounting Brackets	42
Bowl and Drain Options	43
280 Series Digital Pressure Switch	44
PS182 Series Pressure Switch	45
PS180 Series Pressure Switch	46
Digital Pressure Gauge	46
349 Series Pressure Switch	47
Electric Differential Pressure Indicator (DPI)	48
Electronic Liquid Level Indicator	48
Kits and Service Parts	49

**651/652/653 Series - Product Overview**

**Air Preparation Manifold Assembly  
& Optional Features**

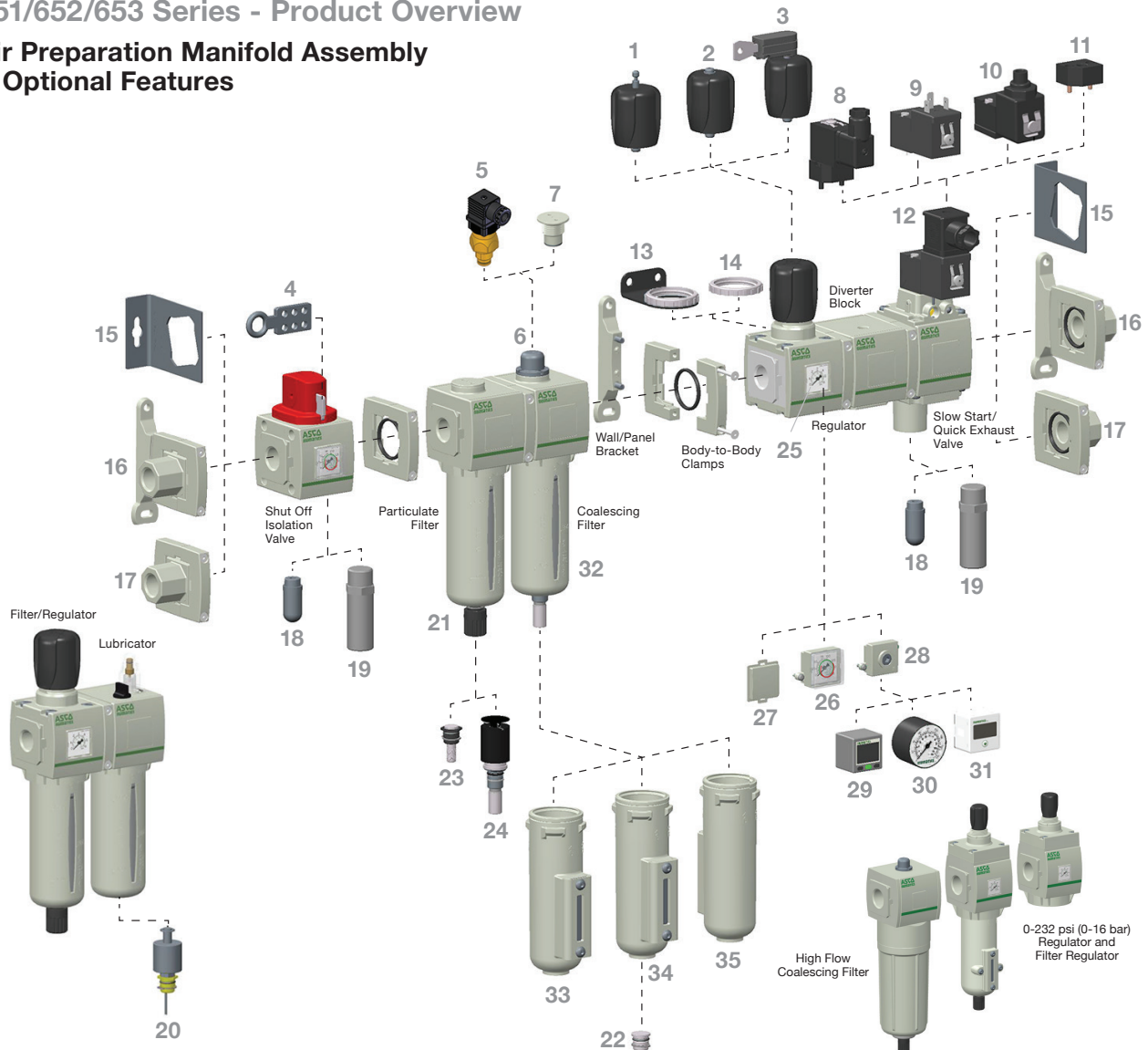

- |  |   |   |
|--|---|---|
| 1) Provision for Key Lockable (Regulator & F/R*)                     | & w/o LED)  | 25) Low Profile Gauge   |
| 2) Tamper Resistant (Regulator & F/R*)                               | 13) Panel Nut/Panel Bracket (Regulator & F/R*)            | 26) Low Profile Gauge with Pressure Range Indicators                    |
| 3) Key Lockable (Regulator & F/R*)                                   | 14) Panel Nut (Regulator & F/R)                           | 27) No Gauge Port   |
| 4) Scissor Lock  | 15) Side Mounting Brackets                                | 28) Port Plate  |
| 5) Electric Differential Pressure Indicator (Coalescing Filter)      | 16) End Plates, Body-to-Body Clamps & Wall/Panel Brackets | 29) Digital Pressure Switch - DPS 280 Series                            |
| 6) Differential Pressure Visual Pop-up Indicator (Coalescing Filter) | 17) End Plates & Body-to-Body Clamps                      | 30) Round Gauge   |
| 7) No Differential Pressure Indicator                                | 18) Polyethylene Muffler                                  | 31) Digital Gauge   |
| 8) Vertical Solenoid (DIN Connector with & w/o LED)                  | 19) Metal Muffler   | 32) Polycarbonate Bowl & Guard (No Bowl Guard Option - 651 Series Only) |
| 9) Horizontal Solenoid without DIN Spade Coil without Connector      | 20) Electronic Liquid Level Indicator                     | 33) Metal Bowl with Polyamide Sight Gauge                               |
| 10) Horizontal Solenoid with 3 Pin M12 Connection                    | 21) Semi-automatic/Manual Drain                           | 34) Metal Bowl with Borosilicate (Glass) Sight Gauge                    |
| 11) Pilot Air Operated   | 22) Plug for No Drain                                     | 35) Metal Bowl without Sight Gauge                                      |
| 12) Horizontal Solenoid (DIN Connector with                          | 23) Manual Drain - Stainless Steel                        |   |
| * F/R = Filter/Regulator   | 24) Automatic Drain - Normally Open - Brass               |   |

**651/652/653 Series Modular Assembly Mounting Features**

(see Accessories pages 52 & 53 for part numbers)

**Body-to-Body Assembly Clamp**

Easy to assemble Body-to-Body clamp, with captive screws. Available with NBR or FKM Seal. Products are easily assembled in seconds.



**End Plates with Body-to-Body Assembly Clamp**

The "End Plate" feature allows the user to easily remove the air prep assembly without having to remove the piping. Simply loosen the screws on the Body-to-Body assembly clamps, and the manifold is easily removed in seconds. The kit includes Inlet/Outlet plates, Body-to-Body clamps and O-Rings.

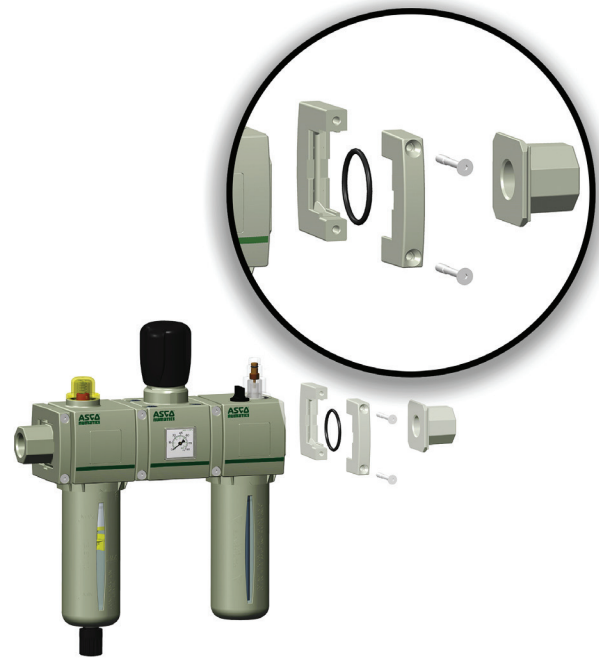

**Wall/Panel Bracket**

The Wall/Panel Bracket feature is the primary mounting feature for the air prep assemblies. These brackets easily attach to the back of the Body-to-Body assembly clamps using two screws. In addition, this bracket can be used as a support bracket in between any station on the manifold.



**Side Mounting Brackets**

The "Side Mounting Brackets" are typically used to mount single units, but could also be used to mount multiple units. Recommended only for static applications (without vibration).

NOTE: All ports are threaded as standard (except Lockout Valve).



**PARTICULATE FILTER**

- Large selection of filtering capacities to remove particulate and water droplets from compressed air or inert gas
- Sintered polyethylene elements, with centrifugal separator, include 5, 25 and 40 Microns
- Optional extended temperature range of -40 °F to 176 °F (-40 °C to 80 °C)
- Innovative two position plastic drain with manual and semi-automatic functions. Additional drains include an automatic style (brass) and manual (stainless steel)
- Polycarbonate and Aluminum bowls with a selection of sight gauge materials that meet industry and application requirements
- Threaded ports allow for individual or modular mounting
- Air purity class according to ISO 8573-1: 2010

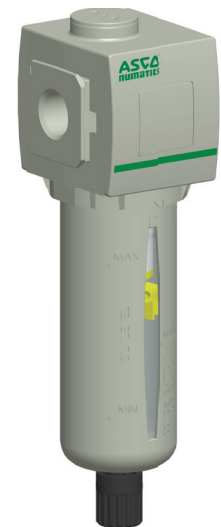

<b>Performance Data</b>						
<b>Series</b>		<b>651</b>	<b>652</b>	<b>653</b>		
Port Sizes		1/8, 1/4	1/4, 3/8, 1/2	1/2, 3/4, 1		
Thread Type		NPTF, G & Rc				
Nominal Flow - Per ISO 6358  P1 = 91.4 PSI (6.3 bar) ΔP = 14.5 PSI (1 bar)		Micron Rating		SCFM (L/min ANR)		
		1/8	5μ	31.2 (885)	-	-
			25μ	32.5 (920)	-	-
			40μ	34.6 (980)	-	-
		1/4	5μ	44.1 (1250)	70.8 (2020)	-
			25μ	49.6 (1410)	89.3 (2250)	-
			40μ	54.7 (1550)	92.4 (2640)	-
		3/8	5μ	-	76.5 (2190)	-
			25μ	-	118.7 (3390)	-
			40μ	-	135.5 (3870)	-
		1/2	5μ	-	80.2 (2290)	136.0 (3850)
			25μ	-	129.5 (3700)	162.4 (4600)
			40μ	-	153.0 (4370)	196.0 (5550)
		3/4	5μ	-	-	141.3 (4000)
			25μ	-	-	166.0 (4700)
			40μ	-	-	229.5 (6500)
1	5μ	-	-	150.1 (4250)		
	25μ	-	-	176.6 (5000)		
	40μ	-	-	245.4 (6950)		
Maximum Inlet Pressure PSIG (bar)		Polycarbonate Bowl	232 (16)	174 (12)		
		Aluminum Bowl	232 (16)	290 (20)		
Ambient Temperature Range °F (°C)		-4 to 122 (-20 to 50)				
Fluid Temperature Range °F (°C)		-4 to 122 (-20 to 50)				
Fluid		Air or Inert Gas				
Weight lbs. (kg)		w/Polycarbonate Bowl	0.52 (0.238)	0.94 (0.426)	2.06 (0.934)	
		w/Aluminum Bowl	0.84 (0.382)	1.22 (0.553)	2.51 (1.140)	

<b>Materials in Contact with Fluid</b>	
Body	Aluminum
Seals	NBR/FKM
Filter Element	Sintered Polyethylene
Bowl	Polycarbonate or Aluminum

<b>Air Purity Class - ISO 8573-1:2010</b>	
5μ	(5:8:4)
25μ	(6:8:4)
40μ	(7:8:4)

How to Order - Particulate Filter

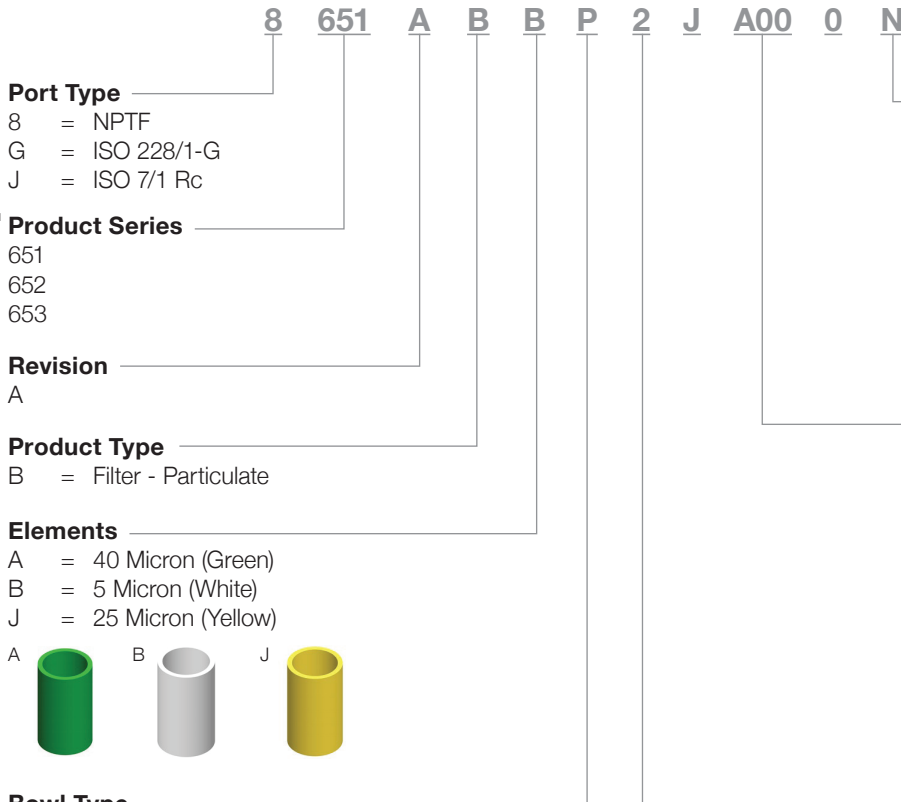

**Port Type**  
 8 = NPTF  
 G = ISO 228/1-G  
 J = ISO 7/1 Rc

**Product Series**  
 651  
 652  
 653

**Revision**  
 A

**Product Type**  
 B = Filter - Particulate

**Elements**  
 A = 40 Micron (Green)  
 B = 5 Micron (White)  
 J = 25 Micron (Yellow)

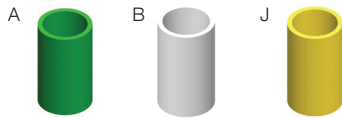

**Bowl Type**  
 K = Metal Bowl without Sight Gauge  
 L = Metal Bowl with Sight Gauge (Glass)  
 M = Metal Bowl with Sight Gauge (Polyamide)  
 N = Polycarbonate Bowl without Bowl Guard (651 only)  
 P = Polycarbonate Bowl with Bowl Guard



**Drain Type**  
 0 = No Drain  
 A = Auto Drain Normally Open  
 N = Manual - Semi-automatic Drain  
 Q = Manual Drain - Stainless Steel



**Options**  
 A00 = No Options  
 101 = Side Mounting Brackets  
 105 = High Temperature (80 °C/176 °F)  
 106 = Low Temperature (-40 °C/-40 °F)  
 109 = FKM Seals  
 117 = ATEX Zones 1-21   
 202 = 105 + 109  
 2A9 = 105 + 106

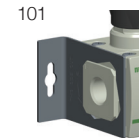

**Port Size**  
 1 = 1/8 (651 Series)  
 2 = 1/4 (651 or 652 Series)  
 3 = 3/8 (652 Series)  
 4 = 1/2 (652 or 653 Series)  
 5 = 3/4 (653 Series)  
 6 = 1 (653 Series)

1 Conforms to ISO standards 1179-1  
 2 If multiple options are required, please use the online CAD configurator on the website to generate the part number ([www.asco.com](http://www.asco.com)), or consult factory  
 3 Compressed air must be dry enough so no ice formation is present on the product. All bowls should be emptied prior to ambient temperatures dropping below 32 °F (0 °C)

**Dimensions: mm (inches) 651/652/653 Series Particulate Filter**

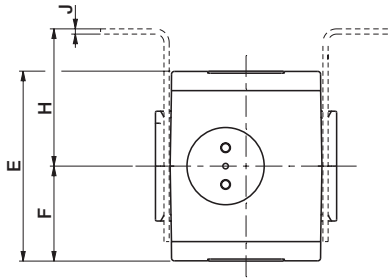

**651/652 Series**

**653 Series**

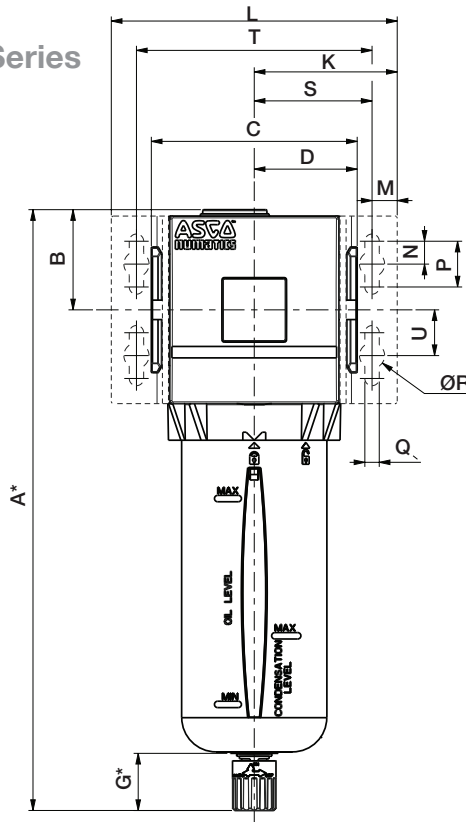
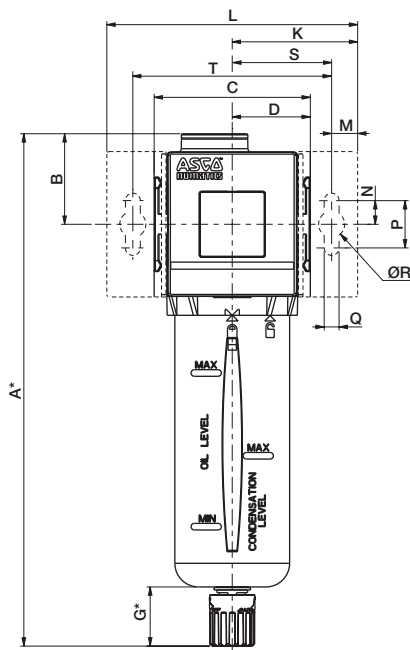

**Cross Section -  
651/652/653 Series  
Particulate Filter**

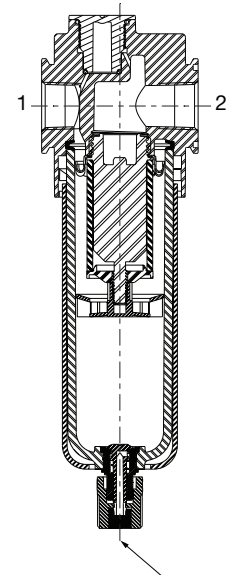

To remove bowl allow:  
651 - 44mm (1.8in)  
652 - 75mm (3.0in)  
653 - 100mm (4.0in)  
from the bottom of  
the bowl drain

	A*	B	C	D	E	F	G*	H	J
<b>651</b>	197	33.8	50	25	58	29	25	44.5	1.27
	(7.76)	(1.33)	(1.97)	(0.98)	(2.28)	(1.14)	(0.98)	(1.75)	(0.05)
<b>652</b>	217	38.3	66	33	69	34.5	25	50	1.9
	(8.54)	(1.51)	(2.60)	(1.30)	(2.72)	(1.36)	(0.98)	(1.97)	(0.07)
<b>653</b>	260.7	43.8	90	45	93.2	46.6	25	62	3
	(10.26)	(1.72)	(3.54)	(1.77)	(3.67)	(1.83)	(0.98)	(2.44)	(0.11)

	K	L	M	N	P	Q	ØR	S	T	U
<b>651</b>	46	92	11	10	20	6.3	11	35	70	-
	(1.81)	(3.62)	(0.43)	(0.39)	(0.79)	(0.25)	(0.43)	(1.38)	(2.76)	-
<b>652</b>	53	106	11	10	20	6.3	11	42	84	-
	(2.09)	(4.17)	(0.43)	(0.39)	(0.79)	(0.25)	(0.43)	(1.65)	(3.31)	-
<b>653</b>	62.5	125	11	10	20	6.3	11	51.5	103	20
	(2.46)	(4.92)	(0.43)	(0.39)	(0.79)	(0.25)	(0.43)	(2.03)	(4.06)	(0.79)

\* Variable dimension based on type of drain that is specified; if an Automatic Drain is specified, add another 5mm to G dimension, which also adds 5mm to the A dimension.



Particulate Filter Flow Charts

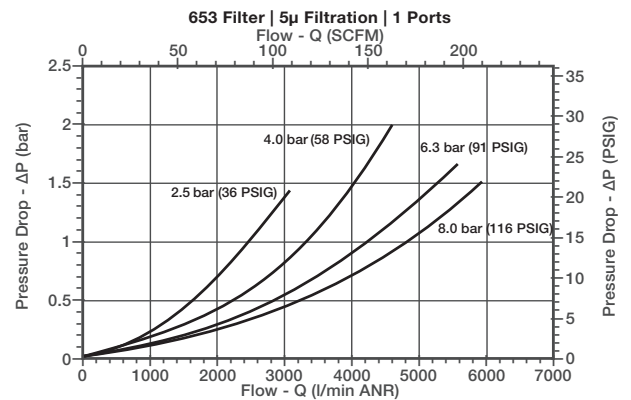
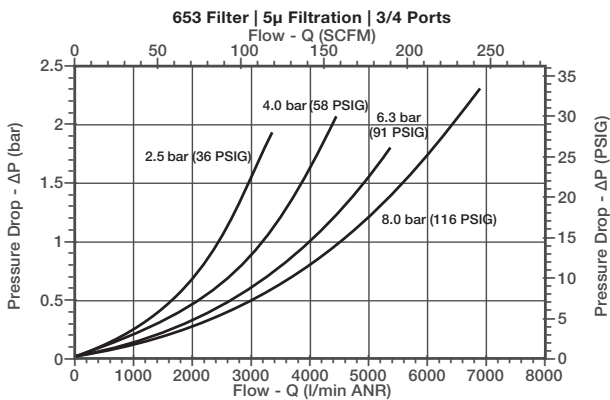
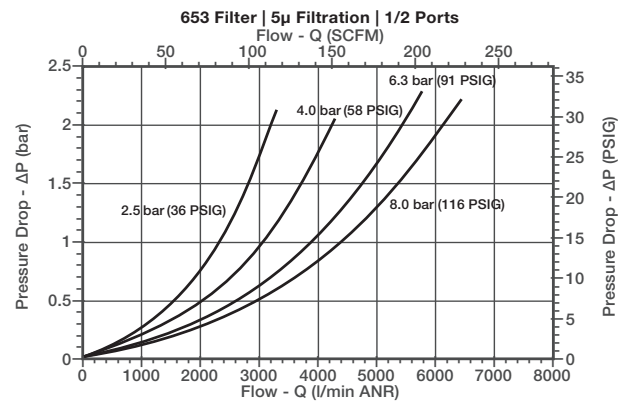
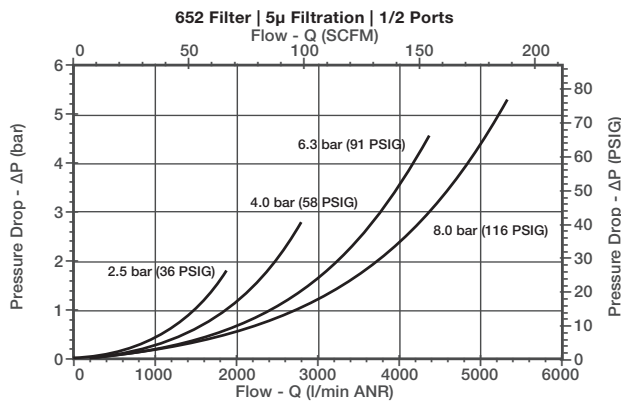
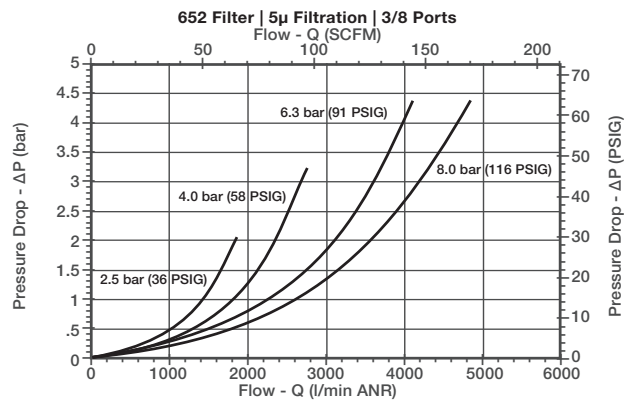
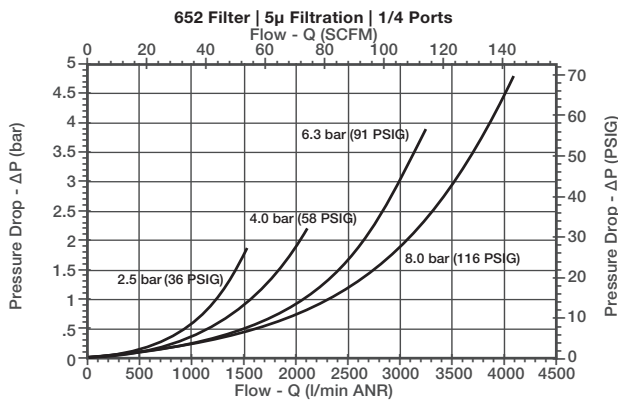
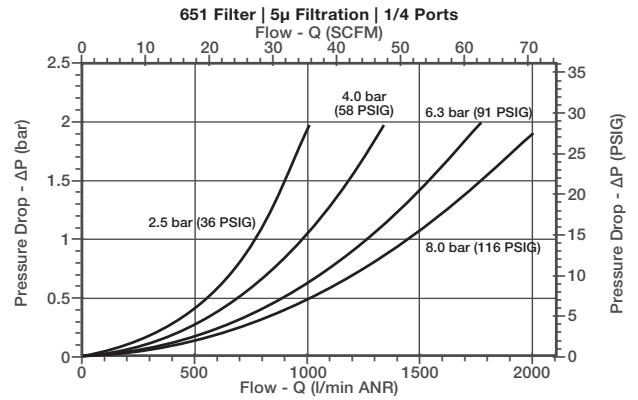
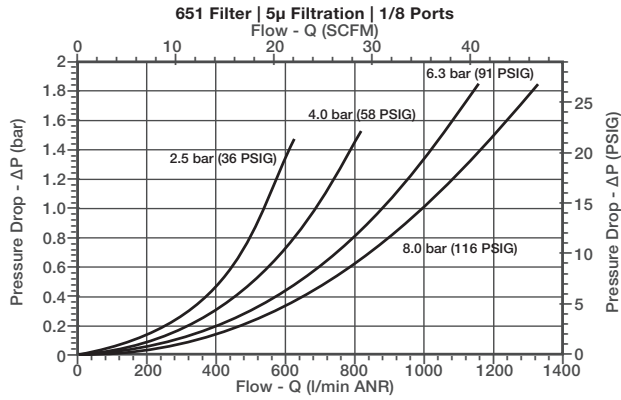

**COALESCING FILTER & ADSORBER**

- Extensive range of coalescing filter elements to remove oil and sub-micron particles down to 0.01 microns. Air purity class according to ISO 8573-1: 2010
- Optional 3 micron pre-filter integrated in the coalescing element eliminates the need for a separate particulate element. Coalescing filter elements include 0.3 and 0.01 microns
- Adsorber filter (activated carbon) for removal of odors and hydrocarbon vapor
- 653 High Flow Coalescer optimizes overall 653 manifold flow; use transition adapters to step up from 651 to 652 or 652 to 653 filters when needed
- Polycarbonate and Aluminum bowls with a selection of sight gauge materials that meet industry and application requirements
- Optional extended temperature range of 176 °F (80 °C)
- Visual or electrical differential pressure Indicators for condition monitoring of filter element

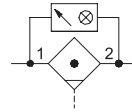

651/652/653

653 High Flow

Performance Data								
Series	651		652		653		653 High Flow	
Port Sizes	1/8, 1/4		1/4, 3/8, 1/2		1/2, 3/4, 1		1	
Thread Type	NPTF, G & Rc							
Nominal Flow - Per ISO 6358 P1 = 91.4 PSI (6.3 bar) ΔP = 5 PSI (0.35 bar)	1/8	Micron Rating	SCFM (L/min ANR)					
		0.3 μm	15.3 (430)	-	-	-		
	1/4	0.01 μm	10.9 (310)	-	-	-		
		0.3 μm	17.0 (480)	28.0 (800)	-	-		
	3/8	0.01 μm	12.4 (350)	25.0 (710)	-	-		
		0.3 μm	-	28.6 (820)	-	-		
	1/2	0.01 μm	-	27.5 (790)	-	-		
		0.3 μm	-	30.5 (870)	81.2 (2300)	-		
	3/4	0.01 μm	-	29.1 (830)	63.6 (1800)	-		
		0.3 μm	-	-	90.0 (2550)	-		
	1	0.01 μm	-	-	67.1 (1900)	-		
		0.3 μm	-	-	91.8 (2600)	291.3 (8250)		
Maximum Inlet Pressure PSIG (bar)	Polycarbonate Bowl	232 (16)		174 (12)	-			
	Aluminum Bowl	232 (16)		290 (20)				
Ambient Temperature Range °F (°C)	35 to 122 (1.7 to 50)							
Fluid Temperature Range °F (°C)	35 to 122 (1.7 to 50)							
Fluid	Air or Inert Gas							
Weight lbs. (kg)	w/Polycarbonate Bowl	0.54 (0.245)	0.98 (0.442)	3.18 (1.442)	N/A			
	w/Aluminum Bowl	0.86 (0.390)	1.25 (0.569)	2.72 (1.234)	4.03 (1.828)			

Materials in Contact with Fluid	
Body	Aluminum
Seals	NBR/FKM
Coalescing Filter Element	Borosilicate Microfiber & Polyester
Filter Element End Cap	Polypropylene
Adsorber	Activated Carbon
Bowl	Polycarbonate or Aluminum

Air Purity Class - ISO 8573-1:2010*	
0.3 μm	(3:7:3)
0.01 μm	(2:7:2)

\* 651 Series maximum flow at 91.4 PSI (6.3 bar) inlet pressure to maintain air purity class is 3.5 SCFM (100 L/min)  
 \* 652 Series maximum flow at 91.4 PSI (6.3 bar) inlet pressure to maintain air purity class is 10.6 SCFM (303 L/min)  
 \* 653 Series maximum flow at 91.4 PSI (6.3 bar) inlet pressure to maintain air purity class is 25.0 SCFM (707 L/min)  
 \* 653 Series - High Flow maximum flow at 91.4 PSI (6.3 bar) inlet pressure to maintain air purity class is 58.0 SCFM (1,641 L/min)

How to Order - Coalescing Filter

8 651 A F D P 2 H A00 0 N

**Port Type**

8 = NPTF  
<sup>1</sup>G = ISO 228/1-G  
 J = ISO 7/1 Rc

**Product Series**

651  
 652  
 653

**Revision**

A

**Product Type**

A = Adsorber - Activated Carbon (All Series)  
 F = Filter - Coalescing (All Series)  
<sup>2</sup>H = High Flow Version (653 Series Filter only, Coalescing or Adsorber)

A/F      H



**Elements**

D = 0.3 Micron - Coalescer (Green)  
 E = 0.01 Micron - Coalescer (Red)  
 F = Adsorber - Activated Carbon (Gray)  
 M = 0.3 Micron Coalescer with 3 Micron Prefilter (Green)  
 N = 0.01 Micron Coalescer with 3 Micron Prefilter (Red)

D/M      E/N      F



**Bowl Type**

K = Metal Bowl without Sight Gauge  
 L = Metal Bowl with Sight Gauge (Glass)  
 M = Metal Bowl with Sight Gauge (Polyamide)  
 N = Polycarbonate Bowl without Bowl Guard (651 only)  
 P = Polycarbonate Bowl with Bowl Guard

K (High Flow)    K/L/M      N      P



**Drain Type**

0 = No Drain  
 A = Auto Drain Normally Open  
 N = Manual - Semi-automatic Drain  
 Q = Manual Drain - Stainless Steel

A      N      Q



**Options**

A00 = No Options  
 101 = Side Mounting Brackets  
 105 = High Temperature (80 °C/176 °F)  
 109 = FKM Seals  
 117 = ATEX Zones 1-21   
 202 = 105 + 109

101



**Indication Type**

E = Electric Differential Pressure Indicator  
 H = Differential Pressure Visual Pop-up Indicator  
 J = No Differential Pressure Indicator

E      H

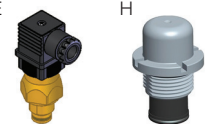

**Port Size**

1 = 1/8 (651 Series)  
 2 = 1/4 (651 or 652 Series)  
 3 = 3/8 (652 Series)  
 4 = 1/2 (652 or 653 Series)  
 5 = 3/4 (653 Series)  
 6 = 1 (653 Series)

1 Conforms to ISO standards 1179-1  
 2 Only available in 1" Port Size and with Metal Bowl without Sight Gauge  
 3 If multiple options are required, please use the online CAD configurator on the website to generate the part number ([www.asco.com](http://www.asco.com)), or consult factory

**Dimensions: mm (inches) 651/652/653 Series Coalescing Filter and Adsorber**

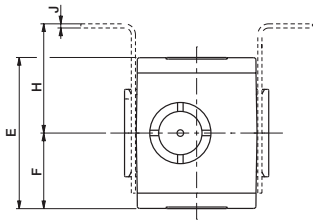

**651/652 Series**

**653 Series**

**653 Series High Flow**

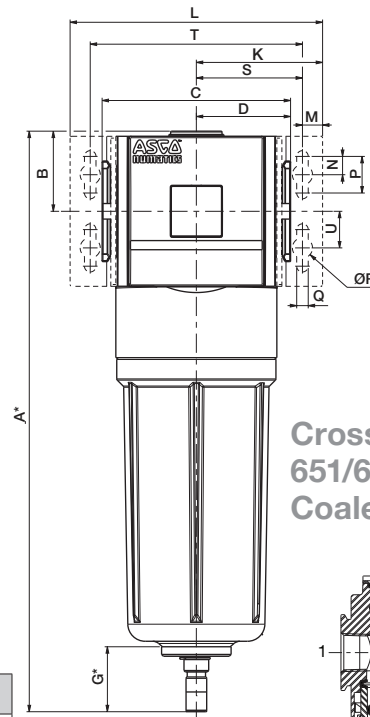
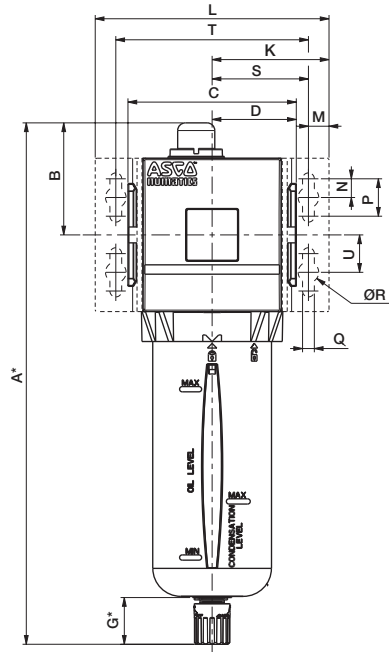
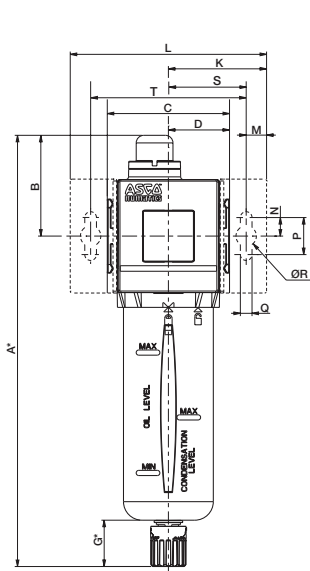

**Cross Section -  
651/652/653 Series  
Coalescing Filter**

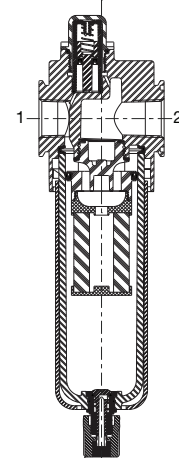

	A*	B	C	D	E	F	G*	H	J
<b>651</b>	213	50	50	25	58	29	25	44.5	1.27
	(8.39)	(1.97)	(1.97)	(0.98)	(2.28)	(1.14)	(0.98)	(1.75)	(0.05)
<b>652</b>	233	54.4	66	33	69	34.5	25	50	1.9
	(9.17)	(2.14)	(2.60)	(1.30)	(2.72)	(1.36)	(0.98)	(1.97)	(0.07)
<b>653</b>	276.8	59.9	90	45	93.2	46.6	25	62	3
	(10.90)	(2.36)	(3.54)	(1.77)	(3.67)	(1.83)	(0.98)	(2.44)	(0.12)
<b>653 High Flow</b>	317.3	43.8	103	51.5	93.2	46.6	35.5	62	3
	(12.49)	(1.72)	(4.06)	(2.03)	(3.67)	(1.83)	(1.40)	(2.44)	(0.12)

	K	L	M	N	P	Q	ØR	S	T	U
<b>651</b>	46	92	11	10	20	6.3	11	35	70	-
	(1.81)	(3.62)	(0.43)	(0.39)	(0.79)	(0.25)	(0.43)	(1.38)	(2.76)	-
<b>652</b>	53	106	11	10	20	6.3	11	42	84	-
	(2.09)	(4.17)	(0.43)	(0.39)	(0.79)	(0.25)	(0.43)	(1.65)	(3.31)	-
<b>653</b>	62.5	125	11	10	20	6.3	11	51.5	103	20
	(2.46)	(4.92)	(0.43)	(0.39)	(0.79)	(0.25)	(0.43)	(2.03)	(4.06)	(0.79)
<b>653 High Flow</b>	69	138	11	10	20	6.3	11	58	116	20
	(2.72)	(5.43)	(0.43)	(0.39)	(0.79)	(0.25)	(0.43)	(2.28)	(4.57)	(0.79)

To remove bowl allow:  
 651 - 60mm (2.4in)  
 652 - 80mm (3.2in)  
 653 - 105mm (4.2in)  
 653 High Flow - 125mm (4.9in)  
 from the bottom of  
 the bowl drain

\* Variable dimension based on type of drain that is specified; if an Automatic Drain is specified, add another 5mm to G dimension, which also adds 5mm to the A dimension.

Coalescing Filter and Adsorber Flow Charts

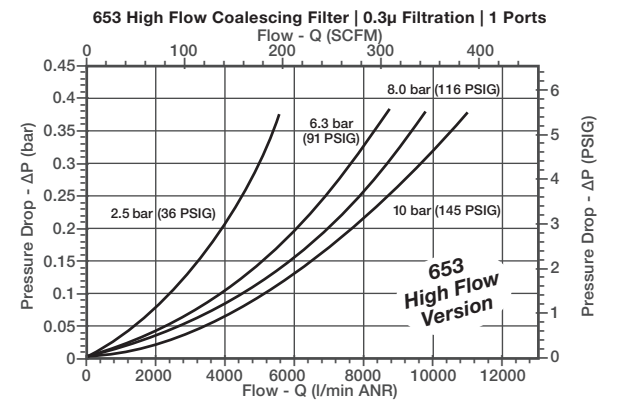
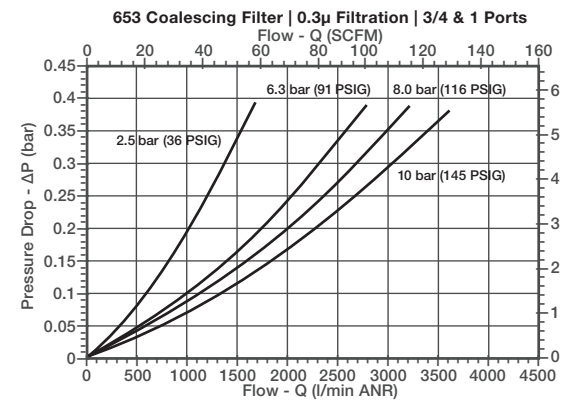
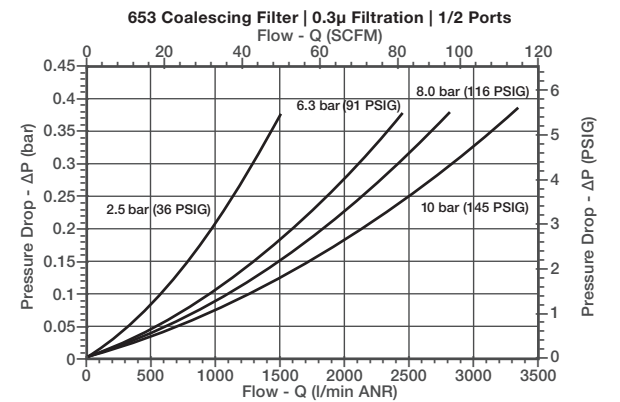
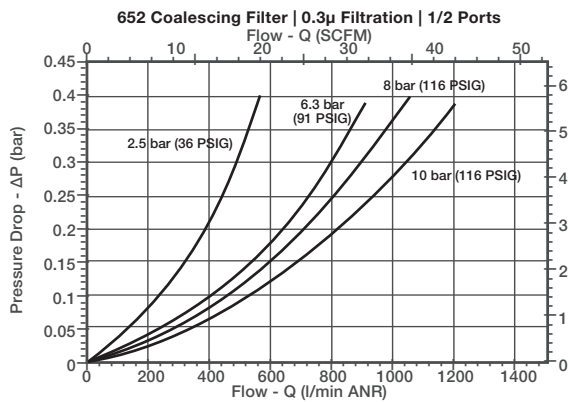
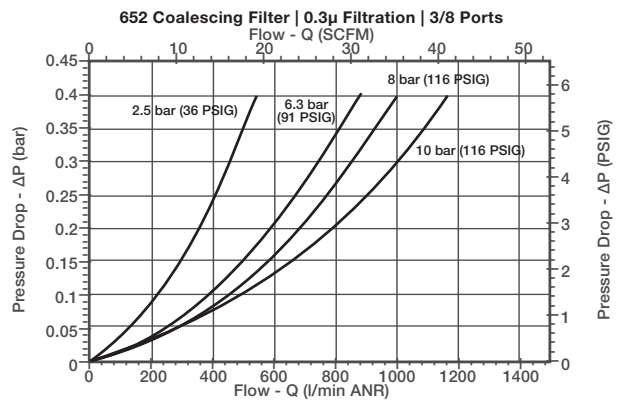
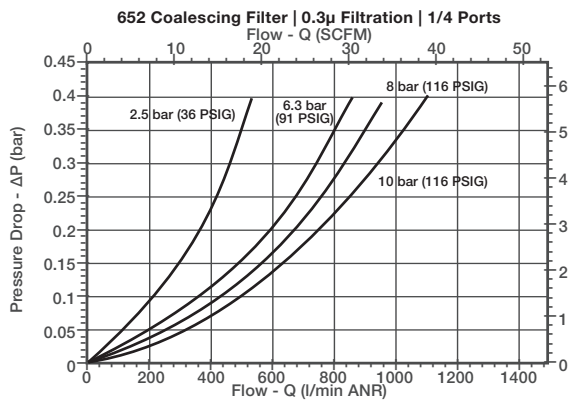
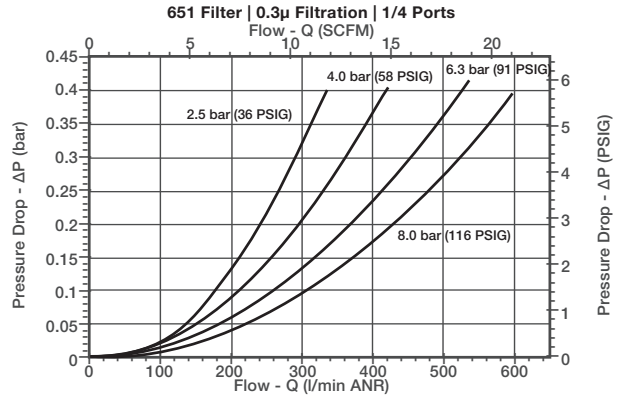
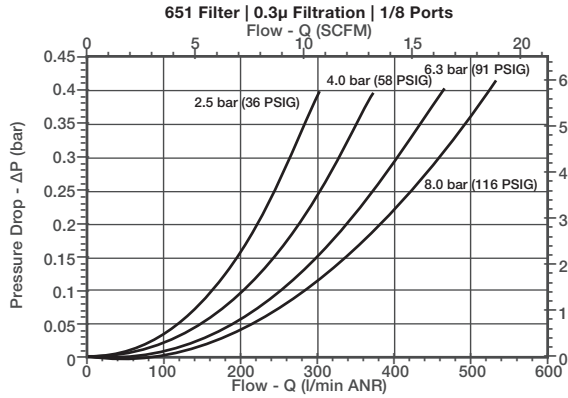

**REGULATOR**

- High flow with a wide range of adjustable output pressure ranges
- Available with relieving, non-relieving and internal flow check options
- Optional low profile gauge, round gauge, digital gauge or digital pressure switch
- Optional extended temperature range of -40 °F to 176 °F (-40 °C to 80 °C)
- Threaded ports allow for individual or modular mounting
- Key lockable and tamper resistant options

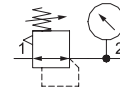

Performance Data				
Series	651	652	653	
Port Size	1/8, 1/4	1/4, 3/8, 1/2	1/2, 3/4, 1	
Thread Type	NPTF, G & Rc			
Nominal Flow - Per ISO 6358  P1 = 145 PSI (10 bar) Setpoint P2 = 91.4 PSI (6.3 bar) ΔP = 14.5 PSI (1 bar)	SCFM (L/min ANR)			
	1/8	28.1 (800)	-	-
	1/4	72.6 (2060)	144.2 (4120)	-
	3/8	-	228.6 (6530)	-
	1/2	-	245.0 (7000)	245.0 (7000)
	3/4	-	-	353.1 (10000)
	1	-	-	406.1 (11500)
Maximum Inlet Pressure PSIG (bar) P1	232 (16)		290 (20)	
Adjustable Pressure Ranges PSIG (bar) P2	3 to 45 (0.2 to 3)			
	3 to 60 (0.2 to 4)			
	7 to 125 (0.5 to 8)			
	7 to 145 (0.5 to 10)			
	-	-	7 to 232 (0.5 to 16)*	
Pilot Operated Regulator Input-to-Output Pressure Ratio	-	1:1	-	
Ambient Temperature Range °F (°C)	-4 to 122 (-20 to 50)			
Fluid Temperature Range °F (°C)	-4 to 122 (-20 to 50)			
Fluid	Air or Inert Gas			
Weight lbs. (kg)	0.47 (0.215)	0.95 (0.431)	2.43 (1.102)/2.85 (1.293)*	

\* High pressure assisted version

Materials in Contact with Fluid	
Body	Aluminum
Seals	NBR/FKM
Springs	Stainless Steel
Poppet	Brass
Stem	PA

## How to Order - Regulator

8 651 A R 0 0 2 F A00 G 0

**Port Type**

- 8 = NPTF
- <sup>1</sup>G = ISO 228/1-G
- J = ISO 7/1 Rc

**Product Series**

- 651
- 652
- 653

**Revision**

- A

**Product Type**

- K = Regulator with Internal Flow Check (652 only)
- <sup>2</sup>R = Regulator
- W = Pilot Operated Regulator (652 only)

K/R      W



**Port Size**

- 1 = 1/8 (651 Series)
- 2 = 1/4 (651 or 652 Series)
- 3 = 3/8 (652 Series)
- 4 = 1/2 (652 or 653 Series)
- 5 = 3/4 (653 Series)
- 6 = 1 (653 Series)

**Pressure Range**

- D = 3–45 PSIG/0.2–3 bar
- E = 3–60 PSIG/0.2–4 bar
- G = 7–125 PSIG/0.5–8 bar
- H = 7–145 PSIG/0.5–10 bar
- N = 7–232 PSIG/0.5–16 bar (653 only)\*

**Options**

- A00 = No Options
- 101 = Side Mounting Brackets
- 102 = Panel Nut (651 and 652 only)
- 103 = Tamper Resistant
- 104 = Key Lockable
- 105 = High Temperature (80 °C/176 °F)
- <sup>4</sup>106 = Low Temperature (-40 °C/-40 °F)
- 109 = FKM Seals
- 113 = Stainless Steel Fasteners
- 114 = Provision for Key Lockable Option
- 117 = ATEX Zones 1–21 
- 119 = Panel Bracket with Panel Nut (651 and 652 only)
- 121 = Non-relieving (Not available on Pilot Operated Regulator)
- 122 = Bottom Oriented Pressure Adjustment
- 123 = Gauge Type Mounted for Right-to-Left Flow
- 202 = 105 + 109
- 2A9 = 105 + 106

**Gauge Type**

- B = Digital Pressure Switch - PNP
- C = Digital Pressure Switch - NPN
- D = Digital Gauge
- F = Low Profile Gauge PSI/bar
- G = Low Profile Gauge bar/PSI
- H = Low Profile Gauge PSI/bar with Pressure Range Indicator
- J = Low Profile Gauge bar/PSI with Pressure Range Indicator
- N = No Gauge with Port Plate (1/8 NPTF)
- P = No Gauge with Port Plate (1/8 ISO 7/1 Rc)
- Q = Round Gauge bar/PSI
- R = Round Gauge PSI/bar
- 0 = No Gauge Port

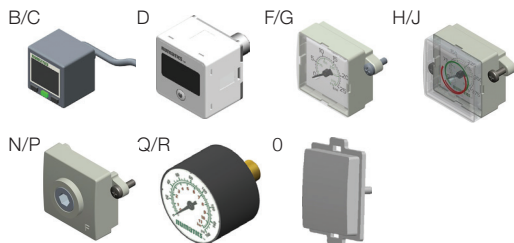

- 1 Conforms to ISO standards 1179-1
- 2 Relieving Standard; use option 121 for Non-relieving
- 3 If multiple options are required, please use the online CAD configurator on the website to generate the part number ([www.asco.com](http://www.asco.com)), or consult factory
- 4 Compressed air must be dry enough so no ice formation is present on the product

**Dimensions: mm (inches) 651/652/653 Series Regulator**

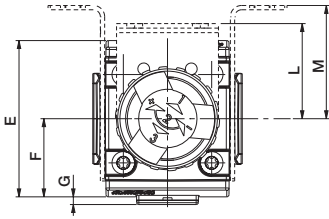

**651/652 Series**

**653 Series**

**653 Series High Pressure Regulator 232 PSIG (16 bar)**

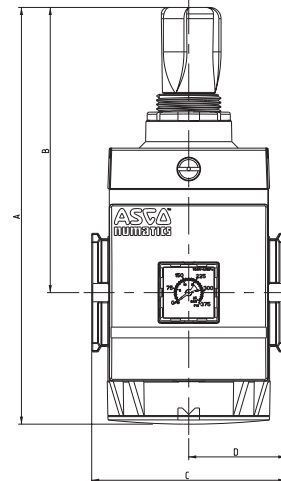
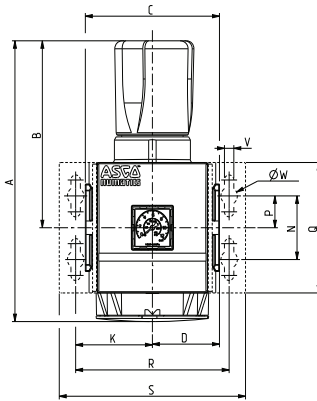
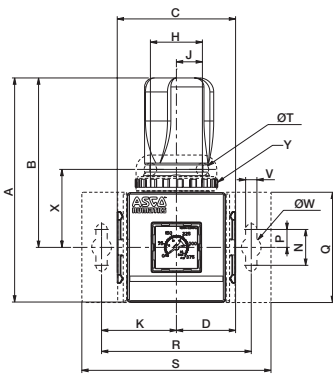

	A	B	C	D	E	F	G	H	J	K	L	M
<b>651</b>	103 (4.06)	77.5 (3.05)	50 (1.97)	25 (0.98)	58 (2.28)	29 (1.14)	3.4 (0.13)	29 (1.14)	14.5 (0.57)	35 (1.38)	42 (1.65)	44.5 (1.75)
<b>652</b>	125 (4.92)	94.5 (3.72)	66 (2.60)	33 (1.30)	69 (2.72)	34.5 (1.36)	2.5 (0.10)	29 (1.14)	14.5 (0.57)	41.75 (1.64)	42 (1.65)	50 (1.97)
<b>653</b>	178.4 (7.02)	117.5 (4.63)	90 (3.54)	45 (1.77)	93 (3.66)	46.5 (1.83)	3 (0.12)	-	-	52 (2.05)	-	62 (2.44)

	A	B	C	D	E	F	G
<b>653 High Pressure</b>	193 (7.60)	132 (6.20)	90 (3.54)	45 (1.77)	93 (3.66)	46.5 (1.83)	3 (0.12)

	N	P	Q	R	S	ØT	V	ØW	X	Y
<b>651</b>	20 (0.79)	10 (0.39)	50 (1.97)	70 (2.76)	92 (3.62)	7 (0.28)	6.3 (0.25)	11 (0.43)	39.1 (1.54)	M30 x 2
<b>652</b>	20 (0.79)	10 (0.39)	61.5 (2.42)	84 (3.31)	106 (4.17)	7 (0.28)	6.3 (0.25)	11 (0.43)	43.5 (1.71)	M37 x 2
<b>653</b>	40 (1.57)	20 (0.79)	82 (3.23)	104 (4.09)	126 (4.96)	-	6.3 (0.25)	11 (0.43)	-	-

**651/652/653 Series**

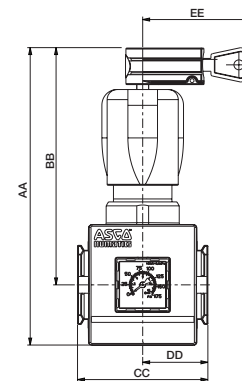

**Cross Section - 651/652/653 Series Regulator**

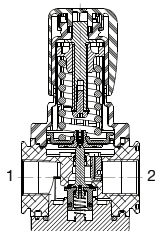

	AA	BB	CC	DD	EE
<b>651</b>	121.5 (4.78)	96 (3.78)	50 (1.97)	25 (0.98)	55 (2.17)
<b>652</b>	151 (5.94)	120 (4.72)	66 (2.60)	33 (1.30)	55 (2.17)
<b>653</b>	192 (7.56)	137 (5.39)	90 (3.54)	45 (1.77)	55 (2.17)



Regulator Flow Charts

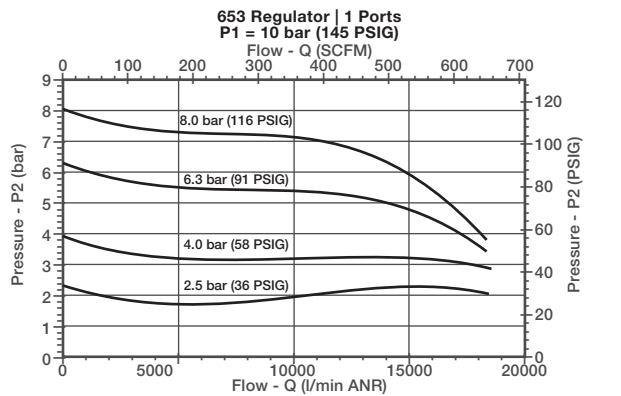
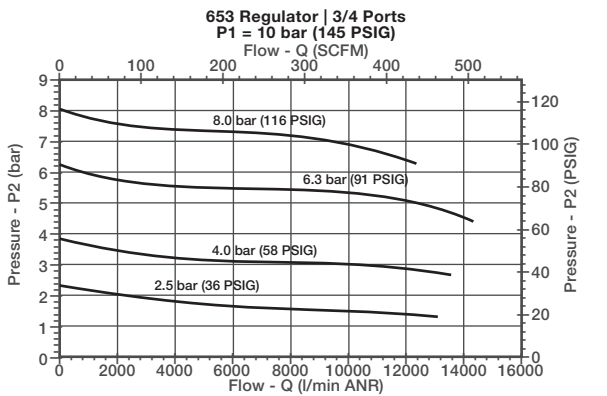
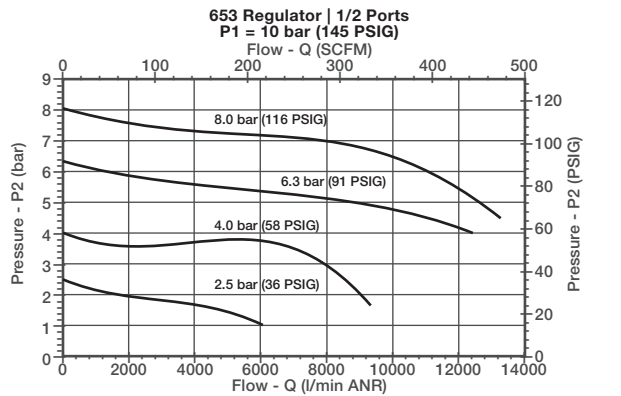
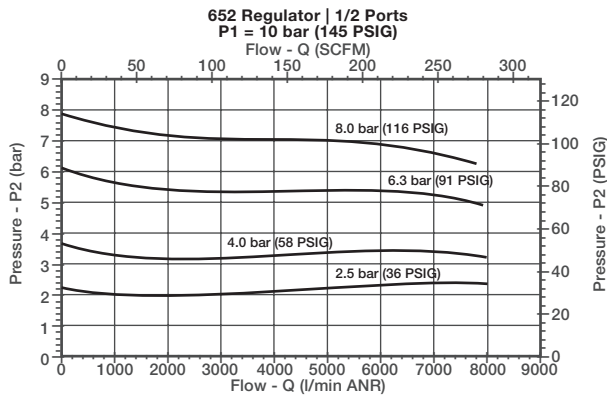
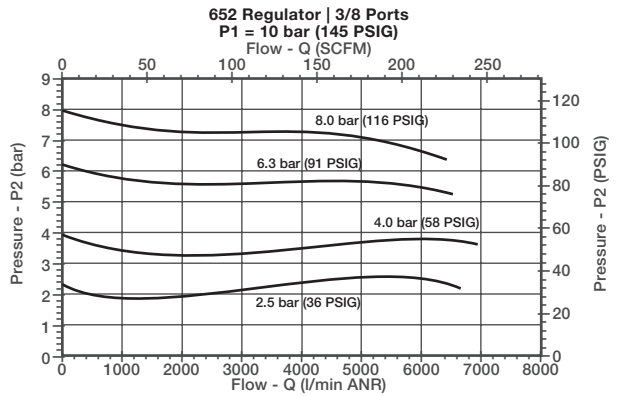
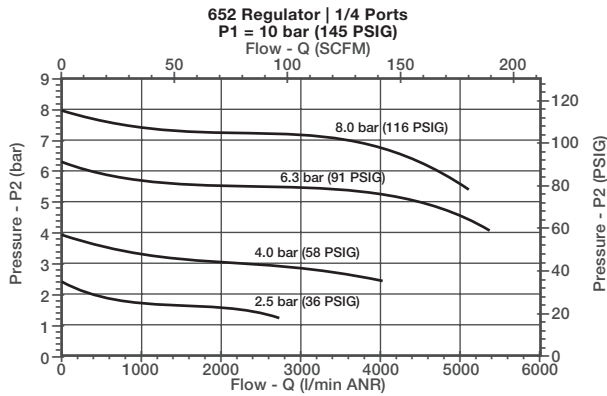
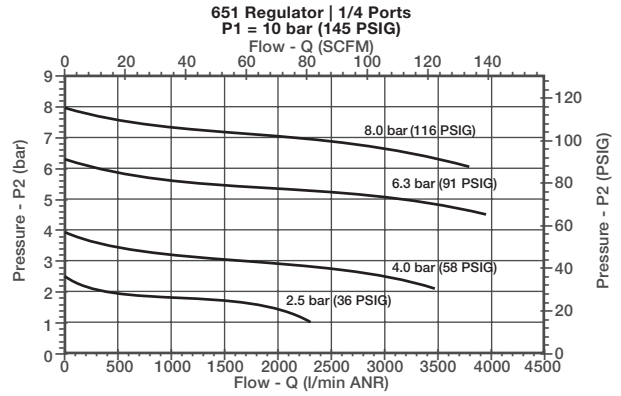
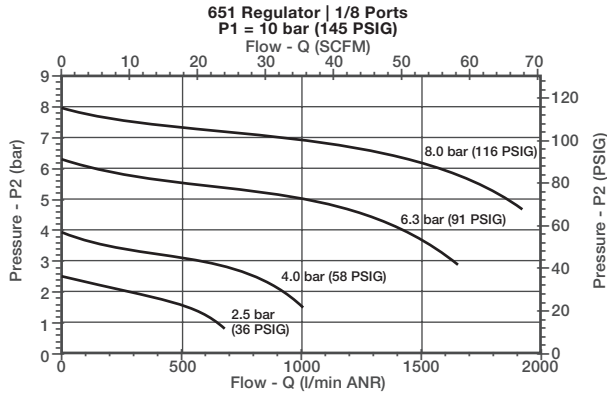

## MANIFOLD REGULATOR

- High flow with a wide range of adjustable output pressure ranges
- Allows for a common inlet supply pressure within the regulator manifold, while maintaining several adjustable output pressures
- Optional low profile gauge, round gauge, digital gauge and digital pressure switch
- Optional extended temperature range of -40 °F to 176 °F (-40 °C to 80 °C)
- Key lockable and tamper proof options

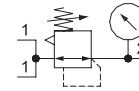

Performance Data			
Series		651	652
Port Sizes	P1 (Inlet)	1/4	1/2
	P2 (Outlet)	1/8	3/8
Thread Type		NPTF, G & Rc	
Nominal Flow - Per ISO 6358		SCFM (L/min ANR)	
P1 = 145 PSI (10 bar) Setpoint P2 = 91.4 PSI (6.3 bar) ΔP = 14.5 PSI (1 bar)		29.5 (840)	280.0 (8000)
Maximum Pressure PSIG (bar) P1		232 (16)	
Adjustable Pressure Ranges - PSI (bar) P2		3 to 45 (0.2 to 3)	
		3 to 60 (0.2 to 4)	
		7 to 125 (0.5 to 8)	
		7 to 145 (0.5 to 10)	
Ambient Temperature Range °F (°C)		-4 to 122 (-20 to 50)	
Fluid Temperature Range °F (°C)		-4 to 122 (-20 to 50)	
Fluid		Air or Inert Gas	
Weight lbs. (kg)		0.47 (0.215)	0.93 (0.422)

Materials in Contact with Fluid	
Body	Aluminum
Seals	NBR/FKM
Springs	Stainless Steel

How to Order - Manifold Regulator

8 651 A M 0 0 2 F A00 G 0

**Port Type**

- 8 = NPTF
- <sup>1</sup> G = ISO 228/1-G
- J = ISO 7/1 Rc

**Product Series**

- 651
- 652

**Revision**

- A

**Product Type**

- <sup>2</sup> M = Manifold Regulator
- M



**Port Size**

- 2 = 1/4 In (1/8 Out) (651 Series)
- 4 = 1/2 In (3/8 Out) (652 Series)

**Gauge Type**

- B = Digital Pressure Switch - PNP
- C = Digital Pressure Switch - NPN
- D = Digital Gauge
- F = Low Profile Gauge PSI/bar
- G = Low Profile Gauge bar/PSI
- H = Low Profile Gauge PSI/bar with Pressure Range Indicator
- J = Low Profile Gauge bar/PSI with Pressure Range Indicator
- N = No Gauge with Port Plate (1/8 NPTF)
- P = No Gauge with Port Plate (1/8 ISO 7/1 Rc)
- Q = Round Gauge bar/PSI
- R = Round Gauge PSI/bar
- 0 = No Gauge Port

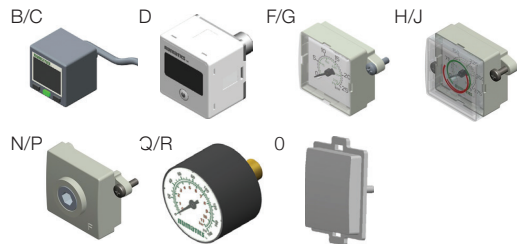

**Pressure Range**

- D = 3–45 PSIG/0.2–3 bar
- E = 3–60 PSIG/0.2–4 bar
- G = 7–125 PSIG/0.5–8 bar
- H = 7–145 PSIG/0.5–10 bar

**Options**

- A00 = No Options
- 101 = Side Mounting Brackets
- 102 = Panel Nut
- 103 = Tamper Resistant
- 104 = Key Lockable
- 105 = High Temperature (80 °C/176 °F)
- <sup>4</sup> 106 = Low Temperature (-40 °C/-40 °F)
- 109 = FKM Seals
- 113 = Stainless Steel Fasteners
- 114 = Provision for Key Lockable Option
- 117 = ATEX Zones 1–21 ⚠
- 119 = Panel Bracket with Panel Nut
- 121 = Non-relieving
- 122 = Bottom Oriented Pressure Adjustment
- 123 = Gauge Type Mounted for Right-to-Left Flow
- 202 = 105 + 109
- 2A9 = 105 + 106

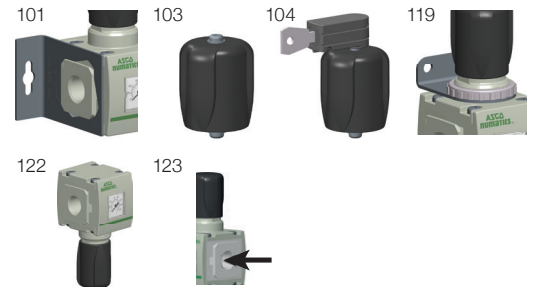

1 Conforms to ISO standards 1179-1  
 2 Relieving Standard; use option 121 for Non-relieving  
 3 If multiple options are required, please use the online CAD configurator on the website to generate the part number ([www.asco.com](http://www.asco.com)), or consult factory  
 4 Compressed air must be dry enough so no ice formation is present on the product

**Dimensions: mm (inches) 651/652 Series Manifold Regulator**

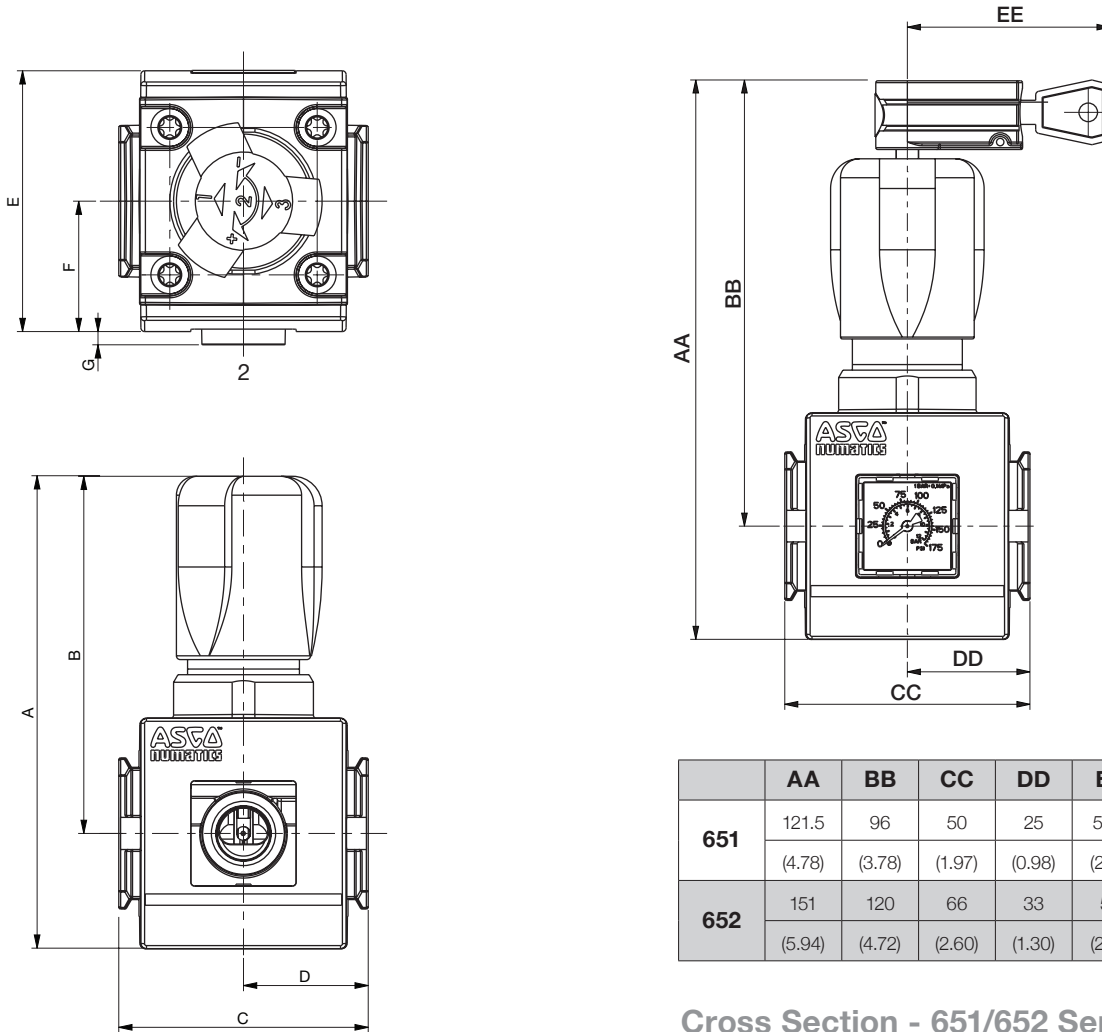

	AA	BB	CC	DD	EE
<b>651</b>	121.5	96	50	25	54.6
	(4.78)	(3.78)	(1.97)	(0.98)	(2.15)
<b>652</b>	151	120	66	33	55
	(5.94)	(4.72)	(2.60)	(1.30)	(2.17)

	A	B	C	D	E	F	G
<b>651</b>	103	77.5	50	25	58	29	0.3
	(4.06)	(3.05)	(1.97)	(0.98)	(2.28)	(1.14)	(0.01)
<b>652</b>	125	94.5	66	33	69	34.5	3.5
	(4.92)	(3.72)	(2.60)	(1.30)	(2.72)	(1.36)	(0.14)

**Cross Section - 651/652 Series Manifold Regulator**

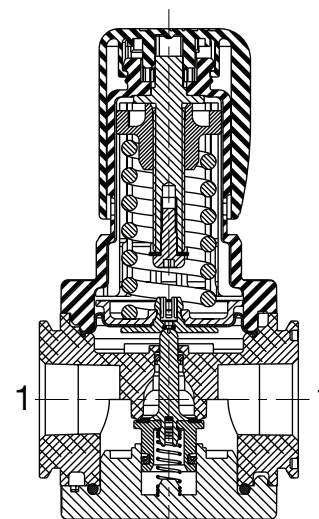

**PARTICULATE FILTER/REGULATOR**

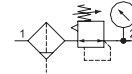

- High flow with a wide range of adjustable output pressure ranges
- Optional low profile gauge, round gauge, digital gauge or digital pressure switch
- Optional extended temperature range of -40 °F to 176 °F (-40 °C to 80 °C)
- Sintered polyethylene elements, with centrifugal separator, include 5, 25 and 40 Microns
- Threaded ports allow for individual or modular mounting
- Innovative two position plastic drain with manual and semi-automatic functions. Additional drains include an automatic style (brass) and manual (stainless steel)
- Polycarbonate and Aluminum bowls with a selection of sight gauge materials that meet industry and application requirements
- Key lockable and tamper resistant models
- Air purity class according to ISO 8573-1: 2010



Performance Data					
Series			651	652	653
Port Sizes			1/8, 1/4	1/4, 3/8, 1/2	1/2, 3/4, 1
Thread Type			NPTF, G & Rc		
Nominal Flow - Per ISO 6358 P1 = 145 PSI (10 bar) Setpoint P2 = 91.4 PSI (6.3 bar) ΔP = 14.5 PSI (1 bar)	1/8	Micron Rating	SCFM (L/min ANR)		
		5μ	25.1 (710)	-	-
		25μ	25.8 (730)	-	-
	1/4	5μ	79.1 (2240)	133.0 (3800)	-
		25μ	83.4 (2360)	144.2 (4120)	-
		40μ	100.1 (2840)	150.5 (4300)	-
	3/8	5μ	-	155.8 (4450)	-
		25μ	-	189.7 (5420)	-
		40μ	-	196.0 (5590)	-
	1/2	5μ	-	157.2 (4490)	275.4 (7800)
		25μ	-	192.5 (5500)	278.9 (7900)
		40μ	-	203.0 (5800)	307.2 (8700)
	3/4	5μ	-	-	314.3 (8900)
		25μ	-	-	317.1 (9000)
		40μ	-	-	353.1 (10000)
	1	5μ	-	-	317.8 (9000)
		25μ	-	-	353.1 (10000)
		40μ	-	-	370.8 (10500)
Maximum Inlet Pressure PSIG (bar) P1	Polycarbonate Bowl	232 (16)		174 (12)	
	Aluminum Bowl	232 (16)		290 (20)	
Adjustable Pressure Ranges PSIG (bar) P2			3 to 45 (0.2 to 3)		
			3 to 60 (0.2 to 4)		
			7 to 125 (0.5 to 8)		
			7 to 145 (0.5 to 10)		
			-	-	7 to 232 (0.5 to 16)*
Ambient Temperature Range °F (°C)			-4 to 122 (-20 to 50)		
Fluid Temperature Range °F (°C)			-4 to 122 (-20 to 50)		
Fluid			Air or Inert Gas		
Weight lbs. (kg)	w/Polycarbonate Bowl	0.62 (0.304)	1.20 (0.546)	2.90 (1.315)	
	w/Aluminum Bowl	0.99 (0.449)	1.52 (0.688)	3.45 (1.565)/3.90 (1.769)*	

\* High pressure assisted version

Materials in Contact with Fluid		Air Purity Class - ISO 8573-1: 2010	
Body	Aluminum	5μ	(5:8:4)
Seals	NBR/FKM	25μ	(6:8:4)
Springs	Stainless Steel	40μ	(7:8:4)
Filter Element	Sintered Polyethylene		
Bowl	Polycarbonate or Aluminum		
Poppet	Brass		
Stem	PA		

**How to Order - Particulate Filter/Regulator**

**8** **651** **A** **P** **B** **P** **2** **F** **A00** **G** **N**

**Port Type**  
 8 = NPTF  
 G = ISO 228/1-G  
 J = ISO 7/1 Rc

**Product Series**  
 651  
 652  
 653

**Revision**  
 A

**Product Type**  
 K = Filter/Regulator - Particulate with Internal Flow Check (652 only)  
 P = Filter/Regulator - Particulate

**Elements**  
 A = 40 Micron (Green)  
 B = 5 Micron (White)  
 J = 25 Micron (Yellow)

**Bowl Type**  
 K = Metal Bowl without Sight Gauge  
 L = Metal Bowl with Sight Gauge (Glass)  
 M = Metal Bowl with Sight Gauge (Polyamide)  
 N = Polycarbonate Bowl without Bowl Guard (651 only)  
 P = Polycarbonate Bowl with Bowl Guard

**Port Size**  
 1 = 1/8 (651 Series)  
 2 = 1/4 (651 or 652 Series)  
 3 = 3/8 (652 Series)  
 4 = 1/2 (652 or 653 Series)  
 5 = 3/4 (653 Series)  
 6 = 1 (653 Series)

**Gauge Type**  
 B = Digital Pressure Switch - PNP  
 C = Digital Pressure Switch - NPN  
 D = Digital Gauge  
 F = Low Profile Gauge PSI/bar  
 G = Low Profile Gauge bar/PSI  
 H = Low Profile Gauge PSI/bar with Pressure Range Indicator  
 J = Low Profile Gauge bar/PSI with Pressure Range Indicator  
 N = No Gauge with Port Plate (1/8 NPTF)  
 P = No Gauge with Port Plate (1/8 ISO 7/1 Rc)  
 Q = Round Gauge bar/PSI  
 R = Round Gauge PSI/bar  
 0 = No Gauge Port

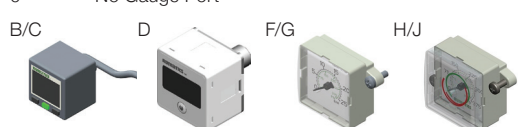
**B/C** **D** **F/G** **H/J**  

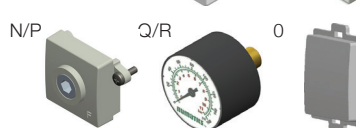
**N/P** **Q/R** **0**  

**Drain Type**  
 0 = No Drain  
 A = Auto Drain Normally Open  
 N = Manual - Semi-automatic Drain  
 Q = Manual Drain - Stainless Steel



**Pressure Range**  
 D = 3-45 PSIG/0.2-3 bar  
 E = 3-60 PSIG/0.2-4 bar  
 G = 7-125 PSIG/0.5-8 bar  
 H = 7-145 PSIG/0.5-10 bar  
 N = 7-232 PSIG/0.5-16 bar (653 only)

**Options**  
 A00 = No Options  
 101 = Side Mounting Brackets  
 102 = Panel Nut (651 and 652 only)  
 103 = Tamper Resistant  
 104 = Key Lockable  
 105 = High Temperature (80 °C/176 °F)  
 106 = Low Temperature (-40 °C/-40 °F)  
 109 = FKM Seals  
 113 = Stainless Steel Fasteners (652 and 653 only)  
 114 = Provision for Key Lockable Option  
 117 = ATEX Zones 1-21   
 119 = Panel Bracket with Panel Nut (651 and 652 only)  
 121 = Non-relieving  
 123 = Gauge Type Mounted for Right-to-Left Flow  
 202 = 105 + 109  
 2A9 = 105 + 106

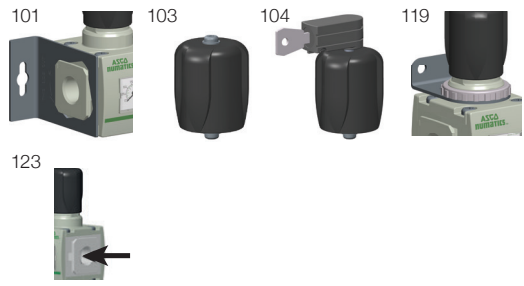

- Conforms to ISO standards 1179-1
- Metal Bowl Types K, L, or M only
- If multiple options are required, please use the online CAD configurator on the website to generate the part number ([www.asco.com](http://www.asco.com)), or consult factory
- Compressed air must be dry enough so no ice formation is present on the product. All bowls should be emptied prior to ambient temperatures dropping below 32 °F (0 °C)

Dimensions: mm (inches) 651/652/653 Series Particulate Filter/Regulator

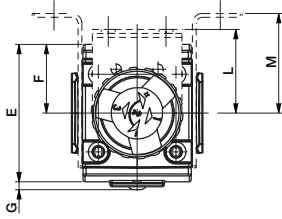

651/652 Series

653 Series

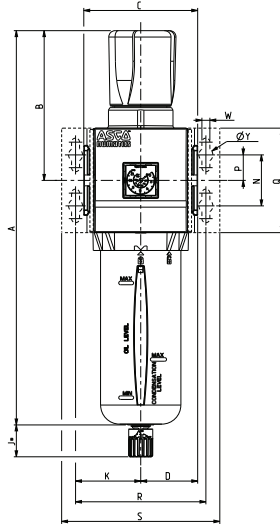
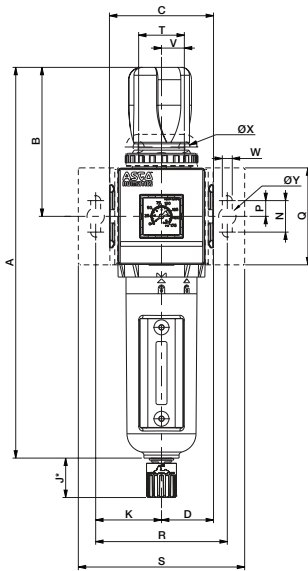

653 Series High Pressure  
232 PSIG (16 bar)

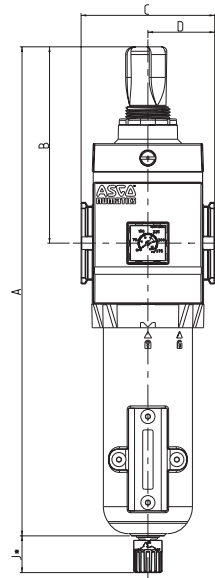

	A	B	C	D	E
653 High Pressure	329.5	132	90	45	93.6
	(12.97)	(6.20)	(3.54)	(1.77)	(3.69)

	F	G	H	J*
653 High Pressure	46.2	2.7	158.9	25
	(1.84)	(0.11)	(6.26)	(0.98)

	A	B	C	D	E	F	G	H	J*	K	L	M
651	215.5	77.5	50	25	58	29	3.4	116	25	35	42	44.5
	(8.48)	(3.05)	(1.97)	(0.98)	(2.28)	(1.14)	(0.13)	(4.57)	(0.98)	(1.38)	(1.65)	(1.75)
652	248	94.5	66	33	69	30.5	4	135	25	41.75	42	50
	(9.76)	(3.72)	(2.60)	(1.30)	(2.72)	(1.20)	(0.16)	(5.31)	(0.98)	(1.64)	(1.65)	(1.97)
653	315.2	117.5	90	45	93.6	46.8	2.7	155.4	25	52	-	62
	(12.41)	(4.63)	(3.54)	(1.77)	(3.69)	(1.84)	(0.11)	(6.12)	(0.98)	(2.05)	-	(2.44)

	N	P	Q	R	S	T	V	W	ØX	ØY	ZB
651	20	10	50	70	92	29	14.5	6.3	7	11	M30 x 2
	(0.79)	(0.39)	(1.97)	(2.76)	(3.62)	(1.14)	(0.57)	(0.25)	(0.28)	(0.43)	
652	20	10	61.5	84	105.5	29	14.5	6.3	7	11	M37 x 2
	(0.79)	(0.39)	(2.42)	(3.31)	(4.15)	(1.14)	(0.57)	(0.25)	(0.28)	(0.43)	
653	40	20	82	104	126	-	-	6.3	-	11	-
	(1.57)	(0.79)	(3.23)	(4.09)	(4.96)	-	-	(0.25)	-	(0.43)	

\* Variable dimension based on type of drain that is specified; if an Automatic Drain is specified, add another 5mm to J dimension.

Cross Section -  
651/652/653 Series  
Particulate Filter/  
Regulator

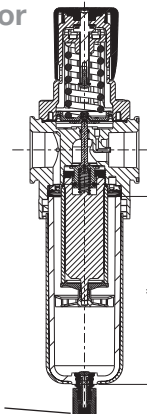

To remove bowl allow:  
651 - 44mm (1.8in)  
652 - 75mm (3.0in)  
653 - 100mm (4.0in)  
from the bottom of the bowl drain

**Particulate Filter/Regulator Flow Charts**

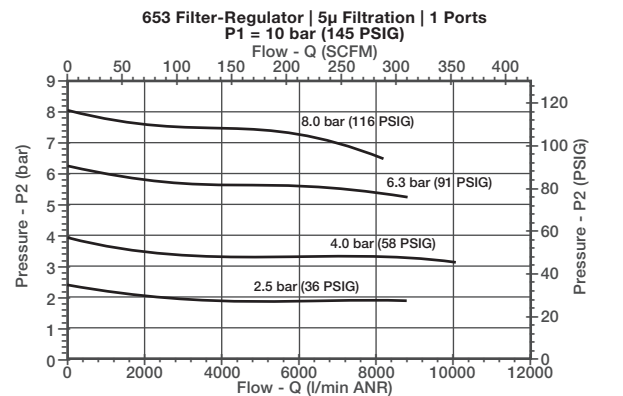
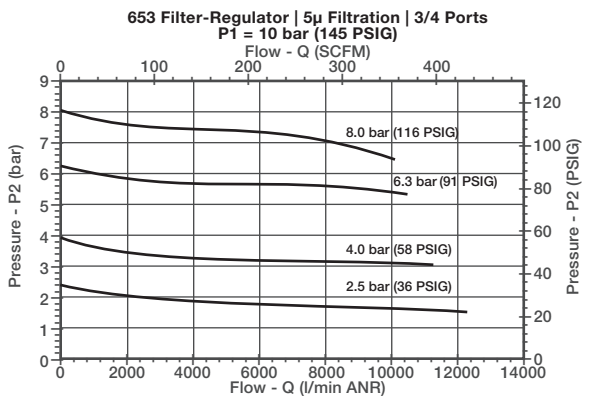
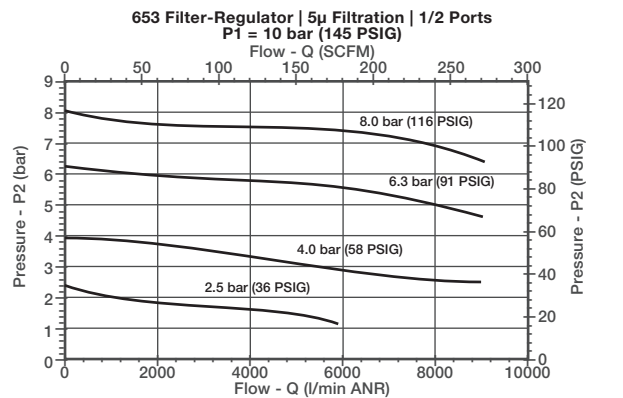
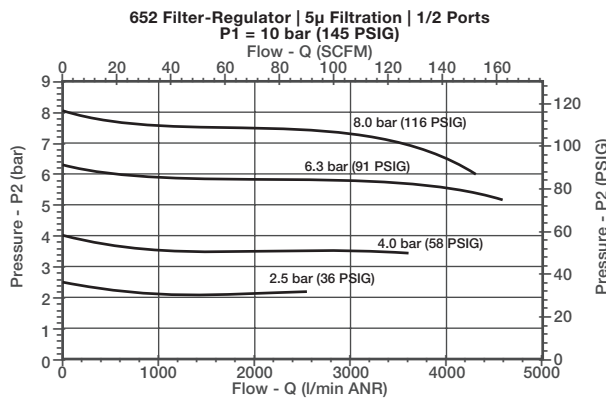
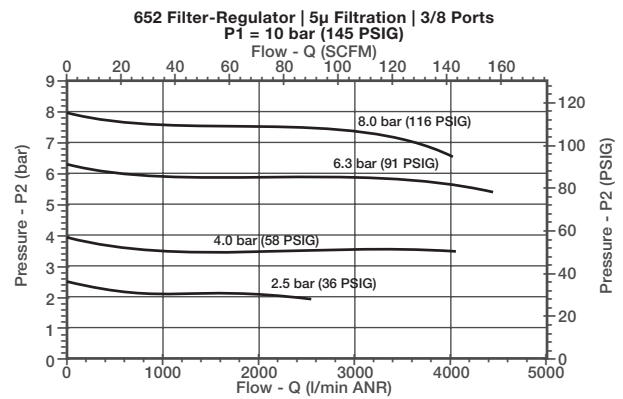
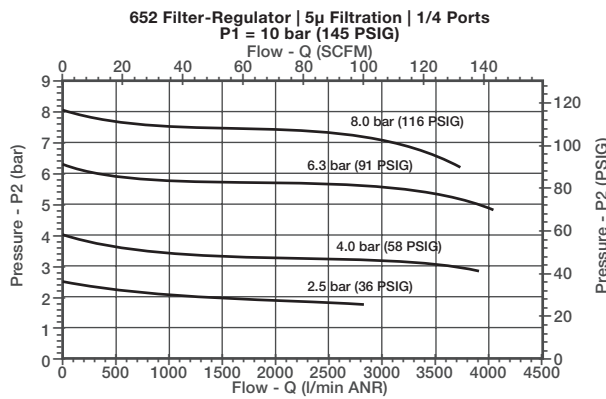
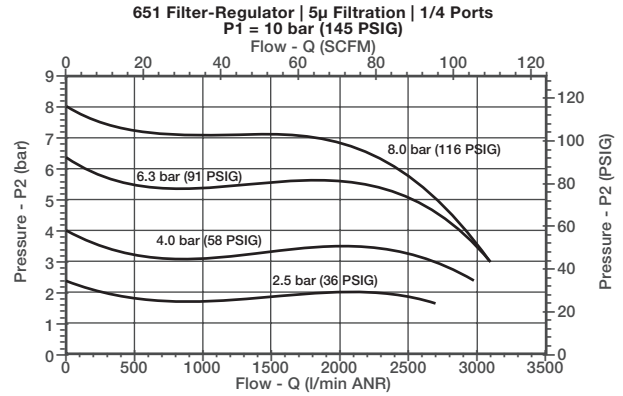
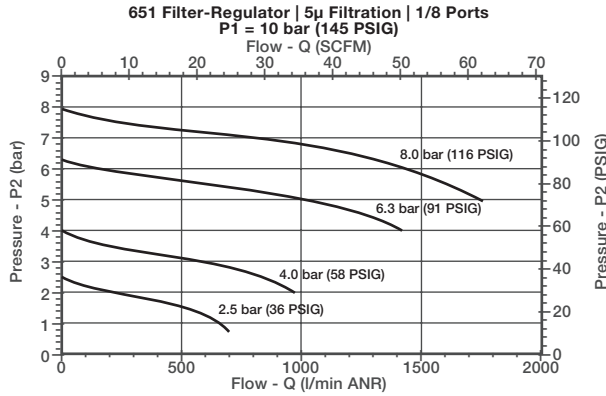



**COALESCING FILTER/REGULATOR**

- Extensive range of coalescing filter elements to remove oil and sub-micron particles down to 0.01 microns. Air purity class according to ISO 8573-1: 2010
- Optional 3 micron pre-filter integrated in the coalescing element eliminates the need for a separate particulate element
- Optional low profile gauge, round gauge, digital gauge or digital pressure switch
- Optional extended temperature range up to 176 °F (80 °C)
- Threaded ports allow for individual or modular mounting
- Innovative two position plastic drain with manual and semi-automatic functions Additional drains include an automatic style (brass) and manual (stainless steel)
- Polycarbonate and Aluminum bowls with a selection of sight gauge materials that meet industry and application requirements
- Key lockable and tamper proof models

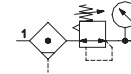

Performance Data					
Series			651	652	653
Port Sizes			1/8, 1/4	1/4, 3/8, 1/2	1/2, 3/4, 1
Thread Type			NPTF, G & Rc		
Nominal Flow - Per ISO 6358 P1 = 145 PSI (10 bar) Setpoint P2 = 91.4 PSI (6.3 bar) ΔP = 5 PSI (0.35 bar)	1/8	Micron Rating	SCFM (L/min ANR)		
		0.3 µm	8.5 (240)	-	-
	1/4	0.01 µm	5.9 (170)	-	-
		0.3 µm	10.3 (290)	11.3 (320)	-
	3/8	0.01 µm	7.2 (200)	10.2 (290)	-
		0.3 µm	-	20.5 (580)	-
	1/2	0.01 µm	-	18.9 (540)	-
		0.3 µm	-	20.8 (590)	26.5 (750)
	3/4	0.01 µm	-	19.1 (540)	21.2 (600)
		0.3 µm	-	-	26.5 (750)
	1	0.01 µm	-	-	21.2 (600)
		0.3 µm	-	-	26.5 (750)
Maximum /Inlet Pressure PSIG (bar) P1	Polycarbonate Bowl		232 (16)		174 (12)
	Aluminum Bowl		232 (16)		290 (20)
Adjustable Pressure Ranges PSIG (bar) P2			3 to 45 (0.2 to 3)		
			3 to 60 (0.2 to 4)		
			7 to 125 (0.5 to 8)		
			7 to 145 (0.5 to 10)		
			-	7 to 232 (0.5 to 16)*	
Ambient Temperature Range °F (°C)			35 to 122 (1.7 to 50)		
Fluid Temperature Range °F (°C)			35 to 122 (1.7 to 50)		
Fluid			Air or Inert Gas		
Weight lbs. (kg)	w/Polycarbonate Bowl		0.68 (0.308)	1.24 (0.564)	2.90 (1.315)
	w/Aluminum Bowl		1.00 (0.453)	1.55 (0.705)	3.50 (1.588)/3.95 (1.792)*

\* High pressure assisted version

Materials in Contact with Fluid	
Body	Aluminum
Seals	NBR/FKM
Springs	Stainless Steel
Filter Element	Borosilicate Microfiber & Polyester
Filter Element End Cap	Polypropylene
Bowl	Polycarbonate or Aluminum
Poppet	Brass

Air Purity Class - ISO 8573-1: 2010*	
0.3 µm	(3:7:3)
0.01 µm	(2:7:2)

\* 651 Series maximum flow at 91.4 PSI (6.3 bar) inlet pressure to maintain air purity class is 3.5 SCFM (100 L/min)

\* 652 Series maximum flow at 91.4 PSI (6.3 bar) inlet pressure to maintain air purity class is 10.6 SCFM (303 L/min)

\* 653 Series maximum flow at 91.4 PSI (6.3 bar) inlet pressure to maintain air purity class is 25.0 SCFM (707 L/min)

**How to Order - Coalescing Filter/Regulator**

**8 651 A C D P 2 F A00 G N**



**Port Type**  
 8 = NPTF  
 G = ISO 228/1-G  
 J = ISO 7/1 Rc

**Product Series**  
 651  
 652  
 653

**Revision**  
 A

**Product Type**  
 C = Filter/Regulator - Coalescing  
 K = Filter/Regulator - Coalescing with Internal Flow Check (652 only)

**Elements**  
 D = 0.3 Micron - Coalescer (Green)  
 E = 0.01 Micron - Coalescer (Red)  
 M = 0.3 Micron Coalescer with 3 Micron Prefilter (Green)  
 N = 0.01 Micron Coalescer with 3 Micron Prefilter (Red)



D/M  E/N 

**Bowl Type**  
 K = Metal Bowl without Sight Gauge  
 L = Metal Bowl with Sight Gauge (Glass)  
 M = Metal Bowl with Sight Gauge (Polyamide)  
 N = Polycarbonate Bowl without Bowl Guard (651 only)  
 P = Polycarbonate Bowl with Bowl Guard

**Port Size**  
 1 = 1/8 (651 Series)  
 2 = 1/4 (651 or 652 Series)  
 3 = 3/8 (652 Series)  
 4 = 1/2 (652 or 653 Series)  
 5 = 3/4 (653 Series)  
 6 = 1 (653 Series)





**Gauge Type**  
 B = Digital Pressure Switch - PNP  
 C = Digital Pressure Switch - NPN  
 D = Digital Gauge  
 F = Low Profile Gauge PSI/bar  
 G = Low Profile Gauge bar/PSI  
 H = Low Profile Gauge PSI/bar with Pressure Range Indicator  
 J = Low Profile Gauge bar/PSI with Pressure Range Indicator  
 N = No Gauge with Port Plate (1/8 NPTF)  
 P = No Gauge with Port Plate (1/8 ISO 7/1 Rc)  
 Q = Round Gauge bar/PSI  
 R = Round Gauge PSI/bar  
 0 = No Gauge Port

**Drain Type**  
 0 = No Drain  
 A = Auto Drain Normally Open  
 N = Manual - Semi-automatic Drain  
 Q = Manual Drain - Stainless Steel

A  N  Q 

**Pressure Range**  
 D = 3-45 PSIG/0.2-3 bar  
 E = 3-60 PSIG/0.2-4 bar  
 G = 7-125 PSIG/0.5-8 bar  
 H = 7-145 PSIG/0.5-10 bar  
 N = 7-232 PSIG/0.5-16 bar (653 only)

**Options**  
 A00 = No Options  
 101 = Side Mounting Brackets  
 102 = Panel Nut (651 and 652 only)  
 103 = Tamper Resistant  
 104 = Key Lockable  
 105 = High Temperature (80 °C/176 °F)  
 109 = FKM Seals  
 113 = Stainless Steel Fasteners (652 and 653 only)  
 114 = Provision for Key Lockable Option  
 117 = ATEX Zones 1-21   
 119 = Panel Bracket with Panel Nut (651 and 652 only)  
 121 = Non-relieving  
 123 = Gauge Type Mounted for Right-to-Left Flow  
 202 = 105 + 109

101  103  104  119 

123 

1 Conforms to ISO standards 1179-1  
 2 Metal Bowls Types K, L, or M only  
 3 If multiple options are required, please use the online CAD configurator on the website to generate the part number (www.asco.com), or consult factory

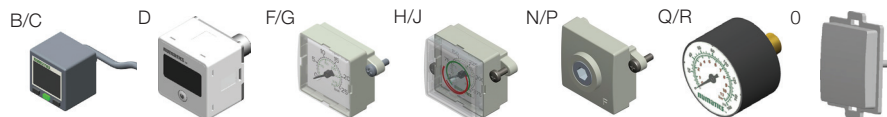

Dimensions: mm (inches) 651/652/653 Series Coalescing Filter/Regulator

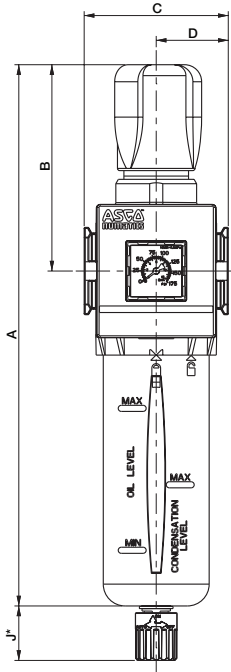
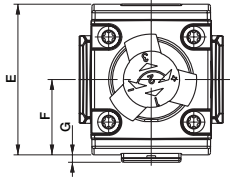

**653 Series High Pressure**  
232 PSIG (16 bar)

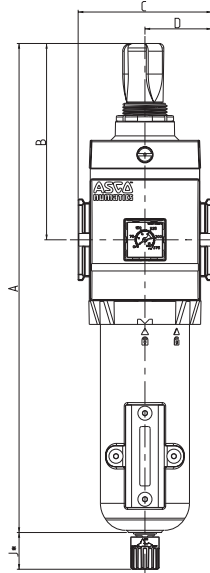

	A	B	C	D	E
<b>653 High Pressure</b>	329.5 (12.97)	132 (6.20)	90 (3.54)	45 (1.77)	93.6 (3.69)

**Cross Section -**  
651/652/653 Series  
Coalescing  
Filter/Regulator

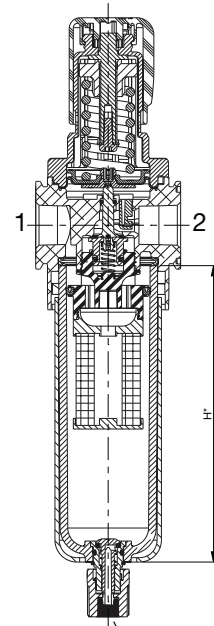

To remove bowl allow:  
651 - 60mm (2.4in)  
652 - 80mm (3.2in)  
653 - 105mm (4.2in)  
from the bottom of the bowl drain

	A	B	C	D	E
<b>651</b>	215.5 (8.48)	77.5 (3.05)	50 (1.97)	25 (0.98)	58 (2.28)
<b>652</b>	248 (9.76)	94.5 (3.72)	66 (2.60)	33 (1.30)	69 (2.72)
<b>653</b>	311.8 (12.28)	117.5 (4.63)	90 (3.54)	45 (1.77)	93.6 (3.69)

	F	G	H	J*
<b>653 High Pressure</b>	46.2 (1.84)	2.7 (0.11)	158.9 (6.26)	25 (0.98)

	F	G	H	J*
<b>651</b>	29 (1.14)	5 (0.20)	116 (4.57)	25 (0.98)
<b>652</b>	30.5 (1.20)	2.5 (0.10)	135 (5.31)	25 (0.98)
<b>653</b>	46.8 (1.84)	2.7 (0.11)	155.4 (6.12)	25 (0.98)

\* Variable dimension based on type of drain that is specified; if an Automatic Drain is specified, add another 5mm to J dimension.

**Coalescing Filter/Regulator Flow Charts**

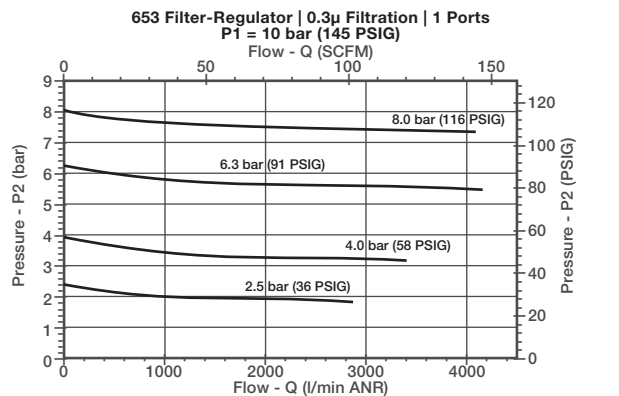
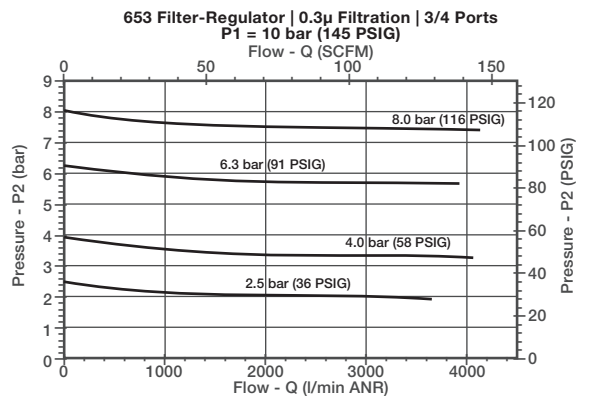
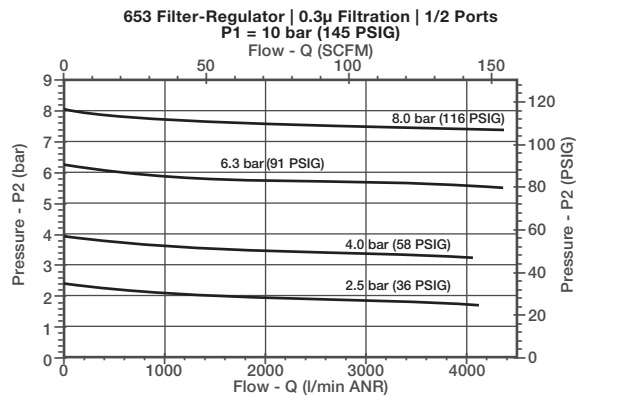
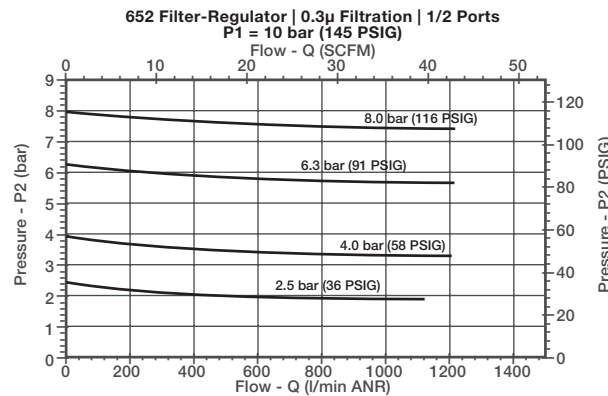
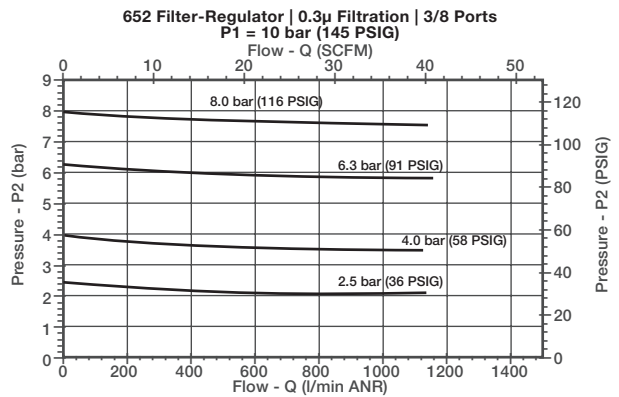
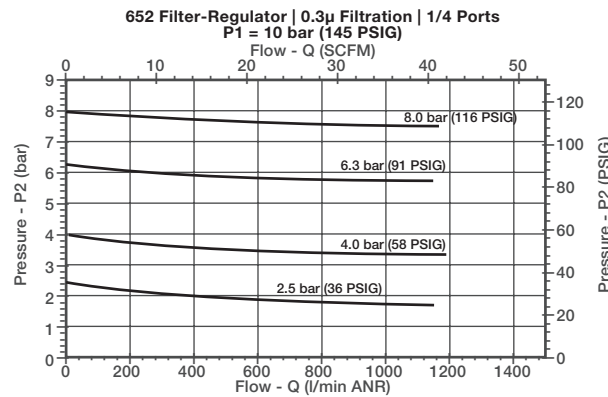
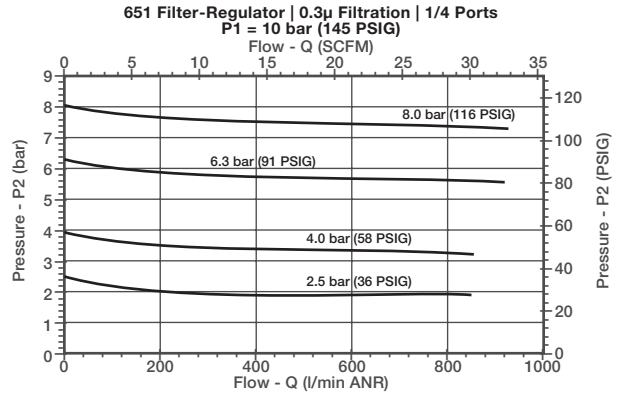
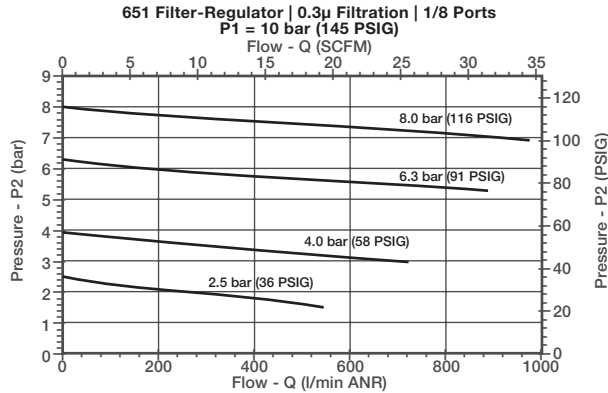

**LUBRICATOR**

- Provides consistent reliable lubrication to the system
- Uses venturi type technology to distribute the lubrication into the compressed air line
- Optional electronic liquid level indicator provides condition monitoring
- Allows fill while under pressure from fill port or bowl by removing the fill plug
- Polycarbonate and Aluminum bowls with a selection of sight gauge materials that meet industry and application requirements
- Recommended oil type: Non-detergent type and without aggressive additives (VG32 - ISO3448)
- Threaded ports allow for individual or modular mounting

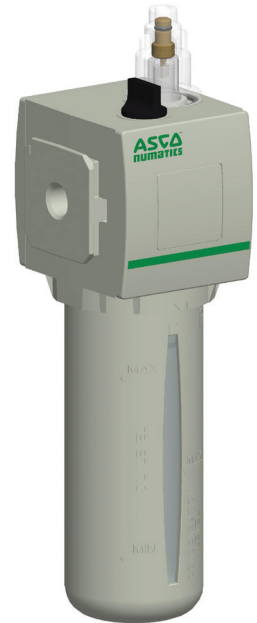

Performance Data				
Series		651	652	653
Port Sizes		1/8, 1/4	1/4, 3/8, 1/2	1/2, 3/4, 1
Thread Type		NPTF, G & Rc		
Nominal Flow - Per ISO 6358  P1 = 91.4 PSI (6.3 bar) ΔP = 11.6 PSI (0.8 bar)		SCFM (L/min ANR)		
	1/8	31.8 (900)	-	-
	1/4	68.5 (1940)	97.3 (2780)	-
	3/8	-	175.0 (5000)	-
	1/2	-	178.5 (5100)	328.4 (9300)
	3/4	-	-	459.1 (13000)
Maximum Pressure PSIG (bar)	Polycarbonate Bowl	145 (10)		
	Aluminum Bowl	145 (10)		232 (16)
Minimum Flow for Lubrication - SCFM (L/min)		0.16 (4.5)	0.71 (20)	8.83 (250)
Ambient Temperature Range °F (°C)		41 to 122 (5 to 50)		
Fluid Temperature Range °F (°C)		41 to 122 (5 to 50)		
Fluid		Air or Inert Gas		
Bowl Capacity - mL (fluid oz.)		45 (1.52)	90 (3.04)	200 (6.76)
Weight lbs. (kg)	Polycarbonate Bowl	0.53 (0.240)	1.16 (0.526)	2.05 (0.930)
	Aluminum Bowl	0.74 (0.334)	1.47 (0.667)	2.55 (1.157)

Materials in Contact with Fluid	
Body	Aluminum
Seals	NBR/FKM

**How to Order - Lubricator**

8 651 A L 0 P 2 0 A00 0 0

**Port Type**

- 8 = NPTF
- <sup>1</sup>G = ISO 228/1-G
- J = ISO 7/1 Rc

**Product Series**

- 651
- 652
- 653

**Revision**

A

**Product Type**

- L = Lubricator

**Bowl Type**

- K = Metal Bowl without Sight Gauge
- L = Metal Bowl with Sight Gauge (Glass)
- M = Metal Bowl with Sight Gauge (Polyamide)
- N = Polycarbonate Bowl without Bowl Guard (651 only)
- P = Polycarbonate Bowl with Bowl Guard

K/L/M



**Options**

- A00 = No Options
- 101 = Side Mounting Brackets
- 108 = Liquid Level Indicator - Electronic
- 109 = FKM Seals
- 117 = ATEX Zones 1-21

101



108



**Port Size**

- 1 = 1/8 (651 Series)
- 2 = 1/4 (651 or 652 Series)
- 3 = 3/8 (652 Series)
- 4 = 1/2 (652 or 653 Series)
- 5 = 3/4 (653 Series)
- 6 = 1 (653 Series)

<sup>1</sup> Conforms to ISO standards 1179-1

<sup>2</sup> If multiple options are required, please use the online CAD configurator on the website to generate the part number ([www.asco.com](http://www.asco.com)), or consult factory

Dimensions: mm (inches) 651/652/653 Series Lubricator

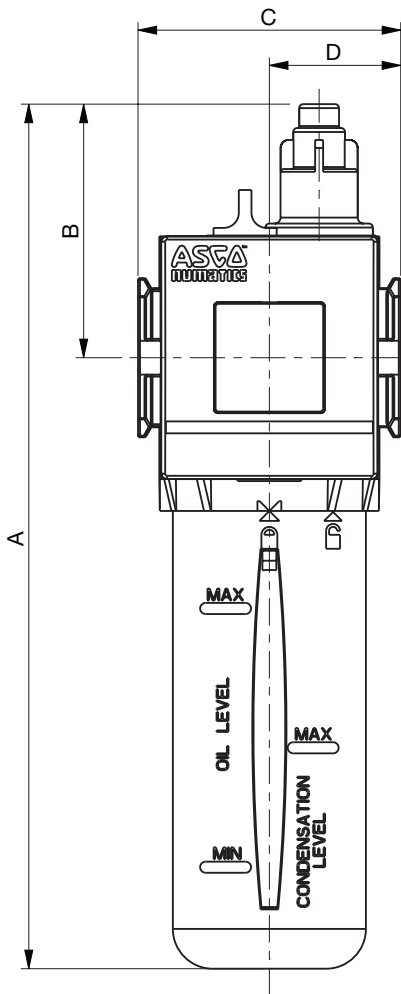
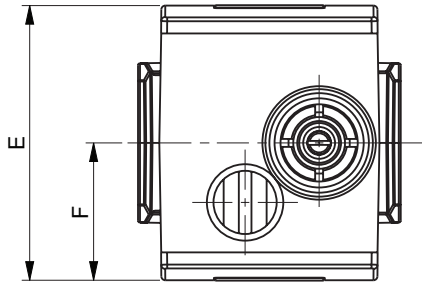

Cross Section - 651/652/653 Series Lubricator

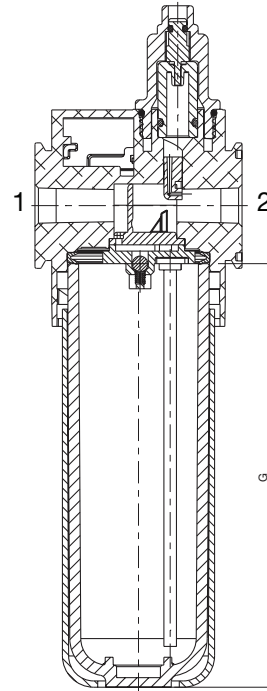

To remove bowl allow:  
651 Series - 20mm (0.8in)  
652/653 Series - 25mm (1.0in)  
from the bottom of the bowl

	A	B	C	D	E	F	G
<b>651</b>	198	58	50	25	58	29	116
	(7.80)	(2.28)	(1.97)	(0.98)	(2.28)	(1.14)	(4.57)
<b>652</b>	217	64	66	33	69	30.5	135
	(8.54)	(2.52)	(2.60)	(1.30)	(2.72)	(1.20)	(5.31)
<b>653</b>	266	75	90	45	93	46.5	155
	(10.47)	(2.95)	(3.54)	(1.77)	(3.66)	(1.83)	(6.10)

**SHUT OFF ISOLATION VALVE**

- Robust and easy-to-operate shut off valve, with lockout (front or back) on handle
- Provides shut off to downstream machinery
- Optional low profile gauge provides clear indication of the downstream pressure, and when the downstream components can be safely removed when pressure (P2) is at zero
- Available as 3/2 or 2/2 construction
- Threaded ports allow for individual or modular mounting

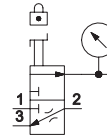

Performance Data							
Series	651		652		653		
Port Sizes	1/8, 1/4		1/4, 3/8, 1/2		1/2, 3/4, 1		
Thread Type	NPTF, G & Rc						
Nominal Flow - Per ISO 6358  P1 = 91.4 PSI (6.3 bar) ΔP = 14.5 PSI (1 bar)	SCFM (L/min ANR)						
		1 → 2	2 → 3	1 → 2	2 → 3	1 → 2	2 → 3
	1/8	50.8 (1440)	8.8 (250)	-	-	-	-
	1/4	166.7 (4720)	8.8 (250)	151.0 (4300)	8.1 (230)	-	-
	3/8	-	-	308.0 (8800)	8.1 (230)	-	-
	1/2	-	-	400.0 (11400)	8.1 (230)	458.0 (12970)	10.6 (300)
	3/4	-	-	-	-	1165.0 (33000)	10.6 (300)
1	-	-	-	-	1833.0 (51900)	10.6 (300)	
Maximum Inlet Pressure PSIG (bar)	232 (16)				290 (20)		
Ambient Temperature Range °F (°C)	14 to 122 (-10 to 50)						
Fluid Temperature Range °F (°C)	14 to 122 (-10 to 50)						
Fluid	Air or Inert Gas						
Weight lbs. (kg)	0.57 (0.260)		0.97 (0.438)		2.08 (0.943)		

Materials in Contact with Fluid	
Body	Aluminum
Ball	Chrome Plated Brass
Seat	PTFE
Seals	NBR/FKM



## How to Order - Shut Off Isolation Valve

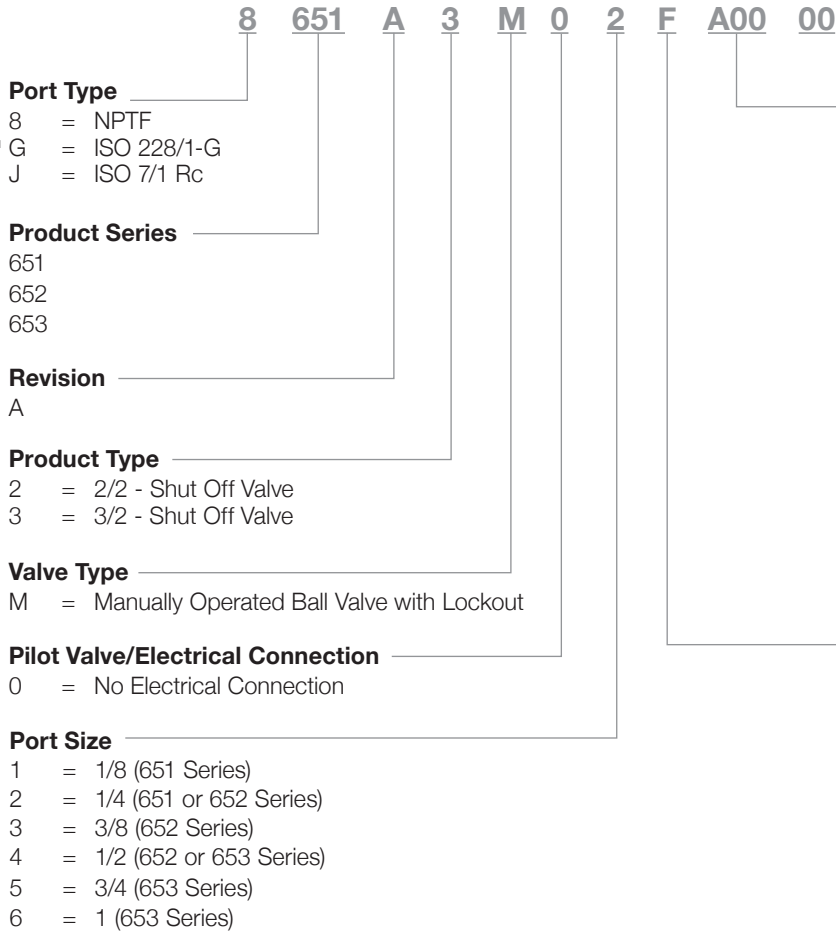

<sup>1</sup> Conforms to ISO standards 1179-1

<sup>2</sup> If multiple options are required, please use the online CAD configurator on the website to generate the part number ([www.asco.com](http://www.asco.com)), or consult factory

**Dimensions: mm (inches) 651/652/653 Series Shut Off Isolation Valve**

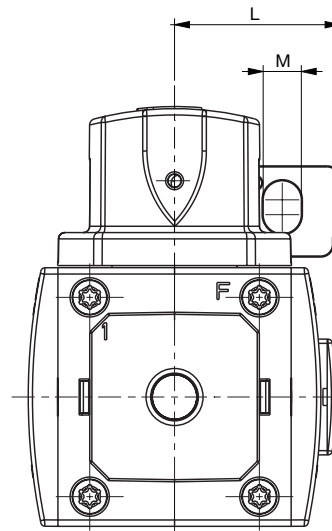
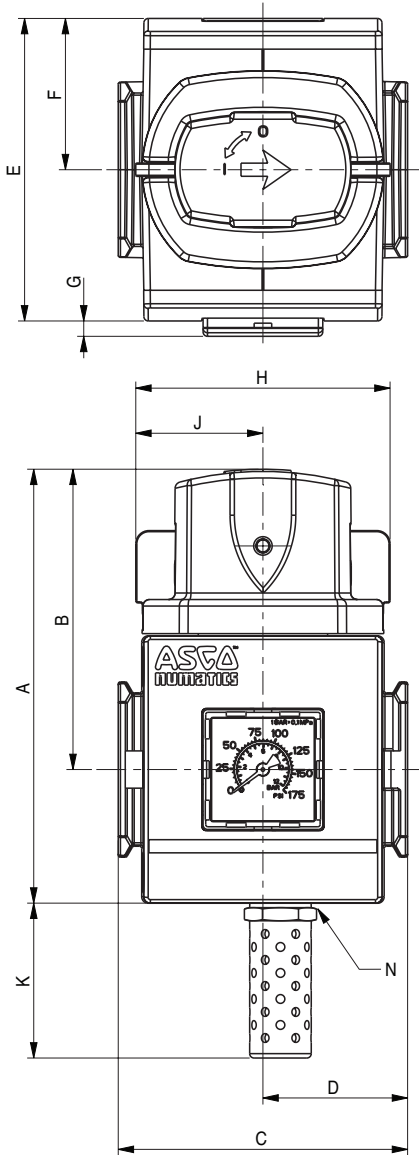

**Cross Section -  
651/652/653 Series  
Shut Off Isolation Valve**

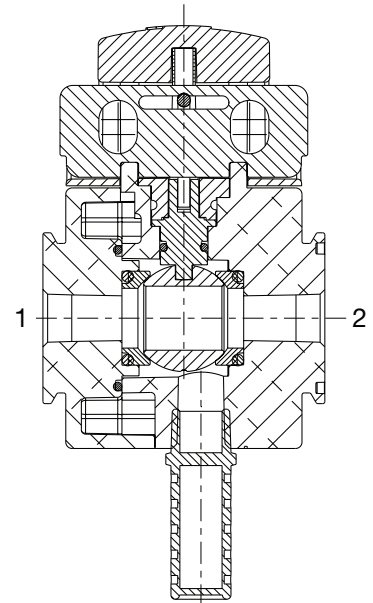

	A	B	C	D	E	F	G	H	J	K	L	M	N
<b>651</b>	90.5	65.5	50	25	58	29	4.4	58	29	35.5	38	9	1/4 NPTF or 1/4 ISO 228/1-G
	(3.56)	(2.58)	(1.97)	(0.98)	(2.28)	(1.14)	(0.17)	(2.28)	(1.14)	(1.40)	(1.50)	(0.35)	
<b>652</b>	99	68	66	33	69	34.5	2.5	58	29	35	38	9	1/4 NPTF or 1/4 ISO 228/1-G
	(3.90)	(2.68)	(2.60)	(1.30)	(2.72)	(1.36)	(0.10)	(2.28)	(1.14)	(1.38)	(1.50)	(0.35)	
<b>653</b>	120	79	90	45	93	46.5	1.9	58	29	46.7	38	9	3/8 NPTF or 3/8 ISO 228/1-G
	(4.72)	(3.11)	(3.54)	(1.77)	(3.66)	(1.83)	(0.07)	(2.28)	(1.14)	(1.84)	(1.50)	(0.35)	

## SLOW START/ QUICK EXHAUST VALVE

- High exhaust capacity for quick depletion of downstream pressure
- Slow Starts provide gradual increase of downstream pressure and full flow once 70% of inlet pressure is reached
- Threaded ports allow for individual or modular mounting
- Manual override (momentary-pulse type) is standard when using the horizontal solenoid operator
- Optional extended temperature range of -40 °F to 176 °F (-40 °C to 80 °C); for air piloted models only (excludes solenoid operators)
- Constructions includes: 3/2 Quick Exhaust, 3/2 Slow Start/Quick Exhaust, and 2/2 Slow Start
- Electrical connections: Coil with DIN terminals; DIN Plug, DIN Plug with LED, and coil with built-in M12 3 Pin male connection (24 VDC)
- Voltages: 24 VDC, 120/60 & 115/50 VAC, 230-50/60 VAC, 24-50/60 VAC

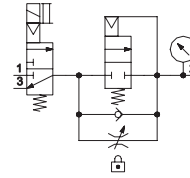

Performance Data							
Series	651		652		653		
Port Sizes	1/8, 1/4		1/4, 3/8, 1/2		1/2, 3/4, 1		
Thread Type	NPTF, G & Rc						
Nominal Flow - Per ISO 6358 P1 = 91.4 PSI (6.3 bar) ΔP = 14.5 PSI (1 bar)	SCFM (L/min ANR)						
		1 → 2	2 → 3	1 → 2	2 → 3	1 → 2	2 → 3
	1/8	27.5 (780)	36.7 (1040)	-	-	-	-
	1/4	35.3 (1000)	39.6 (1120)	53.0 (1500)	74.0 (2100)	-	-
	3/8	-	-	132.0 (3750)	151.0 (4300)	-	-
	1/2	-	-	164.0 (4650)	176.0 (5000)	174.8 (4950)	238.0 (6740)
	3/4	-	-	-	-	257.1 (7280)	313.9 (8890)
1	-	-	-	-	290.6 (8230)	316.4 (8960)	
Minimum Operating Pressure PSIG (bar)	55 (3.8)*						
Maximum Operating Pressure PSIG (bar)	145 (10)						
Ambient Temperature Range °F (°C)	14 to 122 (-10 to 50)						
Fluid Temperature Range °F (°C)	14 to 122 (-10 to 50)						
Fluid	Air or Inert Gas						
Weight lbs. (kg)	0.85 (0.387)		0.97 (0.438)		3.51 (1.592)		

\*If P(1) supply flow is restricted on valves with internal pilot supply, momentary exhaust leakage can occur.

Materials in Contact with Fluid	
Body	Aluminum
Seals	NBR/FKM
Springs	Stainless Steel

Operating Data				
	24/DC	120/60	240/60	24/60
Power	—	9 VA	9 VA	9 VA
Holding	3.0 Watts	4 VA (3.0 Watts)		

### System Pressurization and Depressurization Curves

(with Automatic Soft Start Device)

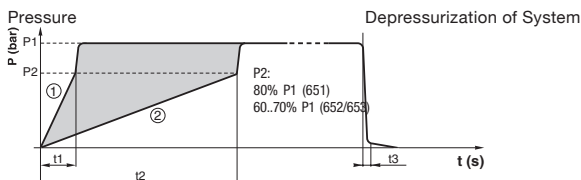

The adjustment range for the pressurization time lies between curves (1) and (2).

The transition to full flow takes place automatically as soon as the downstream pressure reaches 80% (651)/60% to 70% (652/653) P1 (not adjustable) and a downstream capacity of 10 liters.

Filling and venting times (seconds)			
	651 Series	652 Series	653 Series
t1 (with screw loosened by 6 (651)/7 (652)/8 (653) turns)	8.0	3.2	2.8
t2 (with screw loosened by 1 turn)	112.0	23.0	18.5
t3 (venting time)	4.8	1.0	0.5

These times correspond to a supply pressure (Pa) of 6.3 bar, a transition pressure (P2) of 80% (651)/60% to 70% (652/653) P1 (not adjustable) and a downstream capacity of 10 liters.

**How to Order - Slow Start/Quick Exhaust Valve**

**8 651 A 6 S 6 2 F A00 F1**

**Port Type**  
 8 = NPTF  
 1 G = ISO 228/1-G  
 J = ISO 7/1 Rc

**Product Series**  
 651  
 652  
 653

**Revision**  
 A

**Product Type**  
 4 = 2/2 - Slow Start  
 5 = 3/2 - Quick Exhaust  
 6 = 3/2 - Slow Start/Quick Exhaust

**Valve Type**  
 E = External Air Pilot  
 P = Internal Air Pilot (Available on 2/2 Slow Start only)  
 S = Solenoid Pilot

**Pilot Valve/Electrical Connection**  
 0 = No Electrical Connection  
 1 = Vertical Solenoid, without DIN Connector (651 or 652 only; must order with option 110)  
 2 = Vertical Solenoid, DIN Connector with LED (651 or 652 only; must order with option 110)  
 3 = Vertical Solenoid, DIN Connector w/o LED (651 or 652 only; must order with option 110)  
 2 4 = Vertical Solenoid, 3 Pin M12 Connection (651 or 652 only; must order with option 110)  
 5 = Horizontal Solenoid, without DIN Connector  
 6 = Horizontal Solenoid, DIN Connector with LED  
 7 = Horizontal Solenoid, DIN Connector without LED  
 2 8 = Horizontal Solenoid with 3 Pin M12 Connection  
 9 = Without Pilot Operator

**Port Size**  
 1 = 1/8 (651 Series)  
 2 = 1/4 (651 or 652 Series)  
 3 = 3/8 (652 Series)  
 4 = 1/2 (652 or 653 Series)  
 5 = 3/4 (653 Series)  
 6 = 1 (653 Series)

**Voltage**  
 FT = 115/50 VAC (653 only)  
 3 EW = 120/60, 115/50 VAC  
 F1 = 24 VDC  
 FQ = 24 50/60 VAC  
 FH = 230 50/60 VAC (651 or 652)  
 F8 = 230/50 VAC (653 only)  
 DE = 230/60 VAC (653 only)  
 00 = No Voltage

**Options**  
 A00 = No Options  
 101 = Side Mounting Brackets  
 109 = FKM Seals  
 110 = Without Manual Override  
 111 = Metal Muffler  
 112 = Polyethylene Muffler  
 113 = Stainless Steel Fasteners  
 5 117 = ATEX Zones 1-21   
 122 = Inverted Mounting  
 123 = Gauge Type Mounted for Right-to-Left Flow  
 201 = 110 + 111



**Gauge Type**  
 B = Digital Pressure Switch - PNP (Rated Pressure - 0-145 PSIG/0-10 bar)  
 C = Digital Pressure Switch - NPN (Rated Pressure - 0-145 PSIG/0-10 bar)  
 D = Digital Gauge (Rated Pressure - 0-145 PSIG/0-10 bar)  
 F = Low Profile Gauge PSI/bar  
 G = Low Profile Gauge bar/PSI  
 H = Low Profile Gauge PSI/bar with Pressure Range Indicator  
 J = Low Profile Gauge bar/PSI with Pressure Range Indicator  
 N = No Gauge with Port Plate (1/8 NPTF)  
 P = No Gauge with Port Plate (1/8 ISO 7/1 Rc)  
 Q = Round Gauge bar/PSI  
 R = Round Gauge PSI/bar  
 0 = No Gauge Port

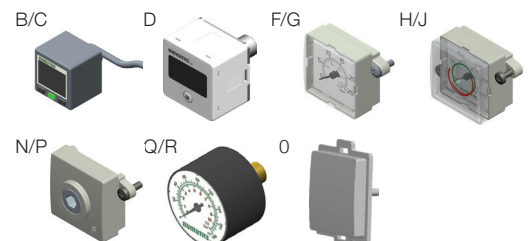

1 Conforms to ISO standards 1179-1  
 2 Available for 24 VDC voltage only  
 3 For 653 Series, voltage EW = 120/60 VAC only  
 4 If multiple options are required, please use the online CAD configurator on the website to generate the part number (www.asco.com), or consult factory  
 5 Option 117 (ATEX Zones 1-21) is available with Valve Type E or P. For Valve Type S (Solenoid Pilot), please select 9 under the Pilot Valve/Electrical Connection. Consult factory for further information

Dimensions: mm (inches) 651/652/653 Series Slow Start/Quick Exhaust Valve

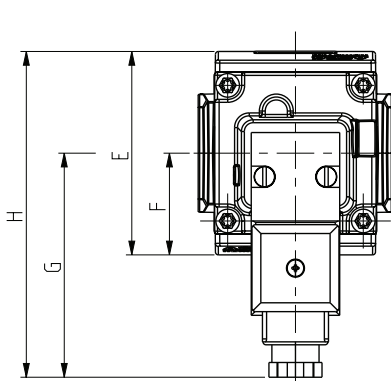

Cross Section -  
651/652/653 Series  
Slow Start/Quick  
Exhaust Valve

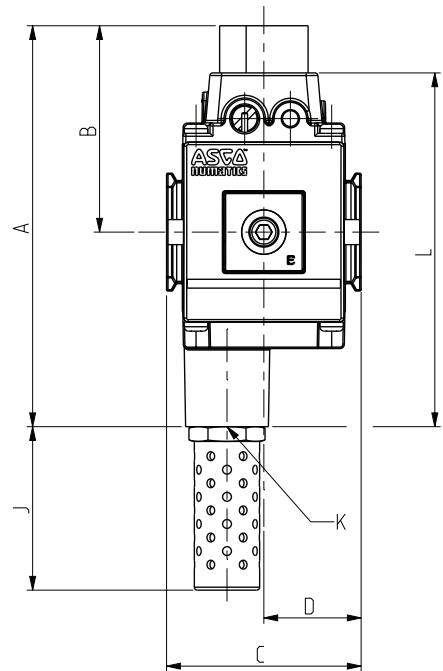
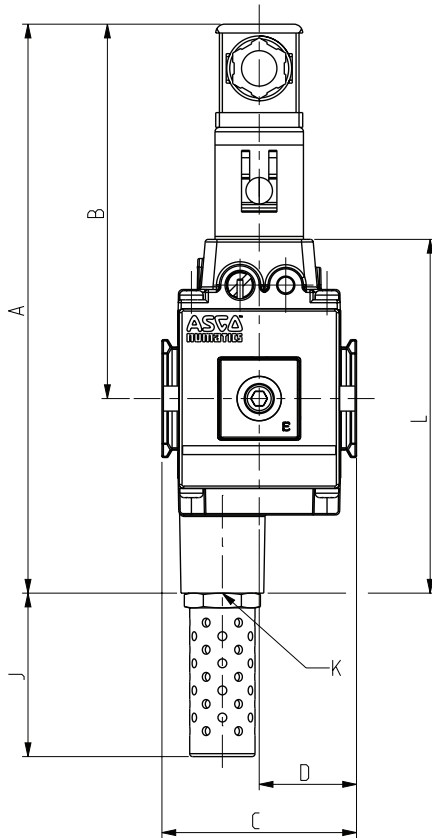
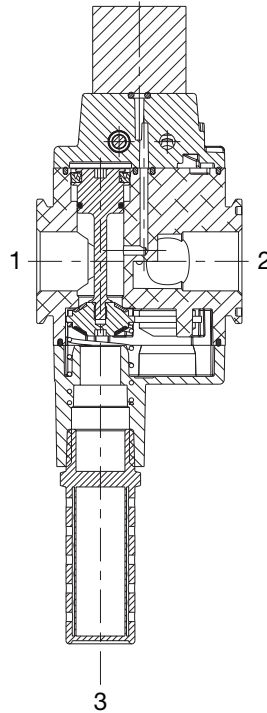
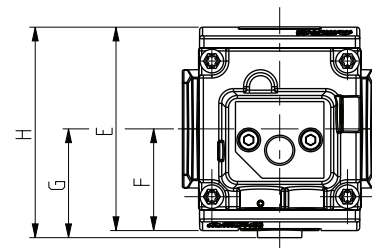

External Air Pilot

	A	B	C	D	E	F	G	H	J	K	L
<b>651</b>	113	59	50	25	58	29	31.5	60.5	34.5	1/4 NPTF or 1/4 ISO 228/1-G	97
	(4.45)	(2.32)	(1.97)	(0.98)	(2.28)	(1.14)	(1.24)	(2.38)	(1.36)		(3.82)
<b>652</b>	136	70	66	33	69	34.5	37	71.5	57	1/2 NPTF or 1/2 ISO 228/1-G	120
	(5.35)	(2.76)	(2.60)	(1.30)	(2.72)	(1.36)	(1.46)	(2.81)	(2.24)		(4.72)
<b>653</b>	158	81	90	45	93.1	46.5	48.4	95	81.2	1 NPTF or 1 ISO 228/1-G	142
	(6.22)	(3.19)	(3.54)	(1.77)	(3.67)	(1.83)	(1.91)	(3.74)	(3.20)		(5.59)

Solenoid Pilot

	A	B	C	D	E	F	G	H	J	K	L
<b>651</b>	170	116	50	25	58	29	72	101	34.5	1/4 NPTF or 1/4 ISO 228/1-G	97
	(6.69)	(4.57)	(1.97)	(0.98)	(2.28)	(1.14)	(2.83)	(3.98)	(1.36)		(3.82)
<b>652</b>	193	127	66	33	69	34.5	72	106.5	57	1/2 NPTF or 1/2 ISO 228/1-G	120
	(7.60)	(5.00)	(2.60)	(1.30)	(2.72)	(1.36)	(2.83)	(4.19)	(2.24)		(4.72)
<b>653</b>	214	137	90	45	93.1	46.5	94	140.5	81.2	1 NPTF or 1 ISO 228/1-G	142
	(8.43)	(5.39)	(3.54)	(1.77)	(3.67)	(1.83)	(3.70)	(5.53)	(3.20)		(5.59)

## DIVERTER BLOCK

- Ideal for branching off primary series air prep manifold to add additional products, such as adding another regulator or dividing lubricated and un-lubricated compressed air lines
- 1/8 or pad mount interface ports on top of product for adding pressure switches/sensors or other condition monitoring devices
- 1/4 ports (651 Series), 3/8 ports (652 Series), or 3/4 ports (653 Series) on the front and back provide additional flexibility to attach or branch off the main manifold. It can also be used to feed auxiliary air to air prep assemblies that require additional air capacity, such as a bank of manifold regulators

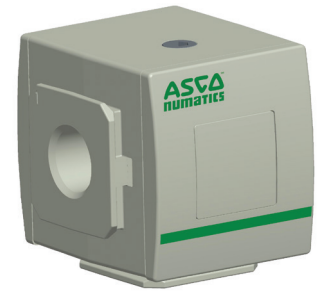

Performance Data				
Series		651	652	653
Port Sizes	Left, Right & Bottom	1/4 & Flanged	1/2 & Flanged	1 & Flanged
	Front & Back**	1/4	3/8	3/4
Thread Type		NPTF, G & Rc		
Top Port (for Pressure Switch/Pressure Sensor)		1/8*		
Maximum Pressure PSIG (bar)		232 (16)		290 (20)
Fluid		Air or Inert Gas		
Weight lbs. (kg)		0.41 (0.188)	0.73 (0.331)	1.67 (0.753)

\* Different for EU

\*\* To access front & back ports remove covers and plugs

Materials in Contact with Fluid	
Body	Aluminum

## How to Order

### Diverter Block

8 651 A D 0 0 2 T A00 0 0

#### Port Type

- 8 = NPTF
- <sup>1</sup>G = ISO 228/1-G
- J = ISO 7/1 Rc

#### Product Series

- 651
- 652
- 653

#### Revision

A

#### Product Type

- D = Diverter Block

#### Options

- A00 = No Options
- 101 = Side Mounting Brackets
- 117 = ATEX Zones 1-21

#### Pressure Switch Interface

- C = Pad Mount (Europe only)
- T = 1/8 (US only)

#### Port Size

- 2 = 1/4 (651 Series)
- 4 = 1/2 (652 Series)
- 6 = 1 (653 Series)

1 Conforms to ISO standards 1179-1

2 If multiple options are required, please use the online CAD configurator on the website to generate the part number ([www.asco.com](http://www.asco.com)), or consult factory

Dimensions: mm (inches) 651/652/653 Series Diverter Block

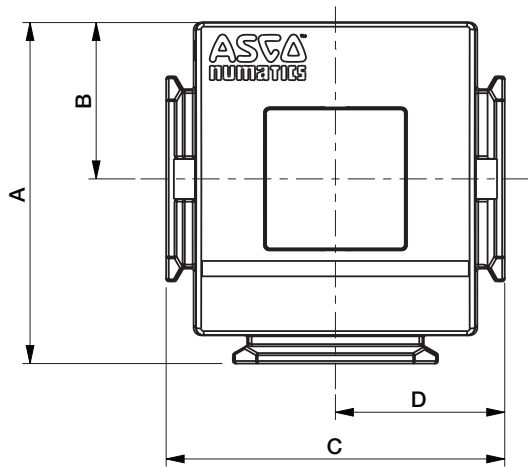
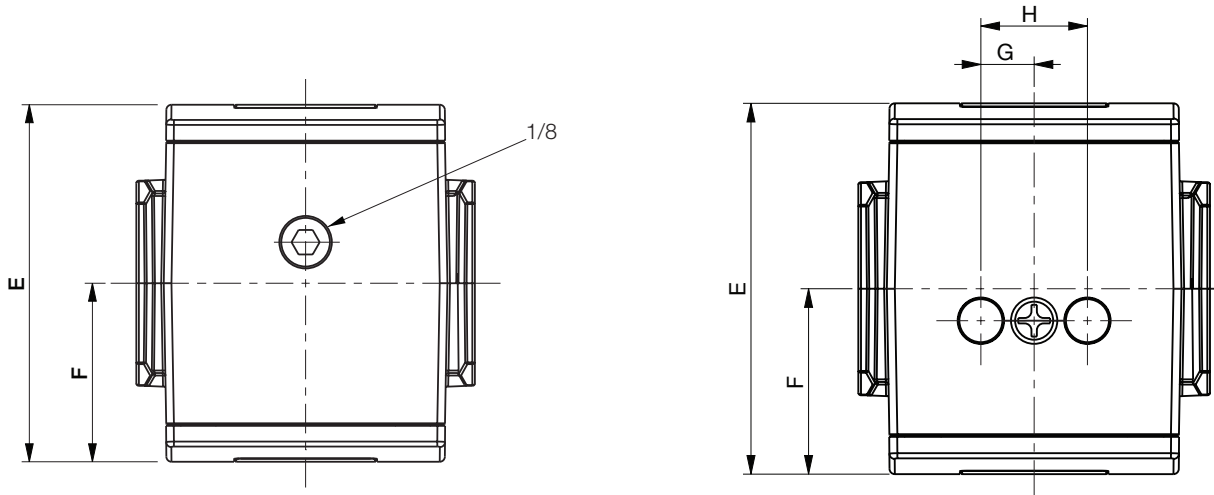

Cross Section -  
651/652/653 Series  
Diverter Block

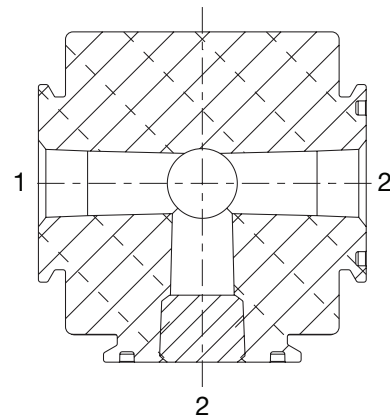

	A	B	C	D	E	F	G	H
<b>651</b>	54.4	25	50	25	58	29	10	20
	(2.14)	(0.98)	(1.97)	(0.98)	(2.28)	(1.14)	(0.39)	(0.79)
<b>652</b>	66.5	30.5	66	33	70	35	10	20
	(2.62)	(1.20)	(2.60)	(1.30)	(2.76)	(1.38)	(0.39)	(0.79)
<b>653</b>	89.5	41	90	45	93	46.5	10	20
	(3.52)	(1.61)	(3.54)	(1.77)	(3.66)	(1.83)	(0.39)	(0.79)

## LOCKOUT VALVE

- Modular assembly to 652 or 653 series manifold using common Body-to-Body clamps
- Provides high exhaust capacity of downstream pressure
- Available as Full Flow Start or Slow Start
- Slow Start feature allows operator to turn knob counter clock wise to “On” position, gradually ramping up downstream pressure
- Bright yellow body with red knob is easily identified as an emergency shut off device
- Typically located as the final component in an Air Preparation assembly

Performance Data				
Series	652		653	
Port Sizes*	1/2		1	
Nominal Flow	1 → 2	2 → 3	1 → 2	2 → 3
	SCFM (L/min ANR)	116 (5905)	116 (5905)	347 (9850)
Ambient Temperature Range °F (°C)	40 to 120 (4 to 50)			
Fluid Temperature Range °F (°C)	40 to 120 (4 to 50)			
Maximum Pressure PSIG (bar)	150 (10.3)		246 (17.0)	
Fluid	Air or Inert Gas			
Weight lbs. (kg)	Standard	2.71 (1.23)	6.37 (2.89)	
	Slow Start	3.06 (1.39)	7.12 (3.23)	

\*Ports are not threaded (grey flanges). Easily connect to 652 or 653 Series Manifold. When connecting to pipe, use end plate kits on page 52.

Materials in Contact with Fluid	
Body	Aluminum
Seals	NBR
Spool	Aluminum

## How to Order Lockout Valve

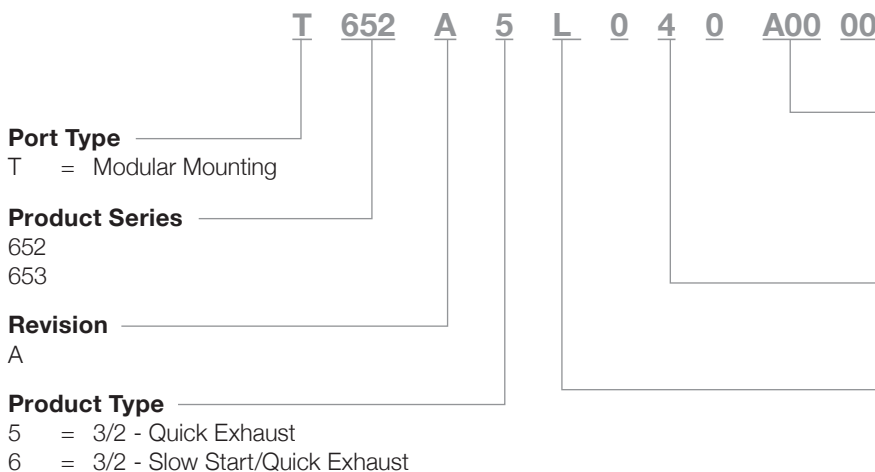

\* If multiple options are required, please use the online CAD configurator on the website to generate the part number ([www.asco.com](http://www.asco.com)), or consult factory.

## 3/2 Lockout Valve with Slow Start Feature

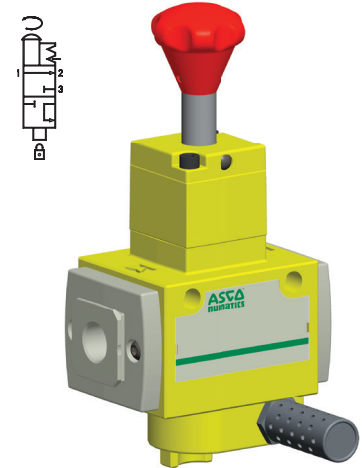

## 3/2 Lockout Valve





Dimensions: mm (inches) 652/653 Series Lockout Valve

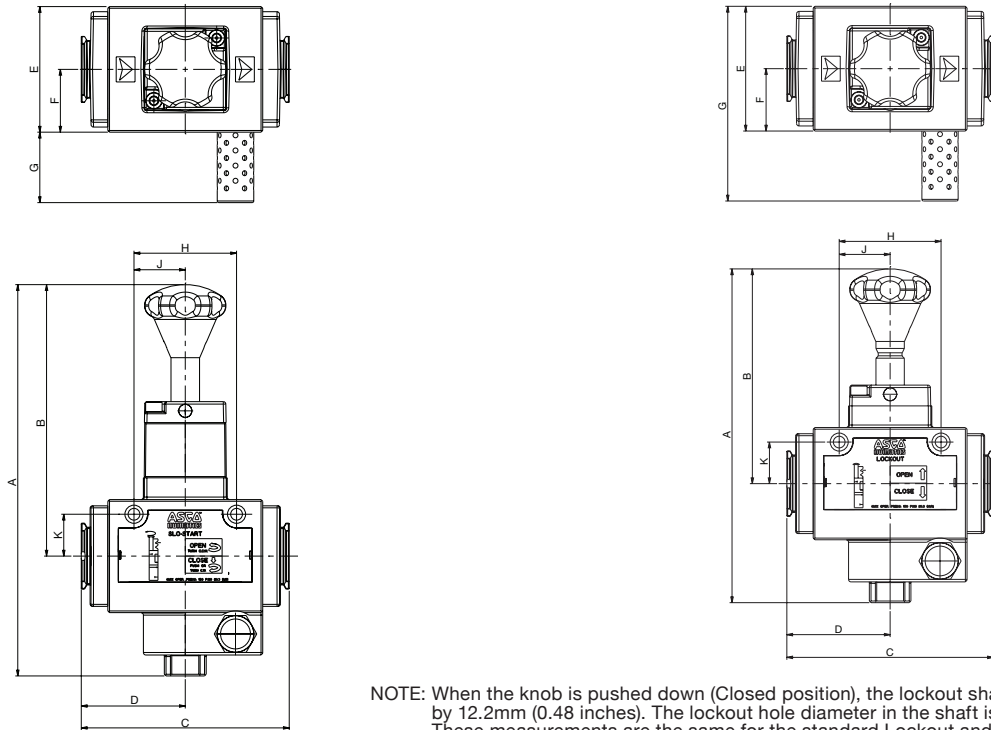

NOTE: When the knob is pushed down (Closed position), the lockout shaft extends out of the bottom by 12.2mm (0.48 inches). The lockout hole diameter in the shaft is 11.2mm (0.44 inches). These measurements are the same for the standard Lockout and the Slow Start version.

3/2 Lockout Valve with Slow Start Feature

	A	B	C	D	E
<b>652</b>	237.5	164.9	126.2	63.1	76.2
	(9.35)	(6.49)	(4.97)	(2.48)	(3.00)
<b>653</b>	291	198.8	150.5	75.3	101.6
	(11.46)	(7.83)	(5.93)	(2.96)	(4.00)

	F	G	H	J	K
<b>652</b>	38.1	42.7	62.2	31.1	25.4
	(1.50)	(1.68)	(2.45)	(1.22)	(1.00)
<b>653</b>	50.8	77.3	82.8	41.4	27.9
	(2.00)	(3.04)	(3.26)	(1.63)	(1.10)

3/2 Lockout Valve

	A	B	C	D	E
<b>652</b>	204	131.3	126.2	63.1	76.2
	(8.03)	(5.17)	(4.97)	(2.48)	(3.00)
<b>653</b>	247.8	155.6	150.5	75.3	101.6
	(9.76)	(6.13)	(5.93)	(2.96)	(4.00)

	F	G	H	J	K
<b>652</b>	38.1	119	62.2	31.1	25.4
	(1.50)	(4.69)	(2.45)	(1.22)	(1.00)
<b>653</b>	50.8	178.9	82.8	41.4	27.9
	(2.00)	(7.04)	(3.26)	(1.63)	(1.10)

3/2 Lockout Valve with Slow Start Feature  
Cross Section

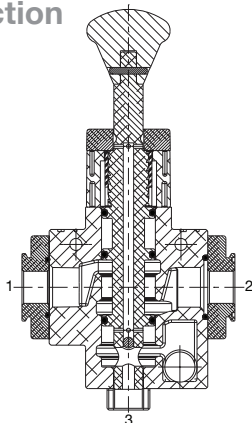

3/2 Lockout Valve Cross Section

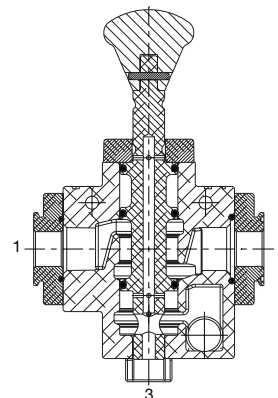

## AIR PREPARATION MANIFOLD ASSEMBLIES

### How to Order - Air Preparation Manifold Assemblies

**8 651 A S L D 2 C 0 0 A00**

**Port Type**

- 8 = NPTF
- G = ISO 228/1-G
- J = ISO 7/1 Rc

**Product Series**

- 651
- 652
- 653

**Revision**

- A

**Product Type**

- S = FRL Assembly

**Air Flow Direction**

- L = Configure Air Flow P(1) Left - P(2) Right
- R = Configure Air Flow P(1) Right - P(2) Left

**Number of Stations**

A = 1	K = 11
B = 2	L = 12
C = 3	M = 13
D = 4	N = 14
E = 5	O = 15
F = 6	P = 16
G = 7	Q = 17
H = 8	R = 18
I = 9	S = 19
J = 10	T = 20

**Options**

- A00 = No Options
- 117 = ATEX Zones 1-21

**Mounting Type**

- 0 = No Mounting
- C = End Plates, Body-to-Body Assembly Clamps & Wall/Panel Brackets
- F = End Plates and Body-to-Body Assembly Clamps
- L = Side Mounting Brackets

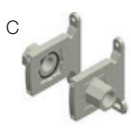

C

L (651/652)

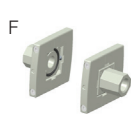

F

L (653)



**End Plate Port Size**

- 0 = None
- 2 = 1/4 (651 Series)
- 4 = 1/2 (652 Series)
- 6 = 1 (653 Series)
- 7 = 1-1/4 (653 Series)

1 Conforms to ISO standards 1179-1

All manifolds come assembled and fully tested to your configuration.

If additional support is required in the middle of a manifold. Please specify kit number P699AT502467001. This kit contains one Wall/Panel Bracket (also referred to as support bracket or mounting bracket). This bracket can be installed at the factory or ordered separately as a kit. This kit contains two screws, which allows customers to easily attach the bracket to the back of any of the Body-to-Body clamps in the manifold assembly.

After selecting the top level assembly part number, please refer to each of the How to Order charts within this catalog to determine the specific product that is required in the manifold assembly. The How to Order charts are located on the following pages:

Particulate Filter	Page 4	Lubricator	Page 27
Coalescing Filter	Page 8	Shut Off Isolation Valve	Page 30
Regulator	Page 12	Slow Start/Quick Exhaust Valve	Page 33
Manifold Regulator	Page 16	Diverter Block	Page 36
Particulate Filter/Regulator	Page 19	Lockout Valve	Page 38
Coalescing Filter/Regulator	Page 23		

How to Order - 651/652 Series Air Preparation Manifold Assemblies

Example #1

The following example assembly includes six stations of the 652 series products, manifold end plates with mounting brackets and an additional support bracket between station 1 and 2. The manifold air flow is from Left-to-Right. Port type is NPTF. Port size is 1/2.

The regulator is configured for a bottom oriented pressure adjustment (option 122). The Shut Off Isolation Valve is configured with a Low Profile Gauge, with pressure range indicators.

Example Order

<b>Assembly</b>	<b>8652ASLF4C00A00</b>	<b>652 Series Air Prep Assembly</b>
Station #1	8652A3M04H11100	652 Series Shut Off Isolation Valve
	P699AT502467001	Support Bracket
Station #2	8652ABBP4JA000N	652 Series Particulate Filter
Station #3	8652AFDM4FA000A	652 Series Coalescing Filter
Station #4	8652AR004F122G0	652 Series Regulator
Station #5	8652AD004TA0000	652 Series Diverter Block
Station #6	8652A6S74FA00F1	652 Series Slow Start/Quick Exhaust Solenoid Valve
	Assembled	

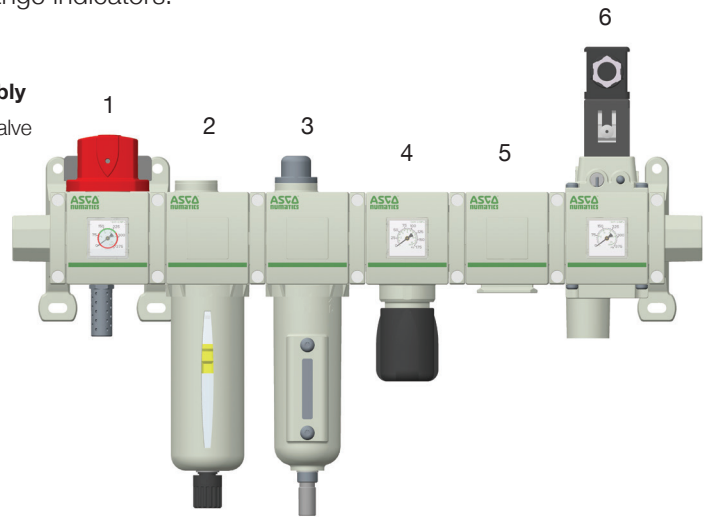

Example #2

The following example assembly includes five stations of the 651 series products and side mounting brackets. The manifold air flow is from Right-to-Left. Port type is ISO 228/1-G. Port size is 1/4.

The Lubricator is configured with an Electronic Liquid Level Indicator (option 108). The Shut Off Isolation Valve uses a combination option (270), which is configured when you use a Metal Muffler (111) and a Low Profile Gauge that requires a Right-to-Left flow (123). The Coalescing Filter/Regulator also uses a combination option. In this case, a combination option (243) includes a Key Lockable Handle (104) and a Low Profile Gauge that requires a Right-to-Left flow (123).

Example Order

<b>Assembly</b>	<b>G651ASRE0L00A00</b>	<b>651 Series Air Prep Assembly</b>
Station #5	G651AL0M2010800	651 Series Lubricator
Station #4	G651AD002TA0000	651 Series Diverter Block
Station #3	G651ACDM2F243GA	651 Series Coalescing Filter-Regulator
Station #2	G651ABBM2JA000A	651 Series Particulate Filter
Station #1	G651A3M02F27000	651 Series Shut Off Isolation Valve
	Assembled	

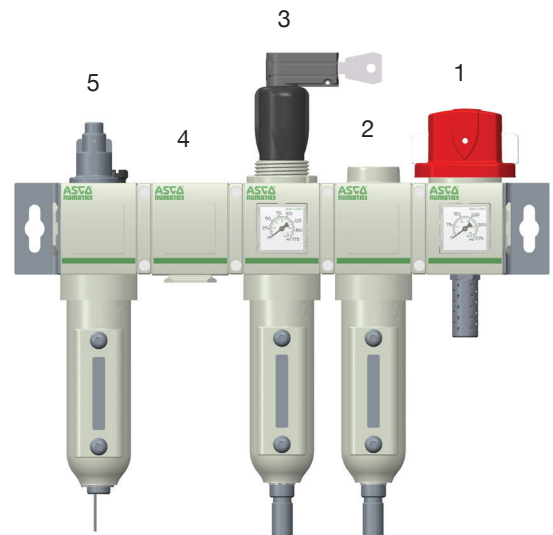

If multiple options are required, please use the online CAD configurator on the website to generate the part number ([www.asco.com](http://www.asco.com)), or consult factory.

**MOUNTING BRACKETS**

**Mounting Options**

**651 Series Side Mounting Brackets Kit#: P651AT503860001**  
**652 Series Side Mounting Brackets Kit#: P652AT503860002**  
**653 Series Side Mounting Brackets Kit#: P653AT503860003**

**651/652 Series**

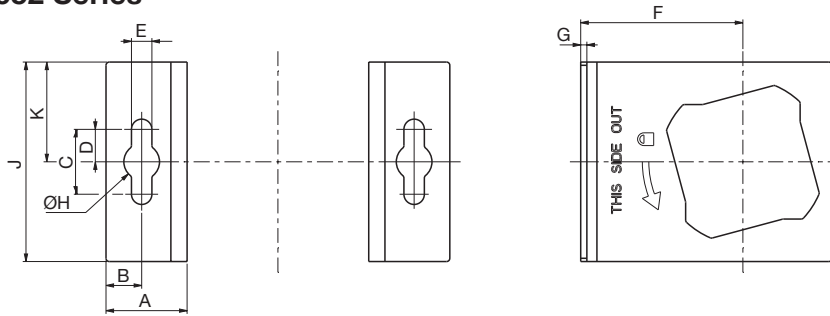

**653 Series**

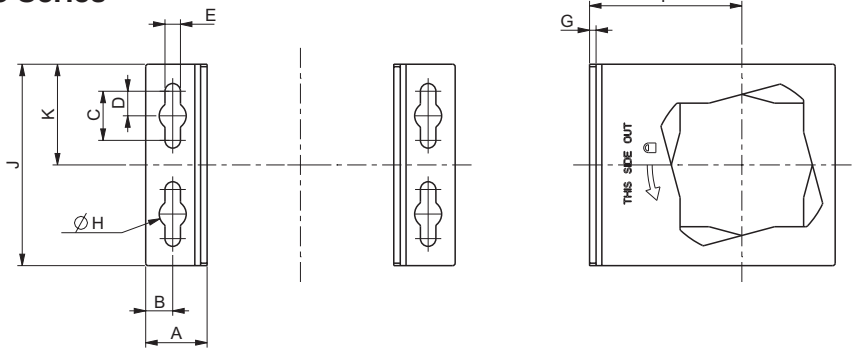

	A	B	C	D	E
<b>651</b>	25	11	20	10	6.3
	(0.98)	(0.43)	(0.79)	(0.39)	(0.25)
<b>652</b>	25	11	20	10	6.3
	(0.98)	(0.43)	(0.79)	(0.39)	(0.25)
<b>653</b>	25	11	20	10	6.3
	(0.98)	(0.43)	(0.79)	(0.39)	(0.25)

	F	G	ØH	J	K
<b>651</b>	44.5	1.3	11	50	25
	(1.75)	(0.05)	(0.43)	(1.97)	(0.98)
<b>652</b>	50	1.9	11	61.5	30.8
	(1.97)	(0.07)	(0.43)	(2.42)	(1.21)
<b>653</b>	62	2.65	11	82	41
	(2.44)	(0.10)	(0.43)	(3.23)	(1.61)

**Wall/Panel Bracket Kit#: P699AT502467001**

A	B	C	D	E	F
26	13	92	46	6	3
(1.02)	(0.51)	(3.62)	(1.81)	(0.24)	(0.12)

G	ØH	J	K	L	M
6.5	6.5	8	18	109	44.5
(0.26)	(0.26)	(0.31)	(0.71)	(4.29)	(1.75)

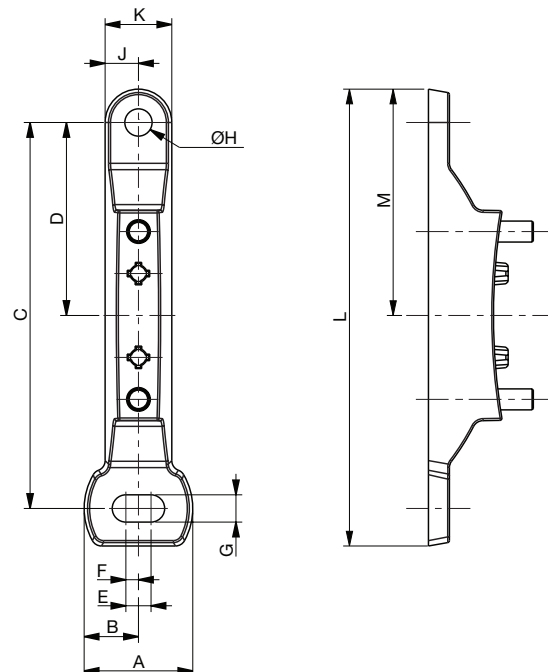

**BOWLS**

**Bowl and Drain Options**

**Polycarbonate Bowl/Guard with Semi-automatic/Manual Drain**

**Polycarbonate Bowl/Guard with Stainless Steel Manual Drain**

**Metal Bowl with Automatic Drain**

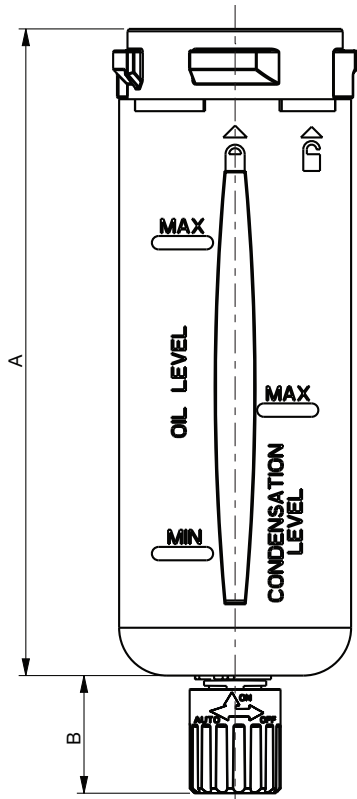

Drain Port: 1/8 ISO 228/1-G

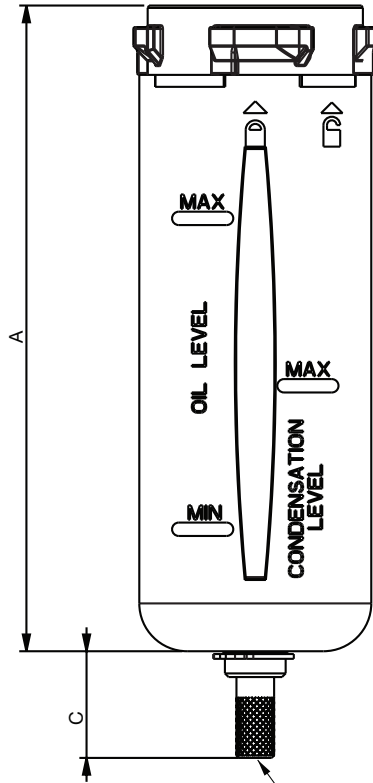

Drain Port: 10-32 UNF

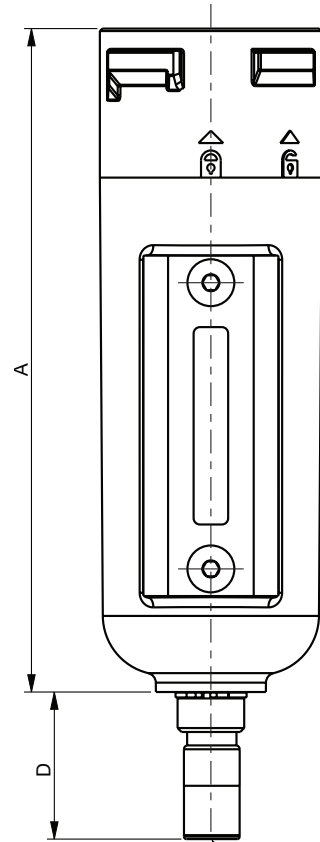

Drain Port: 1/8 ISO 228/1-G

	A	B	C	D
<b>651</b>	116	25	22.3	30
	(4.57)	(0.98)	(0.88)	(1.18)
<b>652</b>	135	25	22.3	30
	(5.31)	(0.98)	(0.88)	(1.18)
<b>653</b>	155.4	25	22.3	30
	(6.12)	(0.98)	(0.88)	(1.18)

Please allow the following clearance for bowl removal - mm (inch):

	651	652	653
Particulate Filter or Filter/Reg (from bottom of drain)	44 (1.8)	75 (3.0)	100 (4.0)
Coalescing Filter or Filter/Reg (from bottom of drain)	60 (2.4)	80 (3.2)	105 (4.2)
Coalescing Filter - High Flow (from bottom of drain)	-	-	125 (4.9)
Lubricator (from bottom of bowl)	20 (0.8)	25 (1.0)	25 (1.0)

Bowl Type	Series	Filter - Max Condensate Level (ml)				Lubricator - Max Oil Level (ml)	
		Semi/Manual	Manual	Automatic	No Drain	No Option	w/Liquid Level Indicator
Polycarbonate	651	30	30	15	30	45	35
	652	50	50	35	50	90	80
	653	80	80	65	80	200	190
Aluminum	651	30	30	15	30	45	35
	652	50	50	35	50	90	80
	653	80	80	65	80	200	190

## 280 SERIES DIGITAL PRESSURE SWITCH

Performance Data		
Port Size/Thread Type	1/8 NPTF Male x 10/32 UNF Female	
	1/8 ISO 7/1 Rc Male x M5-0.8 Female	
Ambient Temperature Range °F (°C)	32 to 122 (0 to 50)	
Rated Pressure Range PSIG (bar)	0 to 145 (0 to 10)	
Maximum Pressure PSIG (bar)	217.5 (15)	
Fluid	Air or Inert Gas	
Set Pressure Resolution	kPa	1
	kgf/cm <sup>2</sup>	0.01
	bar	0.01
	PSI	0.1
LCD Display	7 Segment; Red/Green Color	
Sampling Rate	5 times per second	
Repeatability	≤ +/- 0.2% F.S. +/- 1 Digit	
Hysteresis (window comparator mode)	Adjustable	

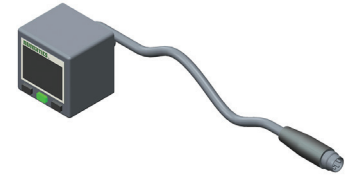

Electrical Ratings	
Power Supply Voltage	12 to 24 VDC +/- 10% Ripple (P-P) 10% or Less
Current Consumption	≤ 45 mA (with no load)
Switch Output	PNP Open Collector / NPN Open Collector
Max. Load Current	125 mA      125 mA
Max Supply Voltage	24 VDC      30 VDC
Residual Voltage	≤ 1.5 V      ≤ 1.5 V
Load Current	125 mA      125 mA
Enclosure Rating	IP40

Materials in Contact with Fluid	
Enclosure Case	PBT + 30 GF
Port	Nickel Plated Brass
Seals	NBR

### How to Order

#### Model Numbers

DPS280PNQ8 1/8 NPTF (PNP)  
DPS280NNQ8 1/8 NPTF (NPN)

DPS280PRQ8 1/8 ISO 7/1 Rc (PNP)  
DPS280NRQ8 1/8 ISO 7/1 Rc (NPN)

Note: All part numbers include an 8mm Pico 4 Pin connector and 2 meter cable (4mm O.D. x 24 AWG)

### Display Panel Instructions

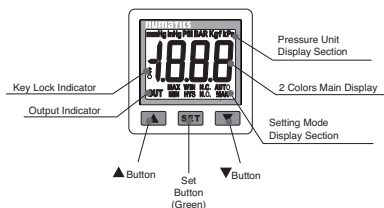

### Switch Wiring

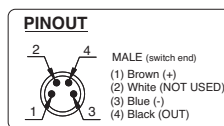

### Output Circuit Wiring

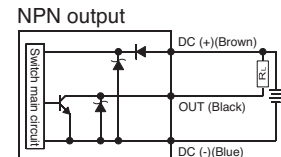
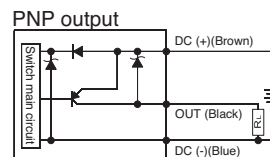

### Accessory Numbers

Model	Accessory Description
DPS280-8-4-ST-2	Mating Cable 8mm 4 Pin 2 Meter
DPS280-8-4-ST-5	Mating Cable 8mm 4 Pin 5 Meter
PC0402MEETA03000	Patch Cable M8 4 Pin X M12 3 Pin 2 Meter

Model	Accessory Description
PMK280-C	Panel Mount Kit with Cover

PS182 SERIES PRESSURE SWITCH

Performance Data	
Port Size/Thread Type	1/8 NPTF or 1/8 ISO 228/1-G (BSPP)
Ambient Temperature Range °F (°C)	-40 to 250 (-40 to 121)
Set Point Adjustment Ranges PSI (bar)	2–10 (0.14 to 0.69), 6–30 (0.41 to 2.07), 20–130 (1.38 to 8.96)
Set Point Tolerance	+ 1 PSI or 5%
Maximum Pressure PSIG (bar)	600 (41.4)
Fluid	Air or Inert Gas
Maximum Cycle Rate per Minute	200
Hysteresis Adjustment	10%

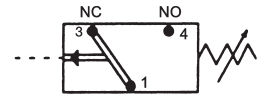

Electrical Ratings	
Switch Contact Rating	4 Amp (Gold Plated Contacts)
Voltage Range	12 VDC to 250 VDC
Enclosure Rating	IP65
Electrical Connection	3 Pin M12

Materials in Contact with Fluid	
Enclosure Case	Anodized Aluminum
Body	Brass
Seals	NBR

How to Order

Model Numbers

- PS182CAN01-2 1/8 NPTF (Pin out is compatible with G3 Fieldbus Digital I/O)
- PS182CAN01 1/8 NPTF
- PS182CAG01 1/8 ISO 228/1-G (BSPP)

PS182 Series Pressure Switch

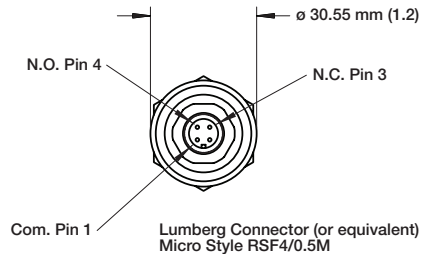
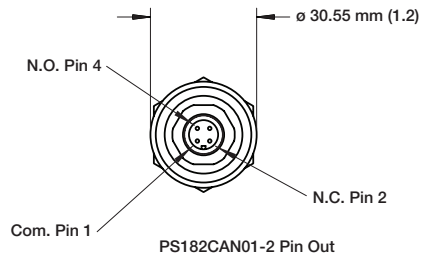
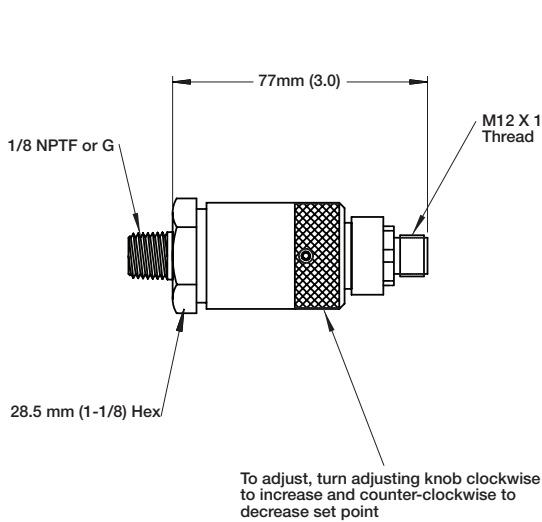

**PS180 SERIES PRESSURE SWITCH/ DIGITAL PRESSURE GAUGE**

Performance Data	
Port Size/Thread Type	1/8 NPTF & ISO 228/1-G (BSPP)
Ambient Temperature Range °F (°C)	0 to 190 (-15 to 85)
Set Point Adjustment Ranges PSI (bar)	4–20 (0.28 to 1.38), 14–150 (0.97 to 10.34)
Maximum Pressure PSIG (bar)	300 (20.7)
Fluid	Air or Inert Gas
Maximum Cycle Rate per Minute	200
Hysteresis Adjustment	15%

Electrical Ratings	
Switch Contact Rating	4 Amp
Maximum Voltage	250 VAC (200 VDC)
Enclosure Rating	IP65

Materials in Contact with Fluid	
Connector Housing	Polyamide
Port	Zinc Plated Steel
Seals	NBR

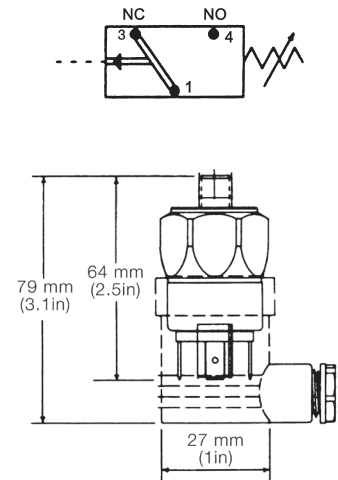

**How to Order**

**Model Numbers**

- PS180CAN01     1/8 NPTF
- PS180CAG01     1/8 ISO 228/1-G

**Digital Pressure Gauge**

Performance Data	
Port Size/Thread Type	1/8 (NPTF or ISO 7/1 Rc)
Ambient Temperature Range °F (°C)	32 to 122 (0 to 50)
Rated Pressure Range PSIG (bar)	0 to 145 (0 to 10)
Maximum Pressure PSIG (bar)	217.5 (15)
Fluid	Air or Inert Gas
Display (Unit Measurement)	PSI, bar, Mpa, kgf/cm <sup>2</sup>
LCD Display	7 Segment 3-1/2 Digit
Sampling Rate	2 times per second
Repeatability	< + 0.2% + 1 Digit

Electrical Ratings	
Battery	CR 2032 Lithium (Replaceable)
Battery Life	3 Year (display turned on 5 times per day)
Battery Power Saving Mode	Display turns off after 30 seconds
Enclosure Rating	IP65

Materials in Contact with Fluid	
Enclosure - Front Case	ABS
Enclosure - Back Case	Zinc
Seals	NBR



**How to Order**

**Model Numbers**

- M699AG504650001     1/8 NPTF
- M699AG504650002     1/8 ISO 7/1 Rc



### 349 SERIES PRESSURE SWITCH

Performance Data		
	Without Protection	With Protection
Port Size/Thread Type	Pad Mounted	
Fluid	Air or Inert Gas	
Pressure Setting	0.2 to 6, 0.5 to 10, 0.5 to 16 bar	
Hysteresis	0.4 bar at the beginning of adjustment range 1 bar at the end of adjustment range	
Operating Temperature (°C)	-10 to 60	0 to 60
Max Voltage	250V - AC/DC	24 VDC
Current Breaking Capacity	5A - 250V resistive	2A - 24Vcc Resistive
Protection Degree	IP65	
Max Speed	60 cycles per minute	

Material in contact with fluid	
Body	High Performance Polymer(PA61/XT)/Aluminium for 16 bar version
Seals	NBR

### How to Order

	0.2-6 bar	0.5-10 bar	0.5-16 bar
With Protection	34900028	34900031	34900034
Without Protection	34900027	34900030	34900033

### Dimensional Drawings

#### Without Protection

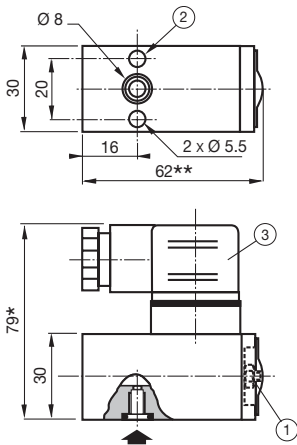

- ① Pressure set screw (spanner for hexagon nuts: 3mm)
- ② 2 holes Ø 5.5 for mounting
- ③ ISO4400 size 30 connector, 4 terminals, rotatable by 90°

\* 15mm for connector clearance  
\*\* +2mm for 0.5 - 16 bar version

#### With Protection

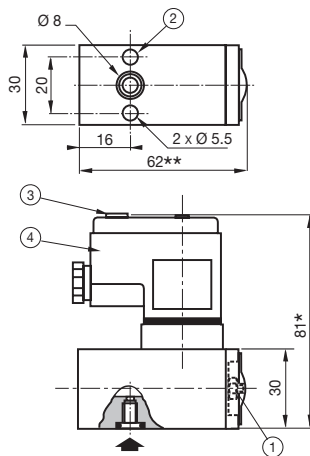

- ① Pressure set screw (spanner for hexagon nuts: 3mm)
- ② 2 holes Ø 5.5 for mounting
- ③ Identification label holder
- ④ ISO 4400 size 30 connector, 4 terminals, non-rotatable

\* 15mm for connector clearance  
\*\* +2mm for 0.5 - 16 bar version

### With Protection Electrical Diagram

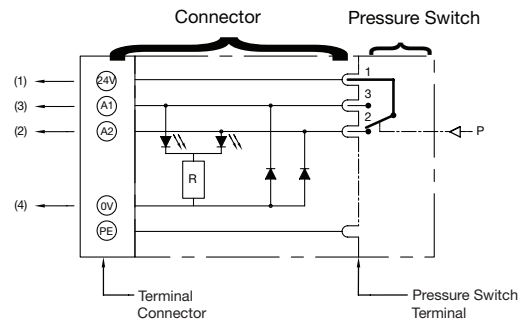

#### Status indicated by two diodes:

- at rest: contact 1-2 made: orange diode lights
- at work: contact 1-3 made: red diode lights

Terminal connection for 1.5mm<sup>2</sup> wire integrated interference blinking

### Electrical Connection With and Without Protection

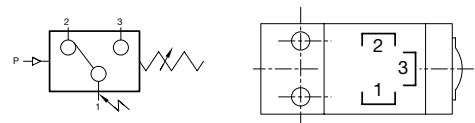

**ELECTRIC DIFFERENTIAL PRESSURE INDICATOR/  
ELECTRONIC LIQUID LEVEL INDICATOR**

**Electric Differential Pressure Indicator**

Performance Data	
Ambient Temperature Range °F (°C)	-13 to 212 (-25 to 100)
Maximum Pressure PSIG (bar)	290 (20)
Delta P Setting +PSIG (bar)	10.2 (0.7)

Electrical Ratings	
Switching Contact	SPDT
14 VDC/5 A; 30 VDC/4 A; 125 VAC/5 A; 250 VAC/5 A	
Minimum Load	5 VDC/160 mA
Enclosure Rating	IP65 (DIN Connector 43650)

Materials in Contact with Fluid	
Body	Brass
Seals	NBR

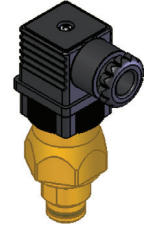

**How to Order**

**Model Numbers**

M699AG439851003

**Electronic Liquid Level Indicator (for Lubricator)**

Performance Data	
Actuation Point	25 mL (Nominal)
Switch Contact is open when fluid drops below 25 mL	
Connection	1/8-27 NPT External Thread

Electrical Ratings	
Switching Contact	SPST
Switch Type	50 Watt Reed Switch
Wire Size/Length	22 AWG/24 Inches (610mm)

Materials in Contact with Fluid	
Body	Brass
Float	Nylon











**How to Order**

**Model Numbers**







M699AG506837001

**Repair Kits and Service Parts - Spare Parts Kits**









		Description	Series	Kit Number
<b>Bowls*</b>		Polycarbonate Bowl & Bowl Guard - Includes NBR Bowl Seal for Filters, Filter-Regulators and Lubricators (Electronic Liquid Level Indicator only)	651	M651AU434133001
			652	M652AU440511001
			653	M653AU507439001
		Polycarbonate Bowl (No Bowl Guard) - Includes NBR Bowl Seal for Filters, Filter-Regulators and Lubricators (Electronic Liquid Level Indicator only)	651	M651AU434133009
		Polycarbonate Bowl & Bowl Guard - Includes NBR Bowl Seal for Lubricators	651	M651AU434133008
			652	M652AU440511008
			653	M653AU507439006
		Polycarbonate Bowl (No Bowl Guard) - Includes NBR Bowl Seal for Lubricators	651	M651AU434133010
		Metal bowl without sight gauge. Includes NBR Bowl Seal	651	M651AU434133002
			652	M652AU440511002
			653	M653AU507439002
		Metal bowl without sight gauge. Includes FKM Bowl Seal	651	M651AU434133011
			652	M652AU440511011
			653	M653AU507439005
		Metal bowl with polyamide sight gauge. Includes NBR Bowl Seal	651	M651AU434133003
			652	M652AU440511003
			653	M653AU507439003
		Metal bowl with polyamide sight gauge. Includes FKM Bowl Seal	651	M651AU434133013
		652	M652AU440511013	
		653	M653AU507439011	
	Metal bowl with borosilicate (glass) sight gauge. Includes NBR Bowl Seal	651	M651AU434133004	
		652	M652AU440511004	
		653	M653AU507439004	
	Metal bowl with borosilicate (glass) sight gauge. Includes FKM Bowl Seal	651	M651AU434133015	
		652	M652AU440511015	
		653	M653AU507439013	
<b>High Pressure Bowls</b>		Metal bowl without sight gauge. Includes NBR Bowl Seal.	653	M653AU507439002
		Metal bowl without sight gauge. Includes FKM Bowl Seal.	653	M653AU507439005
		Metal bowl with polyamide sight gauge. Includes NBR Bowl Seal.	653	M653AU507439003
		Metal bowl with polyamide sight gauge. Includes FKM Bowl Seal.	653	M653AU507439011
		Metal bowl with borosilicate (glass) sight gauge. Includes NBR Bowl Seal.	653	M653AU507439004
		Metal bowl with borosilicate (glass) sight gauge. Includes FKM Bowl Seal.	653	M653AU507439013
		Metal bowl without sight gauge. Includes NBR Bowl Seal.	653	M653AU523308001
		Metal bowl without sight gauge. Includes FKM Bowl Seal.	653	M653AU523308002

\* For lubricator replacement metal bowls, please also order bowl plug p/n M699AQ440512001. This is not required if the Electronic Liquid Level Indicator is used.

**Repair Kits and Service Parts - Spare Parts Kits**

		<b>Description</b>	<b>Series</b>	<b>Kit Number</b>
<b>Drains</b>		Drain Plug Assembly. Provides an option to customers that do not want to use a bowl drain. Includes NBR Bowl Seal.	<b>651</b> <b>652</b> <b>653</b>	M699AQ440512001
		Semi-automatic/Manual Drain Assembly - with NBR seals. This normally open drain can be used as a manual drain or set to semi-automatic, which will drain the bowl upon a loss of system pressure. Drain material is plastic.	<b>651</b> <b>652</b> <b>653</b>	M699AQ440512002
		Semi-automatic/Manual Drain Assembly - with FKM seals. This normally open drain can be used as a manual drain or set to semi-automatic, which will drain the bowl upon a loss of system pressure. Drain material is plastic.	<b>651</b> <b>652</b> <b>653</b>	M699AQ440512007
		Manual Stainless Steel Drain Assembly - with NBR seals. Provides the user with an alternative to the plastic semi-automatic drain.	<b>651</b> <b>652</b> <b>653</b>	M699AQ440512003
		Manual Stainless Steel Drain Assembly - with FKM seals. Provides the user with an alternative to the plastic semi-automatic drain.	<b>651</b> <b>652</b> <b>653</b>	M699AQ440512008
		Automatic Drain Assembly - with NBR seals. This drain uses a float that initiates the bowl to drain when the liquid rises. In addition, all fluid will drain when the pressure drops below 22 PSI. Drain material is brass. This drain can also be operated manually.	<b>651</b> <b>652</b> <b>653</b>	M699AQ501862001
<b>Bowl &amp; Drain Assembly</b>		Bowl and Drain Assembly - Includes Polycarbonate Bowl/Guard and Semi-automatic Drain Assembly (NBR Seals).	<b>651</b>	M651AU514009001
			<b>652</b>	M652AU513311001
			<b>653</b>	M653AU514103001
<b>Bowl Seal Kits</b>		U-Cup Seal Kit (NBR Seals) Kit contains 10 U-Cup seals. This seal is used for all bowls	<b>651</b>	M651AH507403001
			<b>652</b>	M652AH507085001
			<b>653</b>	M653AH514106001
		U-Cup Seal Kit (FKM Seals) Kit contains 10 U-Cup seals. This seal is used for all bowls	<b>651</b>	M651AH507403002
			<b>652</b>	M652AH507085002
			<b>653</b>	M653AH514106002
<b>Side Cover Kits</b>		Blank Side cover Kit with no product identification.	<b>651</b>	M651AY524218001
			<b>652</b>	M652AY524218002
			<b>653</b>	M653AY524218003



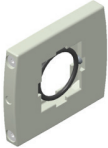
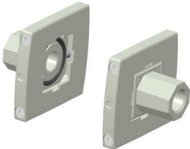
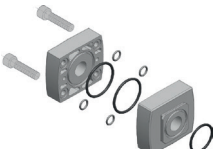
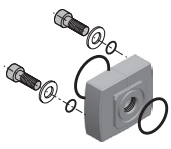
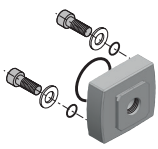

Repair Kits and Service Parts - Spare Parts Kits

	Description	Series	Kit Number	Color	
Filter Elements		651	M651AE434063001	White	
		652	M652AE433582001		
		653	M653AE439490001		
		25 Micron Particulate Filter Element	651	M651AE434063002	Yellow
			652	M652AE433582002	
			653	M653AE439490002	
		40 Micron Particulate Filter Element	651	M651AE434063003	Green
			652	M652AE433582003	
			653	M653AE439490003	
		0.3 Micron Coalescing Filter Element	651	M651AE525276001	Green
			652	EKF22D	
		0.3 Micron Coalescing Filter Element (High Flow)	653	EKF32D	
			653	M653AE516209001	
		0.01 Micron Coalescing Filter Element	651	M651AE525276003	Red
			652	EKF22E	
		0.01 Micron Coalescing Filter Element (High Flow)	653	EKF32E	
			653	M653AE516209003	
		0.3 Micron Coalescing Filter Element - with 3 Micron pre-filter	651	M651AE525276002	Green
			652	EKF22DD	
		0.3 Micron Coalescing Filter Element - with 3 Micron pre-filter (High Flow)	653	EKF32DD	
653			M653AE516209002		
	0.01 Micron Coalescing Filter Element - with 3 Micron pre-filter	651	M651AE525276004	Red	
		652	EKF22ED		
	0.01 Micron Coalescing Filter Element - with 3 Micron pre-filter (High Flow)	653	EKF32ED		
		653	M653AE516209004		
	Adsorber (Activated Carbon) Filter	651	EKF12F	White/ Clear	
		652	EKF22F		
		653	EKF32F		
	Adsorber (Activated Carbon) Filter (High Flow)	653	M653AE516209005		

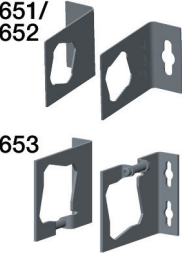

**Repair Kits and Service Parts - Air Prep Assembly and Mounting Kits**

	Description	Series	Kit Number		
	Body-to-Body Assembly Clamps (Includes NBR O-Ring). Clamp material is aluminum.	<b>651</b>	P651AT504958001		
		<b>652</b>	P652AT502466001		
		<b>653</b>	P653AT507291001		
	Body-to-Body Assembly Clamps (Include FKM O-Ring). Clamp material is aluminum.	<b>651</b>	P651AT504958003		
		<b>652</b>	P652AT502466003		
		<b>653</b>	P653AT507291003		
	End Plate Kit: Includes two end plates and Body-to-Body assembly clamps & O-Ring. End Plate material is aluminum.	NBR O-Ring	1/4 NPTF	<b>651</b>	T651AT504959001
			1/2 NPTF	<b>652</b>	T652AT502468001
			1 NPTF	<b>653</b>	T653AT507292001
			1-1/4 NPTF	<b>653</b>	T653AT507292019
			1/4 ISO228/1-G	<b>651</b>	T651AT504959002
			1/2 ISO228/1-G	<b>652</b>	T652AT502468002
			1 ISO228/1-G	<b>653</b>	T653AT507292002
			1-1/4 ISO228/1-G	<b>653</b>	T653AT507292020
			1/4 ISO 7/1 Rc	<b>651</b>	T651AT504959003
			1/2 ISO 7/1 Rc	<b>652</b>	T652AT502468003
		1 ISO 7/1 Rc	<b>653</b>	T653AT507292003	
		1-1/4 ISO 7/1 Rc	<b>653</b>	T653AT507292021	
		FKM O-Ring	1/4 NPTF	<b>651</b>	T651AT504959007
			1/2 NPTF	<b>652</b>	T652AT502468007
			1 NPTF	<b>653</b>	T653AT507292007
			1-1/4 NPTF	<b>653</b>	T653AT507292025
			1/4 ISO228/1-G	<b>651</b>	T651AT504959008
			1/2 ISO228/1-G	<b>652</b>	T652AT502468008
			1 ISO228/1-G	<b>653</b>	T653AT507292008
			1-1/4 ISO228/1-G	<b>653</b>	T653AT507292026
1/4 ISO 7/1 Rc	<b>651</b>		T651AT504959009		
1/2 ISO 7/1 Rc	<b>652</b>		T652AT502468009		
1 ISO 7/1 Rc	<b>653</b>	T653AT507292009			
1-1/4 ISO 7/1 Rc	<b>653</b>	T653AT507292027			
	Panel Adapter P1 + P2 to mount 651 or 652 product on both side of the panel. Certified NEMA 1,4; IP66.	FKM O-Ring	not threaded	<b>651</b>	T651AT522204001
				<b>652</b>	T652AT519954001
	P2 Panel Adapter to connect P1 inlet to 651 or 652 product. Certified NEMA 1,4; IP66.	FKM O-Ring	1/4 NPTF	<b>651</b>	T651AT522204002
			1/2 NPTF	<b>652</b>	T652AT519954002
			1/4 ISO228/1-G	<b>651</b>	T651AT522204003
			1/2 ISO228/1-G	<b>652</b>	T652AT519954003
	P1 Panel Adapter to connect P2 outlet to 651 or 652 product. Certified NEMA 1,4; IP66.	FKM O-Ring	1/4 NPTF	<b>651</b>	T651AT522204004
			1/2 NPTF	<b>652</b>	T652AT519954004
			1/4 ISO228/1-G	<b>651</b>	T651AT522204005
			1/2 ISO228/1-G	<b>652</b>	T652AT519954005

Repair Kits and Service Parts - Air Prep Assembly and Mounting Kits

	Description	Series	Kit Number
	Wall/Panel Bracket Kit includes one bracket and two screws for attaching bracket to body clamp. Two brackets are required for mounting three or more products. One bracket is suitable for mounting two products. Material is aluminum.	<b>651</b> <b>652</b> <b>653</b>	P699AT502467001
	Side Mounting Brackets (Includes two brackets): Designed for mounting single products to wall or panel, but is capable of handling up to 3 stations. Material is stainless steel.	<b>651</b>  <b>652</b>  <b>653</b>	P651AT503860001  P652AT503860002  P653AT503860003
	Panel Nut: Used for Regulators and Filter-Regulators where adjustment knob is fed through a panel and the panel nut is then used to secure the product to the panel. Material is polyamide.	<b>651</b>  <b>652</b>	P651AT513928001  P652AT513177001
	Panel Nut & Bracket: The panel nut and bracket are used to mount a Regulator or Filter-Regulator to a wall or panel. Materials are stainless steel and polyamide.	<b>651</b>  <b>652</b>	P651AT503861001  P652AT503861002
	Series Transition Kit: Includes two body clamps, transition plate and o-rings.	NBR O-Ring    FKM O-Ring	<b>651 to 652</b> T651AT519193001 <b>652 to 653</b> T652AT519194001 <b>651 to 652</b> T651AT519193002 <b>652 to 653</b> T652AT519194002
	Series Transition Kit: Includes two body clamps, transition plate and o-rings.	NBR O-Ring    FKM O-Ring	<b>652 to 651</b> T652AT519193003 <b>653 to 652</b> T653AT519194003 <b>652 to 651</b> T652AT519193004 <b>653 to 652</b> T653AT519194004

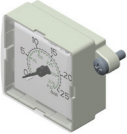
**Repair Kits and Service Parts - Spare Parts Kits**

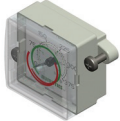
		<b>Description</b>	<b>Series</b>	<b>Kit Number</b>
<b>No Gauge</b>		No Gauge Cover Kit - NBR Seal. Includes gauge cover, screw and O-Ring	<b>651/652/653</b>	M699AG503396001
		No Gauge Cover Kit - FKM Seal. Includes gauge cover, screw and O-Ring	<b>651/652/653</b>	M699AG503396002
<b>Low Profile Gauges*</b>		Low Profile Gauge - 651/652/653 Series: 0–90 PSI Scale with NBR seals	<b>651/652/653</b>	M699AG438047005
		Low Profile Gauge - 651/652/653 Series: 0–90 PSI Scale with FKM seals	<b>651/652/653</b>	M699AG438047017
		Low Profile Gauge - 651/652/653 Series: 0–175 PSI Scale with NBR seals	<b>651/652/653</b>	M699AG438047004
		Low Profile Gauge - 651/652/653 Series: 0–175 PSI Scale with FKM seals	<b>651/652/653</b>	M699AG438047016
		Low Profile Gauge - 651/652/653 Series: 0–375 PSI Scale with NBR seals	<b>651/652/653</b>	M699AG438047006
		Low Profile Gauge - 651/652/653 Series: 0–375 PSI Scale with FKM seals	<b>651/652/653</b>	M699AG438047018
		Low Profile Gauge - 651/652/653 Series: 0–6 bar Scale with NBR seals	<b>651/652/653</b>	M699AG438047002
		Low Profile Gauge - 651/652/653 Series: 0–6 bar Scale with FKM seals	<b>651/652/653</b>	M699AG438047014
		Low Profile Gauge - 651/652/653 Series: 0–12 bar Scale with NBR seals	<b>651/652/653</b>	M699AG438047001
		Low Profile Gauge - 651/652/653 Series: 0–12 bar Scale with FKM seals	<b>651/652/653</b>	M699AG438047013
		Low Profile Gauge - 653 Series and SOV for 651/652/653: 0–25 bar Scale with NBR seals	<b>651/652/653</b>	M699AG438047003
		Low Profile Gauge - 653 Series and SOV for 651/652/653: 0–25 bar Scale with FKM seals	<b>651/652/653</b>	M699AG438047015
		Pressure Range Indicators (Red/Green) for Low Profile Gauges. Desired range can be easily set in the field. This kit allows customers to add the pressure range indicator to existing low profile gauges in the field.	<b>651/652/653</b>	M699AG500179001
		Low Profile Gauge with Pressure Range Indicator - 651/652/653 Series: 0–90 PSI Scale with NBR seals	<b>651/652/653</b>	M699AG438047011
		Low Profile Gauge with Pressure Range Indicator - 651/652/653 Series: 0–175 PSI Scale with NBR seals	<b>651/652/653</b>	M699AG438047010
Low Profile Gauge with Pressure Range Indicator - 651/652/653 Series: 0–375 PSI Scale with NBR seals		<b>651/652/653</b>	M699AG438047012	
Low Profile Gauge with Pressure Range Indicator - 651/652/653 Series: 0–6 bar Scale with NBR seals		<b>651/652/653</b>	M699AG438047008	
Low Profile Gauge with Pressure Range Indicator - 651/652/653 Series: 0–12 bar Scale with NBR seals		<b>651/652/653</b>	M699AG438047007	
Low Profile Gauge with Pressure Range Indicator - 653 Series and SOV for 651/652/653: 0–25 bar Scale with NBR seals		<b>651/652/653</b>	M699AG438047009	

\* Each of the Low Profile and Round Gauges are dual scale; consult factory for further information. The scale that is listed in the description has the units located near the outside of the scale. The other units would be on the inside.









Repair Kits and Service Parts - Spare Parts Kits







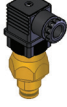

		Description	Series	Kit Number
<b>Digital Gauge</b>		Digital Pressure Gauge - 651/652/653 Series: 0–145 PSI Scale (User can change units; bar, MPa, Kgf/cm²) 1/8" NPTF	<b>651/652/653</b>	M699AG504650001
		Digital Pressure Gauge - 651/652/653 Series: 0–145 PSI Scale (User can change units; bar, MPa, Kgf/cm²) 1/8" ISO 7/1 Rc	<b>651/652/653</b>	M699AG504650002
<b>Round Gauges*</b>		Round Gauge - 0–60 PSI Series 1/8 NPTF and 1.5" Face Diameter	<b>651/652/653</b>	214-116
		Round Gauge - 0–160 PSI Series 1/8 NPTF and 1.5" Face Diameter	<b>651/652/653</b>	214-103
		Round Gauge - 0–300 PSI 1/8 NPTF and 1.5" Face Diameter	<b>651/652/653</b>	214-118
		Round Gauge - 0–60 PSI 1/8 ISO 7/1 Rc and 1.5" Face Diameter	<b>651/652/653</b>	RA060
		Round Gauge - 0–160 PSI 1/8 ISO 7/1 Rc and 1.5" Face Diameter	<b>651/652/653</b>	214-153
		Round Gauge - 0–300 PSI 1/8 ISO 7/1 Rc and 1.5" Face Diameter	<b>651/652/653</b>	RA300A
		Round Gauge - 0–4 bar 1/8 ISO 7/1 Rc and 40mm Face Diameter (Europe)	<b>651/652/653</b>	34300015
		Round Gauge - 0–10 bar 1/8 ISO 7/1 Rc and 40mm Face Diameter (Europe)	<b>651/652/653</b>	34300014
		Round Gauge - 0–12 bar 1/8 ISO 7/1 Rc and 40mm Face Diameter (Europe)	<b>651/652/653</b>	34300041
		Round Gauge - 0–25 bar 1/8 ISO 7/1 Rc and 50mm Face Diameter (Europe)	<b>651/652/653</b>	34200063
		Round Gauge - 0–4 bar 1/8 ISO 7/1 Rc and 50mm Face Diameter (Europe)	<b>651/652/653</b>	34200061
		Round Gauge - 0–12 bar 1/8 ISO 7/1 Rc and 50mm Face Diameter (Europe)	<b>651/652/653</b>	34200062
		Round Gauge - 0–16 bar 1/8 ISO 7/1 Rc and 50mm Face Diameter (Europe)	<b>651/652/653</b>	34200997
		Stainless Steel Round Gauge - 0–12 bar 1/8 ISO 7/1 Rc and 50 mm Face Diameter	<b>651/652/653</b>	34303242
<b>Port Plates</b>		Gauge Port Plate Assembly - 1/8 NPTF	<b>651/652/653</b>	M699AG440510001
		Gauge Port Plate Assembly - 1/8 ISO 7/1 Rc	<b>651/652/653</b>	M699AG440510002
<b>Pressure Switch/Sensor</b>		DPS280 Pressure Switch/Sensor - NPN M8 with Cable 1/8 ISO 7/1 Rc	<b>651/652/653</b>	DPS280NRQ8
		DPS280 Pressure Switch/Sensor - PNP M8 with Cable 1/8 ISO 7/1 Rc	<b>651/652/653</b>	DPS280PRQ8
		DPS280 Pressure Switch/Sensor - NPN M8 with Cable 1/8 NPTF	<b>651/652/653</b>	DPS280NNQ8
		DPS280 Pressure Switch/Sensor - PNP M8 with Cable 1/8 NPTF	<b>651/652/653</b>	DPS280PNQ8
		Pressure Switch: 1/8 NPTF, 20–130 PSI (1.4 to 9 bar) range, Brass/NBR 3 PIN M12 connection (12mm); IP65	<b>651/652/653</b>	PS182CAN01-2
		Pressure Switch: 1/8 NPTF, 20–130 PSI (1.4 to 9 bar) range, Brass/NBR 3 PIN M12 connection (12mm); IP65	<b>651/652/653</b>	PS182CAN01
		Pressure Switch: 1/8 BSPP, 20–130 PSI (1.4 to 9 bar) range, Brass/NBR 3 PIN M12 connection (12mm); IP65	<b>651/652/653</b>	PS182CAG01
		Pressure Switch: 1/8 NPTF, 14–150 PSI (1 to 10 bar) range, Zinc Plated Steel/ NBR Polyamide Connector Material, 4 PIN DIN Connector; IP65	<b>651/652/653</b>	PS180CAN01
-	Connector/Cord-set for PS182 - 90° Elbow: 5 Meter cable	<b>651/652/653</b>	PS182-5-90	
-	Connector/Cord-set for PS182 - Straight: 5 Meter cable	<b>651/652/653</b>	PS182-5-ST	

\* Each of the Low Profile and Round Gauges are dual scale; consult factory for further information. The scale that is listed in the description has the units located near the outside of the scale. The other units would be on the inside.

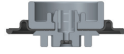

Note: For all pressure switches & round gauges that are added to series products in the field, a port plate is required. The port plate can be added at the time of order entry or as a kit.

Repair Kits and Service Parts - Spare Parts Kits				
		Description	Series	Kit Number
<b>Lubricator Repair Kits</b>		Lubricator Dome Repair Kit - NBR seals. Includes dome cover, screw and O-Rings.	<b>651</b> <b>652</b> <b>653</b>	M699AY506842001
		Lubricator Dome Repair Kit - FKM seals. Includes dome cover, screw and O-Rings.	<b>651</b> <b>652</b> <b>653</b>	M699AY506842002
		Lubricator Level Switch assembly kit. Includes level switch, stainless steel retainer ring, O-Ring and bushing.	<b>651</b> <b>652</b> <b>653</b>	M699AG506837001
		Lubricator Bowl Plug assembly: Includes Lubricator bowl plug, stainless steel retainer ring and NBR O-Ring.	<b>651</b> <b>652</b> <b>653</b>	M699AQ440512001
<b>Filter Kits</b>		Particulate Filter Repair Kit - includes the filter retainer, head baffle, lower end cap and bowl baffle.	<b>651</b>	M651AY570170001
			<b>652</b>	M652AY506833001
			<b>653</b>	M653AY514105001
		Differential Pressure Pop-up Indicator (NBR Seals) This is used for the Coalescing Filters to provide visual indication when the filter element needs to be replaced.	<b>651</b> <b>652</b> <b>653</b>	M699AG439851001
			<b>651</b> <b>652</b> <b>653</b>	M699AG439851004
		DPI Plug (NBR Seals) This is used to plug the top port on the filter when a Differential Pressure Indicator is not used.	<b>651</b> <b>652</b> <b>653</b>	M699AG439851002
			<b>651</b> <b>652</b> <b>653</b>	M699AG439851005
	Electric Differential Pressure Indicator (NBR Seals) This is used for the Coalescing Filter only. It provides a contact that will actuate when the filter element needs to be replaced.	<b>651</b> <b>652</b> <b>653</b>	M699AG439851003	

Repair Kits and Service Parts - Spare Parts Kits

		Description	Series	Kit Number
Regulator & Filter Regulator Kits		Adjusting Screw Repair Kit - includes adjusting screw, nut, washer and screw	651	M651AY514012001
			652	M652AY506952001
			653	M653AY514104001
		Key Lockable Adjusting Screw Repair Kit - includes adjusting screw, adjusting nut, flat washer and screw	651	M651AY514012002
			652	M652AY506952002
			653	M653AY514104002
		Tamper Resistant Repair Kit - includes adjusting screw, adjusting nut, flat washers and screws	651	M651AY514012003
			652	M652AY506952003
			653	M653AY514104003
		Replacement Knob for Regulator or Filter/Regulators	651	M651AY519042001
			652	M652AY519042003
			653	M653AY519042005
		Replacement Knob for the tamper resistant or key lockable Regulator or Filter/Regulators	651	M651AY519042002
			652	M652AY519042004
			653	M653AY519042006
		Poppet Repair Kit (NBR Seals): Includes poppet, stem & seals	651	M651AY507175001
			652	M652AY506863001
			653	M653AY507270001
		Poppet Repair Kit (FKM Seals): Includes poppet, stem & seals	651	M651AY507175002
			652	M652AY506863002
			653	M653AY507270002
		Diaphragm Assembly Repair Kit (Pilot Operated Regulator NBR Seals)	652	M652AH435268001
		Diaphragm Assembly Repair Kit (Pilot Operated Regulator FKM Seals)	652	M652AH435268002
		Diaphragm Assembly Repair Kit (Relieving Regulator NBR Seals)	651	M651AH504954001
			652	M652AH434213001
			653	M653AH502120001
		Diaphragm Assembly Repair Kit (Relieving Regulator FKM Seals)	651	M651AH504954002
			652	M652AH434213002
			653	M653AH502120002
		Diaphragm Assembly Repair Kit (Non-relieving Regulator NBR Seals)	651	M651AH504954003
652			M652AH434213003	
653			M653AH502120003	
Diaphragm Assembly Repair Kit (Non-relieving Regulator - FKM Seals)		651	M651AH504954004	
		652	M652AH434213004	
		653	M653AH502120004	
	Main Spring (45 PSIG/3 bar)	651	M651AY514010001	
		652	M652AY513313001	
		653	M653AY516711001	
	Main Spring (60 PSI/4 bar)	651	M651AY504691001	
		652	M652AY438708001	
		653	M653AY516710001	
	Main Spring (125 PSI/8 bar)	651	M651AY504692001	
		652	M652AY438709001	
		653	M653AY516709001	
	Main Spring (145 PSI/10 bar)	651	M651AY514011001	
		652	M652AY513314001	
		653	M653AY516708001	

**Repair Kits and Service Parts - Spare Parts Kits**

		<b>Description</b>	<b>Series</b>	<b>Part/Kit Number</b>
<b>3/2 Slow Start/ Quick Exhaust Valve Kits</b>		Horizontal Solenoid Operator (190) - with Manual Override	<b>651</b> <b>652</b>	19090017
		Horizontal Solenoid Operator (190) - without Manual Override	<b>651</b> <b>652</b>	19090005
		24 VDC coil with 3 Pin M12 Connection, for Horizontal Solenoid Operator	<b>651</b> <b>652</b>	43005525
		24 VDC coil with DIN Spade connection for Horizontal Solenoid Operator	<b>651</b> <b>652</b>	43004473
		120 VAC coil with DIN Spade connection for Horizontal Solenoid Operator	<b>651</b> <b>652</b>	43004471
		24 VAC coil with DIN Spade connection for Horizontal Solenoid Operator	<b>651</b> <b>652</b>	43004469
		240 VAC coil with DIN Spade connection for Horizontal Solenoid Operator	<b>651</b> <b>652</b>	43004472
		DIN Connector, without LED - Horizontal Solenoid Operator	<b>651</b> <b>652</b>	88122602
		DIN Connector, with LED, for 24 VAC/DC coil - Horizontal Solenoid Operator	<b>651</b> <b>652</b>	88122603
		DIN Connector, with LED, for 120 VAC coil - Horizontal Solenoid Operator	<b>651</b> <b>652</b>	88122605
	DIN Connector, with LED, for 240 VAC coil - Horizontal Solenoid Operator	<b>651</b> <b>652</b>	88122608	
		Vertical Solenoid Operator (189) - without Manual Override	<b>651</b> <b>652</b>	18990007
		24 VDC coil with 3 Pin M12 Connection, for Vertical Solenoid Operator	<b>651</b> <b>652</b>	43005523
		24 VDC coil with DIN Spade connection for Vertical Solenoid Operator	<b>651</b> <b>652</b>	43004166
		120 VAC coil with DIN Spade connection for Vertical Solenoid Operator	<b>651</b> <b>652</b>	43004419
		24 VAC coil with DIN Spade connection for Vertical Solenoid Operator	<b>651</b> <b>652</b>	43004416
		240 VAC coil with DIN Spade connection for Vertical Solenoid Operator	<b>651</b> <b>652</b>	43004422
		DIN Connector, without LED - Vertical Solenoid Operator	<b>651</b> <b>652</b>	88122404
		DIN Connector, with LED, for 24 VAC/DC coil - Vertical Solenoid Operator	<b>651</b> <b>652</b>	88122405
		DIN Connector, with LED, for 120 VAC coil - Vertical Solenoid Operator	<b>651</b> <b>652</b>	88122407
DIN Connector, with LED, for 240 VAC coil - Vertical Solenoid Operator		<b>651</b> <b>652</b>	88122410	

Repair Kits and Service Parts - Spare Parts Kits

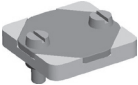
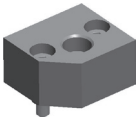
		Description	Series	Part/Kit Number
<b>3/2 Slow Start/ Quick Exhaust Valve Kits</b>		Horizontal Solenoid Operator (192) - with Manual Override	<b>653</b>	19291012
		Horizontal Solenoid Operator (192) - without Manual Override	<b>653</b>	19291010
		24 VDC coil with 3 Pin M12 Connection, for Horizontal Solenoid Operator	<b>653</b>	43005664
		24 VDC coil with DIN Spade connection for Horizontal Solenoid Operator	<b>653</b>	43005642
		120 VAC coil with DIN Spade connection for Horizontal Solenoid Operator	<b>653</b>	43005617
		24 VAC coil with DIN Spade connection for Horizontal Solenoid Operator	<b>653</b>	43005604
		240 VAC coil with DIN Spade connection for Horizontal Solenoid Operator	<b>653</b>	43005627
		DIN Connector, without LED - Horizontal Solenoid Operator	<b>653</b>	88122602
		DIN Connector, with LED, for 24 VAC/DC coil - Horizontal Solenoid Operator	<b>653</b>	88122603
		DIN Connector, with LED, for 120 VAC coil - Horizontal Solenoid Operator	<b>653</b>	88122605
		DIN Connector, with LED, for 240 VAC coil - Horizontal Solenoid Operator	<b>653</b>	88122608
<b>Jumper Plate Kit</b>		Jumper Plate Kit: For Air Operated Internally Piloted 3/2 Slow Start/Quick Exhaust Valve	<b>651 652 653</b>	M699AY513316001
<b>Pilot Port Plate</b>		Pilot Port Plate: For Air Operated Externally Piloted 3/2 Slow Start/Quick Exhaust Valve	<b>651 652 653</b>	M699AY513318001
		Pilot Port Plate: For Air Operated Externally Piloted 3/2 Slow Start/Quick Exhaust Valve, 1/8 NPT	<b>651 652 653</b>	M699AY513318002

**Accessories**

		<b>Description</b>	<b>Series</b>	<b>Kit Number</b>
<b>Scissor Lock</b>		Scissor Lock for Shut Off Isolation Valve & Lockout Valve	<b>651</b> <b>652</b> <b>653</b>	VB-1
<b>Mufflers/ Silencers</b>		Metal Muffler - 1/4 NPTF (Shut Off Isolation Valves & Slow Start/Quick Exhaust Valves)	<b>651</b> <b>652</b>	M2MN
		Metal Muffler - 3/8 NPTF (Shut Off Isolation Valves & Slow Start/Quick Exhaust Valves)	<b>653</b>	M3MN
		Metal Muffler - 1/2 NPTF (Slow Start/Quick Exhaust & Lockouts)	<b>651</b> <b>652</b>	M4MN
		Metal Muffler - 1 NPTF (Slow Start/Quick Exhaust & Lockouts)	<b>653</b>	M6MN
		Polyethylene Muffler - 1/4 NPTF (Shut Off Isolation Valves & Slow Start/Quick Exhaust)	<b>651</b> <b>652</b>	E2MN
		Polyethylene Muffler - 3/8 NPTF (Shut Off Isolation Valves)	<b>653</b>	E3MN
Polyethylene Muffler - 1/2 NPTF (Slow Start/Quick Exhaust & Lockouts)		<b>651</b> <b>652</b>	E4MN	
<b>Key Lock</b>		Key lock for Regulator and Filter-Regulator supplied seperately with 2 keys	<b>651</b> <b>652</b> <b>653</b>	M699AY438663001





## Global Contacts

Australia	(61) 2-9-451-7077	France	(33) 2-37-24-42-24	Netherlands	(31) 33-277-7911
Brazil	(55) 11-4208-1700	Germany	(49) 7237-9960	Singapore	(65) 6556-1100
Canada	(1) 519-758-2700	India	(91) 44-39197300	South Korea	(82) 2-3483-1570
China	(86) 21-3395-0000	Italy	(39) 02-356931	Spain	(34) 942-87-6100
Czech Republic	(420) 235-090-061	Japan	(81) 798-65-6361	United Kingdom	(44) 1695-713600
Dubai - UAE	(971) 4-811-8200	Mexico	(52) 55-5809-5640		