



MELCHER
The Power Partners.

a bel power solutions brand

PSB Series Positive Switching Regulator

The PSB Series of positive switching regulators are designed as power supplies for electronic systems, where no input-to-output isolation is required. Their major advantages include a high level of efficiency, high reliability, low output ripple, and excellent dynamic response. Models with input voltages up to 144V are specially designed for secondary switched and battery-driven mobile applications. The converters are suitable for railway applications according to EN 50155 and EN 50121.

The case design allows for operation up to 71 °C. The PSB Series is designed for wall or chassis mounting with faston connectors.

Various options are available to adapt the converters to different applications.

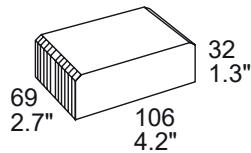

Features

- RoHS lead-free-solder and lead-solder-exempted products are available
- 5 year warranty for RoHS compliant products with an extended temperature range
- Input voltage up to 144 VDC
- Single output of 5.1 to 48 VDC
- No input-to-output isolation
- High efficiency up to 96%
- Extremely wide input voltage range
- Low input-to-output differential voltage
- Very good dynamic properties
- Input undervoltage lockout
- Output voltage adjustment and inhibit function
- Continuously no-load and short-circuit proof
- All boards are coated with a protective lacquer

Safety-approved to the latest edition of IEC/EN 60950-1 and UL/CSA 60950-1



Table of Contents

Description.....	1
Model Selection.....	2
Functional Description.....	3
Electrical Input Data.....	4
Electrical Output Data.....	6
Auxiliary Functions.....	10

Electromagnetic Compatibility (EMC).....	11
Immunity to Environmental Conditions.....	12
Mechanical Data.....	13
Safety and Installation Instructions.....	14
Description of Options.....	15
Accessories.....	16

Model Selection

Table 1: Model Selection

Output voltage $V_{o\ nom}$ [V]	Output current $I_{o\ nom}$ [A]	Operating input voltage range V_i [V]	Nom. input voltage $V_{i\ nom}$ [V]	Efficiency ²		Type designation	Options
				η_{min} [%]	η_{max} [%]		
5.1	4 ³	15 - 144 ¹	60	76	80	PSB5A4-9iRG	L, C
5.1	6	8 - 80	40	79	82.5	PSB5A6-9iRG	-7, L, C, non-G
5.1	7	7 - 40	20	83	84.5	PSB5A7-9iRG	-7, L, P, C, non-G
5.1	8	7 - 40	20	82.5	84	PSB5A8-2iRG	non-G
12	3 ⁴	18 - 144 ¹	60	87	88.5	PSB123-9iRG	-7, L, C, non-G
12	5	15 - 80	40	89	90.5	PSB125-9iRG	-7, L, C, non-G
12	6	15 - 40	20	89.5	91	PSB126-2iRG	---
15	3 ⁴	22 - 144 ¹	60	89	90	PSB153-9iRG	-7, L, C, non-G
15	5	19 - 80	40	90.5	92.5	PSB155-9iRG	-7, L, C, non-G
15	6	19 - 40	30	91	92.5	PSB156-2iRG	---
24	3 ⁴	31 - 144 ¹	60	92.5	94	PSB243-9iRG	-7, L, C, non-G
24	5	29 - 80	50	93.5	95	PSB245-9iRG	-7, L, C, non-G
24	6	29 - 60	40	94	96	PSB246-2iRG	non-G
36	3 ⁴	44 - 144 ¹	80	94	95	PSB363-9iRG	-7, L, C, non-G
36	5	42 - 80	60	95.5	96.5	PSB365-9iRG	-7, L, C, non-G
48	3 ⁴	58 - 144 ¹	80	95.5	96.5	PSB483-9iRG	-7, L, C, non-G

¹ Surges up to 156 V for 2 s; see *Electrical Input Data*

² Efficiency at $V_{i\ nom}$ and $I_{o\ nom}$

³ $I_{o\ max} = 5\ A$ at $V_i \leq 80\ V$; for $V_i > 80\ V$, see fig. 4.

⁴ $I_{o\ max} = 4\ A$ at $V_i \leq 80\ V$; for $V_i > 80\ V$, see fig. 4.

NFND: Not for new designs. Preferred for new designs.

Note: The sequence of options must follow the order above.

Part Number Description

PSB 12 3 -9 L i R C G

- Positive switching regulator in case B02 PSB
- Nominal output voltage in volt 5.1 to 48
- Nominal output current in Ampère 3 to 8
- Operational ambient temperature range T_A
 - 10 to 50 °C -2
 - 25 to 50 °C -5
 - 25 to 71 °C (option) -7
 - 40 to 71 °C -9
 - other (customer-specific models) 0
- Input filter (option) L
- Inhibit input (standard) i
- Control input for output voltage adjustment¹ R
- Potentiometer¹ (option) P
- Thyristor crowbar (option) C
- RoHS-compliant for all 6 substances G

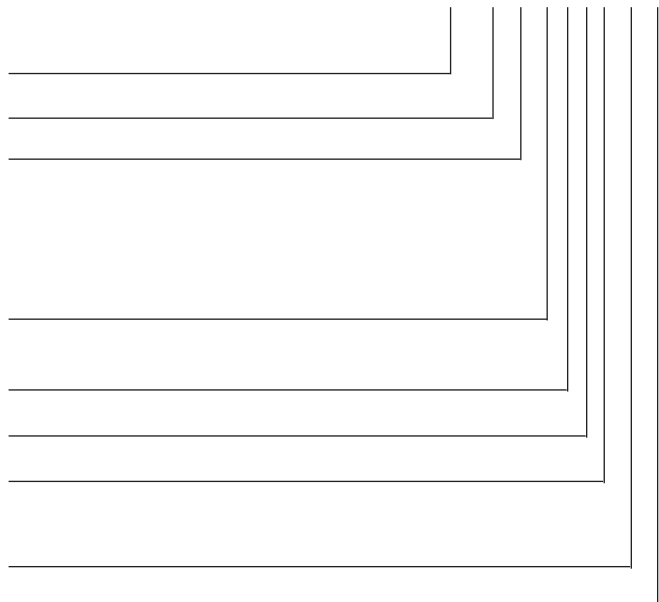

¹ Feature R excludes option P and vice versa.

Note: The sequence of options must follow the order above.

Example: PSB123-9LiRCG designates a positive switching regulator with output 12 V, 3 A, ambient temperature range of -40 to 71 °C, input filter, inhibit input, output adjust input, thyristor crowbar, and RoHS-compliant.

Customer-Specific Models

Positive switching regulator in case B01	PSB
Nominal output voltage in Volt (without decimals).....	12
Decimal places:	
0.0 V.....	Z
0.1 V.....	A
0.15 V.....	B
0.2 V.....	C
0.25 V.....	D
0.3 V.....	E
0.4 V.....	F
0.5 V.....	G
0.6 V.....	H
0.7 V.....	J
0.8 V.....	K
0.9 V.....	L
other.....	Y
Output current in Amperes	3
Identification character	A, B, ...
Temperature range and options	-9iRG

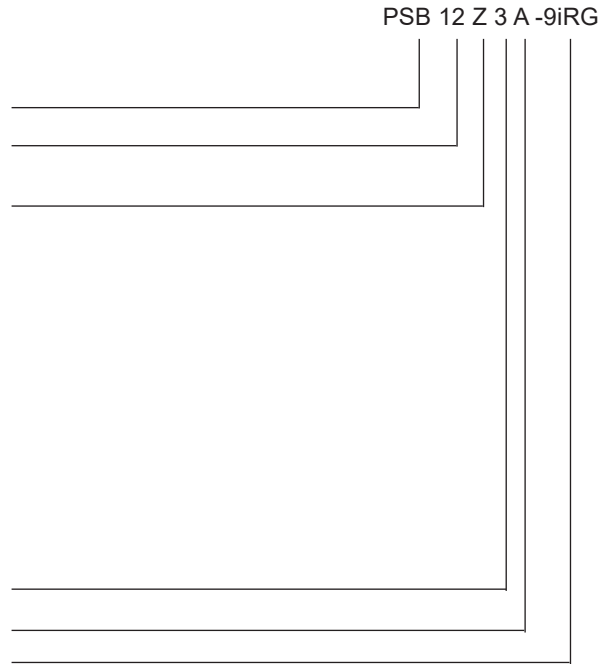

Product Marking

Type designation, applicable safety approval marks, warnings, pin allocation, patent nos., and company logo.

Input voltage range, nominal output voltage and current, pin allocation of auxiliary functions and options, and protection degree. Identification of LED and the optional potentiometer.

Label with input voltage range, nominal output voltage and current, protection degree, batch no., serial no., and data code including production site, version (modification status), date of production.

Functional Description

This switching regulator uses the buck converter topology. The input is not electrically isolated from the output. During the on period of the switching transistor, current is transferred to the output, and energy is stored in the output choke. During the off period, this energy forces the current to keep flowing through the output, to the load, and back through the freewheeling diode. Regulation is accomplished by varying the duty cycle (on/ratio) of the power switch. The regulator is equipped with a undervoltage lockout, but no overvoltage shutdown.

These regulators are ideal for a wide range of applications, where input to output isolation is not necessary, or where already provided by an external front end (e.g., a transformer with rectifier). To optimize customer's needs, additional options and accessories are available.

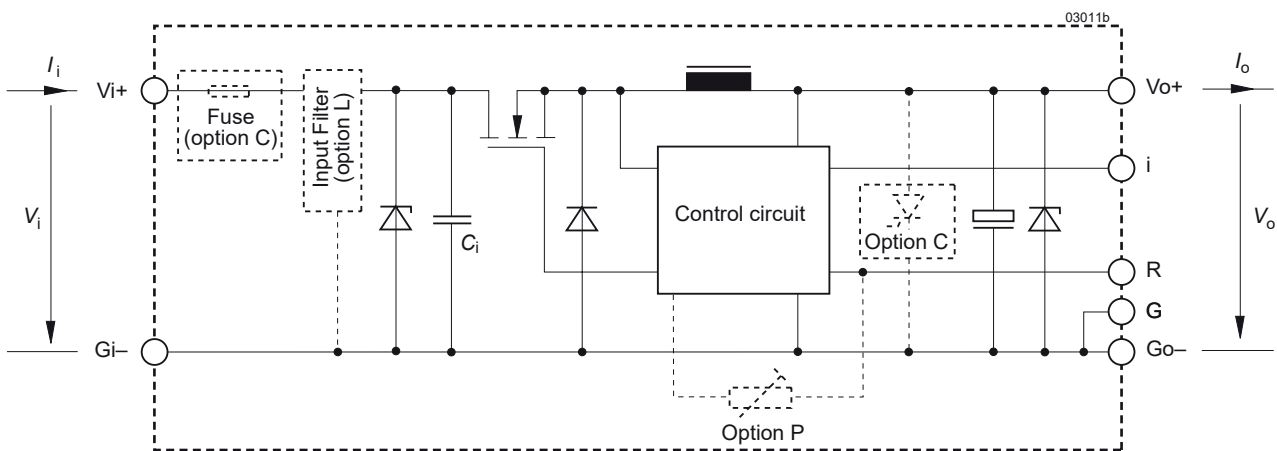

Fig. 1
Block diagram PSB

Electrical Input Data

General Conditions: $T_A = 25\text{ }^\circ\text{C}$, unless T_C is specified

Table 2a: Input data (-2 models)

Model			PSB5A8			PSB126			PSB156			PSB246			Unit	
Characteristics		Conditions	min	typ	max	min	typ	max	min	typ	max	min	typ	max		
V_i	Operating input voltage	$I_o = 0 - I_{o,nom}$ $T_{C,min} - T_{C,max}$	7		40	15		40	19		40	29		60	V	
$\Delta V_{io,min}$	Min. diff. voltage $V_i - V_o$				1.9			3				4				5
$V_{i,UVL}$	Undervoltage lockout				7.3			7.3				7.3				12
I_{i0}	No-load input current	$I_o = 0, V_{i,min} - V_{i,max}$			50			50			50			50	mA	
$I_{in,p}$	Inrush peak current	$V_{i,nom}$		75			75			150			150		A	
R_i	Input resistance	no option L		10			10			10			10		mΩ	
C_i	Input capacitance				13.6			13.6			13.6			13.6		μF
$V_{i,RFI}$	EN 55011, 0.15 - 30 MHz	$V_{i,nom}, I_{o,nom}$		A			A			A			A		Class	

Table 2b: Input data

Model			PSB5A7			PSB5A6			PSB125			Unit
Characteristics		Conditions	min	typ	max	min	typ	max	min	typ	max	
V_i	Operating input voltage	$I_o = 0 - I_{o,nom}$ $T_{C,min} - T_{C,max}$	7		40	8		80	15		80	V
$\Delta V_{io,min}$	Min. diff. voltage $V_i - V_o$				1.9			2.9			3	
$V_{i,UVL}$	Undervoltage lockout				6.3			7.3			7.3	
I_{i0}	No-load input current	$I_o = 0, V_{i,min} - V_{i,max}$			45			40			35	mA
$I_{in,p}$	Inrush peak current	$V_{i,nom}$ without option L		75			150			150		A
R_i	Input resistance				10			10			10	mΩ
C_i	Input capacitance	$V_{i,nom}$ with option L		13.6			13.6			13.6		μF
$I_{in,p}$	Inrush peak current				100			180			180	A
R_i	Input resistance				340			340			340	mΩ
C_i	Input capacitance			484			344			344	μF	
$V_{i,RFI}$	EN 55011, 0.15 - 30 MHz	$V_{i,nom}, I_{o,nom}$ with option L		A			A			A		Class

Table 2c: Input data

Model			PSB155			PSB245			PSB365			Unit
Characteristics		Conditions	min	typ	max	min	typ	max	min	typ	max	
V_i	Operating input voltage	$I_o = 0 - I_{o,nom}$ $T_{C,min} - T_{C,max}$	19		80	29		80	42		80	V
$\Delta V_{io,min}$	Min. diff. voltage $V_i - V_o$				4			5			6	
$V_{i,UVL}$	Undervoltage lockout				7.3			12			19	
I_{i0}	No-load input current	$I_o = 0, V_{i,min} - V_{i,max}$			35			35			40	mA
$I_{in,p}$	Inrush peak current	$V_{i,nom}$ without option L		150			150			150		A
R_i	Input resistance				10			10			10	mΩ
C_i	Input capacitance	$V_{i,nom}$ with option L		13.6			13.6			13.6		μF
$I_{in,p}$	Inrush peak current				180			180			180	A
R_i	Input resistance				340			340			340	mΩ
C_i	Input capacitance			344			344			344	μF	
$V_{i,RFI}$	EN 55011, 0.15 - 30 MHz	$V_{i,nom}, I_{o,nom}$ with option L		A			A			A		Class

Table 2d: Input data. General Conditions as per Table 2a

Model		PSB5A4			PSB123			PSB153			Unit
Characteristics	Conditions	min	typ	max	min	typ	max	min	typ	max	
V_i	Operating input voltage	15		144 ¹	18		144 ¹	22		144 ¹	V
$\Delta V_{io \min}$	Min. diff. voltage $V_i - V_o$			9.9			6			7	
$V_{i \text{UVL}}$	Undervoltage lockout		10			12			15		
I_{i0}	No-load input current			40			35			35	mA
$I_{inr p}$	Inrush peak current		150			150			150		A
R_i	Input resistance		10			10			10		mΩ
C_i	Input capacitance		4.4			4.4			4.4		μF
$I_{inr p}$	Inrush peak current		180			180			180		A
R_i	Input resistance		340			340			340		mΩ
C_i	Input capacitance		104			104			104		μF
$V_{i \text{RFI}}$	EN 55011, 0.15 - 30 MHz		A ²			A ²			A ²		Class

Table 2e: Input data

Model		PSB243			PSB363			PSB483			Unit
Characteristics	Conditions	min	typ	max	min	typ	max	min	typ	max	
V_i	Operating input voltage	31		144 ¹	44		144 ¹	58		144 ¹	V
$\Delta V_{io \min}$	Min. diff. voltage $V_i - V_o$			7			8			10	
$V_{i \text{UVL}}$	Undervoltage lockout		19			29			40		
I_{i0}	No-load input current			35			40			45	mA
$I_{inr p}$	Inrush peak current		150			150			150		A
R_i	Input resistance		10			10			10		mΩ
C_i	Input capacitance		4.4			4.4			4.4		μF
$I_{inr p}$	Inrush peak current		180			180			180		A
R_i	Input resistance		340			340			340		mΩ
C_i	Input capacitance		104			104			104		μF
$V_{i \text{RFI}}$	EN 55011, 0.15 - 30 MHz		A ²			A ²			A ²		Class

¹ Surges up to 156 V for 2 s

² With external input capacitor $C_i = 470 \mu\text{F} / 200 \text{V}$ and option L

External Input Circuitry and Fuse

The sum of the lengths of the supply lines to the source or to the nearest capacitor $\geq 100 \mu\text{F}$ (a + b) should not exceed 5 m, unless option L is fitted. This option is recommended in order to prevent power line oscillations and reduce superimposed interference voltages.

Regulators with option C are fitted with an input fuse.

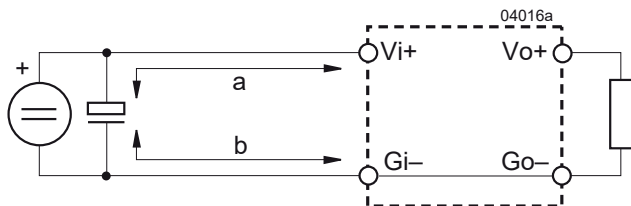

Fig. 2
Switching regulator with long supply lines.

Electrical Output Data

General conditions:

- $T_A = 25\text{ °C}$, unless T_C is specified
- R-input open (or V_o set to $V_{o\text{ nom}}$ with option P)

Table 3a: Output data

Output			PSB5A8			PSB126			PSB156			PSB246			Unit	
Characteristics			Conditions			min	typ	max	min	typ	max	min	typ	max		
V_o	Output voltage		$V_{i\text{ nom}}, I_{o\text{ nom}}$			5.05	5.15		11.6	12.4		14.5	15.5	23.3	24.7	V
I_o	Output current		$V_{i\text{ min}} - V_{i\text{ max}}$			0	8.0		0	6.0		0	6.0	0	6.0	A
I_{oL}	Output current limitation		$T_{C\text{ min}} - T_{C\text{ max}}$			8.0	10.4		6.0	7.8		6.0	7.8	6.0	7.8	
V_o	Output voltage noise	Switching frequency	$V_{i\text{ nom}}, I_{o\text{ nom}}$ IEC/EN 61204				40			150			200		300	mV _{pp}
		Total	BW = 20 MHz				45			160			210		310	
ΔV_{oV}	Static line regulation		$V_{i\text{ min}} - V_{i\text{ max}}, I_{o\text{ nom}}$				100			240			300		480	mV
ΔV_{oI}	Static load regulation		$V_{i\text{ nom}}, I_o = 0 - I_{o\text{ nom}}$				100			180			200		300	
V_{oD}	Dynamic load regulation	Voltage deviation	$V_{i\text{ nom}}$ $I_{o\text{ nom}} \leftrightarrow 1/3 I_{o\text{ nom}}$				150			360			450		700	μs
t_d		Recovery time	IEC/EN 61204				100			120			120		160	
α_{V_o}	Temperature coefficient $\Delta V_o / \Delta T_C (T_{C\text{ min}} - T_{C\text{ max}})$		$V_{i\text{ min}} - V_{i\text{ max}}$ $I_o = 0 - I_{o\text{ nom}}$				± 0.02			± 0.02			± 0.02		± 0.02	%/K

Table 3b: Output data

Output			PSB5A7			PSB5A6			PSB125			Unit			
Characteristics			Conditions			min	typ	max	min	typ	max		min	typ	max
V_o	Output voltage		$V_{i\text{ nom}}, I_{o\text{ nom}}$			5.07		5.13	5.07		5.13	11.93		12.07	V
I_o	Output current		$V_{i\text{ min}} - V_{i\text{ max}}$			0		7.0	0		6.0	0		5.0	A
I_{oL}	Output current limitation		$T_{C\text{ min}} - T_{C\text{ max}}$			7.0		9.1	6.0		7.8	5.0		6.5	
V_o	Output voltage noise	Switching frequency	$V_{i\text{ nom}}, I_{o\text{ nom}}$ IEC/EN 61204				15	25		15	35		25	45	mV _{pp}
		Total	BW = 20 MHz				19	29		19	39		29	49	
ΔV_{oV}	Static line regulation		$V_{i\text{ min}} - V_{i\text{ max}}, I_{o\text{ nom}}$					100			100			240	mV
ΔV_{oI}	Static load regulation		$V_{i\text{ nom}}, I_o = 0 - I_{o\text{ nom}}$					100			100			120	
V_{oD}	Dynamic load regulation	Voltage deviation	$V_{i\text{ nom}}$ $I_{o\text{ nom}} \leftrightarrow 1/3 I_{o\text{ nom}}$				150			130			360		μs
t_d		Recovery time	IEC/EN 61204				50			50			60		
α_{V_o}	Temperature coefficient $\Delta V_o / \Delta T_C (T_{C\text{ min}} - T_{C\text{ max}})$		$V_{i\text{ min}} - V_{i\text{ max}}$ $I_o = 0 - I_{o\text{ nom}}$					± 0.02			± 0.02			± 0.02	%/K

Table 3c: Output data. General conditions as per table 3a

Output			PSB155			PSB245			PSB365			Unit
Characteristics		Conditions	min	typ	max	min	typ	max	min	typ	max	
V_o	Output voltage	$V_{i\text{nom}}, I_{o\text{nom}}$	14.91		15.09	23.68		24.14	35.78		36.22	V
I_o	Output current	$V_{i\text{min}} - V_{i\text{max}}$	0		5.0	0		5.0	0		5.0	A
I_{oL}	Output current limitation	$T_{C\text{min}} - T_{C\text{max}}$	5.0		6.5	5.0		6.5	5.0		6.5	
V_o	Output voltage noise	Switching frequency	$V_{i\text{nom}}, I_{o\text{nom}}$	40	70	45	120		70	180		mV _{pp}
		Total	IEC/EN 61204 BW = 20 MHz	44	74	50	125		75	185		
ΔV_{oV}	Static line regulation	$V_{i\text{min}} - V_{i\text{max}}, I_{o\text{nom}}$	40	75		70	150		100	200		mV
ΔV_{oI}	Static load regulation	$V_{i\text{nom}}, I_o = 0 - I_{o\text{nom}}$	30	65		70	120		120	160		
V_{od}	Dynamic load regulation	Voltage deviation	$V_{i\text{nom}}$	100		120			180			
t_d		Recovery time	$I_{o\text{nom}} \leftrightarrow 1/3 I_{o\text{nom}}$ IEC/EN 61204	60		80			100			μs
α_{Vo}	Temperature coefficient $\Delta V_o / \Delta T_C (T_{C\text{min}} - T_{C\text{max}})$	$V_{i\text{min}} - V_{i\text{max}}$ $I_o = 0 - I_{o\text{nom}}$			± 0.02			± 0.02			± 0.02	%/K

Table 3d: Output data

Output			PSB5A4			PSB123			PSB153			Unit
Characteristics		Conditions	min	typ	max	min	typ	max	min	typ	max	
V_o	Output voltage	$V_{i\text{nom}}, I_{o\text{nom}}$	5.07		5.13	11.93		12.07	14.91		15.09	V
$I_{o\text{nom}}$	Output current nominal	$V_{i\text{min}} - V_{i\text{max}}$		4.0			3.0			3.0		A
$I_{o\text{max}}$	Output current max	$V_{i\text{min}} - 80\text{V}$		5.0			4.0			4.0		
I_{oL}	Output current limitation	$T_{C\text{min}} - T_{C\text{max}}$	5.0		6.5	4.0		5.2	4.0		5.2	
V_o	Output voltage noise	Switching frequency	$V_{i\text{nom}}, I_{o\text{nom}}$	15	35	25	45		40	70		mV _{pp}
		Total	IEC/EN 61204 BW = 20 MHz	19	39	29	49		44	74		
ΔV_{oV}	Static line regulation	$V_{i\text{min}} - V_{i\text{max}}, I_{o\text{nom}}$	20	45		30	55		50	75		mV
ΔV_{oI}	Static load regulation	$V_{i\text{nom}}, I_o = 0 - I_{o\text{nom}}$	20	35		25	40		30	65		
V_{od}	Dynamic load regulation	Voltage deviation	$V_{i\text{nom}}$	100		100			100			
t_d		Recovery time	$I_{o\text{nom}} \leftrightarrow 1/3 I_{o\text{nom}}$ IEC/EN 61204	50		50			60			μs
α_{Vo}	Temperature coefficient $\Delta V_o / \Delta T_C (T_{C\text{min}} - T_{C\text{max}})$	$V_{i\text{min}} - V_{i\text{max}}$ $I_o = 0 - I_{o\text{nom}}$			± 0.02			± 0.02			± 0.02	%/K

Table 3e: Output data. General conditions as per table 3a

Output			PSB243			PSB363			PSB483			Unit
Characteristics	Conditions		min	typ	max	min	typ	max	min	typ	max	
V_o	Output voltage		$V_{i\text{nom}}, I_{o\text{nom}}$		23.86	24.14	35.78	36.22	47.71	48.29		V
$I_{o\text{nom}}$	Output current nominal		$V_{i\text{min}} - V_{i\text{max}}$		3.0			3.0			A	
$I_{o\text{max}}$	Output current max		$V_{i\text{min}} - 80\text{ V}$		4.0			4.0				
I_{oL}	Output current limitation		$T_{C\text{min}} - T_{C\text{max}}$		4.0	5.2	4.0	5.2	5.0	5.2		
V_o	Output voltage noise	Switching freq.	$V_{i\text{nom}}, I_{o\text{nom}}$		45	120	70	180	90	190		mV _{pp}
		Total	IEC/EN 61204 BW = 20 MHz		50	125	75	185	95	195		
ΔV_{oV}	Static line regulation		$V_{i\text{min}} - V_{i\text{max}}, I_{o\text{nom}}$		70	150	100	200	150	300		mV
ΔV_{oI}	Static load regulation		$V_{i\text{nom}}, I_o = 0 - I_{o\text{nom}}$		70	120	120	160	150	250		
V_{od}	Dynamic load regulation	Voltage deviation	$V_{i\text{nom}}$ $I_{o\text{nom}} \leftrightarrow 1/3 I_{o\text{nom}}$		120			140				
t_d		Recovery time	IEC/EN 61204		80			100			μs	
α_{Vo}	Temperature coefficient $\Delta V_o / \Delta T_C (T_{C\text{min}} - T_{C\text{max}})$		$V_{i\text{min}} - V_{i\text{max}}$ $I_o = 0 - I_{o\text{nom}}$		± 0.02			± 0.02			%/K	

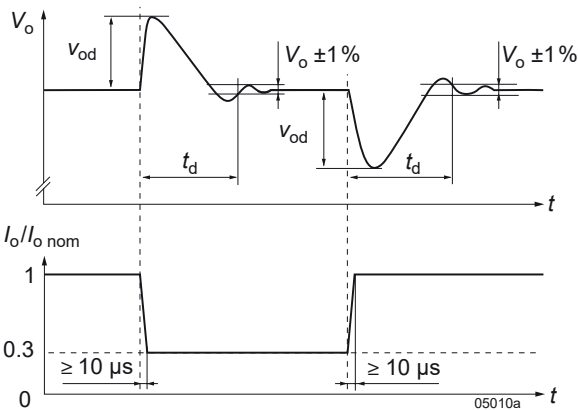

Fig. 3
Switching regulator with long supply lines.

Parallel and Series Connection

Outputs of equal nominal voltages can be parallel-connected. However, the use of a single regulator with higher output power, is always the better solution.

In parallel-connected operation, one or several outputs may operate continuously at their current limit knee-point which will cause an increase of the heat generation. Consequently, the max. ambient temperature should be reduced by 10 K.

Outputs can be series-connected with any other regulator. In series-connection the maximum output current is limited by the lowest current limitation, but electrically separated source voltages are needed for each regulator.

Thermal Considerations

When a switching regulator is located in free, quasi-stationary air (convection cooling) at a temperature $T_A = 71\text{ }^\circ\text{C}$ and is operated at $I_{o\text{nom}}$, the case temperature T_C will be about $95\text{ }^\circ\text{C}$ after the warm-up phase, measured at the measuring point of case temperature T_C ; see *Mechanical Data*.

Under practical operating conditions, T_A may exceed $71\text{ }^\circ\text{C}$, provided that additional measures (heat sink, fan, etc.) are taken to ensure that the case temperature T_C does not exceed $T_{C\text{max}}$.

The regulators with $V_{i\text{max}} = 144\text{ V}$ withstand 156 V for 2 s in order to comply with railway standards. However, $I_{o\text{max}}$ is only continuously available for $V_i \leq 80\text{ V}$ or for reduced T_A and T_C ; see fig. 4c.

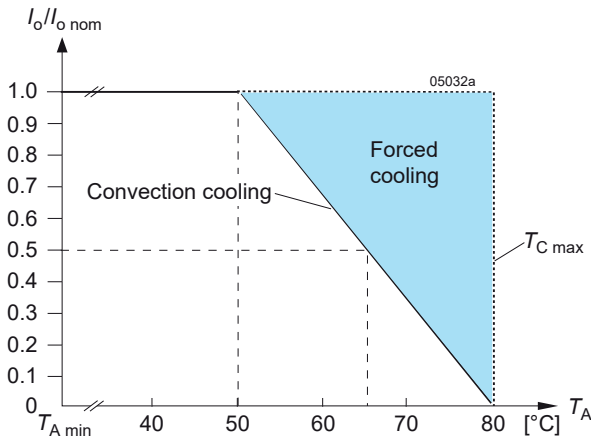

Fig. 4a
Output current vs. temperature (models -2)

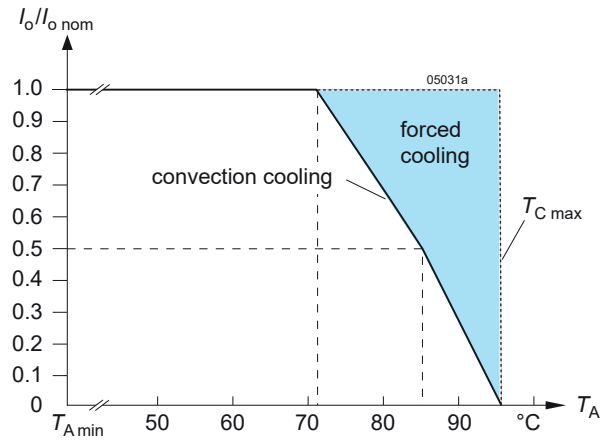

Fig. 4b
Output current vs. temp (models -7 or -9 and with $V_{i\max} \leq 80\text{ V}$)

For operation of regulators with $V_{i\max} = 144\text{ V}$ at $T_A \geq 46\text{ °C}$, an internal PTC (thermistor) starts reducing I_{oL} , if V_i is greater than 80 V. At most unfavorable conditions, I_{oL} is reduced by 1 A; see fig. 5.

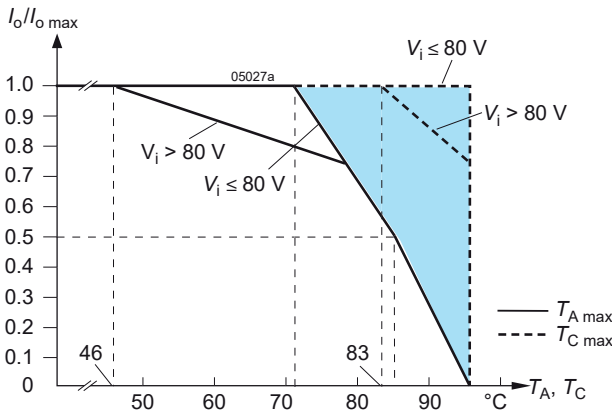

Fig. 4c
Output current vs. temperature (models with $V_{i\max} = 144\text{ V}$)

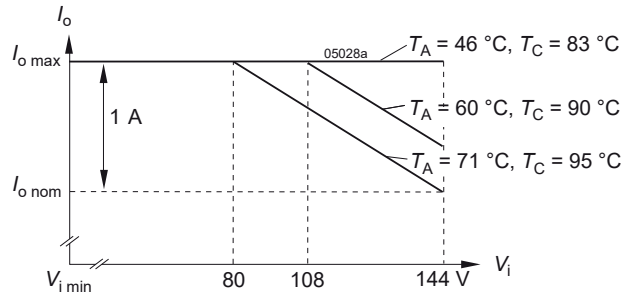

Fig. 5
Typ. dependance of I_{oL} of temperature

Output Protection and Short Circuit Behaviour

A voltage suppressor diode, which in worst case conditions fails into a short circuit (or a thyristor crowbar, option C), protects the output against an internally generated over-voltage. Such an overvoltage could occur due to a failure of either the control circuit or the switching transistor. The output protection is not designed to withstand externally applied overvoltages.

A constant current limitation circuit holds the output current almost constant, when an overload or a short circuit is applied to the output. It acts self-protecting and recovers automatically after removal of the overload or short circuit condition.

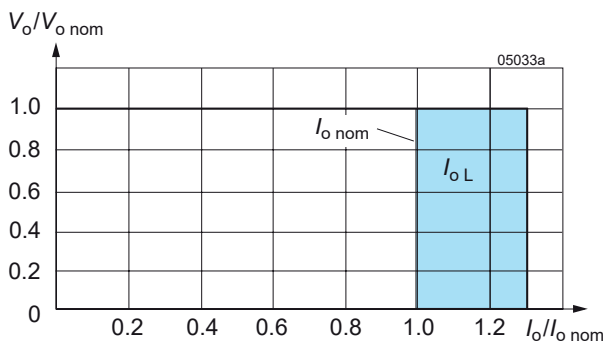

Fig. 6a
Short-circuit behaviour V_o vs. I_o for regulators with $V_{i\max} \leq 80\text{ V}$

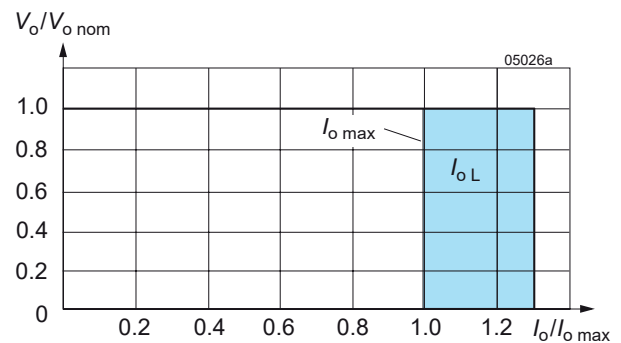

Fig. 6b
Short-circuit behaviour V_o vs. I_o for regulators with $V_{i\max} = 144\text{ V}$.

Auxiliary Functions

i Inhibit (Remote On / Off)

The inhibit input allows for disabling the switching regulator by a control signal. In systems with several converters, this feature can be used, for example, to control the activation sequence of converters by a logic signal. An output voltage overshoot will not occur at switch on.

Note: With open i-pin, the output is enabled.

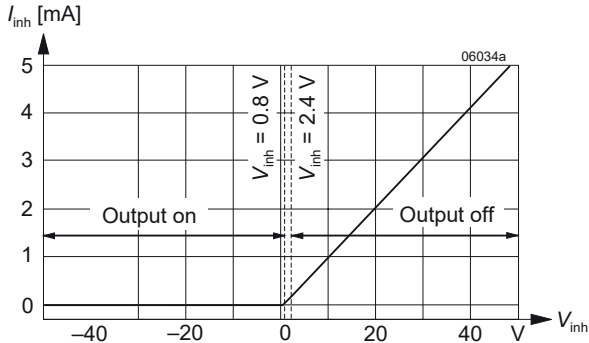

Fig. 7
Typical inhibit current I_{inh} versus inhibit voltage V_{inh}

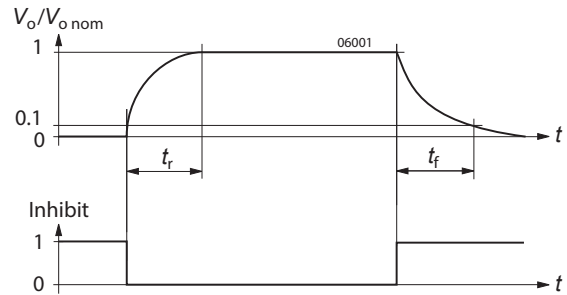

Fig. 8
Output response as a function of inhibit signal

Table 4: Inhibit characteristics

Characteristics		Conditions	min	typ	max	Unit
V_{inh}	Inhibit input voltage	$V_o = \text{on}$	$V_{i \min} - V_{i \max}$	- 50	+0.8	V
		$V_o = \text{off}$	$T_{C \min} - T_{C \max}$	+2.4	+50	
t_r	Switch-on time	$V_i = V_{i \text{ nom}}$		130		ms
t_f	Switch-off time	$R_L = V_{o \text{ nom}} / I_{o \text{ nom}}$		25		
I_{inh}	Input current when inhibited	$V_i = V_{i \text{ nom}}$		25		mA

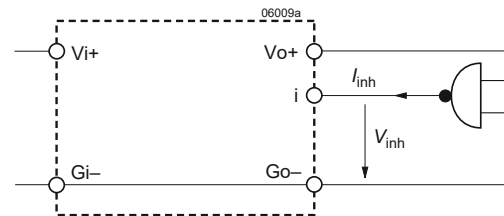

Fig. 9
Definition of I_{inh} and V_{inh}

R Output Voltage Adjust

Note: With open R input, $V_o \approx V_{o \text{ nom}}$.

The output voltage V_o can either be adjusted with an external voltage source (V_{ext}) or with an external resistor (R_1 or R_2). The adjustment range is 0 – 108% of $V_{o \text{ nom}}$. The minimum differential voltage $\Delta V_{io \text{ min}}$ between input and output (see *Electrical Input Data*) should be maintained.

$$V_{ext} \approx 2.5 \text{ V} \cdot \frac{V_o}{V_{o \text{ nom}}} \quad V_o \approx V_{o \text{ nom}} \cdot \frac{V_{ext}}{2.5 \text{ V}}$$

Caution: To prevent damage, V_{ext} should not exceed 20 V, nor be negative.

b) $V_o = 0$ to $V_{o \text{ nom}}$, using R_{ext1} between pins R and G:

$$R_{ext1} \approx \frac{4000 \Omega \cdot V_o}{V_{o \text{ nom}} - V_o} \quad V_o \approx \frac{V_{o \text{ nom}} \cdot R_{ext1}}{R_{ext1} + 4000 \Omega}$$

c) $V_o = V_{o \text{ nom}}$ to $V_{o \text{ max}}$, using R_{ext2} between pins R and G:

$$R_{ext2} \approx \frac{4000 \Omega \cdot V_o \cdot (V_{o \text{ nom}} - 2.5 \text{ V})}{2.5 \text{ V} \cdot (V_o - V_{o \text{ nom}})}$$

$$V_o \approx \frac{V_{o \text{ nom}} \cdot 2.5 \text{ V} \cdot R_{ext2}}{2.5 \text{ V} \cdot (R_{ext2} + 4000 \Omega) - V_{o \text{ nom}} \cdot 4000 \Omega}$$

Caution: To prevent damage, R_{ext2} should never be less than 47 k Ω .

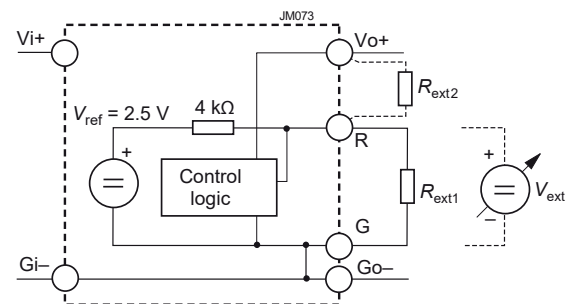

Fig. 10
Output voltage adjustment via R-input

LED Output Voltage Indicator

A yellow LED indicator is illuminated, when the output voltage is higher than approx. 3 V (not for -2 models).

Electromagnetic Compatibility (EMC)

Electromagnetic Immunity

Table 8: Electromagnetic immunity type tests

Phenomenon	Standard	Level	Coupling mode ¹	Value applied	Waveform	Source imped.	Test procedure	In oper.	Perf. crit. ²
Electrostatic discharge	IEC/EN 61000-4-2	3 ³	contact discharge	6000 V _p	1/50 ns	330 Ω	10 pos. & 10 neg. discharges	yes	B
			air discharge	8000 V _p					
Electromagnetic field	IEC/EN 61000-4-3	x	antenna	20 V/m	AM 80% / 1 kHz	N/A	80 – 1000 MHz	yes	A
			antenna	20 V/m	AM 80% / 1 kHz	N/A	800 – 1000 MHz	yes	A
				10 V/m					
				5 V/m					
				3 V/m					
Electrical fast transients / burst	IEC/EN 61000-4-4	3 ³	i/c, +i/-i	2000 V _p	bursts of 5/50 ns; 5 kHz repet. rate; transients with 15 ms burst duration; 300 ms period	50 Ω	60 s positive 60 s negative transients per coupling mode	yes	A ⁴
Surges	IEC/EN 61000-4-5	3 ³	i/c	± 2000 V _p	1.2 / 50 μs	42 Ω 0.5 μF	5 pos. & 5 neg. surges per coupling mode	yes	A ⁴
			+i/-i	± 1000 V _p					
Conducted disturbances	IEC/EN 61000-4-6	3 ³	i, o, signal wires	10 VAC ³	AM 80% / 1 kHz	150 Ω	0.15 – 80 MHz	yes	A

¹ i = input, o = output, c = case.

² A = Normal operation, no deviation from specifications, B = Normal operation, temporary loss of function or deviation from specs possible

³ Not applicable for -2 models

⁴ Option L necessary; with option C, manual reset might be necessary.

Electromagnetic Emission

For emission levels refer to *Electrical Input Data*.

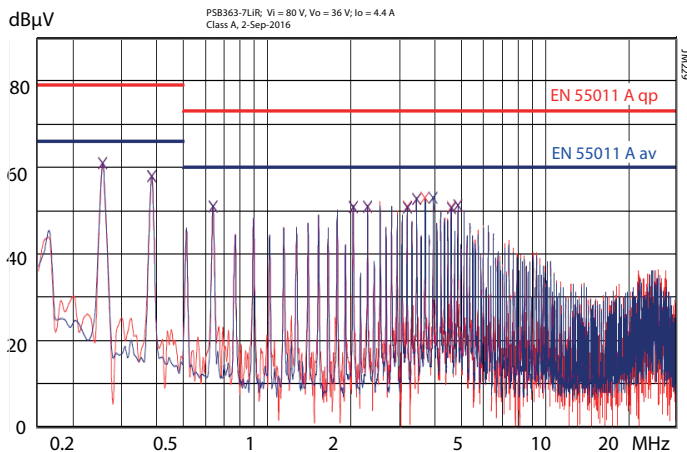

Fig. 11

Typical disturbance voltage (quasi-peak) at the input as per EN 55011, measured at $V_{i\text{nom}}$, $I_{o\text{nom}}$, PSB363-7LiR

Immunity to Environmental Conditions

Table 6: Mechanical and climatic stress

Test method		Standard	Test Conditions		Status
Cab	Damp heat steady state	IEC/EN 60068-2-78 MIL-STD-810D section 507.2	Temperature:	40 ^{±2} °C	Regulator not operating
			Relative humidity:	93 ^{+2/-3} %	
Duration:	56 days				
Ea	Shock (half-sinusoidal)	IEC/EN 60068-2-27 MIL-STD-810D section 516.3	Acceleration amplitude:	50 g _n = 490 m/s ²	Regulator operating
			Bump duration:	11 ms	
			Number of bumps:	18 (3 in each direction)	
Fc	Vibration (sinusoidal)	IEC/EN 60068-2-6 MIL-STD-810D section 514.3	Acceleration amplitude:	0.35 mm (10 – 60 Hz)	Regulator operating
				5 g _n = 49 m/s ² (60 - 2000 Hz)	
			Frequency (1 Oct/min):	10 – 2000 Hz	
			Test duration:	7.5 h (2.5 h in each axis)	
Fda	Random vibration wide band Reproducibility high	IEC/EN 60068-2-35 DIN 40046 part 23	Acceleration spectral density:	0.05 g _n ² /Hz	Regulator operating
			Frequency band:	20 to 500 Hz	
			Acceleration magnitude:	4.9 g _{n rms}	
			Test duration:	3 h (1 h in each axis)	
Kb	Salt mist cyclic (sodium chloride NaCl solution)	IEC/EN 60068-2-52	Concentration:	5 % (30 °C)	Regulator not operating
			Duration:	2 h per cycle	
			Storage:	40 °C, 93% rel. humidity	
			Storage duration:	22 h per cycle	
		Number of cycles:	3		

Temperatures

Table 7: Temperature specifications, valid for air pressure of 800 to 1200 hPa (800 to 1200 mbar)

Temperature			-2			-7			-9 (Option)			Unit
Characteristics	Conditions	min	typ	max	min	typ	max	min	typ	max		
T _A	Ambient temperature ¹	Regulator operating ¹	- 10		50	- 25		71	- 40		71	° C
T _C	Case temperature		- 10		80	- 25		95	- 40		95	
T _S	Storage temperature ¹	Not operational	- 25		100	- 40		100	- 55		85	

¹ See *Thermal Considerations* and *Overtemperature Protection*.

Reliability

Table 8: Typical MTBF and device hours

MTBF Case temperature	Ground benign	Ground fixed		Ground mobile	Device hours ¹
	T _c = 40 °C	T _c = 40 °C	T _c = 70 °C	T _c = 50 °C	
MTBF accord. to MIL-HDBK-217F	625 000 h	207 000 h	96 000 h	46 000 h	13 000 000 h

¹ Statistical values, based on an average of 4300 working hours per year and in general field use

Mechanical Data

Dimensions in mm.

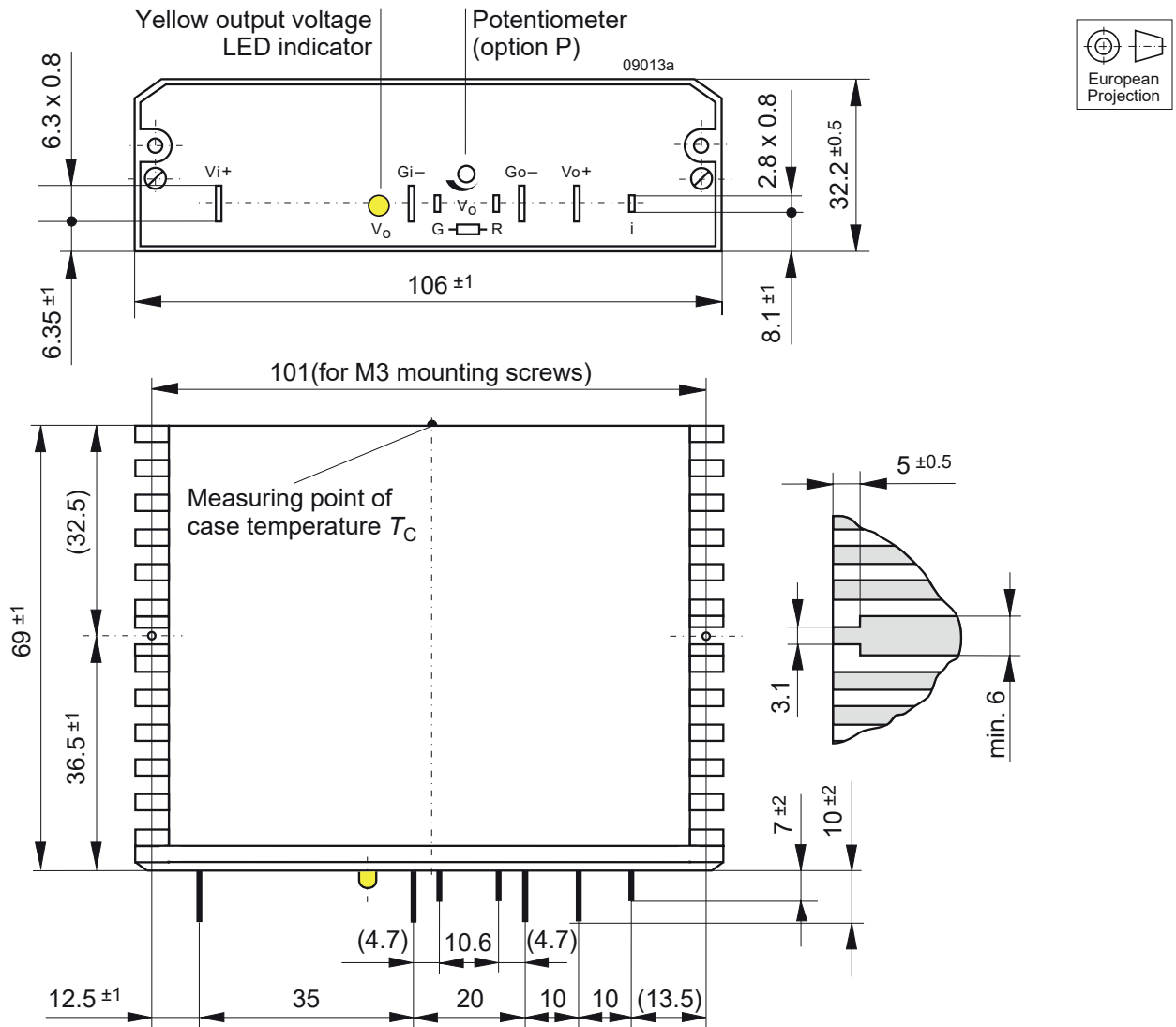

Fig. 12
Case B02, weight 230 g
Aluminum, black finish (EP powder coated), self cooling

Safety and Installation Instructions

Installation Instruction

Installation must strictly follow the national safety regulations in compliance with the enclosure, mounting, creepage, clearance, casualty, markings, and segregation requirements of the end-use application.

Check for hazardous voltages before connecting.

The input and the output circuit are not separated, i.e., the negative path is internally interconnected.

Do not open the regulator !

Ensure that a regulator failure (e.g., by an internal short-circuit) does not result in a hazardous condition.

Cleaning Liquids and Protection Degree

In order to avoid possible damage, any penetration of cleaning fluids must be prevented, since the power supplies are not hermetically sealed.

The protection degree is IP 30 (IP 20 with option P).

Standards and Approvals

All switching regulators have been approved according to the latest edition of IEC/EN 60950-1 and UL/CSA60950-1.

The regulators have been evaluated for:

- Building in
- The use in a pollution degree 2 environment
- Connecting the input to a secondary circuit, which is subject to a maximum transient rating of 1500 V.

The switching regulators are subject to manufacturing surveillance in accordance with the above mentioned standards and with ISO 9001:2015.

Isolation

Electric strength test voltage between input connected with output against case: 1500 VDC, 10 s (for some PSB models only with version V103 or higher).

These tests are performed in the factory as routine test in accordance with EN 50514 and IEC/EN 60950. The electric strength test should not be repeated by the customer.

Railway Application

The regulators have been developed observing the railway standards EN 50155 and EN 50121. All boards are coated with a protective lacquer.

Description of Options

-9 Extended Temperature Range

This option defines an extended temperature range as specified in table 7.

P Potentiometer

Note: Option P is not recommended, if several regulators are operated in parallel connection.

Option P excludes R function; the R-input (pin 16) should be left open-circuit. The output voltage V_o is preset to 108 % of $V_{o\text{nom}}$ and can be adjusted in the range 90 – 108% of $V_{o\text{nom}}$.

However, the minimum differential voltage $\Delta V_{i\text{omin}}$ between input and output specified in *Electrical Input Data* should be observed.

L Input Filter

Option L is recommended to reduce superimposed interference voltages and to prevent oscillations, if input lines exceed the length of approx. 5 m in total. The fundamental wave (approx. 120 kHz) of the reduced interference voltage between V_{i+} and G_{i-} has, with an input line inductance of 5 μH , a maximum magnitude of 4 mVAC.

The input impedance of the switching regulator at 120 kHz is about 3.5 Ω . The harmonics are small in comparison with the fundamental wave.

With option L, the maximum permissible additionally superimposed ripple v_i of the input voltage (rectifier mode) at a specified input frequency f_i has the following values:

$$V_{i\text{max}} = 10 V_{\text{pp}} \text{ at } 100 \text{ Hz or } V_{\text{pp}} = 1000 \text{ Hz} / f_i \times 1 \text{ V}$$

C Thyristor Crowbar

Option C protects the load against power supply malfunction. It is not designed to sink external currents. A fixed-value monitoring circuit checks the output voltage V_o . When the trigger voltage V_{oc} (see table 9) is reached, the thyristor crowbar triggers and disables the output. It can be deactivated by removal of the input voltage. In case of a defect switching transistor, the internal fuse prevents excessive current.

Type of the fuse:

- Regulators with $I_{o\text{nom}} = 3 \text{ A}$: 5 A / 250 V, slow, 5 × 20 mm
- Regulators with $I_{o\text{nom}} > 3 \text{ A}$: 8 A / 250 V, slow, 5 × 20 mm

Note: The crowbar can be reset by removal of the input voltage only. The inhibit signal cannot deactivate the thyristor.

Table 9: Crowbar trigger levels

Characteristics		Conditions	$V_o = 5.1 \text{ V}$			$V_o = 12 \text{ V}$			$V_o = 15 \text{ V}$			$V_o = 24 \text{ V}$			$V_o = 36 \text{ V}$			Unit
			min	typ	max	min	typ	max	min	typ	max	min	typ	max	min	typ	max	
V_{oc}	Trigger voltage	$T_{C\text{min}} - T_{C\text{max}}$	5.8		6.8	13.5		16	16.5		19	27		31	40		45	V
t_s	Delay time	$V_{i\text{min}} - V_{i\text{max}}$ $I_o = 0 - I_{o\text{nom}}$			1.5			1.5			1.5			1.5			1.5	μs

G RoHS Compliance

Models with G are RoHS-compliant for all six substances.

Accessories

A variety of electrical and mechanical accessories are available, including:

- Insulation plate HZZ01205-G for easy and safe PCB-mounting; see fig. 13.
- Solder-tags for direct mounting of the regulator to a PCB board; see fig. 14.
- Ring core chokes for ripple and interference reduction.
- Battery sensor [S-KSMH...] for using the regulator as battery charger. Different cell characteristics can be selected; see Temperature Sensor Data Sheet BCD20024 on our web site.

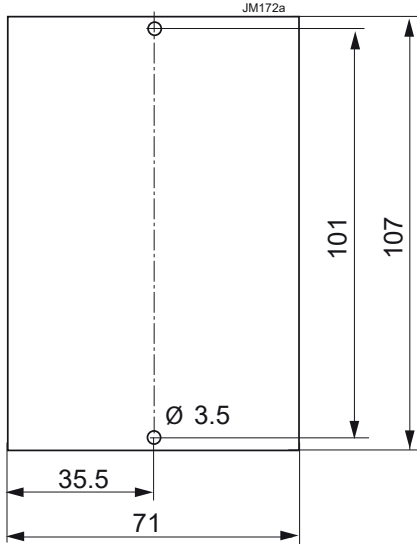

Fig. 13
Insulation plate HZZ01205-G
0.3 mm thick

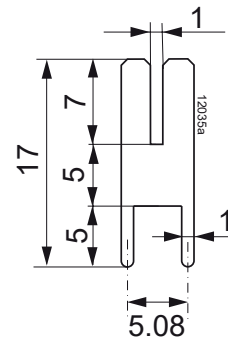

Fig. 14
Solder tag HZZ01204-G
Delivery content: 10 pieces

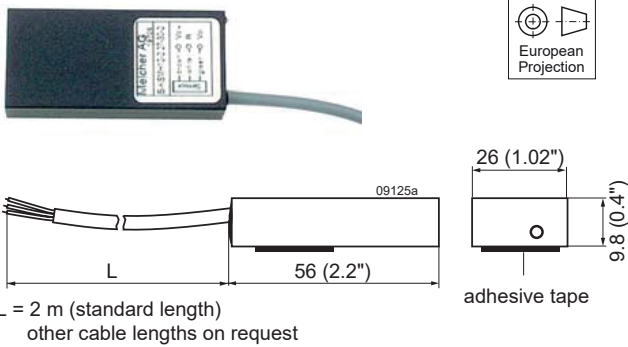

Fig. 15
Battery temperature sensor

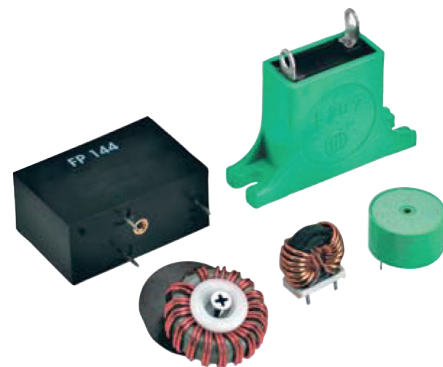

Fig. 16
Different filters

For additional accessory product information, see the accessory data sheets listed with each product series at our web site.

NUCLEAR AND MEDICAL APPLICATIONS - These products are not designed or intended for use as critical components in life support systems, equipment used in hazardous environments, or nuclear control systems.

TECHNICAL REVISIONS - The appearance of products, including safety agency certifications pictured on labels, may change depending on the date manufactured. Specifications are subject to change without notice.