



DC100 Digital Dispenser Operating Manual

Table of Contents

Product Safety Statement	4
Specifications	6
Accessories	6
External Controls	7
Machine Setup	8
Dispense Setup	9
Operation	10
Controls	11
Dispense Modes	13
• Purge Mode	13
• Teach Mode	14
• Timed Mode	15
• Time+ Mode	16
• Int Mode	17
Function Menu	18
• Unlock / Lock	19
• Add Dispense Time	20
• Glue Alarm	21
• Pressure Alarm	23
• Vacuum Alarm	24
• Auto Purge	26
• Power Switch	27
• Dispense Count	27
• Dispense Time	28
• Used Time	28
Calibration	29
• Pressure Regulator Calibration	30
• Vacuum Regulator Calibration	31
External Control	32
• I/O Connections	32
• I/O Schematic	33
• Multiple Dispensers	34

OVERVIEW











Model DC100 Digital Dispenser

The DC100 digital dispenser, with its versatile design, makes it perfectly suited for a wide variety of dispensing applications; from microdot deposits, to large potting and filling.

- Adjustable air output pressure and vacuum function with digital display.
- A multi-purpose, programmable alarm timer to disable the dispenser after a specific amount of time – useful for automated applications and materials with shortened shelf life and/or pot life (i.e. two-component, pre-mixed frozen, etc.).
- Tolerance on the input air pressure can be set to ensure consistent pressure all throughout the dispensing.

SAFETY

-  **Do not operate the unit in excess of its maximum ratings / settings.**
-  **Make sure that the input air supply is clean and dry.**
-  **If corrosive or flammable fluids are being used, an inline filter must be installed to help prevent the fluids from being sucked back into the unit.**
-  **The fluid being dispensed may be toxic and / or hazardous. Refer to the Material Safety Data Sheet for proper handling and safety precautions.**
-  **Do not smoke or use near an open flame when flammable materials are being dispensed.**
-  **Do not expose the dispenser directly to sunlight.**
-  **Avoid cleaning the dispenser with aggressive solvents – neutral detergents are preferred.**
-  **Do not overfill the barrel and/or lay the barrel on its side. This will prevent fluids from flowing back into the unit – refer to figures A & B below.**

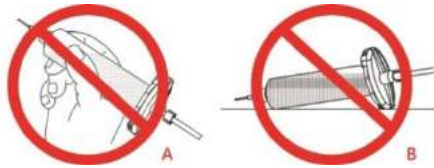





DC100 Malfunction

-  **If the DC100 malfunctions, shut down the unit immediately. This can be done by either pressing the power switch or disconnecting the power cord.**





Inappropriate Use

If the DC100 is used in a way other than described in this manual, it may cause damage to self or property.

- | | |
|---|---|
|  | <i>Do not use any components with the DC100 other than Fisnar authorized components.</i> |
|  | <i>Do not use incompatible materials.</i> |
|  | <i>Do not make any modifications to the DC100.
All repairs are to be done by Fisnar trained employees.</i> |
|  | <i>Do not operate the unit in excess of its maximum ratings / settings.</i> |





Fire Prevention

Refer to the following instructions to avoid any fire or explosion.

- | | |
|---|--|
|  | <i>Access your surroundings and the location of the nearest fire extinguisher and Emergency Exit.</i> |
|  | <i>Do not smoke or use near an open flame when flammable materials are being dispensed.</i> |
|  | <i>Immediately disconnect power if any sparking or smoke appears.</i> |
|  | <i>Do not expose the dispenser directly to sunlight.</i> |

Maintenance

The DC100 is generally a maintenance free dispenser. However, to ensure smooth operation please follow the below instructions.

- | | |
|---|--|
|  | <i>Only use non-woven cleaners on the LCD.</i> |
|  | <i>Avoid cleaning the dispenser with aggressive solvents – neutral detergents are preferred.</i> |
|  | <i>Ensure that compressed air supply to the DC100 is clean and moisture free.</i> |
|  | <i>Do not lay the barrel on its side. This will prevent fluids from flowing back into the unit.</i> |

SPECIFICATIONS

Dimensions:	180 x 195 x 80 (W x D x H mm)
Weight:	0.9 KG (1.9 lbs.)
Input Voltage:	100 – 240 VAC
Rated Power:	18W
Cycle Rate:	600+/min
Relative Humidity:	20 – 90% (no condensation)
Operating Temperature:	10 – 40°C (50 – 104°F)
Timer:	0.008s – 9999s
Air Input:	100 psi (7 bar) max
Air Output:	0 – 100 psi (7 bar)

ACCESSORIES

Item	Quantity
Power Adapter (Input: 100 – 240 VAC / Output: 24 VDC)	1
Foot Pedal	1
Air Inlet Hose	1
Syringe Holder	1
Push To Connect Tube Fitting 1/4" Stem OD X 5/32" Tube OD	1
Push Tube Fitting 1/4" OD Tube x1/8" NPT	1

- Note: Consumable kit (part # QK-CSK) & needle sample kit (part # QK-NSK) available to purchase separately.



Part # QK-CSK



Part # QK-NSK

EXTERNAL CONTROLS

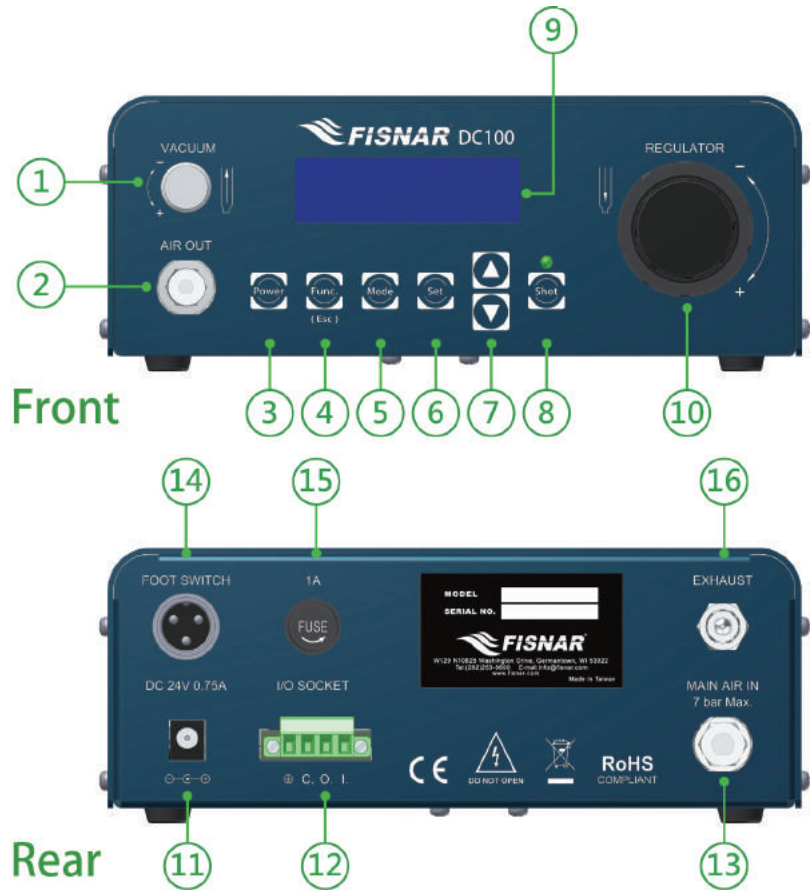

FIG. 1: External Controls

Item	Illustration	Item	Illustration	Item	Illustration
1	Vacuum Control	7	Scroll Buttons	13	Air Inlet Port
2	Air Outlet Port	8	Shot / Purge Button	14	Foot Switch Connector
3	Power Button	9	Display	15	Fuse
4	Function / Escape Button	10	Air Pressure Regulator	16	Exhaust Port
5	Mode Button	11	Power Input Connector		
6	Set Button	12	I/O Connector		

MACHINE SET UP

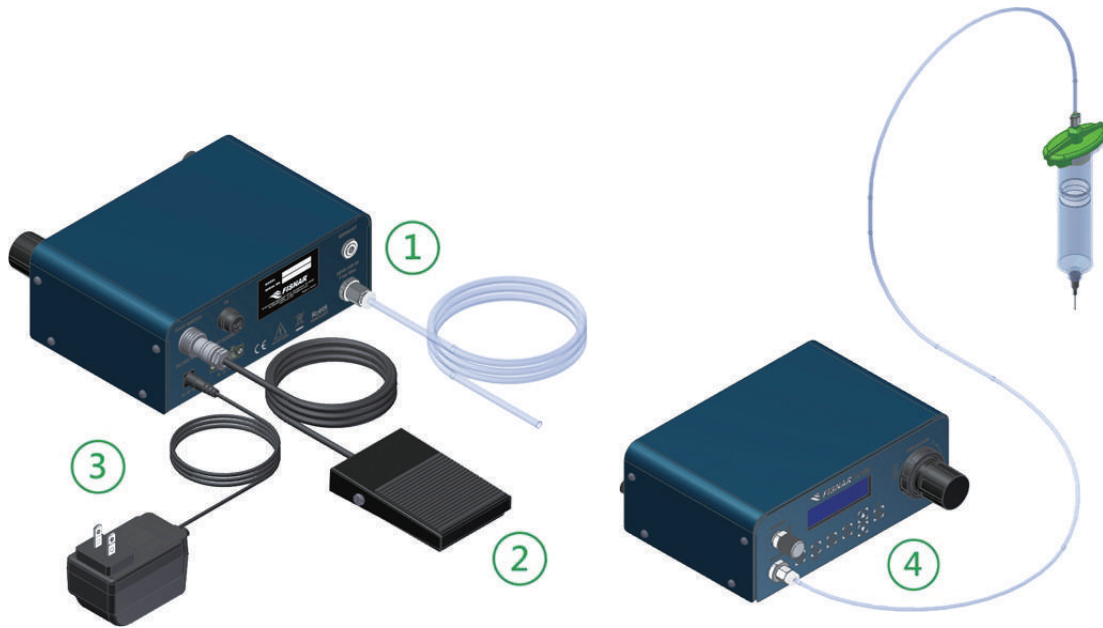



FIG. 2: Front and Back Views

1. Connect air hose (1) from compressed air 70-100psi (5-7 bar) to the air inlet port on the back of the dispenser. See FIG. 2.
2. Insert the Foot Switch connector (2) to the port on the back of the dispenser. See FIG. 2.
3. Connect Electrical Power Cord (3) to the port on the back of the dispenser. See FIG. 2.

DISPENSE SETUP

- Fill the barrel (with barrel tip cap on the barrel) with material to be dispensed. Attach barrel to barrel adapter head as shown below. See FIG. 3.

 **Do not overfill the barrel and/or lay the barrel on its side. This will prevent fluids from flowing back into the unit – refer to figures A & B below.**

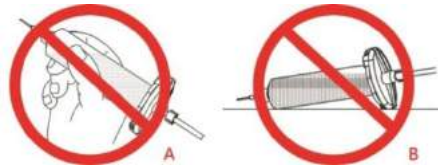

- Connect the barrel adapter air tube with the “Air Out” port on the front of the dispenser. (4) See FIG. 2.

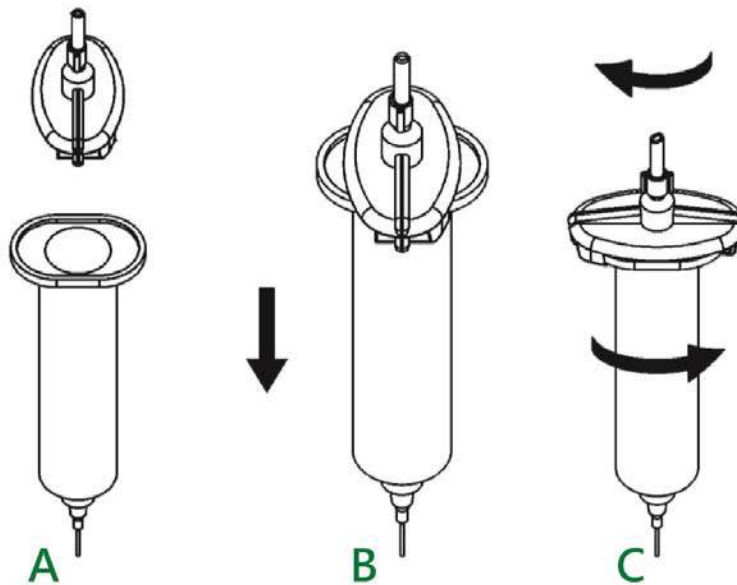
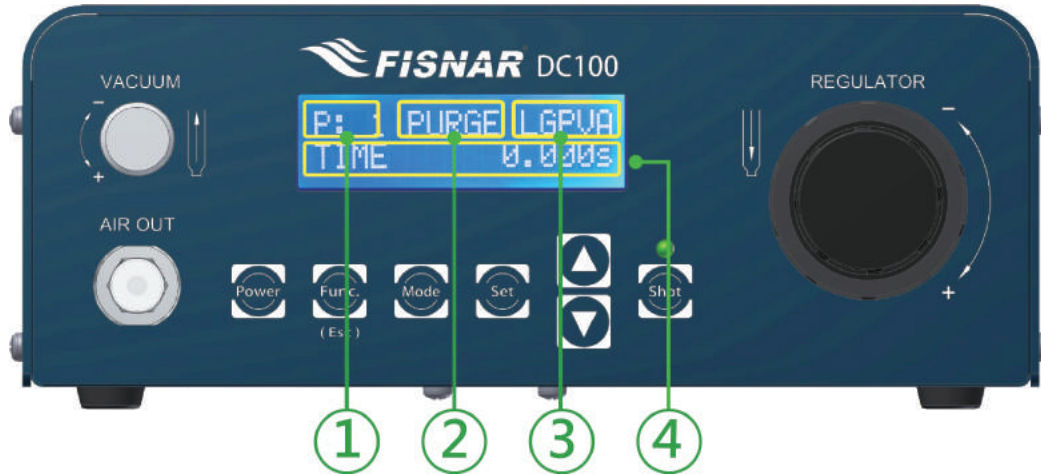

FIG. 3: Dispenser Set Up

OPERATION



Main Screen Display

1	Program	Displays the currently selected program. Up to ten (10) individual programs can be saved to the DC100 for future recall.
2	Mode	Displays the current mode the saving program is in. There are five (5) dispense modes available: PURGE, TEACH, TIMED, TIME+ and INT.
3	Features	Displays which feature(s) are currently turned ON (i.e. Lock, Glue Alarm, Pressure Alarm, Vacuum Alarm and Auto Purge).
4	Parameters	Displays the values of the saved parameters (i.e. dispensing time, pressure and vacuum).

CONTROLS















Power On	Press the  key when the machine is OFF to turn the machine ON.
Power Off	Press the  key when the machine is ON to save everything and turn the machine OFF.
Switch Modes	Press the  key to set the program to the required dispense mode (i.e. PURGE, TEACH, TIMED, TIME+, INT).
Set Parameters	Press the  key to scroll through the dispense parameter settings (i.e. TIME, PRES and VAC).
Switch Programs	Press the  keys to switch programs – see below.





FIG. 4: Controls

Set Pressure	Press the  key to display the current setting. Turn the regulator knob clockwise to increase the pressure as needed.
Set Vacuum	Press the  key to display the current setting. Turn the vacuum knob clockwise to increase the vacuum as needed.
Switch Units	Press the  keys while adjusting pressure or vacuum to switch between pressure unit displays (i.e. psi, kgf/cm ² , MPa, kPa and bar).

CONTROLS

<p>Set Time/Interval</p>	<p>Press the  key to display the current setting. Press the   keys to change the time values. Note that the time can only be set under TIMED, TIME+ or INT modes.</p> <p>Press the  key again to choose which decimal place to edit, including the position of the decimal point.</p> <p>Press and hold the  key to save.</p> <div style="text-align: center; margin: 20px 0;">  </div> <p style="text-align: center;">FIG. 5: Controls</p>
---------------------------------	--

<p>Enter Function Menu</p>	<p>Press the  key to enter the function menu.</p>
<p>Dispense Shot</p>	<p>Press the  key to run the currently selected program and actuate the machine.</p>

DISPENSE MODES

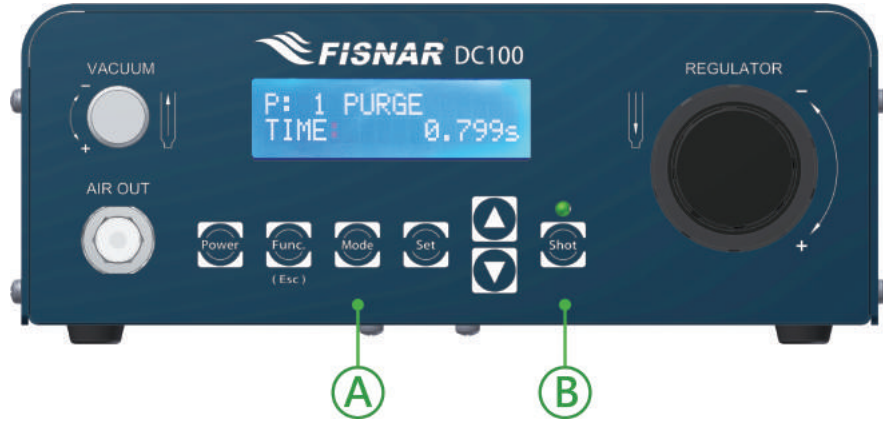



FIG. 6: Dispense Modes

PURGE MODE	
A	Use the  key to switch to PURGE mode. PURGE mode allows the operator to activate the machine on demand whenever the dispense signal is tripped (i.e. foot pedal is pressed).
B	Press the foot pedal or the  key to start the machine. Release to stop. The TIME shown will reset to zero (0) seconds every time the machine is cycled.

DISPENSE MODES

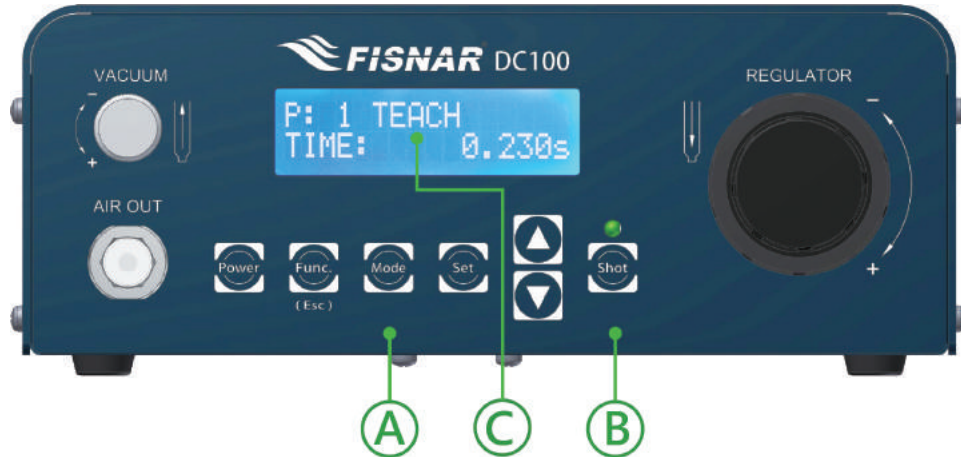





FIG. 7: Dispense Modes

TEACH MODE	
A	Use the  key to switch to TEACH mode. TEACH mode allows the operator to record the dispense time.
B	Press the foot pedal or the  key to start the machine. Release to stop. The TIME shown will be cumulative from every time the machine is cycled. Press and hold the  key to reset the timer to zero (0).
C	The time shown on the screen will be the total time the machine is cycled. Once the time required is obtained, switch to TIMED, TIME+ or INT mode to save the value.

DISPENSE MODES

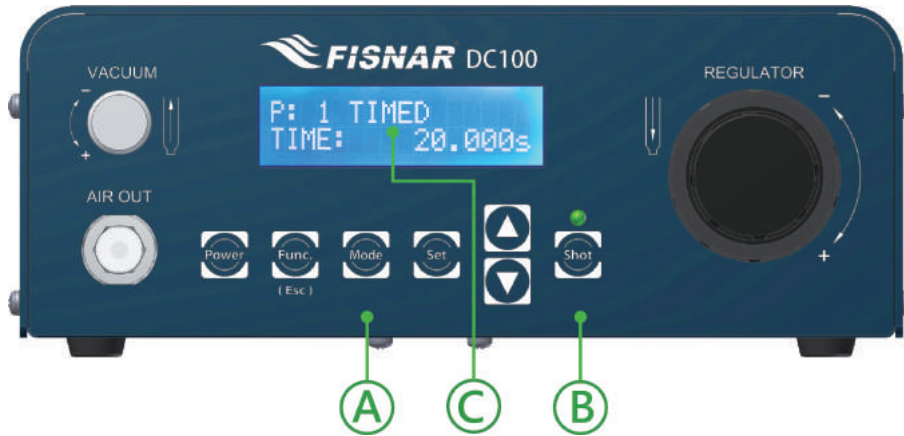

FIG. 8: Dispense Modes

TIMED MODE

<div style="font-size: 2em; font-weight: bold;">A</div> , <div style="font-size: 2em; font-weight: bold;">C</div>	<p>Use the key to switch to TIMED mode.</p> <p>TIMED mode allows the operator to dispense material at a fixed time interval.</p> <p>Press the keys to change the time values.</p> <p>Press the key again to choose which decimal place to edit, including the position of the decimal point.</p> <p>Press and hold the key to save.</p>
<div style="font-size: 2em; font-weight: bold; border: 1px solid green; border-radius: 50%; padding: 5px;">B</div>	<p>Press the foot pedal or the key to start the machine. The machine will continue dispensing until the set time is satisfied.</p> <p>Pressing the key will stop the dispensing regardless of whether the set time is up or not. This shot will be considered “incomplete” and will not count towards the cumulative dispense counter. The timer will reset to the original programmed time value.</p>

DISPENSE MODES

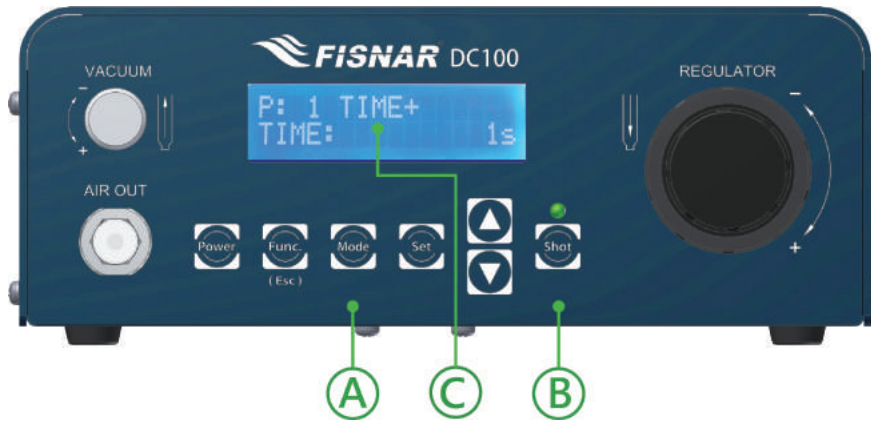







FIG. 9: Dispense Modes

TIME+ MODE

A	<p>Use the  key to switch to TIME+ mode.</p> <p>TIME+ mode allows the operator to program a second timed shot, useful for making slight adjustments on the dispense time without changing the original value in TIMED mode.</p> <p>This mode is suitable for sensitive (temperature, humidity, short pot life, etc.) materials that require tweaking of the timed value (or pressure) over time to achieve consistency on the dispensed amount.</p> <p>Press the   keys to change the value.</p>
B	<p>Press the foot pedal or the  key to start the machine. The machine will continue dispensing until the set time is satisfied.</p> <p>Pressing the  key will stop dispensing regardless of whether set time is up or not. This shot will be considered “incomplete” and will not count towards the cumulative dispense counter. The timer will reset to the original programmed time value.</p>
C	<p>The time value saved under TIME+ mode will not affect the values in other modes (i.e. TIMED, INT). However, changing the time value in other modes will also change the value in TIME+ mode.</p>

DISPENSE MODES

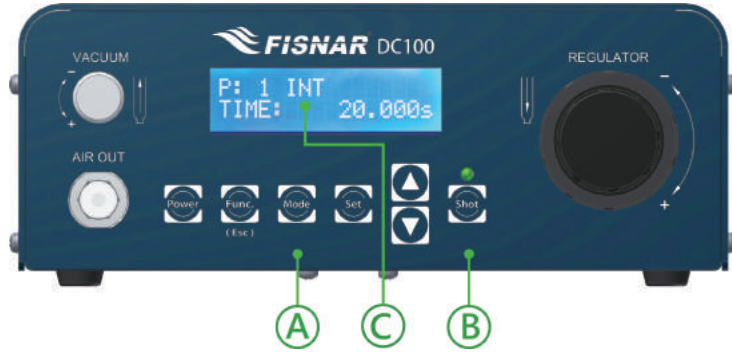







FIG. 10: Dispense Modes

INT MODE	
<div style="font-size: 2em; font-weight: bold; color: green;">A, C</div>	<p>Use the key to switch to INT mode.</p> <p>INT mode allows the operator to control the material being dispensed within the programmed dispense time interval. This combines the precision of a timed shot with the flexibility of an operator control shot.</p> <p>Press the keys to change the time values.</p> <p>Press the key again to choose which decimal place to edit, including the position of the decimal point.</p> <p>Press and hold the key to save.</p>
<div style="font-size: 2em; font-weight: bold; color: green;">B</div>	<p>Press the foot pedal or the key to start the machine. Release to stop. The timer will continue to count down until, either: (1) the foot pedal is released, or; (2) the set time is satisfied.</p> <p>The timer will only reset to the original programmed time value once it reaches zero (0).</p> <p>A full shot cycle is counted towards the cumulative dispense counter whenever the timer reaches zero (0).</p>

FUNCTION MENU

The DC100 controller offers built-in functions that provide additional control to any dispensing application.

Instructions:

- Press the  key to enter the Function menu.
- Press the   keys to scroll through the available built-in functions.
- Press the  key to enter the selected function menu.
- Press the  key to exit.

Overview:

Function	Description
1. Unlock / Lock	Locks or unlocks the controls.
2. Add Dispense Time	Sets the amount of time added to the TIME+ value after a predetermined number of shots.
3. Glue Alarm	Sets the total amount of dispense time required to empty the barrel or cartridge.
4. Pressure Alarm	Sets the pressure and tolerance required for optimum dispensing conditions.
5. Vacuum Alarm	Sets the vacuum and tolerance required for optimum dispensing conditions.
6. Auto Purge	Sets the dispense time and delay time for automatic purging of material.
7. Power Switch	Unit is turned on by power being supplied to it instead of using the on/off switch.
8. Dispense Count	Displays the total number of dispensed shots made per work cycle. This counter is resettable.
9. Dispense Time	Displays the total dispense time made per work cycle. This timer is resettable.
10. Used Time	Displays the total number of hours the machine is being used. This timer is not resettable.

FUNCTION MENU

1. Unlock / Lock

This function allows the user to lock the dispenser controls so it cannot be inadvertently modified. Only the  button will function if the lock is engaged.



FIG. 11: Unlock/Lock Function



1. There is only one (1) parameter required for this function: MODE. Use the   buttons to toggle between locked and unlocked state. See FIG. 11.



FIG. 12: Locked

2. A letter “L” will show on the main screen when the machine is locked. See FIG. 12.

FUNCTION MENU

2. Add Dispense Time

This function allows the user to program a cumulative time offset added to the original timed shot after a predetermined number of shots were made. This functionality is particularly useful to control the dispensed material amount as the barrel or cartridge empties over time.

This function is used in conjunction with the TIME+ mode.



FIG. 13: Add Dispense Time











1. There are three (3) parameters required for this function: MODE, Trigger Count and Add Time. Press the  key to scroll through these parameters.
2. Use the   keys to turn the Add Dispense Time MODE On or Off.
3. Use the   keys to set the Trigger Count value (predetermined number of shots). Press and hold the  key to save.
4. Use the   keys to set the Add Time value. Press the  key again to choose which decimal place to edit, including the position of the decimal point. Press and hold the  key to save.
5. A plus “+” symbol will show on the main screen when this function is turned ON.



FIG. 14: Add Dispense Time









FUNCTION MENU

3. Glue Alarm

This function allows the user to set a timer that will trigger a visual and audible alarm to indicate when the material is either no longer useable, or its optimal working life has been reached. This functionality is particularly useful for sensitive (moisture, temperature, light, etc.) or multi-component materials which have strict pot-life or working life dispensing requirements.





FIG. 15: Glue Alarm

- | | |
|-----------|---|
| 1. | There are three (3) parameters required for this function: <u>MODE</u> , <u>Reset Time</u> and <u>Glue Time</u> . Press the  key to scroll through these parameters. |
| 2. | Use the   keys to turn the Glue Alarm <u>MODE</u> On or Off. |
| 3. | <u>Reset Time</u> shows the time left before the alarm sounds. Press and hold the  key while under <u>Reset Time</u> to reset the timer. |
| 4. | Use the   keys to set the <u>Glue Time</u> value. Press the  key again to choose which decimal place to edit, including the position of the decimal point. Press and hold the  key to save. |
| 5. | A letter "G" will show on the main screen when this function is turned ON. |

FUNCTION MENU



FIG. 16: Glue Alarm

6. Once the Glue Time has been reached, the letter “G” on the display will start blinking (see FIG. 16), and the  key indicator light will turn ON. See FIG. 17. Pressing the  button or stepping on the foot pedal at this point will trigger an alarm.

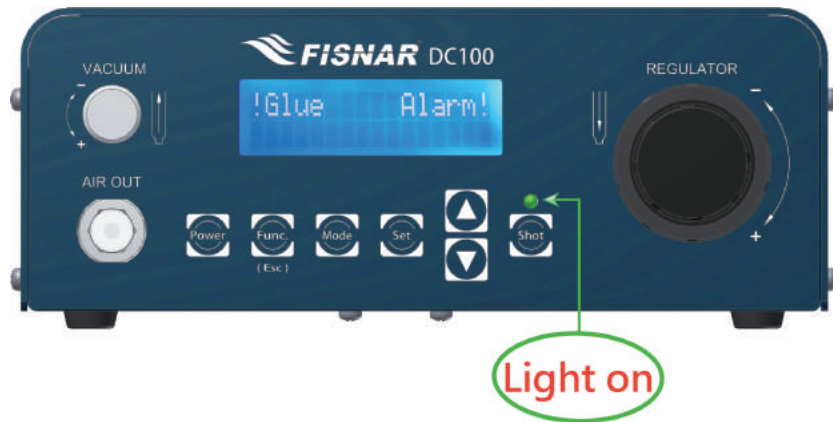



FIG. 17: Alarm Timer

7. Press the  key to clear the alarm screen. Reset the alarm timer.











FUNCTION MENU

4. Pressure Alarm

This function allows the user to set a pressure value threshold (as well as a corresponding percentage tolerance) before the machine can be operated. A visual and audible alarm will trigger if the pressure is not within tolerance.



FIG. 18: Pressure Alarm

1. There are three (3) parameters required for this function: MODE, Pressure and Tolerance. Press the  key to scroll through these parameters.
2. Use the   keys to turn the Pressure Alarm MODE On or Off.
3. Use the   keys to set the required Pressure. Press and hold the  key to save the current pressure setting.
4. Use the   keys to set the required Tolerance.
5. A letter "P" will show on the main screen when this function is turned ON.
6. Whenever the pressure value is outside of its tolerance, the letter "P" on the display will start blinking, and the  key indicator light will turn ON. Pressing the  button or stepping on the foot pedal at this point will trigger an alarm.
7. Press the  key to clear the alarm screen. Check the inlet pressure and adjust it as needed.

FUNCTION MENU



FIG. 19: Pressure Alarm

5. Vacuum Alarm

This function allows the user to set a vacuum value threshold (as well as a corresponding percentage tolerance) before the machine can be operated. A visual and audible alarm will trigger if the vacuum is not within tolerance.



FIG. 20: Vacuum Alarm

FUNCTION MENU









1. There are three (3) parameters required for this function: MODE, Vacuum and Tolerance. Press the  key to scroll through these parameters. See FIG. 20.
2. Use the   keys to turn the Vacuum Alarm MODE On or Off. See FIG. 20.
3. Use the   keys to set the required Vacuum. Press and hold the  key to save the current vacuum setting. See FIG. 20.
4. Use the   keys to set the required Tolerance.
5. A letter "V" will show on the main screen when this function is turned ON. See FIG. 21.



FIG. 21: Tolerance



6. Whenever the vacuum value is outside of its tolerance, the letter "V" on the display will start blinking, and the  key indicator light will turn ON. See FIG. 22. Pressing the  button or stepping on the foot pedal at this point will trigger an alarm.



FIG. 22: Vacuum Alarm

7. Press the  key to clear the alarm screen. Check the vacuum setting and adjust as needed.

FUNCTION MENU

6. Auto Purge

This function allows the user to set an automatic dispense time in pre-defined intervals whenever the unit is idle. This functionality is particularly useful for sensitive (moisture, temperature, light, etc.) or multi-component materials which have strict pot-life or working life dispensing requirements. This prevents premature curing of material along the fluid lines or at the tip.



FIG. 23: Auto Purge











1. There are three (3) parameters required for this function: MODE, Delay Time and Dispense Time. Press the  key to scroll through these parameters.
2. Use the   keys to turn the Auto Purge MODE On or Off.
3. Use the   keys to set the Delay Time value. Press the  key again to choose which decimal place to edit, including the position of the decimal point. Press and hold the  key to save.
4. Use the   keys to set the Dispense Time value. Press the  key again to choose which decimal place to edit, including the position of the decimal point. Press and hold the  key to save.
5. A letter "A" will show on the main screen when this function is turned ON.



FIG. 24: Dispense Time





FUNCTION MENU

7. Power Switch

This function allows for the DC100 to be turned on by supplying power to the unit instead of pushing the power button on the unit. This can be helpful when the DC100 is being used as part of a larger system that has a main power switch, the unit can now start up and be ready for use when the main power is turned on to the system.



FIG. 25: Power Switch

1. When you are at the Power Switch mode press the  key to enter the settings page for the Power Switch function.
2. Use the   keys to turn the Power Switch Mode On or Off.
3. After selecting your mode press the  key to store and exit the function.

8. Dispense Count

This function displays the total number of completed cycles made by the machine. Every dispensing signal from all modes (except for shots made under Teach mode) is accumulated to the Dispense Count counter. Auto Purge and incomplete timed shots however, are not recorded. The counter is resettable.



FIG. 26: Dispense Count

1. When you are at the Power Switch mode, press the  key to enter the settings page for the Power Switch function.

FUNCTION MENU

9. Dispense Time

This function displays the total number of minutes of dispensing made by the machine. Every dispensing time from all modes is accumulated to the Dispense Time timer regardless of whether the full timed shot was completed.

The timer is resettable.



FIG. 27: Dispense Time

1.

Press and hold the  key to reset the Dispense Count counter.

10. Used Time

This function displays the cumulative lifetime hours that the machine is being used. The timer starts counting as soon as the unit is turned ON.

The timer is **NOT** resettable.



FIG. 28: Cumulative Lifetime Hours

CALIBRATION

The dispenser controller unit offers a calibration feature to precisely calibrate the pressure and vacuum regulators.

Instructions:

Under PURGE, TIMED or INT modes, press the  key until the screen displays the current pressure or vacuum setting.

Press and hold the  simultaneously for 2 seconds to enter the calibration menu.



FIG. 29: Calibration

CALIBRATION

Pressure Calibration

This feature allows the user to calibrate the pressure regulator. There are two calibration points available: one at 0psi, and the other at 70psi. There is also a default calibration setting which was the set point when the dispenser is pre-calibrated at the factory.



FIG. 30: Pressure Calibration



- | | |
|-----------|--|
| 1. | <p>There are three (3) calibration options for this feature: <u>In 0psi</u>, <u>In 70psi</u>, and <u>Rst Pres Value</u>.</p> <ul style="list-style-type: none"> ○ <u>In 0psi</u> means calibrating the machine at 0psi. ○ <u>In 70psi</u> means calibrating the machine at 70psi ○ <u>Rst Pres Value</u> means loading the original calibration parameters. <p>Press the  key to scroll through these options.</p> |
| 2. | <p>Attach a pressure gauge to the air outlet of the dispenser. Activate the dispenser and adjust the pressure regulator until the gauge reading matches the calibration point selected (i.e. if <u>In 70psi</u> is selected, set the pressure to 70psi).</p> |
| 3. | <p>Press and hold the  key to save and press the  key to exit.</p> |



FIG. 31: Calibration

CALIBRATION

Vacuum Calibration

This feature allows the user to calibrate the vacuum regulator. There are two calibration points available: one at 0psi, and the other at 7psi. There is also a default calibration setting which was the set point when the dispenser is pre-calibrated at the factory.



FIG. 32: Vacuum Calibration

1. There are three (3) calibration options for this feature: In 0psi, In 7psi, and Rst Vac Value.
- In 0psi means calibrating the machine at 0psi.
 - In 7psi means calibrating the machine at 7psi
 - Rst Vac Value means loading the original calibration parameters.

Press the  key to scroll through these options.

2. Attach a vacuum gauge to the air outlet of the dispenser. Activate the dispenser and adjust the vacuum regulator until the gauge reading matches the calibration point selected (i.e. if In 7psi is selected, set the vacuum to 7psi).



3. Press and hold the  key to save and press the  key to exit.



FIG. 33: Calibration

EXTERNAL CONTROL

I/O Connections

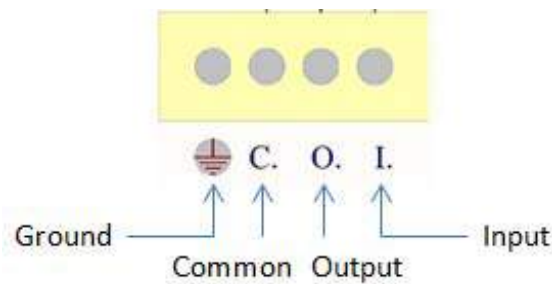
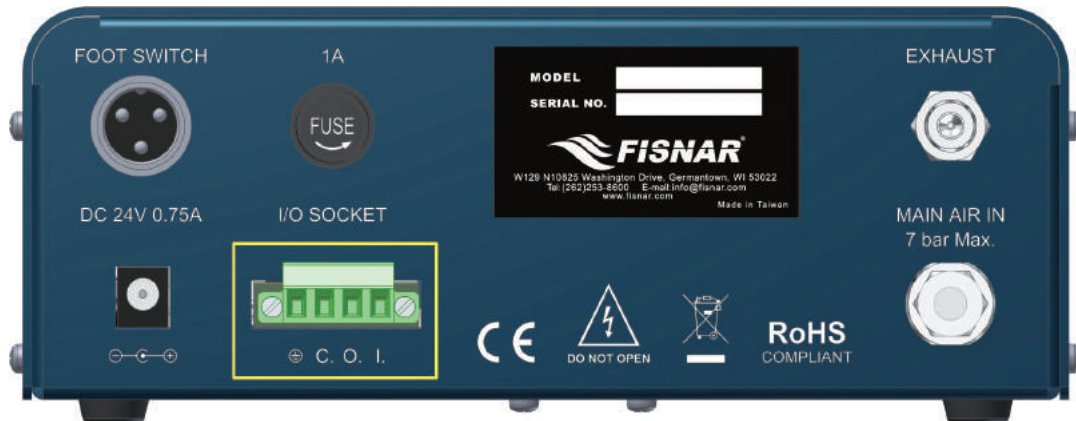

Input	A contact closure between the Input (I) and Common (C) pins will trigger a dispense signal.
Output	Activating the DC100 will close the contact between the Output (O) and Common (C) pins. If an alarm is triggered the DC100 will close the contact between the Output (O) and Common (C) pins.

EXTERNAL CONTROL

I/O Schematic

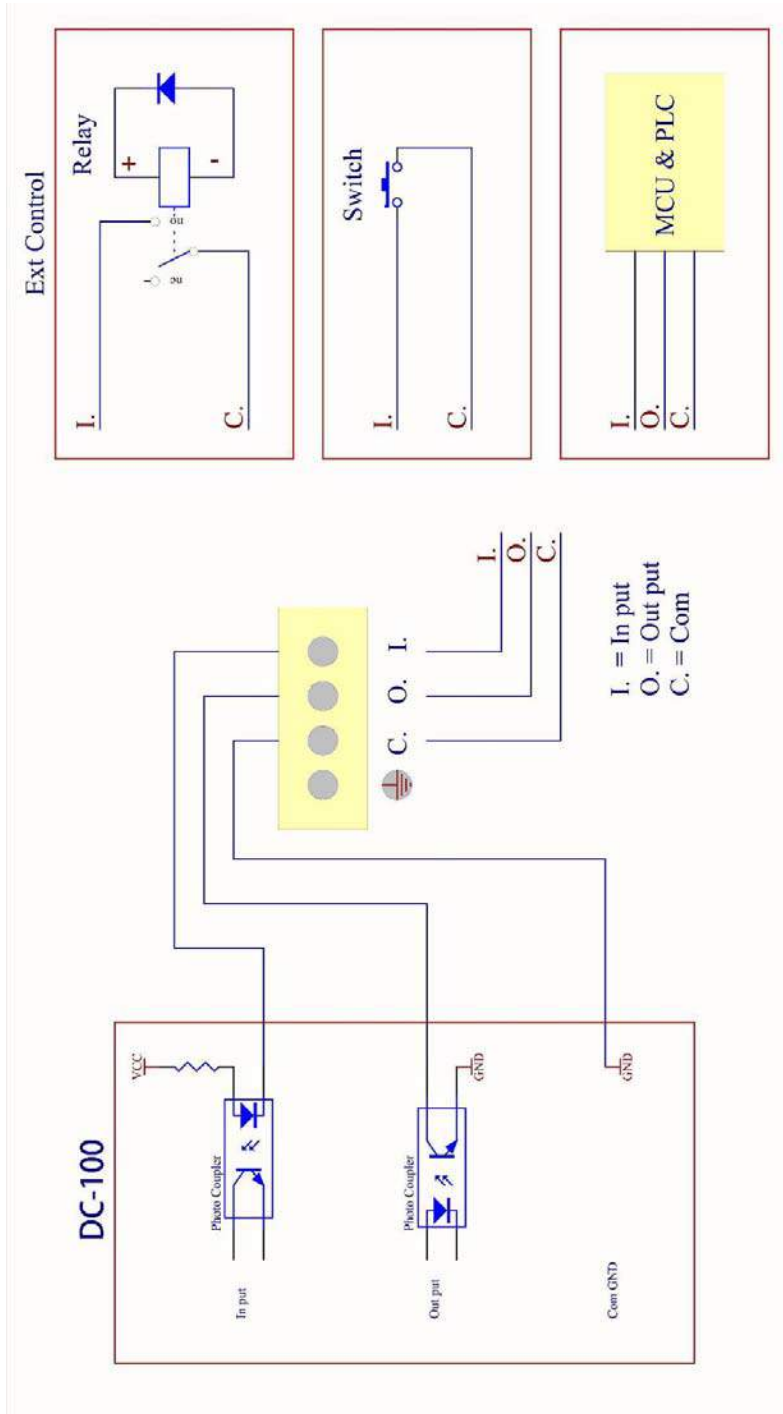

FIG. 34: I/O Schematic

EXTERNAL CONTROL

Multiple Dispensers

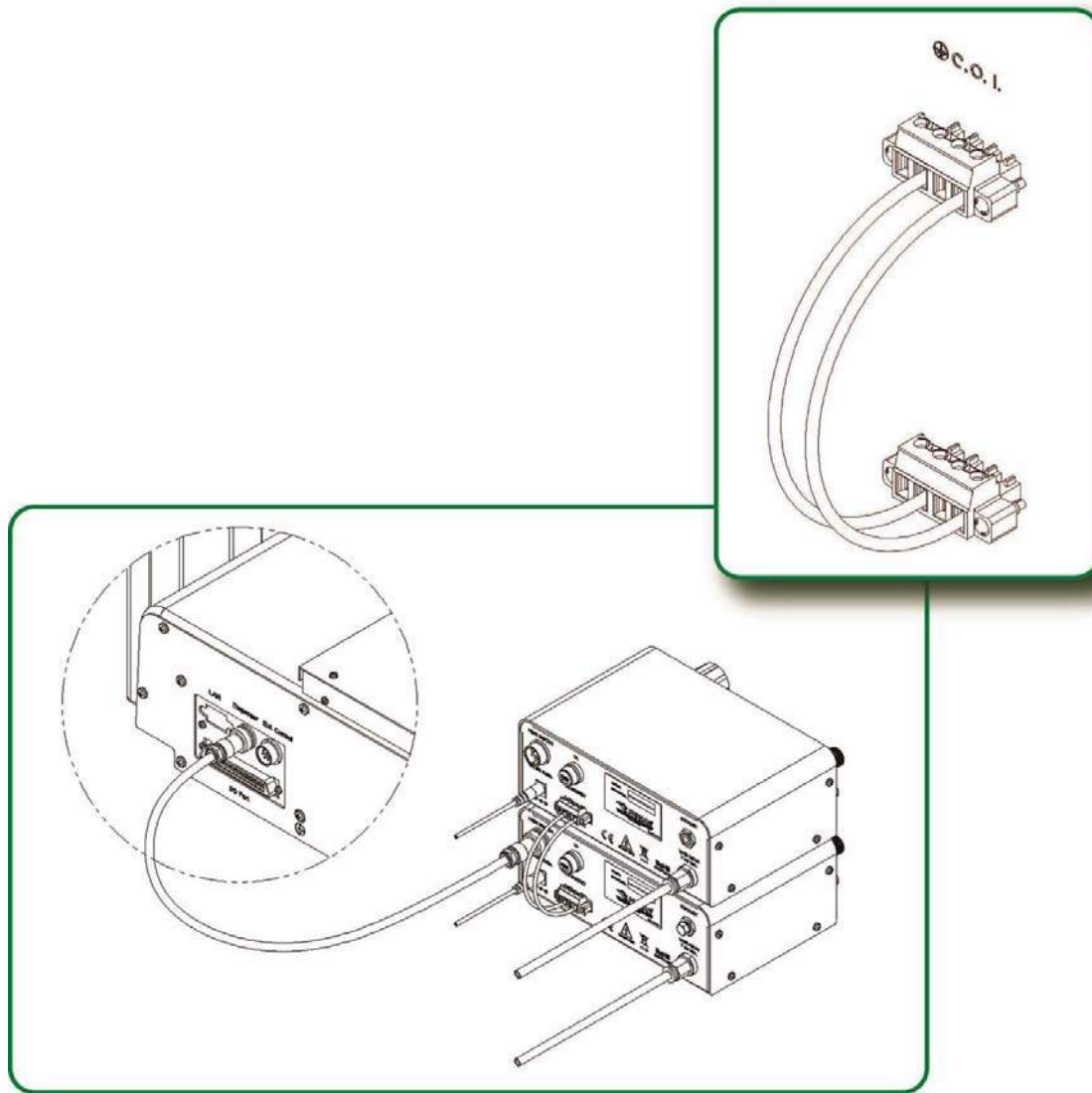

FIG. 35: Multiple Dispensers

A single input signal can activate multiple dispensers. The Input (I) and Common (C) pins must be wired in parallel for all dispensers required to actuate simultaneously.

Notes

CE Conformity checked by: Certification Experts Europe, Nieuwstad 100, 1381 CE Weesp, The Netherlands
Tel: +31 294 48 33 35, Fax: +31 294 41 46



W129 N10825 Washington Drive, Germantown, WI 53022 Telephone: (262)253-8600