



ENGINEERED
DISPENSING
SOLUTIONS



FISNAR[®]

 **FISNAR[®]**



Contents

Dispensing Consumables



Dispensing Consumables Overview	1	Dispense Tips & Nozzles	8-13
Syringe Barrels, Pistons, Tip & End Caps	2, 3	Bottles & Flow-Seal Pens	14, 15
Barrel Adapters, Dispensers & Sample Kits	4, 5	Cartridges & Accessories	16-21
Manual Syringes, Plungers & Dispensing Bottles	6, 7	Cartridges Dispensers & Barrel Loaders	22, 23

Liquid Dispensers



Liquid Dispensers Overview	25	Foot Pedal Dispenser	35
Digital Dispensers	26, 27	Vacuum Pick Up Systems	36
Peristaltic Pump Dispenser	28, 29	Pinch Tube Pens	37
Handheld Dispensers	30-32	Gravity Fed Bottle	37
Dual Cartridge Dispenser	33, 34		

Dispensing Valves



Dispensing Valves Overview	39, 40	High Pressure	50
Pinch Tube	41, 42	Auger	51
Diaphragm	43	Positive Displacement	52
Needle	44	Mini Spool	53
Cartridge	45	Workbench Stands	54
Spray	46, 47	Valve Controllers	55-58
Poppet	48, 49		

Reservoirs & Pumps



Reservoirs & Pumps Overview	59	Pump Systems	66, 67
Reservoir Tanks	60-62	Fittings	68-71
Clear View Pressure Chamber	63	Tubing	72
Extruder Systems	64, 65	Manifolds, Mufflers & Filters	73

Robotics

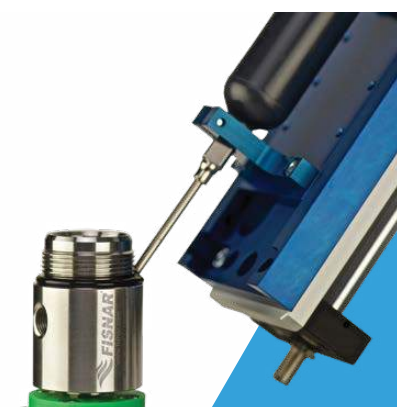

Robotics Overview	75	Vision Systems	91
Gantry	76, 87	Robot Diagram & Upgrades	92, 93
Benchtop	77-85	Robot Holder Assemblies	94-101
Cantilever	86	Accessories	102, 103
Selective Compliance Assembly Robot Arm (SCARA)	88	Valve/Bracket/Holder & Stand Chart	104
Rotary Table	89	Robot Kits	105-109
Tip Alignment & Height Sensor	90		



Dispensing Consumables

Premium Dispense Management



QuantX™ is a fluid management system defined by its carefully designed and precisely engineered components.

Together these components provide a superior industrial dispensing experience, resulting in reduced waste, greater accuracy, and improved yields.

QuantX™ Syringe Barrels

QuantX™ syringe barrels feature a highly accurate manufacturing process that combines minimal resistance and parallel uniformity over the length of the syringe barrel.

Manufactured from premium grade silicone-free polypropylene, these syringe barrels are available in clear for non-UV materials, amber for UV protection (240-255nm), and opaque black for maximum light protection.

All barrels are designed with a round base to fit QuantX™ barrel adapter assemblies.



DISPENSING CONSUMABLES

Size	Clear	Amber	Black	I.D. (inch)	O.D. (inch)	Length (inch)
3cc	8001001	8001040	8001045	0.379	0.453	2.941
5cc	8001002	8001041	8001046	0.500	0.567	2.756
10cc	8001003	8001042	8001047	0.622	0.733	3.567
30cc	8001004	8001043	8001048	0.891	1.000	4.634
55cc	8001005	8001044	8001049	0.891	1.020	6.898

QuantX™ Syringe Barrels & Piston Sets

Syringe barrel and piston sets ensure that matched QuantX™ components are always used in the QuantX™ fluid management system providing optimum dispensing performance.

Size	Clear	Amber	Black
3cc	8001058	8001063	8001068
5cc	8001059	8001064	8001069
10cc	8001060	8001065	8001070
30cc	8001061	8001066	8001071
55cc	8001062	8001067	8001072



QuantX™ Pistons

Evenpress™ Piston Selection

Smooth flow green pistons prevent air entrapment and material waste by wiping the syringe barrel wall clean.

Flat wall blue pistons are recommended for reducing potential stringing and bouncing when dispensing high-viscosity fluids.

Low viscosity orange pistons are used for preventing dripping of watery fluids and accidental back-flow into the dispenser.

Soft black rubber pistons are used to prevent tunneling in high-viscosity fluid materials.



Size	Smooth Flow Green	Flat Wall Blue	Low Viscosity Orange	Unlubricated Black	Lubricated Black
3cc	8001006	8001010	8001506	8001510	8001514
5cc	8001007	8001011	8001507	8001511	8001515
10cc	8001008	8001012	8001508	8001512	8001516
30/55cc	8001009	8001013	8001509	8001513	8001517

QuantX™ Syringe Barrel Tip Caps

Tip caps provide an air-tight seal allowing storage of pre-filled syringe barrels.

Item Number	Type
8001038	Flat
8001039	Pointed



QuantX™ Syringe Barrel End Caps

End caps feature a push and twist design to ensure an air tight seal and secure the neck opening of the syringe barrel when in storage.



Size	Item Number
3cc	8001034
5cc	8001035
10cc	8001036
30/55cc	8001037

QuantX™ Syringe Barrel Adapter Assemblies

QuantX™ syringe barrel adapter assemblies provide a convenient quick connect to the controller from the syringe barrel. Fitted with Buna Nitrile O-rings.

They are available with two hose lengths and optional micron filter-trap to prevent entry of fluids and fumes into the controller.



Size	3ft (0.9m)	6ft (1.8m)	3ft with Filter (0.9m)
3cc	8001014	8001018	8001050
5cc	8001015	8001019	8001051
10cc	8001016	8001020	8001052
30/55cc	8001017	8001021	8001053

DISPENSING CONSUMABLES

QuantX™ Adapter Head with O-Ring

Size	Item Number
3cc	8001026
5cc	8001027
10cc	8001028
30/55cc	8001029



QuantX™ Adapter Heads Replacement O-Rings

Size	Buna N	Viton®
3cc	8001030	8001054
5cc	8001031	8001055
10cc	8001032	8001056
30/55cc	8001033	8001057



QuantX™ Syringe Barrel Kits

Syringe barrel kits are available for validation of different size and color variations for both UV and non-UV materials.

The QK-CSK pictured includes all syringe barrels, adapter assemblies, and the most popular pistons and dispense tips.



Size	Clear	UV
3/5/10cc	QK-3510	QK-3510UV
30/55cc	QK-3055	QK-3055UV
Complete Kit	QK-CSK	

QuantX™ Tip Selection Kit

A selection of the most commonly used dispense tips (blunt end, tapered, PTFE lined, and flexible) in varying gauge sizes.



Item Number	Description
QK-NSK	Tip Selection Kit

QuantX™ Dispensing Selection Kit

The DCK800 selection kit includes a selection of dispense tips, syringe barrels, pistons, and caps. A supply reference chart is also included.

Item Number	Description
DCK800	Dispensing Selection Kit



Manual Syringes

Disposable, graduated, polypropylene, luer lock-style syringes fitted with a lubricated rubber piston and plunger for manually dispensing a variety of fluids.

Size	Manual Syringe
3cc	8401006
5cc	8401007
10cc	8401008
35cc	8401009
60cc	8401012



QuantX™ Manual Syringe Plunger

An ergonomic and lightweight, reusable hand plunger for manually dispensing a variety of fluids.

Compatible for use with all QuantX™ syringe barrels, green smooth-flow, and black rubber pistons.



Size	Manual Plunger
3cc	8401014
5cc	8401015
10cc	8401016
30cc	8401018



JD927 Manual Syringe Barrel Dispensers

Lightweight and comfortable dispensers with an easy twist-on barrel mounted design. Each squeeze of the trigger advances the plunger by 0.24" (6mm) dispensing a precise amount of material every time.

These dispensers are capable of dispensing most fluids by using a finger-tip control and push button plunger release.

Size	Item Number
10cc	JD927-10
30/55cc	JD927-3055



Manual Dispensing Bottles



A selection of low-density squeeze bottles for manual dispensing a variety of fluids. Available in both oval and round bottle types. Caps and bottles are interchangeable based on application requirements. Caps come in different thread sizes and correspond to matching threads on bottles. *Bottles and caps sold separately.*



Size	Thread	Oval Bottle	Luer Lock Cap	Slip Lock Cap
1/2oz	15mm	EAOB0515	EALLC15	EASC15
3/4oz	15mm	EAOB07515	EALLC15	EASC15
2oz	18mm	EAOB218	EALLC18	EASC18
4oz	20mm	EAOB420	EALLC20	EASC20
8oz	24mm	EAOB824	EALLC24	EASC24



Size	Thread	Round Bottle	Luer Lock Cap	Slip Lock Cap
1/2oz	15mm	EARB0515	EALLC15	EASC15
1oz	18mm	EARB118	EALLC18	EASC18
2oz	18mm	EARB218	EALLC18	EASC18
4oz	24mm	EARB424	EALLC24	EASC24
8oz	24mm	EARB824	EALLC24	EASC24
16oz	28mm	EARB1628	-	EASC28

QuantX™ Blunt End Dispense Tips

A full selection of UV epoxy-sealed dispense tips manufactured with polypropylene hubs and stainless steel cannulas. A double helix luer lock design and polished burr-free finish ensure precision fluid dispensing. For dispensing low to high viscosity fluids in general purpose dispense applications.

DISPENSING CONSUMABLES



Color	Gauge	I.D. (inch)	I.D. (mm)	1/4" (6.35mm)	1/2" (12.7mm)	1" (25.4mm)	1 1/2" (38.1mm)	1/2" 45°	1/2" 90°
Olive	14	0.063	1.60	8001115	8001084	8001095	8001105	8001156	8001166
Amber	15	0.054	1.37	8001073	8001085	8001096	8001106	8001157	8001167
Black	16	0.047	1.20	8001074	8001086	8006031	8001495	8001802	
Green	18	0.033	0.84	8001075	8001087	8001097	8001107	8001158	8001168
Pink	20	0.024	0.60	8001076	8001088	8001098	8001108	8001159	8001169
Purple	21	0.020	0.51	8001077	8001089	8001099	8001109	8001160	8001170
Blue	22	0.016	0.41	8001078	8001090	8001100	8001110	8001161	8001171
Orange	23	0.013	0.33	8001079	8001091	8001101	8001111	8001162	8001172
Red	25	0.010	0.25	8001080	8001092	8001102	8001112	8001163	8001173
Beige	26	0.009	0.23	-	8001463	-	-	-	-
Clear	27	0.008	0.20	8001081	8001093	8001103	8001113	8001164	8001174
Lavender	30	0.006	0.15	8001082	8001094	8001104	8001114	8001165	8001175
Yellow	32	0.004	0.10	8001083	8001117	-	-	-	-
Lt. Green	33	0.003	0.08	8001116	-	-	-	-	-

QuantX™ Tapered Dispense Tips

Tapered smooth flow dispensing tips are designed to reduce back pressure of high-viscosity fluids resulting in an increased fluid flow rate. A uniform polypropylene luer lock design with a flash-free outlet ensures consistent fluid dispensing.

Double tapered tips feature a unique fluid outlet design to reduce fluid wicking and dripping on low-viscosity materials.

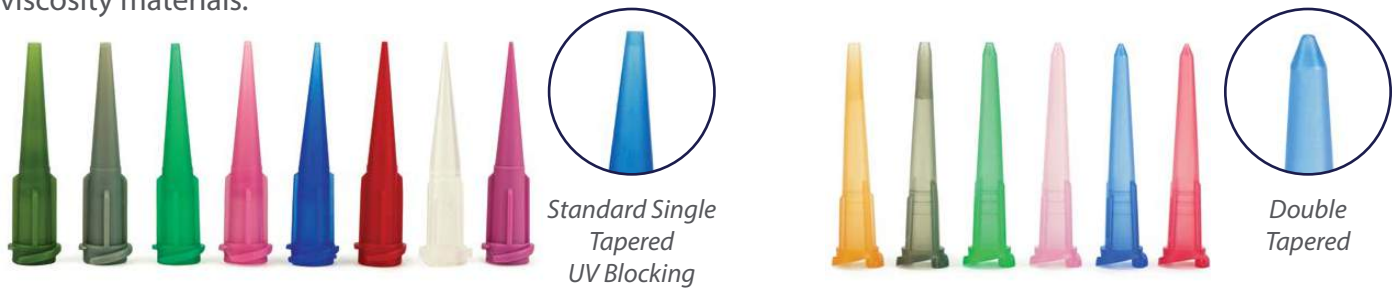

Color	Gauge	I.D. (inch)	I.D. (mm)	Length (inch/mm)	Single Tapered	Double Tapered
Olive	14	0.063	1.60	1.25/32	8001269	-
Orange	14	0.063	1.60	1.25/32	-	8001263
Gray	16	0.047	1.20	1.25/32	8001270	8001264
Green	18	0.033	0.84	1.25/32	8001271	8001265
Pink	20	0.024	0.60	1.25/32	8001272	8001266
Blue	22	0.016	0.41	1.25/32	8001273	8001267
Red	24	0.014	0.37	1.25/32	-	8001268
Red	25	0.010	0.25	1.25/32	8001274	-
Clear	27	0.008	0.20	1.25/32	8001277	-
Lavender	30	0.006	0.15	1.25/32	8001276	-

QuantX™ UV & Light Block Dispense Tips

Used for dispensing medium to high viscosity fluids while blocking all UV and ambient light-emitting rays and wavelengths.



Color	Gauge	I.D. (inch)	I.D. (mm)	Length (inch/mm)	UV & Light Block
Black	14	0.063	1.60	1.25/32	8001278
Black	16	0.047	1.20	1.25/32	8001281
Black	18	0.033	0.84	1.25/32	8001282
Black	20	0.024	0.60	1.25/32	8001283
Black	22	0.016	0.41	1.25/32	8001284
Black	25	0.010	0.25	1.25/32	8001279
Black	27	0.008	0.20	1.25/32	8001275

QuantX™ Flexible Dispense Tips

Polypropylene flexible dispense tips designed to be used in hard-to-reach areas and to prevent scratching or damage to fragile dispense surfaces.



Color	Gauge	I.D. (inch)	I.D. (mm)	1/2" (12.7mm)	1 1/2" (38.1mm)
Olive	14	0.063	1.60	8001285	8001291
Amber	15	0.054	1.37	8001286	8001292
Green	18	0.033	0.84	8001287	8001293
Pink	20	0.024	0.60	8001288	8001294
Blue	22	0.016	0.41	8001289	8001295
Red	25	0.010	0.25	8001290	8001296

QuantX™ PTFE-Lined Dispense Tips

Stainless steel cannulas with an internal PTFE lining, projecting approximately 1/8" (3.18mm) from the cannula. Ideal for dispensing very low-viscosity fluids, solvents, and cyanoacrylates.

Color	I.D. (inch)	I.D. (mm)	1/2" (12.7mm)	1" (25.4mm)
Gray	0.023	0.60	8001252	8001254
Pink	0.011	0.28	8001253	8001255



QuantX™ Micron-S Precision Dispense Tips

Precision conical tips offer high accuracy, micro-dot dispensing due to their low-resistance, fluid flow design. These precision-machined tips have been specifically designed to improve flow rates and overall performance.

The thin rigid wall design enhances accuracy and definition of dots, lines, or special patterns while reducing fluid stringing or tailing tendencies. PTFE-coated versions reduce fluid wicking and dripping, and are compatible with anaerobic fluids.



Standard Bore



Micron Bore

Color	Gauge	I.D. (inch)	I.D. (mm)	O.D. (inch)	O.D. (mm)	Standard Bore	Micron Bore	PTFE Coated
Pink	18	0.041	1.041	0.049	1.254	5901001	-	5901012
Tan	19	0.034	0.864	0.042	1.067	5901002	-	5901013
Green	20	0.027	0.686	0.035	0.889	5901003	-	5901014
Lt. Blue	21	0.024	0.609	0.032	0.813	5901004	-	5901015
Purple	23	0.022	0.564	0.025	0.635	5901005	-	5901016
White	25	0.017	0.437	0.020	0.508	5901006	-	-
Red	27	0.013	0.335	0.016	0.406	5901007	-	-
Black	30	0.009	0.223	0.012	0.305	5901008	-	-
Blue	150um	0.006	0.16	0.010	0.24	-	5901009	-
Orange	100um	0.004	0.11	0.008	0.20	-	5901010	-
Yellow	50um	0.002	0.06	0.006	0.16	-	5901011	-

QuantX™ Micron Selection Kit

Micron selection kit contains each of the standard bore nozzle tip sizes for testing and validation purposes.

Item Number

QK-MSK



Stainless Steel Dispense Tips

Stainless steel dispensing tips are available in single or double cannula designs. Each stainless steel tip consists of a precision stainless steel cannula and hub designed to fit standard luer lock connections.

This range of tips can be sterilized by an autoclave process for applications requiring sterile equipment.



Custom lengths and diameters are available upon request.

DISPENSING CONSUMABLES

Single Cannula

Gauge	I.D. (inch)	I.D. (mm)	Length (inch/mm)	Item Number
13	0.071	1.80	0.5/13	813050SS1
14	0.063	1.60	0.5/13	814050SS1
15	0.054	1.37	0.5/13	815050SS1
16	0.047	1.20	0.5/13	816050SS1
17	0.042	1.07	0.5/13	817050SS1
18	0.033	0.84	0.5/13	818050SS1
19	0.027	0.69	0.5/13	819050SS1
20	0.024	0.60	0.5/13	820050SS1
21	0.020	0.51	0.5/13	821050SS1
22	0.016	0.41	0.5/13	822050SS1
23	0.013	0.33	0.5/13	823050SS1
24	0.012	0.30	0.5/13	824050SS1
25	0.010	0.25	0.5/13	825050SS1
26	0.009	0.23	0.5/13	826050SS1
27	0.008	0.20	0.5/13	827050SS1

Double Cannula

Gauge	I.D. (inch)	I.D. (mm)	Length (inch/mm)	Item Number
16	0.047	1.20	0.79/20	816050SS2
17	0.042	1.07	0.79/20	817050SS2
18	0.033	0.84	0.79/20	818050SS2
19	0.027	0.69	0.79/20	819050SS2
20	0.024	0.60	0.79/20	820050SS2
21	0.020	0.51	0.79/20	821050SS2
22	0.016	0.41	0.79/20	822050SS2
23	0.013	0.33	0.79/20	823050SS2
24	0.012	0.30	0.79/20	824050SS2
25	0.010	0.25	0.79/20	825050SS2
26	0.009	0.23	0.79/20	826050SS2
27	0.008	0.20	0.79/20	827050SS2

Stainless Steel Tip Selection Kit

Stainless steel single tip selection kit contains one of each of the sizes below for testing and validation purposes.

13, 14, 15, 18, 20, 21, 22, 23, 25, 26, 27, 30 gauges.

Item Number

QK-SSTK



Brush Tips

Brush tips are designed for spreading, brushing, and applying greases, adhesives, and fluid materials. Tips contain either sable or nylon bristles and come in three styles: Type A, Type B, and Economy, depending on application requirements.

Type A



Gauge	Brush Diameter	Style	Item Number
16	10mm	Flat Sable	5701265
18	10mm	Flat Sable	5701266
22	10mm	Flat Sable	5701267
16	5mm	Round Nylon	5701268
18	5mm	Round Nylon	5701269
22	5mm	Round Nylon	5701270

Type B



Gauge	Brush Diameter	Style	Item Number
21	2mm	Round Nylon	5702102
27	2mm	Round Nylon	5702702
14	5mm	Round Nylon	5701405
21	5mm	Round Nylon	5702105
27	5mm	Round Nylon	5702705
14	10mm	Flat Nylon	5701410
21	10mm	Flat Nylon	5702110
27	10mm	Flat Nylon	5702710

Economy



Gauge	Brush Diameter	Style	Item Number
15	3mm	Round Soft	8001309
15	3mm	Round Stiff	8001310

Brush Tip Selection Kit

Brush tip selection kits are available in two different options for testing and validation purposes. QK-BTK-A contains 1 of each Type A style brush tips. QK-BTK-B contains 1 of each Type B style brush tips.

Type	Item Number
A	QK-BTK-A
B	QK-BTK-B



Dipit™ Bottles

Dipit™ Touch-Pump bottles provide a clean method of delivery by conveniently presenting a small reservoir of solvent, cleaner, or alcohol.

Fluid-ready for dipping a brush or wipe for assembly, production, or laboratory purposes.

Ideal for PCB soldering operations and clean rooms. Prevents wasteful evaporation and contamination. Stainless steel lid and pump components.



DISPENSING CONSUMABLES

Item Number	Description
5606026	4oz touch pump bottle
5606027	8oz touch pump bottle

Dipit™ Brushes

Item Number	Description
5701272	Dipit™ brush delrin 1/4" nylon soft
5701273	Dipit™ brush zinc/steel 3/8" bristle
5701274	Dipit™ brush dual head 3/16" - 1/4" hard



Flow-Seal Pens & Bottles

Flow-seal pens and bottles are designed to channel controlled amounts of no-clean flux, solvents, lubricants, masking, water-based liquids, and more.

Flow-seal products prevent evaporation of material and conform to current regulations for controlling substances capable of evaporation hazards.

**All pens and bottles come supplied with chisel nib 381-8425-AC.*



Features

- Priming is achieved by depressing the tip while the pen is vertical
- A unique dispensing valve prevents flooding and soaking by releasing material in controlled amounts to the nib
- Cap valve allows for easy removal of tips when cleaning or replacing
- Flow-seal pens are cost efficient as product is only delivered when required

Item Number	Description	Size	Material
FV-0100	Flow-Seal Pen	0.34oz/ 10ml	HDPE (Clear)
FV-0200	Flow-Seal Pen (ESD Safe)	0.34oz/ 10ml	Aluminum
FV-0300	Flow-Seal Bottle	2oz/ 59.14ml	HDPE (Clear)
FV-0400	Flow-Seal Bottle (ESD Safe)	2oz/ 59.14ml	Aluminum
FV-0500	Flow-Seal Bottle	4oz/ 118.21ml	HDPE (Clear)
FV-0600	Flow-Seal Jumbo Pen	1.35oz/ 40ml	HDPE (Black)

Item Number	Description	Material
381-8425-AC	Chisel Nib	Acrylic
381-8425-AB	Bullet Nib	Acrylic
381-8425-AP	Pointed Nib	Acrylic
381-8425-PC	Chisel Nib	Polyester
381-8425-PB	Bullet Nib	Polyester
381-600-PB	Blunt Tip (FV-0600 only)	Polyester

Cartridges

High-quality, disposable cartridges provide a clean and efficient method to meet all types of production requirements. For use in a wide range of applications including pre-mixed and frozen materials, as well as prepackaged products.

Cartridges available in a variety of different sizes and capacities. Can be used with manual, handheld, or pneumatic air-powered equipment.

All cartridges are molded in either low or high-density polyethylene. Black cartridges are designed for use with UV and light curing fluids.



DISPENSING CONSUMABLES

Item Number	Description	Length (inch/mm)	Diameter (inch/mm)	Capacity (oz/ml)
EA25C-LD	Natural LDPE	4.00/101.60	1.59/40.40	2.5/74
EA60C-LD	Natural LDPE	7.11/180.60	1.59/40.40	6/177
EA80C-LD	Natural LDPE	8.92/226.60	1.59/40.40	8/237
EA120C-LD	Natural LDPE	12.34/313.40	1.59/40.40	12/355
EA110C-LD	Natural LDPE	8.99/228.30	1.85/47.00	12.8/310
EA25C-HD	Natural HDPE	4.00/101.60	1.59/40.40	2.5/74
EA60C-HD	Natural HDPE	7.11/180.60	1.59/40.40	6/177
EA80C-HD	Natural HDPE	8.92/226.50	1.59/40.40	8/237
EA120C-HD	Natural HDPE	12.34/313.40	1.59/40.40	12/355
EA110C-HD	Natural HDPE	8.99/228.30	1.85/47.00	12.8/310
EA200C-HD	Natural HDPE	10.03/254.80	2.57/65.30	20/591
EA25C-HD-BK	Black HDPE	4.00/101.60	1.59/40.40	2.5/74
EA60C-HD-BK	Black HDPE	7.11/180.60	1.59/40.40	6/177
EA80C-HD-BK	Black HDPE	8.92/226.50	1.59/40.40	8/237
EA120C-HD-BK	Black HDPE	12.34/313.40	1.56/40.40	12/355
EA110C-HD-BK	Black HDPE	8.99/228.30	1.85/47.00	12.8/310
EA200C-HD-BK	Black HDPE	10.03/254.80	2.57/65.30	20/590

Dispensing Nozzles

Dispensing nozzles are precision molded from polyethylene and have 1/4" NPT male threads to fit cartridges, valves, and other compatible equipment.

Standard Nozzles

Standard nozzles are designed to be used in applications requiring basic dispensing of beads and dots.

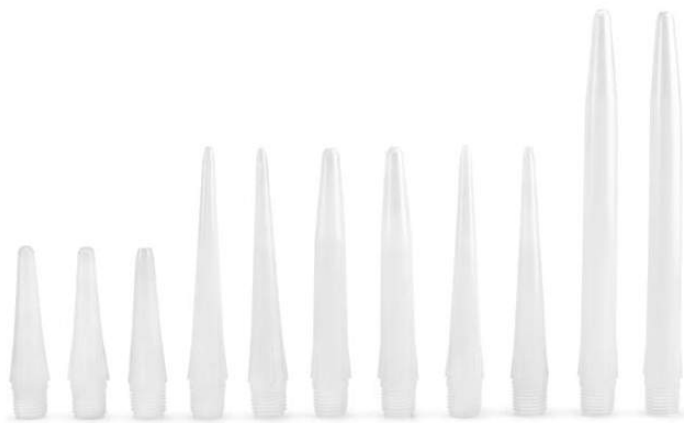

Item Number	Length (inch)	Diameter (inch)	Material
EA2160-HD	2	1/16	HDPE
EA2180-LD	2	1/8	LDPE
EA2180-HD	2	1/8	HDPE
EA4160-HD	4	1/16	HDPE
EA4160-LD	4	1/16	LDPE
EA4180-LD	4	1/8	LDPE
EA4320-HD	4	1/32	HDPE
EA4320-LD	4	1/32	LDPE
EA4900-LD	4	3/32	LDPE
EA6160-LD	6	1/16	LDPE
EA6180-LD	6	1/8	LDPE

Specialty Nozzles

Specialty nozzles are designed in a variety of styles for custom applications that require spreading, brushing, step filling, and more.



Item Number	Length (inch)	Dimension (inch)	Material	Nozzle Style
EA1050	4	1/2 x 1/16	HDPE	Spreader
EA1050-45	4	1/2 x 1/16	HDPE	45° Spreader
EA1075	4.5	3/4 x 1/8	HDPE	Spreader
EA1100	4.5	1 x 1/8	HDPE	Spreader
EA1175	4	1 3/4 x 1/8	HDPE	Spreader
EA3106	4	3/8 x 1/8	HDPE	Fillet Right Step
EA3206	4	3/8 x 1/8	HDPE	Fillet Left Step

Cartridge Plungers

The use of plungers ensures even pressure is applied on the fluid, while also preventing tunnelling of air to achieve controlled and repeatable dispense results. The plungers wipe clean design maximizes fluid usage from within the cartridge. Plungers are available in low or high-density polyethylene and come in a variety of sizes to fit compatible cartridges.

Item Number	Color	Description
EA1WP-LD-NT	Natural	2.5, 6, 8, 12oz - Wiper LDPE
EA1WP-LD-BL	Blue	2.5, 6, 8, 12oz - Wiper LDPE
EA1WP-LD-BK	Black	2.5, 6, 8, 12oz - UV Blocking Wiper LDPE
EA110WP-LD-NT	Natural	1/10th gallon - Wiper LDPE
EA200WP-LD-NT	Natural	20oz - Wiper LDPE
EA200WP-HD-NT	Natural	20oz - Wiper HDPE



Cartridge Caps

End and tip caps are designed to seal out air for proper storage and handling purposes. Available in snap on, push on, and threaded styles.

Item Number	Description
EA2C	2.5, 6, 8, 12oz - End Cap LDPE
EA110CP	1/10th gallon - End Cap LDPE
EA6C	20oz - End Cap LDPE
EA3P	Threaded Tri-Seal Cap PE
EA4P	Threaded Tip Cap PE
EA5P	Snap On Tri-Seal Tip Cap PE
EA9X	Snap On Tip Cap PE



Cartridge Tip Adapters

Allows for the use of QuantX™ dispense tips with luer lock hubs. 1/4" NPT tip adapters for use with cartridges and valves fitted with 1/4" NPT female threads.

Item Number	Description
5801420	Tip Adapter - Metal
5601390	Tip Adapter - Natural Polypropylene
5801449	Tip Adapter - Black Polypropylene
5801450	Tip Adapter - White Polypropylene



Metal Cartridge Retainers & Caps

Heavy duty, light-weight aluminum retainers can withstand up to 100psi (6.9bar) pressure. Cartridge retainers accommodate all corresponding cartridge sizes. *Retainer caps sold separately.*

Item Number	Description
918-030-000	74ml/2.5oz Cartridge Retainer
918-031-000	177ml/6oz Cartridge Retainer
918-034-000	237ml/8oz Cartridge Retainer
918-032-000	355ml/12oz Cartridge Retainer
5601376	Retainer Cap with Seal Ring
5601377	Retainer Cap with Regulator Guage
5601378	Sealing Ring
5601357	Connecting Hose (5ft)



Item Number	Description
101-20R	591ml/20oz Cartridge Retainer <i>*Requires 101-20A</i>
101-20A	20oz Retainer Adapter
918-000-036	Retainer Cap
110-1-10	Pistol Grip Dispenser Handle



Cartridge Retainer Stands

Item Number	Description
560535U	2.5, 6, 8, 12oz Metal Slotted Retainer Cartridge Stand
560534U	20oz Metal Retainer Cartridge Stand



1/10th Gallon Plastic Retainer & Cap

The 580091H-A is an economical retainer designed to dispense from standard caulking cartridges. Dispensing can be delivered with fine gauge luer lock tips or with larger nozzles. Dispensing pressure should not exceed 65psi (4.48 bar).

Item Number	Description
580091H-A	Plastic Cartridge Retainer Assembly (Retainer, Cap, Seals, and Hose)
580091H-CF	1/10th gallon Cap with Fittings
5601357	Connecting Hose (5ft)
560655	Rubber Seal
562027	Plastic Spacer



Nylon Cartridge Retainers & Caps

Durable, nylon molded, screw cap retainers are lightweight and can withstand up to 100psi (6.9bar) pressure. Cartridge retainers accommodate 6oz and 12oz cartridges. Compatible with Techon, Semco, and EFD-style cartridge systems.

Item Number	Description
5801380-KIT	6oz Cartridge Retainer Assembly with Hose
5801382-KIT	12oz Cartridge Retainer Assembly with Hose
5801376	Retainer Screw Cap with Fittings
5801380	6oz Cartridge Retainer Body
5801382	12oz Cartridge Retainer Body
5601357	Connecting Hose (5ft)



1/10th Gallon Metal Cartridge Retainer

The CR300 was developed with a new seal design, guaranteeing greater seal performance and durability by sealing directly onto the inside of the 'inserted' cartridge.

Fully compatible with 1/10th gallon plastic and metal caulking type cartridges (300/310ml). This high-grade anodized alloy retainer and cap ensure a safe and comfortable dispensing pressure of up to 100psi (6.9Bar).

With high performance and unique versatility, this retainer can be used as a pressurized fluid reservoir system in conjunction with a Fisnar dispense valve.

Hose and spare sealing ring included standard with CR300.

Features

- Supplied with a universal air-inlet for effortless system installation and integration
- Designed for long lasting use
- Equipped with a quick and easy screw on cap and can be attached directly to a Fisnar air-powered dispenser
- An optimized tube design reducing cartridge expansion while decreasing the risk of air ingress into the fluid
- Works efficiently with 1/10th gallon cartridge adapter nuts to convert the male thread on a standard caulking type cartridge to a conventional female 1/4" NPT thread



**560549U stand sold separately.*

Item Number	Description
CR300	Cartridge Retainer Assembly (Retainer, Cap, Seals, and Hose)
CR300-SEAL	Retainer Cap Sealing Ring
560549U	Cartridge Retainer Stand
562146	Quick Connect Hose (6ft)

Cartridge Adapter Nuts

Used for converting the male thread on a 310ml (1/10th gallon) cartridge to a 1/4" NPT female thread. 1/4" NPT nozzles, tip adapters, or fittings can be connected to allow material dispensing directly from the cartridge.

Item Number	Description
561129-SS	316 Stainless Steel
561129	White Acetal



Manual & Pneumatic Cartridge Dispensers

A range of manual and pneumatic dispensers for use with most standard and prefilled cartridges.

- FMG-60, FLG-60, FPG-60, FMG-120, FLG-120 and FPG-120 dispenser kits are compatible with Techcon, Semco, and EFD style 6oz and 12oz cartridge systems
- FMG-25T, FMG-60T, FMG-80T and FMG-120T dispenser kits are compatible with Techcon style 2.5oz, 6oz, 8oz, and 12oz cartridge systems
- FPG-300 dispenser kit is compatible with all standard plastic 1/10th gallon (300ml) caulking-style cartridge systems

Fisnar Manual Dispensers - Nylon Retainer

Item Number	Description
FMG-60	6oz Manual Dispenser Kit
FMG-120	12oz Manual Dispenser Kit



Fisnar Manual Dispensers - Metal Retainer

Item Number	Description
FMG-25T	2.5oz Manual Metal Slotted Retainer Dispenser Kit
FMG-60T	6oz Manual Metal Slotted Retainer Dispenser Kit
FMG-80T	8oz Manual Metal Slotted Retainer Dispenser Kit
FMG-120T	12oz Manual Metal Slotted Retainer Dispenser Kit



Fisnar Lever Actuated Dispensers - Nylon Retainer

Item Number	Description
FLG-60	6oz Lever Actuated Dispenser Kit
FLG-120	12oz Lever Actuated Dispenser Kit



Fisnar Pistol Grip Dispensers

Item Number	Description
FPG-60	6oz Pistol Grip Dispenser Kit (Nylon Retainer)
FPG-120	12oz Pistol Grip Dispenser Kit (Nylon Retainer)
FPG-300	300ml Pistol Grip Dispenser Kit (Metal Retainer)



Manual Barrel Loaders

The 560548U Series of manual barrel loaders will fill a barrel directly from a 6oz, 12oz, 20oz, or 300ml cartridge.

Barrel loaders are connected to an air regulator and set to a pressure suitable for the material not exceeding 65psi (4.48 bar). A manual switch on the base actuates the air supply and pressurizes the cartridge to fill the syringe barrel.

The barrel fillers' internal air relief valve allows for decompression when the trigger is released. The system can be used for timed filling when connected to a Fisnar automatic controller.

Item Number	Description
560548U-6	6oz Barrel Loader
560548U-12	12oz Barrel Loader
560548U-300	300ml Barrel Loader
560548U-20	20oz Barrel Loader

Replacement Parts

Item Number	Description
561105	1/4" NPT Elbow
TSD931-15	Syringe Filling Adapter
560710	Luer Lock Cap
560546	1/10 Gallon Nozzle Adapter
561129	1/10 Gallon Nozzle Adapter

Syringe barrel and piston sold separately.



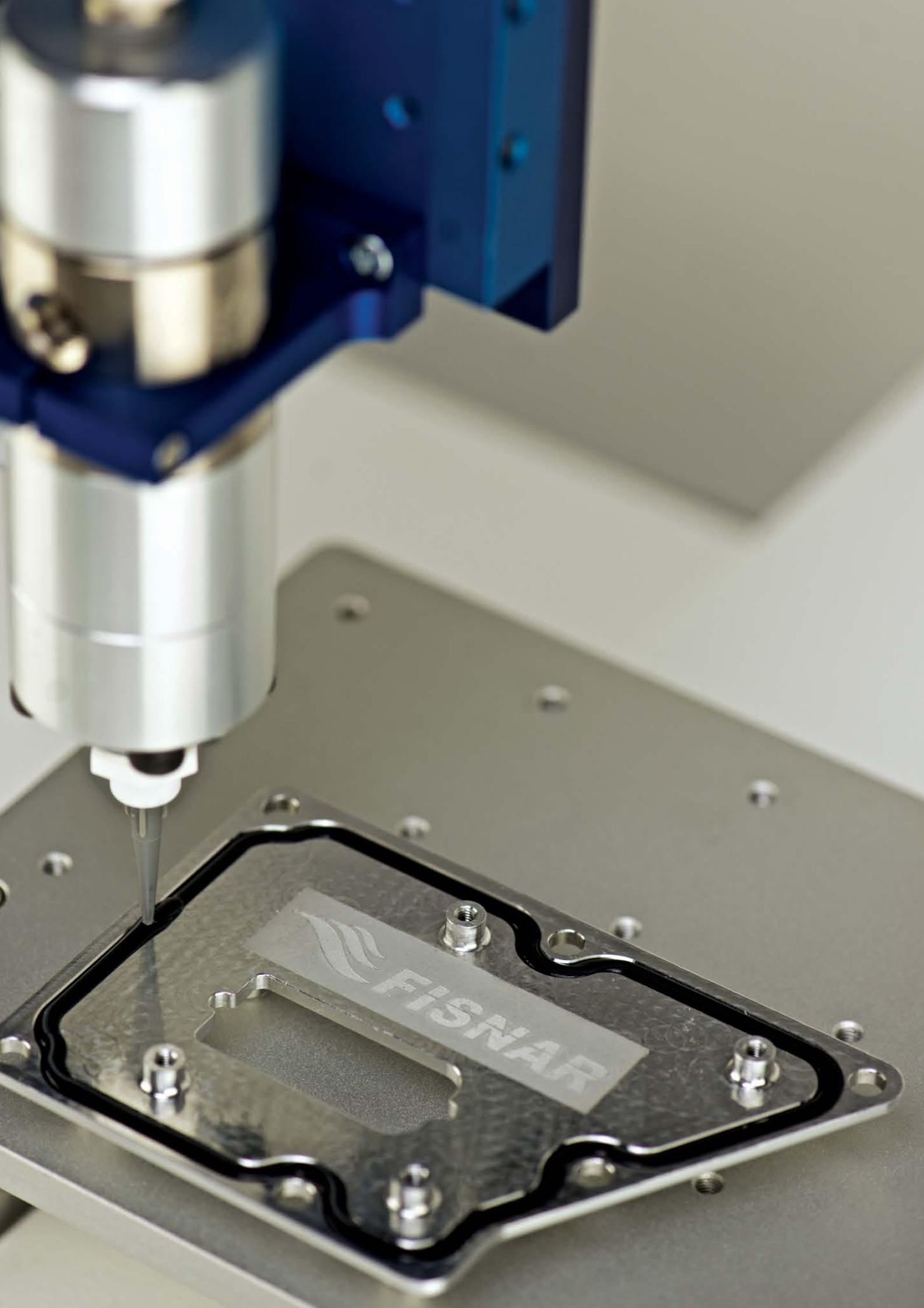

Liquid Dispensers



SL101N Economy Dispenser

An automatic digital dispenser with a bright LCD display and “teach and learn” process programming feature. Up to 9 independent dispensing programs may be stored for fast recall.

Modes:

Manual Mode: The dispense operation is manually controlled by a foot pedal.

Timed Mode: Dispenses at a pre-set time.

Auto Cycling Mode: Combines a dispense time and pause time and will continue to repeat the cycle until foot pedal is actuated.



DISPENSERS

Features

- Digital timer for precise and repeatable dispense control
- Durable aluminum housing designed for industrial work environments
- Vacuum suck-back control to prevent fluid dripping from dispense tip
- 9 programmable memory storage locations



Item Number	Description
-------------	-------------

560021U	Syringe Barrel Stand <i>Stand sold separately.</i>
---------	---

Item Number	Description
SL101N	Economy Digital Dispenser

Specifications

Dispense Time	0.01-9999secs
Cycle	Manual, Timed, Cycle
Internal Memory	9 save locations
Air Input	70-100psi
Air Output	1-100psi
Voltage	100-240 VAC - 50/60 Hz
Dimensions (WxDxH)	8.63" x 8.50" x 2.63"
Weight	1.59kg
Standards	CE Approved, RoHS Compliant

DC100 Precision Dispenser

A versatile precision dispenser designed to suit a wide variety of dispensing applications: from microdot deposits and lines, to large potting and filling. Integral and intelligent dispense software allows the user more control over dispensing applications.

Programmable alarms can be set to notify the user when material life has ended or fluctuations in dispensing pressure have occurred. The user-friendly programming allows for up to 10 programs saved and 5 different dispense modes.



Features

- Digital display readout of air output and vacuum pressure
- Air input alarm can be set for monitoring consistent air input pressure
- Dispense control lockout function to prevent programs from being modified
- Auto-purge cycle to prevent premature curing of material
- Dispense counter for tracking dispense cycles



Item Number	Description
560021U	Syringe Barrel Stand <i>Stand sold separately.</i>

Item Number	Description
DC100	Precision Digital Dispenser

Specifications

Cycle Rate	600+ cycles/min
Dispense Time	0.008 to 9999secs
Programs	10 Memory Slots
Input AC to Power Supply	100-240 VAC-50/60Hz
Output DC from Power Supply	24 VDC - 0.75 Amp
Air Input	70 - 100psi
Air Output	1 - 100psi
Operating Temperature	50-140 °F
Relative Humidity	20-90% (No Condensations)
Dimensions (WxDxH)	7.09" x 7.68" x 3.15"
Weight	0.86kg
Standards	CE Approved, RoHS Compliant

PPD-130 Peristaltic Pump Dispenser

Peristaltic pump dispensers transfer low-viscosity liquids by pressure displacement applied to a turning rotor against a tube-carrying fluid.

The PPD-130 offers excellent features for air-free positive displacement dispensing of materials, such as cyanoacrylates, solvents, acids, and other low-viscosity materials.

Dispense outputs can be timed from 0.01 - 99.99 seconds with flow speeds from 0.01 - 6ml/min using PTFE tubing. The pump is bidirectional allowing snuff-back after discharge to prevent dripping.



Features

- Forward and reverse motion
- Adjustable interval before reverse direction
- Continuous or timer modes
- Output signal to indicate end of cycle
- Large segment digital LED display
- Air-free dispensing
- Instant reverse for snuff-back of liquid flow

Item Number	Description
PPD-130	Peristaltic Pump Dispenser

Specifications

Cycle Rate	0.01-99.99secs
Flow Speed	0.01-6ml/min
Rotor Speed	Up to 120rpm
Dispense Pressure	Over 105kg/cm ²
I/O	Connection for Remote Operation
Input Voltage	110-240 VAC - 50/60Hz
Dimensions (WxDxH)	7.18" x 3.20" x 6.73"
Weight	2.99kg
Standards	CE Approved, RoHS Compliant

PPD-130 Accessories

The PPD-130 comes with a range of accessories, tubing, and nozzles. Optional pump heads and foot pedal available for advanced application requirements. Comes supplied with standard pump head 562030-T.

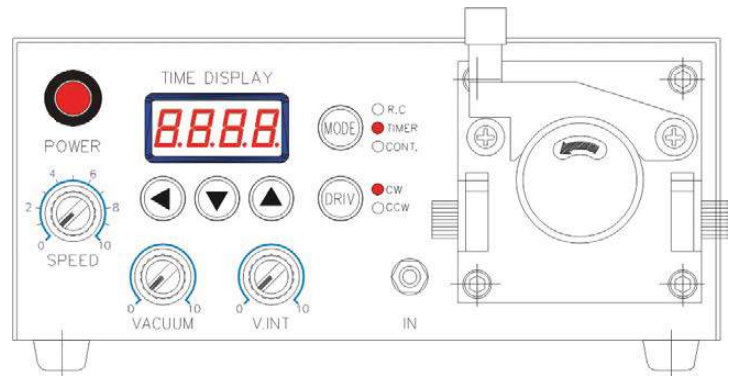

Included Accessories

Item Number	Description	Item Number	Description
560989-D	Nozzle Holder (with switch)	560984P-10FT	10ft (304.8mm) 1.0 x 1.6mm
561010-D	Nozzle 1.7mm diameter	560985P-10FT	10ft (304.8mm) 1.4 x 2.0mm
561011-D	Nozzle 2.1mm diameter	560995P-10FT	10ft (304.8mm) 1.9 x 2.5mm
561012-D	Nozzle 2.6mm diameter	560996A-10FT	10ft (304.8mm) 2.4 x 3.0mm
561013-D	Nozzle 3.5mm diameter	562031-D	9-pin connector

Sold Separately

Item Number	Description
562032-D	Foot Pedal (optional)

Tubing, Nozzles & Optional Pump Heads

Standard Pump Head

Item Number	Clear Tubing	Black Tubing	I.D. x O.D. (mm)	Suitable Nozzle Type	Nozzle Dimensions
562030-T	560984P-10FT	560984BA-10FT	1.0 x 1.6	561010-D	1.7mm
562030-T	560985P-10FT	560985BA-10FT	1.4 x 2.0	561011-D	2.1mm
562030-T	560995P-10FT	560995BA-10FT	1.9 x 2.5	561012-D	2.6mm
562030-T	560996A-10FT	560996BA-10FT	2.4 x 3.0	561013-D	3.5mm

Optional Pump Head

Item Number	Clear Tubing	Black Tubing	I.D. x O.D. (mm)	Suitable Nozzle Type	Nozzle Dimensions
562030-M	560997P-10FT	560997BA-10FT	0.25 x 0.75	-	-
562030-S	560998A-10FT	560998BA-10FT	0.50 x 1.00	561008-D	0.9mm
562030-S	560999A-10FT	560999BA-10FT	0.60 x 1.00	-	-

Pistol Grip Switch Assemblies

The pistol grip electronic switch assembly is designed to hold a metal cartridge retainer or 790HP valve. Allows better dispense control while reducing operator fatigue. Comes in two 3-pin configurations depending on controller connection point in back of unit.

Cartridge Pistol Grip Assembly

Item Number	Description
560598	For use with SL101N
560598DC	For use with DC100/DC200



790HP Valve Pistol Grip Assembly

Item Number	Description
560565	For use with SL101N
560565DC	For use with DC100/DC200



Metal retainer and 790HP valve sold separately.

DISPENSERS

Finger Switches

Designed for use in situations where it is not convenient to use a foot pedal or for operators who prefer to use finger switches when actuating the dispense controller. These finger switches are easily adjustable and can be fitted to a wide range of cartridges, retainers, and barrels.

Cartridge Retainer Switches

Item Number	Description
FS-501V	For use with SL101N
FS-501VDC	For use with DC100/DC200



Barrel Switches

Item Number	Description
560023-LF	For use with SL101N
560023-LFDC	For use with DC100/DC200



Metal retainer, syringe barrel and receiver head sold separately.

ATD200C Autotube Dispense Kit

The autotube system was designed to dispense liquids, pastes, greases, silicones, and similar materials directly from the manufacturer's collapsible metal tube.

Dispensing is controlled by either a foot valve or timed dispenser for a controlled shot.

The autotube assembly can be handheld, utilized with pistol grip handle, or mounted on a stand.

Features

- Eliminates waste
- Improves operator safety
- Prevents tube damage
- Clean and easy dispense method
- Reduces risk of contamination



Controller and squeeze tubes sold separately.

Pistol Grip Handles (sold separately)

560598DC

Use with DC-style Controllers



560598

Use with Non-DC-style Controllers



For small and large metal squeeze tubes.

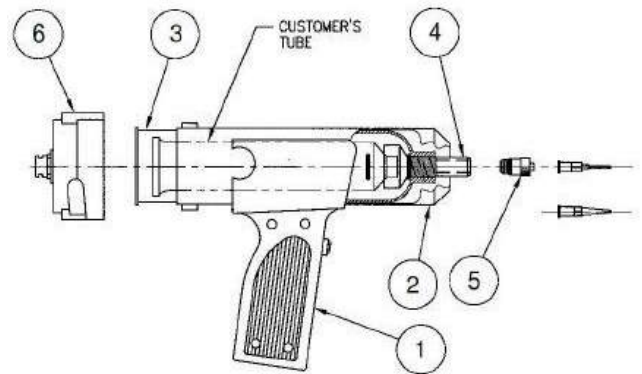

ATD200C

Item Number	Description	Reference ID
5601357	Connecting Hose (5ft)	-
560517A	8oz Cartridge	3
918-034-000	8oz Cartridge Retainer	2
5601376	Retainer Cap	6
A-10001-OT	Luer Lock Tip Adapter	5
880001-A	Adapter M13x1	4
880001-B	Adapter M14x2	4
880001-C	Adapter M12x1.75	4
880001-D	Adapter M18x1.25	4
880001-BLANK	No Thread Adapter	4
QK-NSK	Needle Selection Kit	-

TD101 Pneumatic Tube Dispenser

The TD101 dispenser is engineered to specifically address the waste and discomfort that result from dispensing materials in collapsible tubes. Its comfortable, balanced design protects the tube from damage and the operator from material contact.



Features

- Eliminates waste when dispensing from tubes
- Avoids material contamination
- Improves operator safety
- Prevents tube damage

Specifications

Maximum Tube Size	7.38"
Cycle	Manual (trigger actuated)
Start Pressure	Recommended at 20psi (1.38 bar)
Maximum Pressure	50psi (3.45 bar)
Size	7.5" x 3" x 6.75"
Weight	272g (without tube)

Dispensing Configurations:

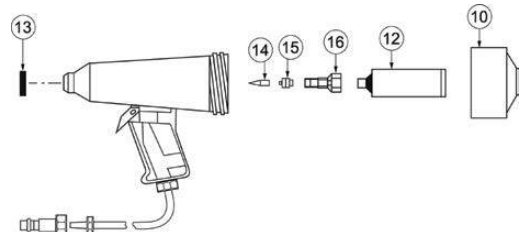
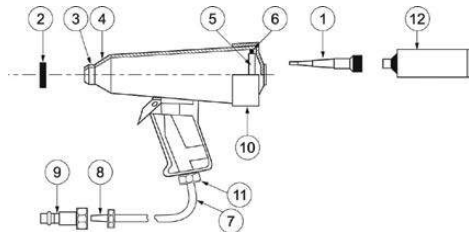

Using the Supplied Nozzle

Item Number	Description	Reference ID
910-TN	Nozzle	1
560699	Nozzle Nut	2
560698	O-Ring	3
560697	Lock Ring	4
560696	Retaining Ring	5
560695	Seal	6
560702	Cap Only	10
-	Tube (not included)	12

Using with Luer Lock Tips

Item Number	Description	Reference ID
560707	Adapter Nut	13
880001-A	Adapter M13 x 1	16
880001-B	Adapter M14 x 2	16
880001-C	Adapter M12 x 1.75	16
880001-D	Adapter M18 x 1.25	16
880001-BLANK	No Thread Adapter	16
QK-NSK	Needle Selection Kit	Not Shown
A-10001-OT	Luer Lock Adapter	5
560702	Cap Only	10
-	Tube (not included)	12

Dual Cartridge Dispense System

The dual cartridge dispense system (DCD) is an excellent cost-effective solution for low-volume mixing and dispensing of two-part materials supplied in dual cartridges. The fully portable bench-mounted system is simple to set up and program for accurate two-part dispensing.

DCD systems include a pneumatically actuated piston dispenser which applies pressure to accurately dispense materials contained in a dual cartridge.

Models	
Item Number	Description
DP50-1	50ml Cartridge System
DP200-1	200ml Cartridge System
DP400-1	400ml Cartridge System

Features

- Mounted on a robust bench support to allow for height and angle adjustment when dispensing
- Includes 710PT-LF pinch valve for increased accuracy and drip-free dispensing of low viscosity materials
- Supplied foot pedal allows for hands-free operation



Optional controller sold separately for timer controlled dispensing.

Specifications

Air Input	70-100psi
Air Output	1-100psi
Pressure Adjustments	Variable
Pneumatic Connections	1/4"
Weight (without foot pedal)	32lbs (14.5kg)
Foot Pedal Weight	4lbs (1.8kg)
DP50-1 Weight	1.45lbs (0.7kg)
DP200-1 Weight	3.52lbs (1.6kg)
DP400-1 Weight	4.85lbs (2.2kg)
Machine Directive	2006/42/EC

DTD50 50ml Dispenser

The DTD50 is a pneumatically controlled dispense tool for precisely dispensing two-part materials packaged into 50ml dual cartridges.

With its simple design and operation, accurate and repeatable fluid deposits are quickly and easily created when connected to a dispense controller.



DC100 controller, cartridge, and mix nozzle sold separately.

Item Number	Description
DTD50	50ml Dispenser

Specifications

Air Input	1-100psi (6.9 Bar)
Dimensions	5.5" x 2.3"
Weight	280g
Material	Aluminum and Acetal

DISPENSERS

Features

- Lightweight and durable design
- Use as a handheld device or mounted on a stand or robot for hands-free dispensing
- Suitable for all ratio sizes including: 1:1, 2:1, 4:1, and 10:1

Dispensing Configurations:

Lever Actuated with Finger Switch
(FS-501V or FS501-VDC)



Pistol Grip Hand Assembly
(560565 or 560565DC)



Stand Mounted Assembly
(562043U)



Robot Mounted Assembly
(5601800U)



All items shown sold separately.

DB815-SB Foot Dispenser

The DB815-SB foot dispenser is a basic air powered dispensing system. Floor stationed and foot actuated, fluid will be dispensed only when the foot pedal is pressed.

A three-way air valve is included along with a built-in air regulator. The suck-back control ensures that low viscosity liquids do not drip.

Suitable for dispensing all types of fluids.



Features

- Economical and simple to use
- Suitable for a wide range of applications
- Barrel suck-back control
- All pneumatic operation

Item Number	Description
DB815-SB	Foot Dispenser

Specifications

Cycle	Maintained by User
Foot Pedal	Air Valve in Unit
Air Input	70-100psi
Air Output	1-100psi
Dimensions (W x D x H)	4.5" x 8.50" x 5.38"
Weight	1.72kg

VPPE511-LF Vacuum Pick-Up System

This vacuum pick-up system is designed for delicate handling of small parts and components including miniature, surface mount, and chip scale packages. Features an air solenoid vacuum electrically activated by pressing a foot pedal.



Features

- Foot pedal controlled
- Adjustable suck-back control
- Vacuum pressure readout
- 560046LL-NH for use with VPPE511-LF

Specifications

Cycle	Foot Pedal Control
Air Input	20-100psi
Vacuum	Vacuum Gauge Display
Size	5.50" x 7.00" x 2.63"
Weight	1.14kg

VPP803-LF Vacuum Pick-Up System

The VPP803-LF vacuum pick-up system is designed for delicate handling of small parts and components including miniature, surface mount, and chip scale packages. The VPP803-LF is a non-electrical unit that has a vacuum pencil with a small hole that creates a vacuum.

Features

- Adjustable vacuum control
- Manually actuated
- All pneumatic operation
- 560046LL for use with VPP803-LF

Models

Item Number	Description
VPPE511-LF	Electric Vacuum Pick-Up System
VPP803-LF	Non-Electrical Vacuum Pick-Up System



Specifications

Cycle	Continuous
Air Input	20-100psi
Vacuum	Up to 16in hg
Size	3.75" x 7.00" x 2.63"
Weight	0.341kg



Vacuum Pick-Up Systems Accessories

Item Number	Description
560047	Vacuum Pad 0.140" (3.5mm)
560048	Vacuum Pad 0.200" (5.1mm)
560049	Vacuum Pad 0.250" (6.4mm)
560050	Vacuum Pad 0.320" (8.1mm)
560051	Vacuum Pad 0.400" (10.2mm)
560052LL	Vacuum Tip #14 0.063" (1.60mm)
560053LL	Vacuum Tip #18 0.033" (0.84mm)
560054LL	Vacuum Tip #21 0.020" (0.51mm)
560046LL	Vacuum Pick Up Pencil
560046LL-NH	Vacuum Pick Up Pencil (no hole)

700PTPCW Pinch Tube Pen

Pinch tube pens are ideal applicators for manually dispensing continuous beads or applying microdots of low viscosity liquids such as solvents and cyanoacrylates.

The disposable pinch tube is the only part of the pen that is in contact with the material and discarded when contaminated. The pinch tube pen can be connected via a wide range of interchangeable fittings to gravity fed or pressurized reservoirs.

Replacement Parts & Accessories

Item Number	Description	Included with 700PTPCW
5601390	Luer Lock Adapter - White	Yes
580045A	Pinch Tube (I.D. 0.10" x 4.10" long) - Clear	Yes
580047A-07-24	Fluid Line PE (I.D. 0.07" x 24" long) - Clear	No
580047A-10-18	Fluid Line PE (I.D. 0.10" x 18" long) - Clear	No
580047A-10-24	Fluid Line PE (0.10" x 24" long) - Clear	Yes
580047A-10-36	Fluid Line PE (I.D. 0.10" x 36" long) - Clear	No
580045A-BLK	Pinch Tube (I.D. 0.10" x 4.10" long) - Black	No
580047A-BLK-07-24	Fluid Line PE (I.D. 0.07" x 24" long) - Black	No
580047A-BLK-10-24	Fluid Line PE (I.D. 0.10" x 24" long) - Black	No
580047A-BLK-10-36	Fluid Line PE (I.D. 0.10" x 36" long) - Black	No



IJ2601N-SS-SP reservoir sold separately.

560666 Gravity-Fed Bottle

500ml gravity-fed bottle for use with low-viscosity fluids for dispensing small amounts of material.

Replacement Parts

Item Number	Description
560666	500ml Bottle with Luer Lock Cap
560670U	Gravity Feed Bottle Stand
580047A	Fluid Line PE
700PTPCW	Pinch Tube Pen



Stand, pinch tube pen, fluid lines, and needle sold separately.



Dispensing Valves

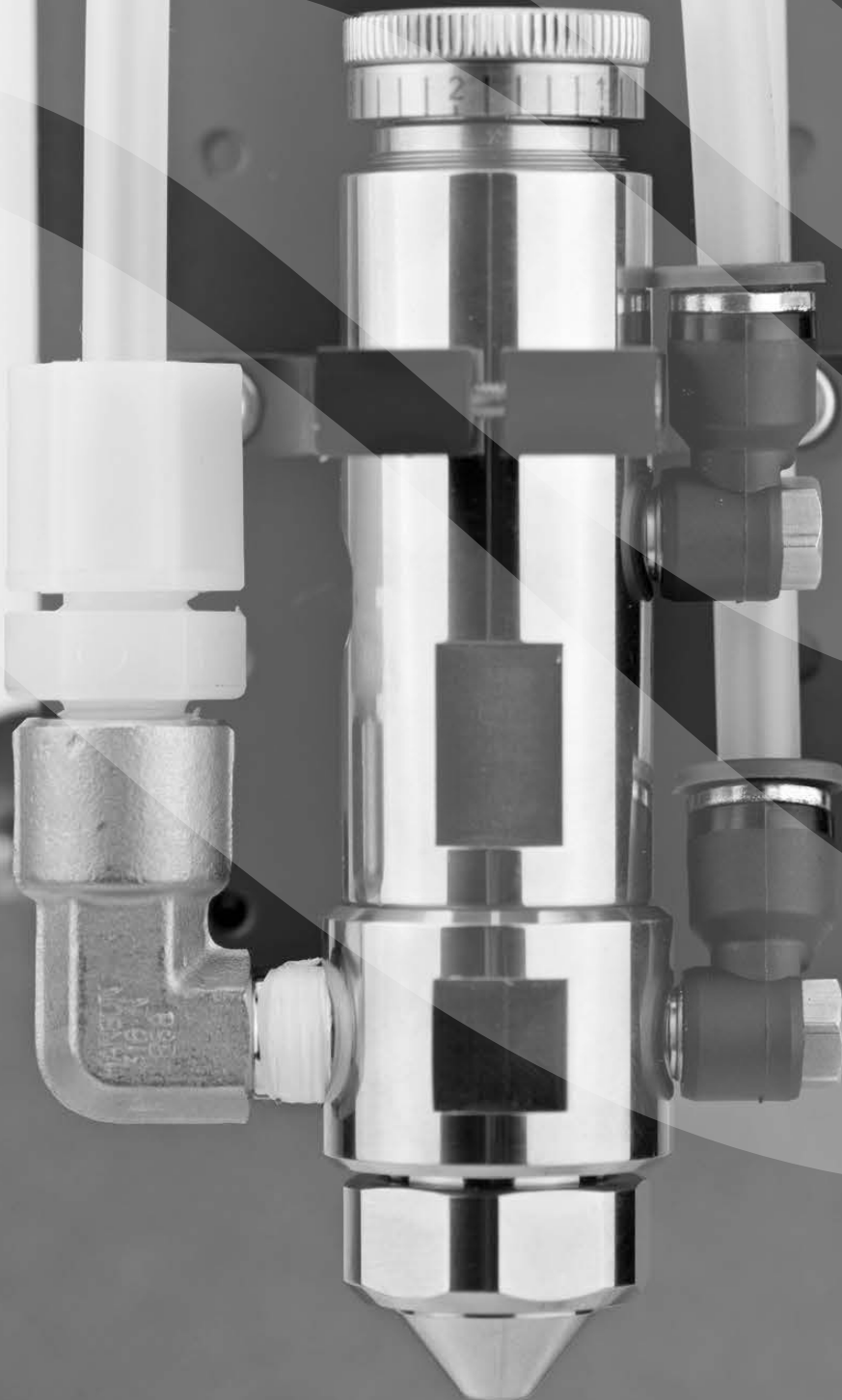



Dispensing Valves Selection

A wide selection of valves available for different fluid types and applications. This chart provides a quick guide for recommended valve options by matching the application (horizontal) to the fluid type (vertical).

Materials	Dots	Micro Dots	Beads/Lines	Potting/Filling	Spray
Acid/Solvent	VD510-SS, 710PT-LF	VD510-SS, MV-0180SS	VD510-SS, 710PT-LF	VD510-SS, 790HPSS-LF	SV1000SS
Anaerobic	VD510, 710PT-LF	VD510, 710PT-LF	VD510, 710PT-LF	VD510, 710PT-LF	-
Cyanoacrylate	VD510, 710PT-LF	VD510	VD510, 710PT-LF	VD510, 710PT-LF	-
1-Part Epoxy	VP300, 790HP-LF, PDV-1000, VMS400	PDV-1000	VP300, 790HP-LF, PDV-1000, VMS400	VP300, 790HP-LF, VMS400	-
2-Part Epoxy	710PT-LF	-	710PT-LF	710PT-LF	-
Grease/Gel	790HP-LF, VMS400	MV-0180LF	790HP-LF, VMS400	790HP-LF	-
Ink/Paint	VD510, VMP30H	MV-0180LF	VD510, VMP30H	VP300	SV2000N, SV1000SS
Liquid Flux	VD510, 710PT-LF	MV-0180SS	VD510, 710PT-LF	VMS400	SV2000N, SV1000SS
Lubricant/Oil	VD510	MV-0180LF	VD510, MV-0180LF	VP300, 790HP-LF	SV2000N, SV1000SS
Paste	VP300, 790HP-LF, PDV-1000	PDV-1000	VP300, 790HP-LF, PDV-1000	VP300, 790HP-LF	-
Reagent	VD510, MV-0180SS	VD510, MV-0180SS	VD510, MV-0180SS	VD510, 790HP-LF	-
RTV/Sealant	VP300, 790HP-LF	VMS400	VP300, 790HP-LF	VP300, 790HP-LF	-
Solder Mask	CV629, VMS400	MV-0180LF	CV629, VMS400	CV629, VP300	-
Solder Paste	PDV-1000	PDV-1000	PDV-1000	-	-
UV Adhesive	VD510-UV	VD510-UV, MV-0180SS	VD510-UV, VMS400	VD510-UV, 790HPSS-LF	SV2000N, SV1000SS

710PT-LF Pinch Tube Valve

Engineered for precise control of low to medium viscosity liquids. The easy-to-use stroke control adjustment knob ensures accurate and repeatable dispense volumes.

The disposable pinch tube design allows for quick and easy servicing of the valve. Piston on/off actuation causes the pinch tube to open or close allowing material to flow through the valve.

The shot size or flow rate is determined by the degree of adjustment in releasing the closed (pinched) tube and by the valve control timer.

Features

- Disposable pinch tube and fluid lines
- Suitable for low to medium viscosity fluids
- Ideal for 2-part epoxies and cyanoacrylates
- Easy to use and maintain

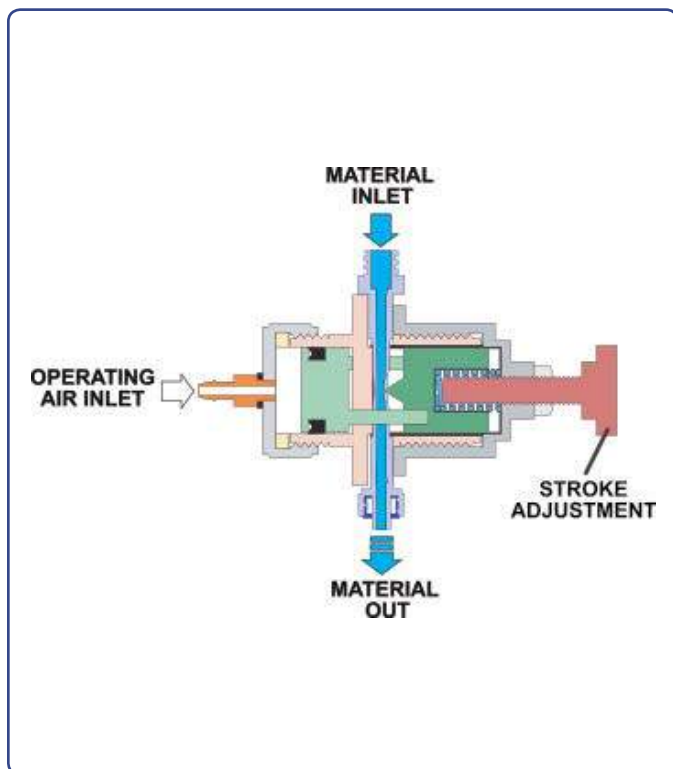

Item Number	Description
710PT-LF	Pinch Tube Valve

Specifications

Operating Air Pressure	60-75psi
Material Delivery Pressure	100psi max
Valve Construction	
Valve Body	Nylon
Valve Shut-Off Piston	Acetal
Valve Piston	Aluminum
Valve Cylinder Cap	Aluminum
Valve Flange Cap	Aluminum
Valve Stroke Adjustment Knob	Coated Steel
Valve Seals	NBR
Wetted Part Materials	Polyethylene
Connecting Ports	
Operating Air	1/8" Hose Barb
Material Inlet	Luer Lock
Material Outlet	Luer Lock
Mounting Hole Detail	1/4"-28 UNC
Weight	114g

Valve Stand (sold separately)

Item Number	Description
562054U	Valve Stand

*710PT-LF valves come with rod for mounting.

710PT-LF Pinch Tube Assembly

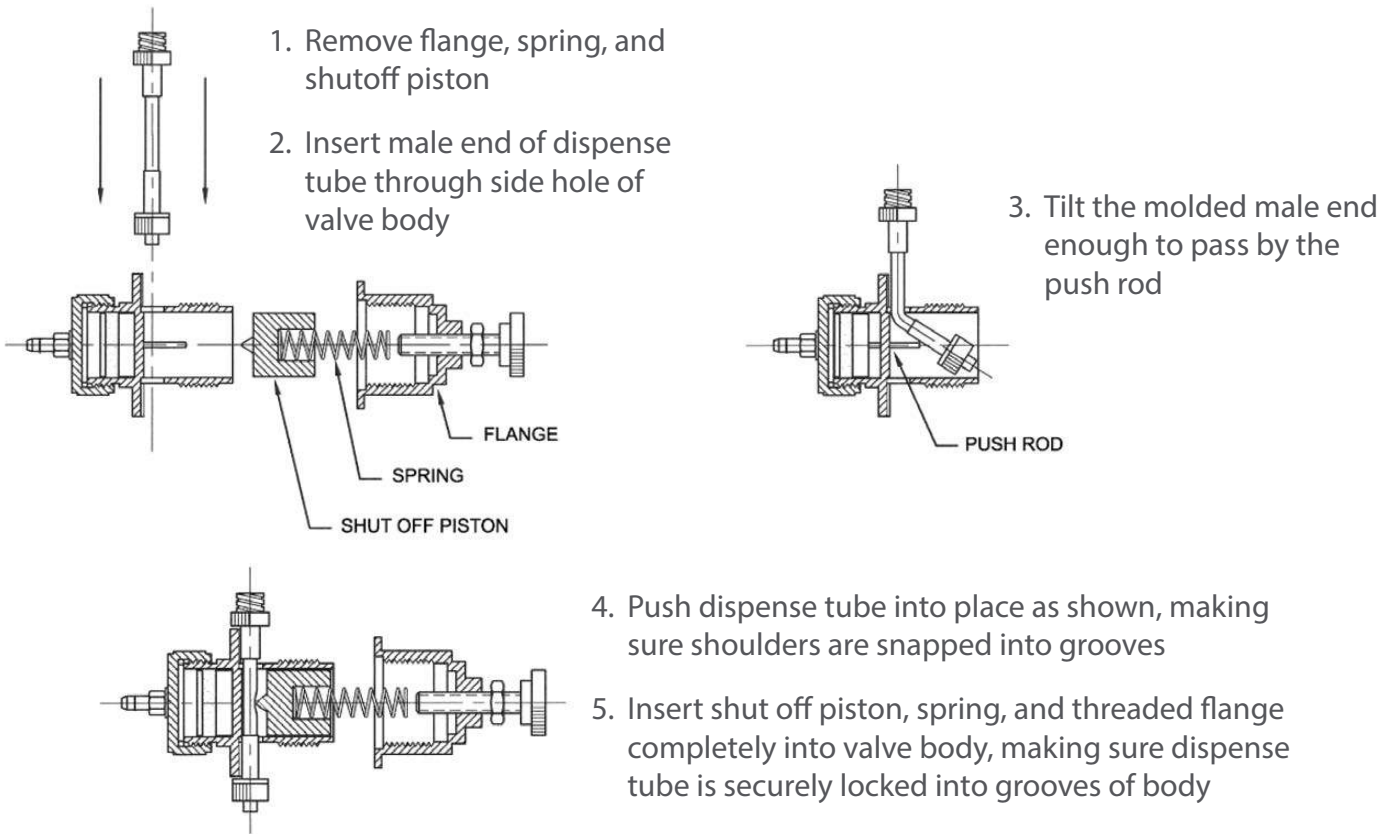

710PT-LF Pinch Tube Valve

Accessories

Item Number	Description
580038A	Pinch Tube Assembly (I.D. 0.07" (1.778mm))
580037A	Pinch Tube Assembly (I.D. 0.10" (2.54mm))
580047A-07-24	Fluid Line PE (I.D. 0.07" x 24" long (1.778 x 609.6mm)) - Clear
580047A-10-18	Fluid Line PE (I.D. 0.10" x 18" long (2.54 x 457.2mm)) - Clear
580047A-10-24	Fluid Line PE (I.D. 0.10" x 24" long (2.54 x 609.6mm)) - Clear
580047A-10-36	Fluid Line PE (I.D. 0.10" x 36" long (2.54 x 914.4mm)) - Clear
580047A-BLK-07-24	Fluid Line PE (I.D. 0.07" x 24" long (1.778 x 609.6mm)) - Black
580047A-BLK-10-24	Fluid Line PE (I.D. 0.10" x 24" long (2.54 x 609.6mm)) - Black
580047A-BLK-10-36	Fluid Line PE (I.D. 0.10" x 36" long (2.54 x 914.4mm)) - Black

VD510 Diaphragm Valve

The VD510 is a diaphragm valve designed for precise flow control of low to medium viscosity materials.

The diaphragm separates the wetted parts from the moving parts, thus making the valve ideal for dispensing cyanoacrylates, anaerobics, reagents, paints, UV adhesives, and other volatile substances.



Models

Item Number	Description
VD510	Diaphragm Valve
VD510-SS	Stainless Steel Diaphragm Valve
VD510-UV	UV Suitable Diaphragm Valve

Features

- Stroke adjustment to fine tune shots
- Separated wetted parts
- Easily serviceable
- Suitable for anaerobic fluids
- Positive shut off design

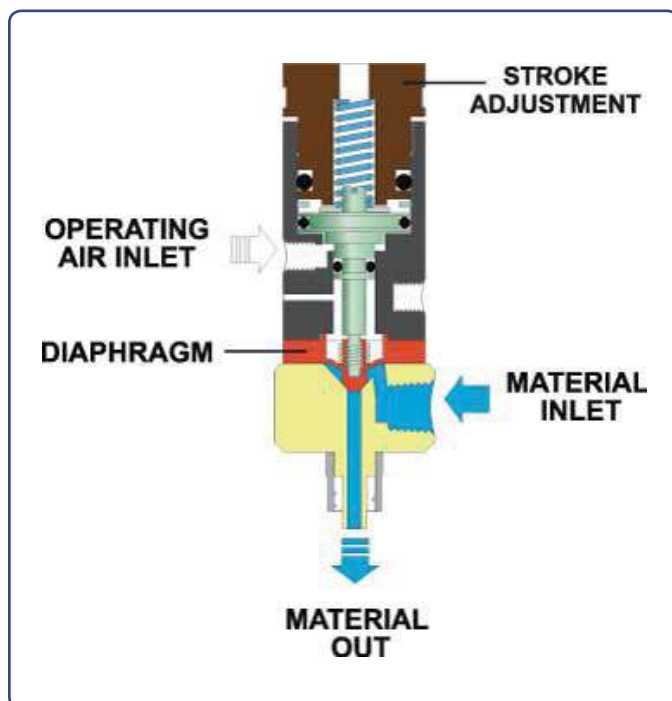

Specifications

Operating Air Pressure	70-100psi
Material Delivery Pressure	100psi max
Flow Rate Maximum	0.3L/min
Valve Construction	
Valve Body	Aluminum/SS
Valve Piston	SUS303
Valve Piston Seal	NBR
Wetted Part Materials	UHMWE-PE
Connecting Ports	
Air Input	M5 x 0.8
Material Inlet	1/8" NPT
Material Outlet	Luer Lock
Mounting Hole Detail	M5 x 0.8
Weight (VD510/UV)	69g
Weight (VD510-SS)	121g

Valve Stand (sold separately)

Item Number	Description
562043U	Valve Stand

MV-0180 Micro Shot Needle Valve

Designed for precision dispensing of low viscosity fluids from micro shots to moderate-sized beads and dots. Its lightweight, pencil-type grip makes the valve suitable for either handheld or automated applications.

Shot size and flow rate are controlled by the tip size, fluid pressure, and the duration that the valve is open.



Models

Item Number	Description
MV-0180LF	Aluminum Needle Valve
MV-0180SS	Stainless Steel Needle Valve

Features

- SS version available for volatile and corrosive materials
- Stroke adjustment to fine tune shot size
- Positive shut-off
- Micro-shot deposits

Specifications

Operating Air Pressure	70-100psi
Material Delivery Pressure	120psi max
Valve Construction	
Valve Body	Aluminum/SS
Valve Piston	Aluminum
Valve Piston Seal	PTFE
Wetted Part Materials	Aluminum/SS
Connecting Ports	
Air Input	1/8" NPT
Material Inlet	1/8" NPT
Material Outlet	Luer Lock
Mounting Hole Detail	N/A
Weight (MV-0180LF)	173g
Weight (MV-0180SS)	270g

Valve Stand (sold separately)

Item Number	Description
560536U	Valve Stand

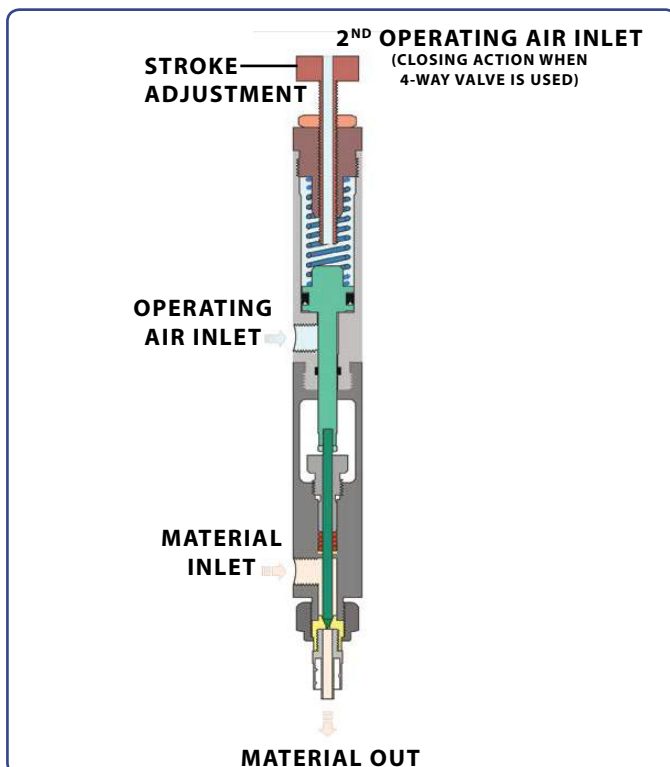

CV629 Cartridge Valve

The CV629 is a pneumatically-operated valve designed for precision dispensing of low to medium viscosity materials, such as solvents, oils, silicones, UV adhesives, inks, and more.

A simple design with accurate delivery.

Features

- Stroke adjustment to fine tune shot size
- Replaceable cartridge
- Micro-shot deposits
- High flow rate



Item Number	Description
CV629	Cartridge Valve

Specifications

Operating Air Pressure	70-100psi
Material Delivery Pressure	300psi max
Valve Construction	
Valve Body	Aluminum
Valve Needle	SS
Connecting Ports	
Operating Air Input	M5 thread with push-in fitting for O6 O.D. tube
Material Inlet	1/8" BSPP with push in fitting for O6 O.D. tube
Material Outlet	Luer Lock
Weight	135g

Valve Stand (sold separately)

Item Number	Description
562166U	Valve Stand

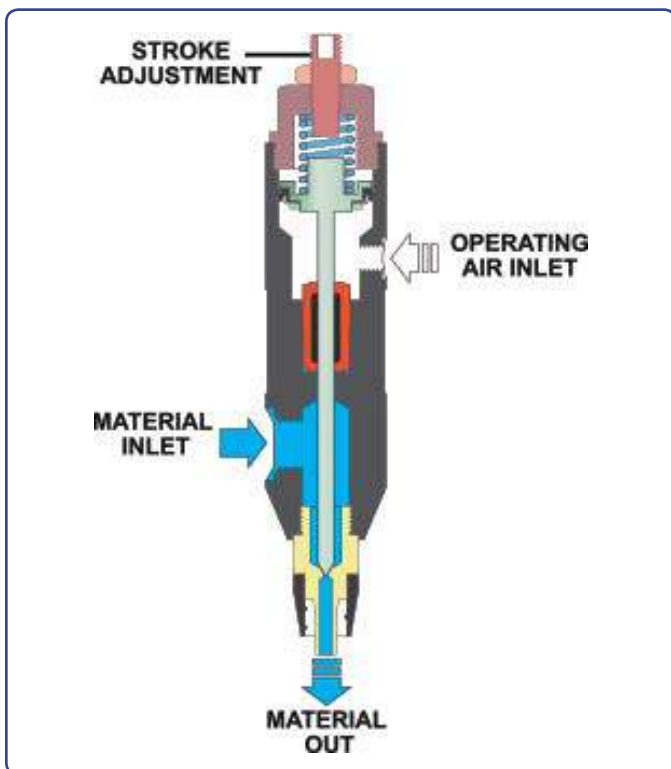

SV1000SS Stainless Steel Spray Valve

The SV1000SS spray valve provides close tolerance spray dispensing of fluids of up to 1000cps. It is constructed of stainless steel to prevent corrosion from volatile materials. Designed specifically for spraying flux, paint, oils, lubricants, and coatings for use in coating and marking applications.

The flow rate is controlled by turning the stroke-adjust at the top of the valve in order to set the spray volume. Coating area and flow rate are controlled by the fluid pressure, needle stroke, distance from the valve to the component, and the duration the valve is open.

This spray valve is used in conjunction with the SVC100 controller.

Features

- Stroke-adjust control
- Tunable spray pattern
- Adjustable coating and flow rate



Item Number	Description
-------------	-------------

SV1000SS	Spray Valve
----------	-------------

Specifications

Operating Air Pressure	70-100psi
Atomizing Air Pressure	1-30psi max
Fluid Viscosity Range	Up to 1,000cps

Valve Construction

Valve Body/Piston	SS
Valve Seals	PTFE
Fluid Pressure	1-100psi
Nozzle Diameter	0.028"
Operating Frequency	Up to 200 cycles/min

Connecting Ports

Operating/Atomizing Air Inlet	10-32
Material Inlet	1/8" NPT
Weight	344g

Valve Stand (sold separately)

Item Number	Description
-------------	-------------

562054U	Valve Stand
---------	-------------

SV1000SS valve comes with rod for mounting.

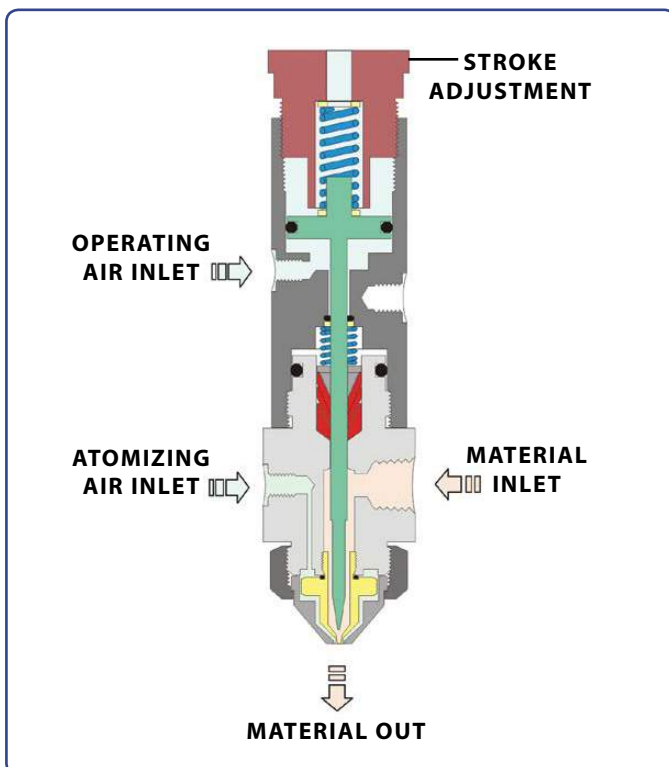

SV2000N Adjustable Spray Valves

The SV2000N series are no-clog spray valves and work best with low-viscosity materials, typically less than 1000cps. Material is typically fed to the spray valve from a pressure reservoir. Each valve is actuated by air pressure sequenced by a controller. The operating air pressure opens a needle valve allowing material to flow, while a separate airline creates pressure in the cap, atomizing the fluid.

Valve selection based on required spray area. This spray valve is used in conjunction with the SVC100 controller.



Models

Item Number	Description
SV2001N	Spray Valve Fine Dot & Bead
SV2002N	Spray Valve Medium Bead
SV2003N	Spray Valve Fan Pattern

Features

- Stroke-adjust control
- Tunable spray pattern
- Adjustable coating and flow rate

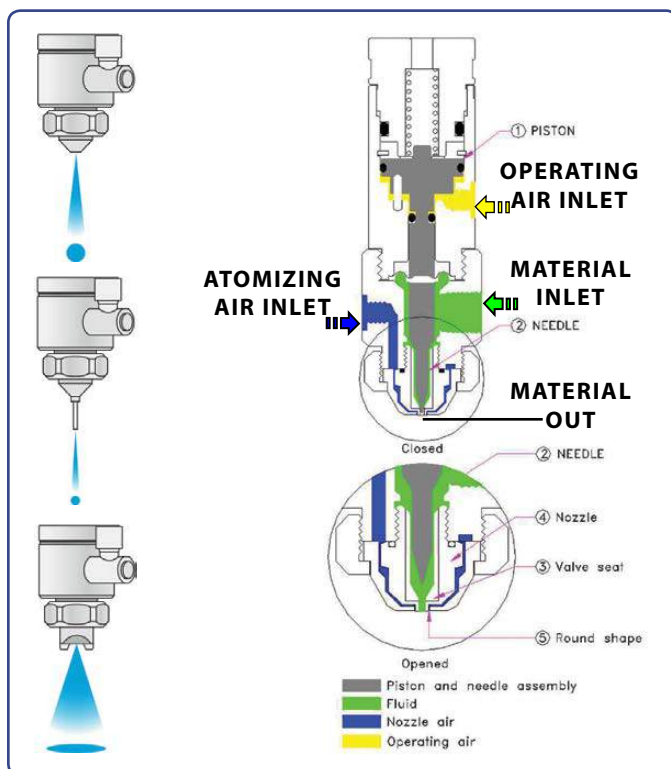

Specifications

Operating Air Pressure	70-100psi
Atomizing Air Pressure	1-30psi max
Fluid Viscosity Range	Up to 1,000cps
Valve Construction	
Valve Body/Piston	SS
Valve Needle	SS
Valve Diaphragm	UHMW-PE
Valve Seat	PEEK
Fluid Pressure	1-100psi
Operating Frequency	Up to 400 cycles/min
Spray Angle	SV2001N: 20° SV2002N: 30° SV2003N: 37°
Connecting Ports	
Operating/Atomizing Air Inlet	10-32
Material Inlet	1/8" NPT
Weight	236g

Valve Stand (sold separately)

Item Number	Description
562054U	Valve Stand

SV2000N valve comes with rod for mounting.

VP300 Poppet Valve

The VP300 is a multi-purpose, poppet-style, pneumatic valve designed for dispensing medium to high viscosity liquids such as silicone, epoxy, grease, solder paste, and other filled materials.

Its piston design maximizes fluid flow rate, while its sealing mechanism enhances valve durability.



Features

- Suck-back effect to prevent drooling at the end of the needle tip
- Suitable for filled materials
- Separated wetted parts
- Stroke adjustment to fine tune shot size

Item Number	Description
VP300	Poppet Valve

Specifications

Operating Air Pressure	70-100psi
Material Delivery Pressure	85psi max
Valve Construction	
Valve Body	Aluminum
Valve Piston	SUS303
Valve Piston Seal	NBR
Wetted Part Materials	
Chamber, Cap	Aluminum
Diaphragm, Seal	UHMW-PE
O-ring	Viton®
Connecting Ports	
Air Inlet	M5 x 0.8
Material Inlet	1/8" NPT
Material Outlet	1/4" NPT
Mounting Hole	M5 x 0.8
Weight	180g

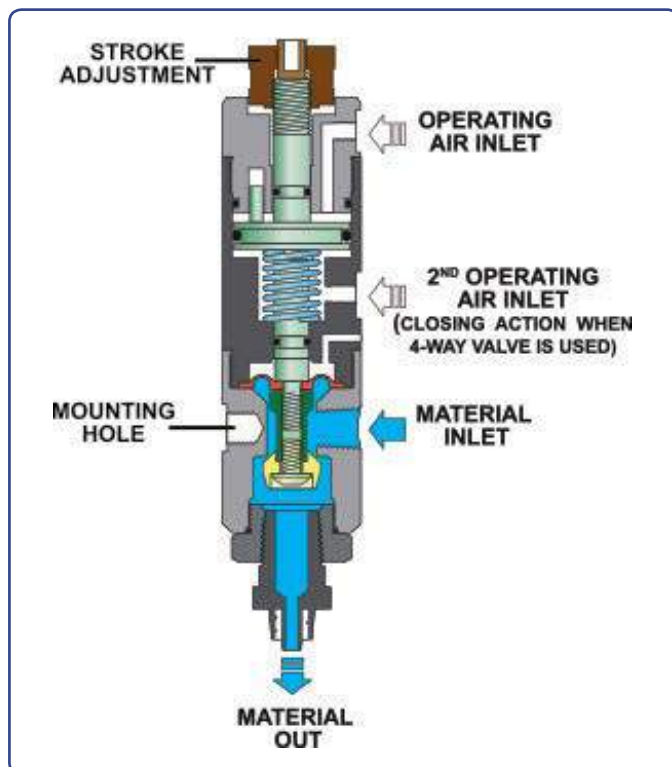

Valve Stand (sold separately)

Item Number	Description
562043U	Valve Stand

VMP30H

Mini-Poppet Valve

The VMP30H is a mini-poppet, pneumatic valve designed for dispensing small shots of medium viscosity materials. Its lightweight and compact design is beneficial for installation in confined work areas.

The poppet design minimizes surface area and friction between the valve piston and the material, making it ideal for filled materials and extending the life of the valve seals.

Features

- Suck-back effect to eliminate drooling at the end of the needle tip
- Suitable for filled materials
- Separated wetted parts
- Stroke adjustment feature for fine tuning shot size

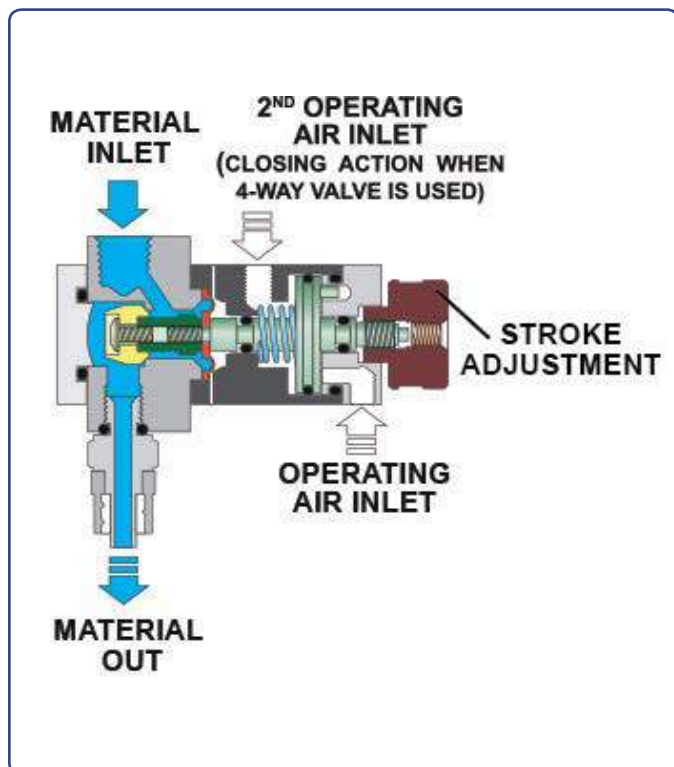

Item Number	Description
-------------	-------------

VMP30H	Mini-Poppet Valve
--------	-------------------

Specifications

Operating Air Pressure	70-100psi
Material Delivery Pressure	85psi max
Flow Rate	MAX 1.2l/min

Valve Construction

Valve Body	Aluminum
Valve Piston	SUS303
Valve Piston Seal	NBR

Wetted Part Materials

Chamber, Cap	SUS303
Diaphragm, Seal	UHMW-PE
O-ring	Viton®

Connecting Ports

Air Input	M5 x 0.8
Material Inlet	1/8" NPT
Material Outlet	Luer Lock
Weight	162g

Valve Stand (sold separately)

Item Number	Description
-------------	-------------

562235U	Valve Stand
---------	-------------

790HP-LF High-Pressure Valve

The 790HP-LF high-pressure spool valve offers an effective solution for dispensing high viscosity materials such as silicones, sealants, and grease.

A spring snap-back retraction closes the valve resulting in a suck-back at the fluid outlet to prevent dripping.

Features

- High-pressure fluid input up to 2,500psi
- Suitable for high-viscosity fluids
- SS version available for volatile and corrosive materials
- Easy to clean and maintain
- Extra pneumatic air-port for use with 4-way valve controller for rapid valve closure



Models

Item Number	Description
790HP-LF	Aluminum High Pressure Valve
790HPSS-LF	Stainless Steel High Pressure Valve

Specifications

Operating Air Pressure	70-100psi
Material Input Pressure	2500psi max
Valve Construction	
Valve Body	Aluminum/SS
Valve Piston	Aluminum
Valve Spool	SS (TiCN coated)
Valve Seals	UHMW PE
Valve O-ring	Viton®
Connecting Ports	
Air Input	1/4" NPT
Material Inlet	1/4" NPT
Material Outlet	1/4" NPT
Weight (790HP-LF)	524g
Weight (790HP-SS)	744g

Valve Stand (sold separately)

Item Number	Description
560671U	Valve Stand

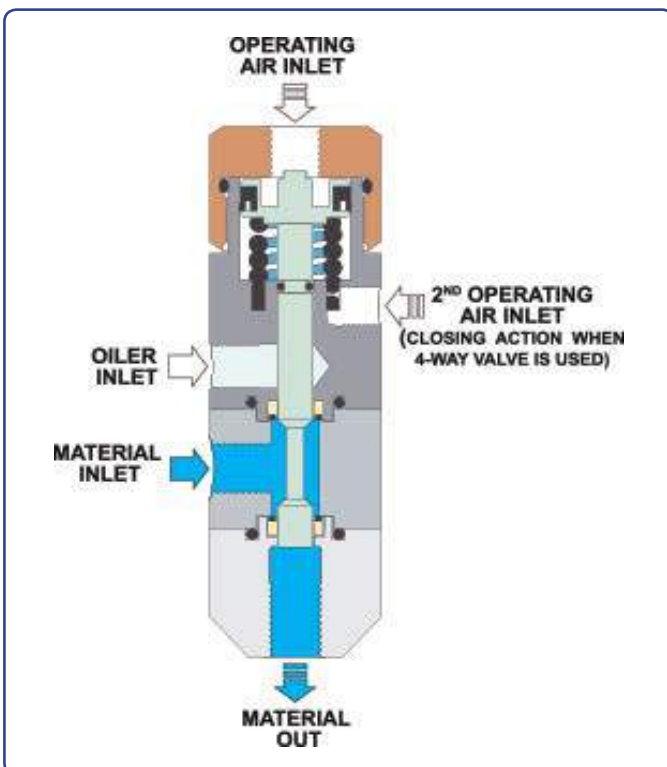

PDV-1000 Auger Valve

The PDV-1000 precision auger valve is suitable for medium to high viscosity epoxy, solder paste, and other filled materials. Capable of dispensing micro shots less than 1mm using an auger servo motor driven screw.

The PDV-1000 has zero dead space within the valve and can deliver accurate and repeatable dots and beads for any application, whether automated or manually operated.

This auger valve is used in conjunction with the RVC900N controller.

Comes standard with 3, 5, and 10cc bushings.



Features

- Ideal for heavily filled and abrasive materials
- Micro-shots less than 1mm
- Flexible coupling from motor to screw
- No dead space – high repeatability
- Disposable fluid feed tube

Models

Item Number	Description
PDV-1000-8P	8 Pitch Auger Valve (3,5,10,30/55cc)
PDV-1000-16P	16 Pitch Auger Valve (3,5,10,30/55cc)
PDV-1000-32P	32 Pitch Auger Valve (3,5,10,30/55cc)

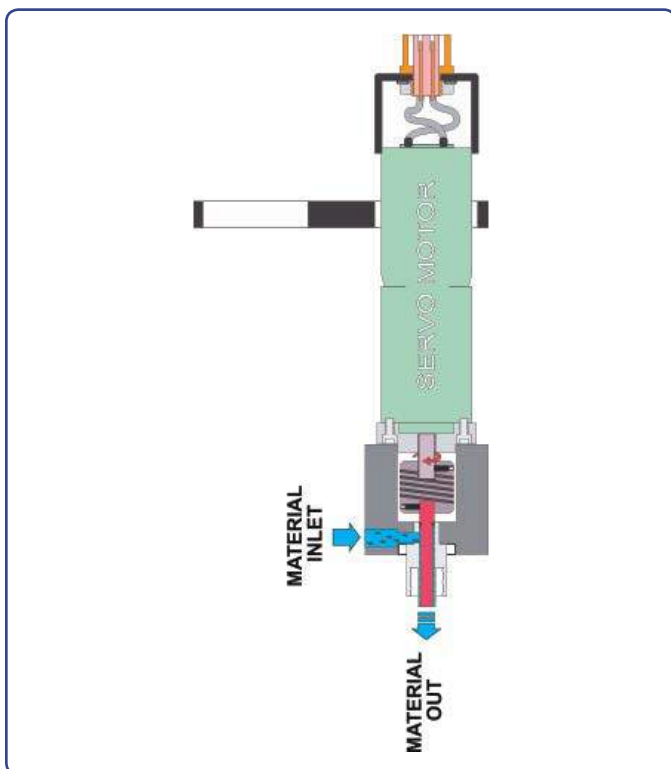

Specifications

Motor Voltage	24V
Motor	6 watt, 400RPM (no load)
Valve Construction	SS
Valve Body	Aluminum
Valve Auger	SS
Valve Syringe Bracket	Aluminum
Minimum Material Viscosity	35,000cps
Weight	212g

Valve Stand (sold separately)

Item Number	Description
562235U	Valve Stand

VDP150 Positive Displacement Valve

The VDP150 is a pneumatically-operated positive displacement valve designed for dispensing constant volume shots up to 0.15cc of low to medium viscosity material.

Featuring two integral check valves to control the flow of material, the valve is cycled by applying air pressure to the air ports. No fluid pressure is required for low-viscosity materials (less than 5,000cps) as the material is drawn into the displacement chamber by the plunger.

Features

- Positive displacement metering
- Integral inlet/outlet check valves
- Stroke adjustment to fine tune shot size



Item Number	Description
VDP150	Positive Displacement Valve

Specifications

Operating Air Pressure	70-100psi
Maximum Shot Size	0.15cc/cycle

Valve Construction

Valve Cylinder Body	Aluminum
Valve Piston	SUS303
Valve Check Body	SUS303, RULON

Wetted Part Materials

Valve Chamber, Cap & CV Body	SUS303
Valve Plunger	SUS420 (tin coating)
Check Valve	PEEK
Check Valve O-rings	FFKM

Connecting Ports

Air Input	M5X0.8
Material Inlet	1/8" NPT
Material Outlet	Luer Lock
Weight	323g

Valve Stand (sold separately)

Item Number	Description
562235U	Valve Stand

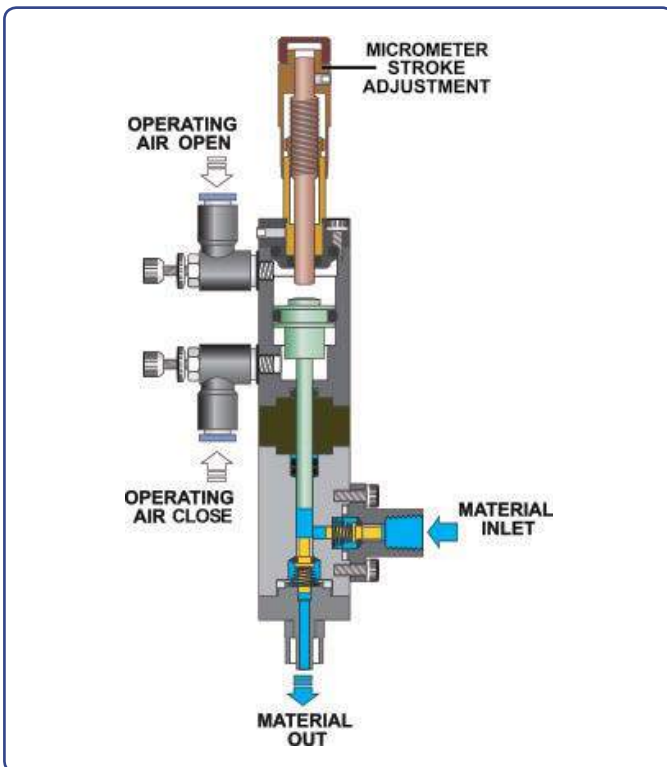

VMS400 Mini Spool Valve

The VMS400 is a mini-spool valve designed for dispensing small volumes of medium to high viscosity materials. When air pressure is applied to the air inlet of the valve, the spool will be forced forward and fluid will be dispensed.

Shot size and flow rate are controlled by the tip size, fluid pressure, and the duration that the valve is open.



Features

- High-pressure fluid input up to 700psi
- Suitable for high viscosity fluids
- Adjustable suck-back
- Stainless steel wetted parts for volatile and corrosive materials

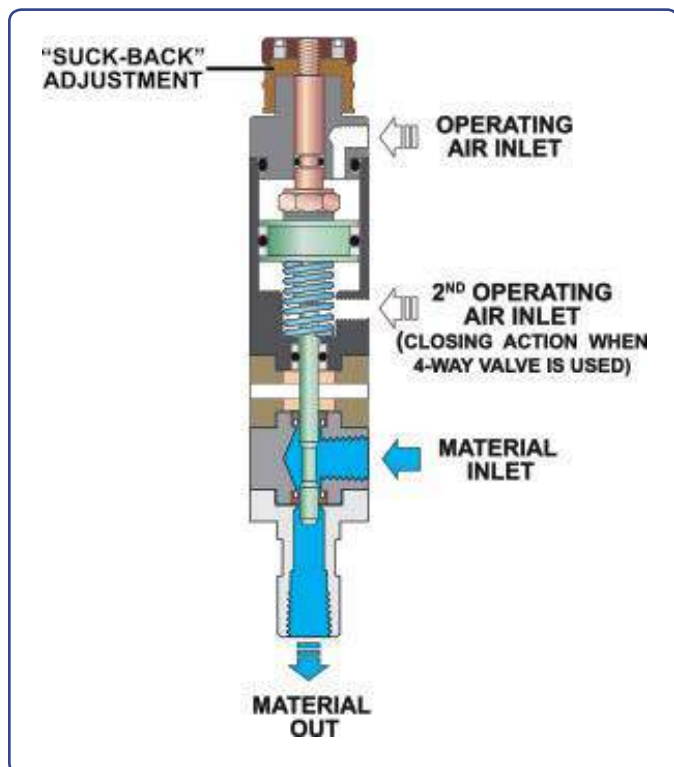

Item Number	Description
VMS400	Mini Spool Valve

Specifications

Operating Air Pressure	70-100psi
Valve Construction	
Valve Body, Piston	SUS303
Valve Spool	SUS420
Valve Cap	Aluminum
Wetted Part Materials	
Valve Chamber, Cap	SUS303
Valve Seal	UHMW-PE Lip Seal
Connecting Ports	
Air Inlet	M5 x 0.8
Material Inlet	1/8" NPT
Material Outlet	Luer Lock
Weight	255g

Valve Stand (sold separately)

Item Number	Description
562235U	Valve Stand

Workbench Stands



560021U
Syringe Barrel
Stand



560549U
CR300 Cartridge
Retainer Stand



560671U
790HP-LF
Valve Stand



560670U
Gravity Feed
Bottle Stand



560535U
Retainer Stand
2.5, 6, 8 and 12oz



560534U
20oz Retainer
Stand



562044U
PPD-130
Valve Stand



560536U
MV-0180
Valve Stand



562166U
CV629 Valve Stand



562043U
VD510, VP300
Valve Stand



562054U
SV1000SS*, SV2000N*,
710PT-LF* Valve Stand



562235U
VMP30H, PDV-1000,
VMS400, VDP150 Valve
Stand

*Rod included with SV1000SS, SV2000, and 710PT-LF valves.

DC200 Digital Valve Controller

A multi-purpose digital controller, recommended for use with Fisnar pneumatically-actuated valves. This system uses a highly responsive air pressure management system, coupled with a digital display to provide consistent repeatable control.

For use with 710PT-LF, VD510, MV-0180, CV629, VP300, VMP30H, 790HP, and VMS400 dispense valves.



560671U Stand and 790HP-LF Valve sold separately.

Item Number	Description
DC200	Digital Valve Controller

Features

- Air input tolerance can be set for consistent pressure
- Can be locked to keep programs from being modified
- Auto purge and glue alarm to prevent premature curing of materials
- Dispense counter for tracking completed dispense cycles
- Multiple dispensing modes for easy use in many applications
- I/O circuit for external control and robot integration

Specifications

Cycle Rate	600+ cycle/minute
Timer	0.008 to 9999secs
Programs	10 memory slots
Input AC to Power Supply	100-240 VAC-50/60Hz
Output DC from Power Supply	24 VDC - 0.75 Amp
Air Input	70-100psi max
Air Output	1-100psi
Dimensions (WxDxH)	7.09" x 7.68" x 3.15"
Weight	1kg
Standards	CE Approved, RoHS compliant

VC1195N 4-Way Valve Controller

A 4-way valve controller that can be used to control one or two valves simultaneously. The high flow, high speed, internal solenoid rapidly shuts off the dispense valve to prevent drooling and ensures consistent dispense results, by providing a constant air supply to the dispense valve. This ensures it remains in a closed position to prevent premature actuation.

For use with 790HP, VDP150, VMS400, VMP30H, VP300, and MV-0180LF dispense valves.



562235U stand and VDP150 Valve sold separately.

VALVES

Features

- Timing interval from 0.01 - 31 seconds
- Fast response internal pneumatic solenoid
- Actuated by foot pedal or remotely from a robot
- Manual and timer modes
- Can simultaneously control up to 2 valves

Item Number	Description
VC1195N	4-Way Valve Controller

Specifications

Dispense Time	0.01-31secs
Voltage	100-240 VAC 50/60Hz
Air Input	70 - 100psi
Air Output	1 - 100psi
Dimensions (WxDxH)	10.4" x 8.25" x 2.75"
Weight	1.9kg

SVC100 Spray Valve Controller

A fully integrated spray valve controller suitable for all Fisnar SV series spray valves. Simple setup and operation for a variety of basic and advanced spray applications.

The SVC100 spray valve controller allows the fluid dispense signal and atomizing air signal to be independently programmed to achieve a clean and precise spray pattern.



562054U stand and SV1000SS valve sold separately.

Features

- Timed or continuous spray
- Clean, clog-free cut off
- Easy integration with robotic platforms

Models

Item Number	Description
SVC100-110	110V Spray Valve Controller
SVC100-220	220V Spray Valve Controller

SVC100 Setup

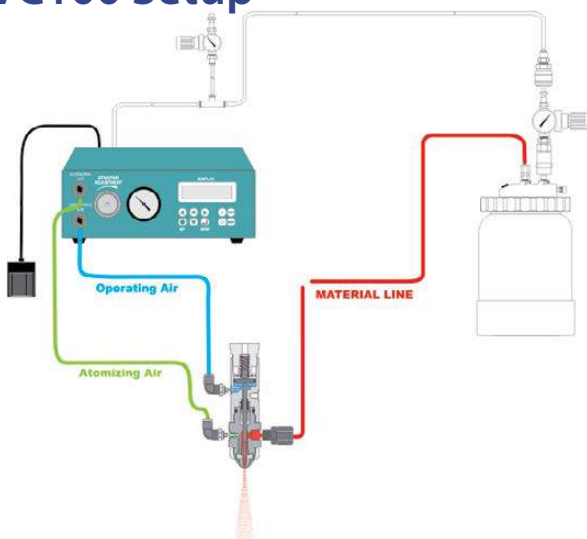

Specifications

Dispense Time	0.008-99.99secs
Voltage	
SVC100-110	110 VAC 50/60Hz
SVC100-220	220 VAC 50/60HZ
Air Input	70-100psi
Valve Air Output	70-100psi
Spray Air Output	1-60psi
Dimensions (WxDxH)	9.16" x 7.38" x 3.25"
Weight	2.72kg

RVC900N Auger Valve Controller

The RVC900N controls the PDV-1000 series of auger valves. The controller delivers accurate and repeatable dots and beads for any application, whether automated or manually operated.

Due to the constant motor speed output, any change in material viscosity does not impact the dispense flow rate. The controller supplies material pressure to the barrel, adjusted via a regulator and pressure gauge. A reverse timer and speed control can set the amount of controlled suck-back at the end of the dispense cycle.

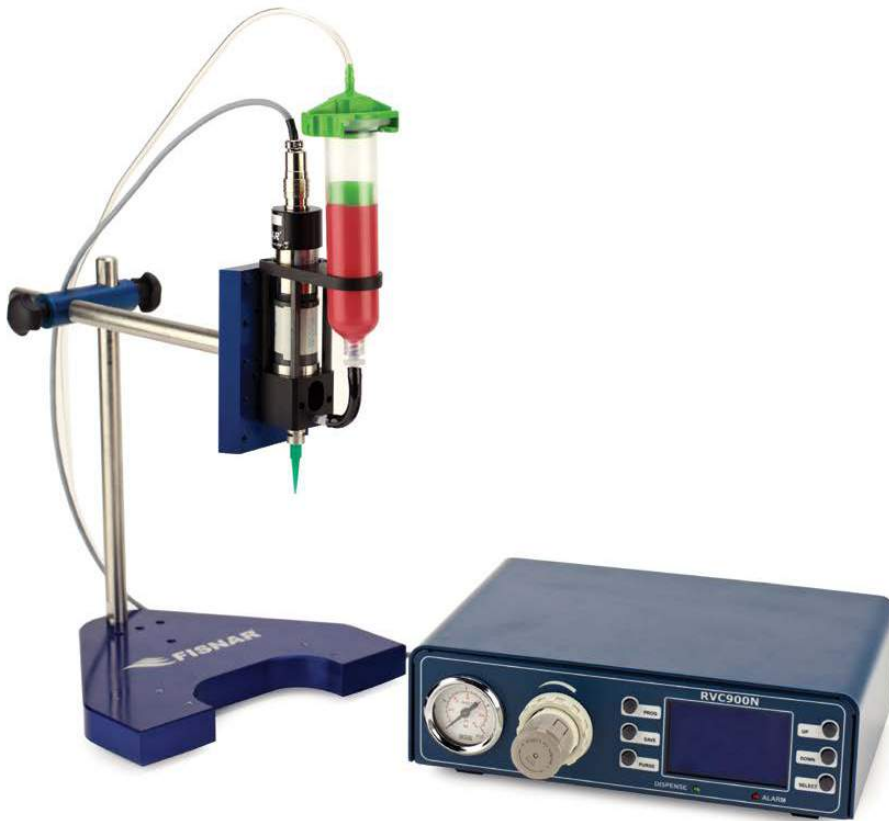

562235U stand and PDV-100 valve sold separately.

VALVES

Features

- Simple to program
- Up to 8 stored programs
- Auto or manual control
- Constant motor speed
- Adjustable forward and reverse speed and time

Item Number	Description
RVC900N	Auger Valve Controller

Specifications

Time Range	0.01-99.99secs
Voltage	100-240 VAC 50/60HZ
Output Pressure	1-60psi
Dimensions (WxDxH)	9.05" x 8.26" x 2.76"
Weight	1.65kg

Reservoirs & Pumps



IJ Series Reservoir Tanks

Reservoir tanks are used to feed bulk fluids to a variety of dispensing valves. A range of sizes are available including bottom ported for medium to high viscosity liquids and top ported for low to medium viscosities.

An "open top" style is used if liners are required to prevent the material from making contact with the sides of the container or if the fluid requires an agitator.

All reservoirs come standard with associated airline, fluid line, regulator, and fittings.



IJ2601N-SS-SP



IJ2601N-SS



IJ-0100



IJ-0100R



IJ-0200



IJ-0200R



IJ-0300



IJ-0300R



IJ-83Z-211



IJ-83B-500



IJ-83B-500-SP



IJ-83B-500-BK



IJ-83G-510-SP

IJ Series Reservoir Tanks

Item Number	Capacity (Gallon)	Style	Ported	Riser	Base	Tank Material	Max Pressure (psi)	Tank Outer Diameter (inches)	Material Hose O.D.
IJ2601N-SS-SP	0.5	Bottle	Top	PE	Metal	SS	50	6 1/2" x 8" O.D.	1/4"
IJ2601N-SS	0.5	Bottle	Top	SS	Metal	SS	50	6 1/2" x 8" O.D.	1/4"
IJ-0100	1	Bottle	Bottom	N/A	Metal	SS	125	9" x 12 9/16" O.D.	3/8"
IJ-0100R	1	Bottle	Top	SS	Rubber	SS	125	9" x 9 1/4" O.D.	1/4"
IJ-0200	2	Bottle	Bottom	N/A	Metal	SS	125	9" x 14 1/4" O.D.	3/8"
IJ-0200R	2	Bottle	Top	SS	Rubber	SS	125	9" x 11 5/8" O.D.	1/4"
IJ-0300	5	Bottle	Bottom	N/A	Metal	SS	125	9" x 24 15/16" O.D.	3/8"
IJ-0300R	5	Bottle	Top	SS	Rubber	SS	125	9" x 22 1/2" O.D.	1/4"
IJ-83Z-211	2.8	Top w/ Agitator	Top	SS	Metal	SS	80	13 3/8" x 23 5/8" O.D.	1/4"
IJ-83B-500	2.8	Top	Top	Galvanized Steel	Metal	Galvanized Steel	80	13 3/8" x 20 1/2" O.D.	1/4"
IJ-83B-500-SP	2.8	Top	Top	PE	Metal	Galvanized Steel	80	13 3/8" x 20 1/2" O.D.	1/4"
IJ-83B-500-BK	2.8	Top	Top	PE	Metal	Galvanized Steel	80	13 3/8" x 20 1/2" O.D.	1/4"
IJ-83G-510-SP	5	Top	Top	PE	Metal	Galvanized Steel	80	18 1/2" x 30 5/16" O.D.	1/4"

Available Accessories

Item Number	Description
560554	Material shut off valve assembly
IJ-83B-RL	Replaceable liner for IJ-83B-500, IJ-83Z-211, IJ-83B-500-SP, and IJ-83B-500-BK
PTL-408-K20	Replaceable liner for IJ-83G-510-SP
560934B-NONIJ	Regulator gauge
560779	Regulator
560944	O-ring EPDM for 1, 2, and 5 gallon bottle-style reservoirs
560944T	PTFE encapsulated Viton® O-ring for 1, 2, and 5 gallon bottle-style reservoirs

FT Series Reservoir Tanks

Designed with safety and quality in mind, Fisnar stainless steel fluid reservoir tanks maintain a steady fluid pressure for many dispensing applications.

Each model is available with a pneumatic agitation system installed with a powerful air motor for intermittent or constant fluid stirring/agitation.



FT series tanks' stainless steel construction offers high chemical resistance while preventing fluid contamination and evaporation.

Item Number	Capacity (Liters)	Style	Max Working Pressure (psi)	Weight (kg)	Body Inner & Outer Diameter (mm)	Overall Weight/Width (mm)	Height Without Lid (mm)
FT1	1	Pneumatic Standard	100	2	100/106	225/182	150
FT1-AG	1	Pneumatic Agitated	100	2	100/106	330/182	150
FT2	2	Pneumatic Standard	100	4	100/106	360/182	300
FT2-AG	2	Pneumatic Agitated	100	4	100/106	465/182	300
FT5	5	Pneumatic Standard	100	7	149/155	390/202	321
FT5-AG	5	Pneumatic Agitated	100	7	149/155	495/202	321
FT10	10	Pneumatic Standard	100	14	200/206	484/237	395
FT10-AG	10	Pneumatic Agitated	100	14	200/206	605/237	395

PP300-GL-A Clear View Pressure Chamber

A see-through pressure chamber for dispensing low viscosity liquids directly from bottles and up to 1lb (0.45kg) plastic jars.

Regulated air pressure forces the liquid in the bottle up through a disposable tube to a connector, which can be interfaced to a valve or dispensing pen.



Bottle and pen sold separately.

Features

- All wetted disposable parts
- Material visual monitoring
- Glass chamber prevents blooming or crazing when using cyanoacrylates
- Suitable for most low-viscosity fluids

Item Number

PP300-GL-A

Description

Pressure Chamber

Specifications

Interior ID	3.60" (91.44mm)
Interior Height	8.70" (220.98mm)
Max Pressure	30psi
External Dimensions	6" x 6" x 11"

Accessories

Item Number

560607

560608

560609

560610

560620

5606034

Description

Dispense Tube 0.07" I.D.

Dispense Tube 0.10" I.D.

Luer Lock Fitting 0.07" I.D.

Luer Lock Fitting 0.10" I.D.

Dip Tube

Safety Clip

DA35 Autocan Extruder System

The DA35 extrudes medium to high viscosity materials under pressure directly from a pre-filled can. This system is suitable for automatic and semi-automatic controlled dispensing applications, which require a constant supply of air-free material.

The extruder pump body is fitted with a follower plate that seals and follows the material as the level drops to wipe the sides of the can clean limiting waste. Supplied standard with 1kg follower plate or optional and interchangeable 3kg plate.



Controller, hose, valve, and handle sold separately.

Features

- Prevents air bubbles and material voids
- Air ram assist to help drive material
- Simple load mechanism provides easy cleaning
- Easy hook up for automatic systems
- Low noise electric extruder model

Accessories

Item Number	Description
EP1300LPS	Low Level Sensor
651780-A3A-B	Fluid Regulator SS 3,000psi
EP1415K	Fluid Regulator Install Kit with Gauge Fittings
DA35-1KG	Follower Plate 1kg
DA35-3KG	Follower Plate 3kg
1300060-1KG	Follower Wiper Seal NBR (117mm OD)
1300060-3KG	Follower Wiper Seal NBR (168mm OD)

Item Number	Description
DA35	Autocan Pump

Specifications

Size	8.46" x 17.32" (215 x 440mm)
Height Adjustment	21.65" min - 28.35" max (550mm min - 720mm max)
Power Input for Sensing	110-220 VAC 50-60 Hz
Air Input Pressure	30 - 100psi
Maximum Output Pressure	850psi
Fluid Viscosity Range	30,000 - 300,000cps
Ratio	8.5
Volume/Stroke	5cc
Maximum Pump Speed	60cpm
Maximum Operating Temperature	50 °C
Air Inlet/Fluid Outlet Size	1/4" NPT (f)
Wetted Parts	PTFE, Viton® and PEEK seals
Weight	12.73kg

EP1305N Pail Extruder System

The EP1305N is designed for dispensing 5 gallon pails of medium to high viscosity fluid. Ideal for silicones and grease. Systems are rated at 15:1 and provide a maximum of 996psi regulated material pressure.

The extruder pump body is fitted with a follower plate that seals and follows the material as the level drops to wipe the sides of the pail clean limiting waste. The fluid is pressure-fed by reinforced hoses to a valve that is actuated by a valve controller.

The EP1305 utilizes a low-pulse pump design suitable for automatic production dispensing applications, when used with a fluid regulator. These applications require a constant supply of air-free material. Air bubbles and material voids, caused by handling or decanting high viscosity fluids, are prevented. Supplied standard with 20kg follower plate.



Features

- Material delivered air free
- Wipe-clean action
- Air ram assist to help drive material and adjustable air ram pressure
- Electrical extruder motor
- Simple load mechanism for easy cleaning

Accessories

Item Number	Description
EP1305WP	Follower Plate for 20kg (5 gallon pail)
EP1300LPS	Low Level Sensor
651780-A3A-B	Fluid Regulator SS 3,000psi
EP1415K	Fluid Regulator Install Kit with Gauge and Fittings

Item Number

Description

EP1305N	Pump Electric 20kg (5 Gallon 15:1 220 VAC)
---------	--

Specifications

Size	19.68" x 15.74" x 47.24" 500 x 400 x 1200mm
Height Adjustment	229.72" min x 47.24" max 755mm min-1200mm max
Power Input for Sensing	220 VAC 50-60 Hz - 20 watts
Air Input Pressure	30 - 100psi
Maximum Output Pressure	996psi max
Fluid Viscosity Range	10,000 - 600,000cps
Minimum Volume/Stroke	0.01cc/shot
Max Operating Pressure	50 °C
Air Inlet/Fluid Outlet Size	1/4" NPT (f)
Wetted Parts	304 and 17-4 pH Stainless Steel, PTFE, Viton®, PEEK
Weight	52.8lbs (24kg)

EP1310C Single Cartridge Pump System

A powerful, medium-ratio system for controlled fluid transfer from 1/10th gallon (310ml) plastic cartridges. Suitable for silicone-type fluids, this low-pulse pump design can be used with a dispense valve or connected to an automatic production robot for controlled dispensing applications.

The EP1310C is designed to easily transfer material for controlled dispensing via a high pressure valve, providing a maximum of 995psi regulated material pressure. The cartridge is contained with a metal-jacketed cylinder.



Features

- Material delivered air free
- Wipe-clean action
- High-pressure regulation
- Pressure piston assist with adjustable piston pressure
- Electrical extruder motor
- Simple load mechanism for easy cleaning and easy automatic systems hook up

Item Number	Description
EP1310C	Pump Electric 1/10th Gallon

Specifications

Size	8.86" x 6.69" x 25.55" (225 x 170 x 649mm)
Pump Input for Sensing	220 VAC 50-60 Hz - 20 watts
Air Input Pressure	30-100psi
Maximum Output Pressure	995psi
Fluid Viscosity Range	10,000 - 600,000cps
Ratio	15
Minimum Volume/Stroke	0.01cc/shot
Air Consumption	80 l/min
Cartridge Size	300-310ml
Air Inlet/Fluid Outlet Size	1/4" NPT (f)
Wetted Parts	304 and 17-4 ph Stainless Steel, PTFE, Viton®, and PEEK seals
Weight	15kg

EP1320C Dual Cartridge Pump System

A powerful, medium-ratio system for controlled fluid transfer from 1/10th gallon (310ml) plastic cartridges. Suitable for silicone-type fluids. The system integrates a dual (A+B) tandem cartridge arrangement for continuous-flow management. A low-pulse pump design allows automatic control of dispensing applications. The EP1320C is designed to easily transfer material for controlled dispensing via a high pressure valve.

Rated at 15:1 the system provides a maximum of 995psi regulated material pressure. The A + B cartridge management automatically switches from either A to B or B to A when the cartridge is exhausted. Cartridges are contained in metal-jacketed cylinders.



Features

- Material delivered air-free
- Wipe-clean action
- High-pressure regulation and adjustable pressure piston assist
- Electrical extruder motor
- Easy hook up for automatic systems

Item Number

EP1320C

Description

Dual Cartridge Pump System
1/10th Gallon















Specifications

Size	10.71" x 11.34" x 25.55" (272 x 288 x 649mm)
Pump Input for Sensing	220 VAC 50-60 Hz - 20 watts
Air Input Pressure	30-100psi
Maximum Output Pressure	995psi
Fluid Viscosity Range	10,000 - 600,000cps
Minimum Volume/Stroke	0.01cc/shot
Air Consumption	80 l/min
Air Inlet/Fluid Outlet Size	1/4" NPT (f)
Wetted Parts	304 and 17-4 ph Stainless Steel, PTFE, Viton®, and PEEK seals
Weight	18kg









Standard Plastic Fittings

	Item Number	Description	Material/Color
	560714	Elbow 1/4" O.D. Tube x 1/8" NPT Male	White
	560748	Elbow 1/4" O.D. Tube x 1/4" NPT Male	White
	914	Elbow 3/8" O.D. Tube x 1/4" NPT Male	White
	560714-BLACK	Elbow 1/4" O.D. Tube x 1/8" NPT Male	Black
	560748-BLACK	Elbow 1/4" O.D. Tube x 1/4" NPT Male	Black
	560715	Straight 1/4" O.D. Tube x 1/8" NPT Male	White
	560656	Straight 1/4" O.D. Tube x 1/4" NPT Male	White
	7610	Straight 3/8" O.D. Tube x 1/8" NPT Male	White
	913	Straight 3/8" O.D. Tube x 1/4" NPT Male	White
	560715-BLACK	Straight 1/4" O.D. Tube x 1/8" NPT Male	Black
	560656-BLACK	Straight 1/4" O.D. Tube x 1/4" NPT Male	Black
	7610BP	Straight 3/8" O.D. Tube x 1/8" NPT Male	Black
	913-BLACK	Straight 3/8" O.D. Tube x 1/4" NPT Male	Black
	560657	Straight Coupling 1/4" O.D. Tube x 1/4" NPT Female	White
	560726	Straight Coupling 3/8" O.D. Tube x 1/4" NPT Female	White
	561821	Elbow Female Luer Lock x 1/8" NPT Male	Clear
	561821-BLACK	Elbow Female Luer Lock x 1/8" NPT Male	Black
	560745	Female Luer Lock Coupling	Clear
	561085	Female Luer Lock to Barb Fitting 5/32" ID x 1/4" O.D. Tube	Clear
	561086	Male Luer Lock to Barb Fitting 5/32" x 1/4" O.D. Tube	Clear

Standard Plastic Fittings

	Item Number	Description	Material/Color
	560914	Male Luer Lock x 10-32" NPT 50 UNF	Clear
	560936	Male Luer Lock x 1/4-28" NPT 50 UNF	Clear
	560733	1/4"-28 UNF Male to Female Luer Lock Connector	Clear
	560734	Reducer 1/4"-28 UNF Female x 1/4" NPT Male	Clear
	561861	Reducer 1/8" NPT Female x 1/4" NPT Male	Clear
	560950N	Reducer 1/4" - 28 UNF - 1/8" NPT Male	White
	560906N	T Fitting 5/32" I.D. x 1/4" O.D. Tube	Nylon/White
	561402N	Barbed Elbow x 1/8 NPT Male	Nylon/Natural
	561401	Barbed Fitting x 1/8 NPT Female	Nylon/Natural
	560710	Luer Lock Cap Male	Clear
	561105	Street Elbow 1/4" NPT Female x 1/4" NPT Male	P.E./Clear
	2004BA	Female Q/Connect to Barb Fitting 5/32" I.D. x 1/4" O.D.	Black
	561427H	Female Q/Connect to Barb Fitting 1/8" x 1/4" O.D.	Black
	5606035	Male Quick Connect for 0.093" I.D. Tubing	Black
	5601064	Male Quick Connect for 1/8" I.D. Tubing	Black
	560546	1/10th Gallon Cartridge Adapter	White
	561129	1/10th Gallon Cartridge Adapter	White Acetal
	5601390	Male Luer Lock x 1/4" NPT Male Adapter	White Polypropylene
	5801449	Male Luer Lock x 1/4" NPT Male Adapter	Black Polypropylene
	A-10001-OT	Male Luer Lock x M8 Male Adapter	White Polypropylene

Standard Metal Fittings

	Item Number	Description	Material/Color
	561129-SS	1/10th Gallon Cartridge Adapter	Metal
	5801420	Male Luer Lock x 1/4" NPT Male Adapter	Metal
	560953	Male Luer Lock x 1/8" NPT Male Adapter	Metal
	560716	Nipple 1/4" NPT Male	Brass
	560718	Nipple 1/8" NPT Male	Brass
	560614	Reducing Nipple 1/4" NPT Male to 1/8" NPT Male	Brass
	560719	Bushing 1/4" NPT Male x 1/8" NPT Female	Brass
	560924	Bushing 3/8" NPT Male x 1/4" NPT Female	Brass
	560717	Bushing 1/2" NPT Male x 1/4" NPT Female	Brass
	560759	Bushing 3/4" NPT Male x 1/4" NPT Female	Brass
	560727	Adapter 1/8" NPT Male x 1/4" NPT Female	Brass
	5607277SS	Adapter 1/8" NPT Male x 1/4" NPT Female	Stainless Steel
	560634	1/4" NPT Female Coupling	Brass
	560747	Elbow 1/4" NPT Male x 1/4" NPT Female	Brass
	560945	Street T 1/4" NPT Male x 1/4" NPT Female	Brass
	560757	Hex Head Plug 1/4" NPT Male	Brass
	560758	Hex Head Plug 3/8" NPT Male	Brass
	560701	Straight Barbed Fitting 1/8" I.D. Tube x 1/8" NPT Female	Brass
	560704	Straight Barbed Fitting 1/8" I.D. Tube x 1/4" NPT Male	Brass
	560737	Straight Barbed Fitting 1/4" I.D. Tube x 1/4" NPT Male	Brass
	560728	Barbed Elbow 1/8" I.D. Tube x 1/8" NPT Female	Brass
	560732	Barbed Elbow 1/8" I.D. Tube x 1/8" NPT Male	Brass
	560713	Barbed Elbow 1/8" I.D. Tube x 1/4" NPT Male	Brass
	560724	Elbow 1/4" NPT Male x 1/4" NPT Male	Brass
	560724SS	Elbow 1/4" NPT Male x 1/4" NPT Male	Stainless Steel
	560729	Elbow 1/4" NPT Male x 1/8" NPT Female	Brass

Specialty Fittings

	Item Number	Description	Material/Color
	560746A	Straight 1/4" OD Push Connector x 1/4" NPT Male	Metal
	561694	Straight 1/4" O.D. Push Connector x 1/8" NPT Male	Metal
	560762	Straight 1/4" O.D. Compression Fitting x 1/4" NPT Male	Brass
	560725	Elbow 1/4" O.D. Push Connector x 1/8" NPT Male	Metal
	561964	Elbow 1/4" O.D. Push Connector x M5 Male	Black
	5779K712	Push Connect Air Fitting (1/4" stem x 5/32" tube O.D.)	Black
	580057	Female Quick Connect x 1/4" NPT Male	Black
	51495K173	1/4" O.D. Push to Connect Air Plug	Black
	560795	T for 1/4" O.D. Tube	Metal
	560784	1/4" Push Connect Socket x 1/4" NPT Female	Metal
	560785	1/4" Plug x 1/4" NPT Male	Metal
	560703	1/4" Plug x 1/4" NPT Female	Metal
	5601062	Hose Clamp 1/4" Tube	Metal
	560779	Regulator Knob 0-100psi	Black
	560934B-NON IJ	Regulator Gauge 0-100psi	Black
	560611	Pressure Gauge 0-30psi - 1/8" NPT Top Mount	Black
	561399-NON IJ	Pressure Gauge 0-100psi - 1/8" NPT Panel Mount	Black
	561193B	Pressure Gauge 0-15psi - 1/8" NPT Panel Mount	Black
	561871B	Vacuum Gauge 0-30psi - 1/8" NPT Panel Mount	Black
	560616-50	Pressure Relief Valve 50psi Max - 1/8" NPT	Brass
	560763	Pressure Relief Valve 125psi Max - 1/4" NPT	Brass
	560949	Slide Air Valve	Brass

Tubing

Fluid tubing is available in a range of sizes, colors, and materials for a variety of dispensing requirements. Bulk roll sizes also available.

RESERVOIRS/PUMPS

	Item Number	Descriptions	Material/Color
	560722-10FT	0.250" O.D. x .188" I.D. Tubing	PTFE/Natural
	5601060-10FT	1/4" O.D. x 1/8" I.D. Tubing	PVC/Clear
	560750-10FT	3/8" O.D. x 3/16" I.D. Tubing	PVC/Clear
	560705-10FT	1/4" O.D. x 0.145" I.D. Tubing	Polyurethane/White
	561400-10FT	1/4" O.D. x 1/8" I.D. Tubing	Polyurethane/Blue
	5606030-100FT	0.152" O.D. x 0.093" I.D. Tubing	Polyurethane/Clear
	561415-IJ-10FT	1/4" O.D. x 0.170" I.D. Tubing	Polyethylene/Natural
	561416-10FT	3/8" O.D. x 1/4" I.D. Tubing	Polyethylene/Natural
	560743-10FT	1/4" O.D. x 0.170" I.D. Tubing	Polyethylene/Black
	560744-10FT	3/8" O.D. x 1/4" I.D. Tubing	Polyethylene/Black
	562066-10FT	6mm O.D. x 4mm I.D. Tubing	Polyethylene/Natural

Air Manifolds

Air manifolds provide the capacity of connecting up to four valves to one dispenser.

Item Number	Description
560057	4 Port Air Manifold (1/4" Tube)
51495K173	1/4" OD Push to Connect Air Plug



Fluid Manifolds

Fluid manifolds provide the capability of supplying material from one reservoir to up to four valves. Suitable for 1/4" or 3/8" tubing.

Item Number	Description
560542-1/4	4 Port Fluid Manifold (1/4" Tube)
560542-3/8	4 Port Fluid Manifold (3/8" Tube)
EA4P	Threaded Square Plug PE



Mufflers for Bechtop Controllers

Mufflers filter air output up to 0.5 microns and provide muffling of exhaust air where reduced operating noise is required.

Models

Item Number	Description
560024	Clean Room Filter Muffler (1/4" O.D.)
560024DC	Clean Room Muffler for DC Controllers (10-32 UNF)



Air Filters

Models

Item Number	Description
560567	5 Micron Air Filter





Robotics



F5200N.1 3-Axis Inline Gantry Robot

The model F5200N.1 is a compact and versatile gantry robot with all moving axes above the work piece. The Unitop™ design is suitable for applications requiring a mount that provides open access under the robot.

This robot is ideal for conveyor-fed automation or installed in work cells, operating as a stationary robot. When higher workloads or part size prevent using standard benchtop robots, the F5200N.1 can meet these demands.

Programming is simply carried out by a teach pendant (included) using the industry's leading dispensing software that walks the user through step-by-step instructions to create a sophisticated dispensing operation in minutes.



Features

- Gantry-style design allowing for flexible operation
- Separate control box for reduced footprint
- Z-axis reach allows for larger applications
- Tip alignment routine for quick program offsets
- Durable linear belt drive for industrial environments
- In-line capability for increased throughput
- Step and repeat functionality

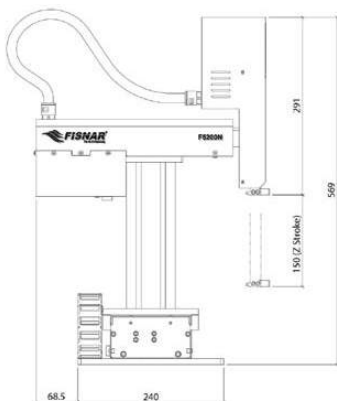

Item Number	Description
-------------	-------------

F5200N.1	3-Axis Inline Gantry Robot
----------	----------------------------

Specifications

Item Number	F5200N.1
Working Area X/Y/Z (mm)	200 x 200 x 150mm
Maximum Speed (X&Y/Z)	500 / 320mm / secs
Tool Load-Z-Axis	2kg
Repeatability	+/- 0.02mm / axis
Resolution	0.001mm / axis
Motion Control	PTP & CP
Drive System	Micro stepping motors
Data Memory	1-100 programs 50,000 points/program
I/O Signals	8 inputs / 8 outputs
External Interface	USB / RS232
Power Supply	Auto-switching AC 100-240 VAC, 320 watts
Dimensions (W/D/H)	485 x 383.5 x 569mm
Weight	25kg

F4200N.1 Compact Benchtop Robot

The F4200N.1 is a compact and ergonomically designed benchtop robot created to support most general dispensing applications requiring a high performance standard and consistent repeatable results.

Programming the F4200N.1 is simple with the included teach pendant and optional tip alignment.

Using the industry's market-leading software, the teach pendant provides users with step-by-step instructions resulting in a sophisticated dispensing operation in minutes.



Features

- Repeatability 0.02mm
- Small footprint for bench space reduction
- Step and repeat functionality
- USB port for data transfer and back up
- Optional PC programming

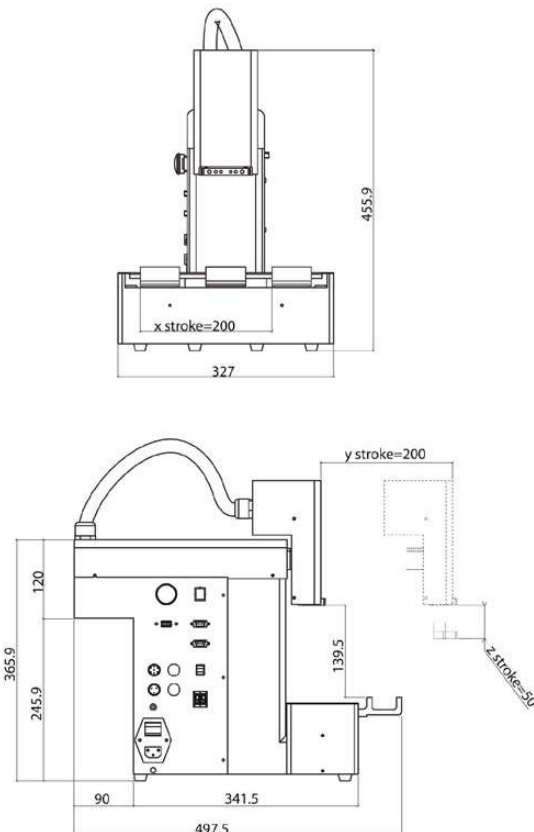

Item Number	Description
-------------	-------------

F4200N.1	Compact Benchtop Robot
----------	------------------------

Specifications

Item Number	F4200N.1
Working Area X/Y/Z (mm)	200 x 200 x 50mm
Maximum Speed (X&Y/Z)	500 / 200mm / secs
Work Load	3kg
Tool Load-Z-Axis	2kg
Repeatability	+/- 0.02mm / axis
Resolution	0.001mm / axis
Motion Control	PTP & CP
Drive System	Micro stepping motors
Data Memory	1-100 programs 50,000 points/program
I/O Signals	8 inputs / 8 outputs
External Interface	USB / RS232
Power Supply	Auto-switching AC 100-240 VAC, 320 watts
Dimensions (W/D/H)	324 x 500 x 465mm
Weight	20kg

F4000 Advance Series 3-Axis Robot

Fisnar F4000 Advance 3-axis benchtop robots are designed to ensure precise fluid placement and positioning. When configured with a syringe, cartridge, or valve system, a high level of accuracy and repeatability is achieved. Specifically built for fluid dispensing processes, the F4000 proprietary robot software is user friendly and enables the creation of complex dispensing routines (dots, lines, circles, arcs, and fills) that can be set up and operational in just minutes using the teach pendant (included).

The proprietary windows programming software allows for DXF files to be imported into the software and have dispense lines or dots quickly created from the imported CAD data. This feature dramatically reduces programming time for complex dispense patterns or when there is a high number of dispense positions.

The F4000 Advance can be supplied individually or as a complete stand-alone machine system by integrating into a safety enclosure.*

**Required to conform to European CE safety regulations (Machinery Directive 2006/42/EC).*



Models

Item Number	Description
F4303	3-Axis Robot - 300x300x100mm Work Area
F4403	3-Axis Robot - 400x400x100mm Work Area
F4503	3-Axis Robot - 500x500x150mm Work Area
F4603	3-Axis Robot - 600x500x150mm Work Area

Features

- Modular connectivity for easy installation of accessories at any time such as the CCD vision kit, tip-alignment, or height sensor
- USB Port for data transfer and back-up
- Program selector switch and fluid purge button
- True 3D interpolation and simultaneous motion control
- Teach pendant included for easy programming

Benefits

- High positional accuracy improves dispense results
- Proprietary user-friendly software allows programs to be easily and quickly set up using the teach pendant or PC
- Increased productivity due to faster cycle times and less rejects
- Windows software provides greater control and visibility of complete dispense program

F4000 Series 3-Axis Robots

Specifications

Item Number	F4303	F4403	F4503	F4603
Maximum Working Area X/Y/Z	300 x 300 x 100mm (12 / 12 / 4")	400 x 400 x 100mm (16 / 16 / 4")	500 x 500 x 150mm (20 / 20 / 6")	600 x 500 x 150mm (24 / 20 / 6")
Maximum Speed (X&Y/Z)	800 / 320mm / secs (31 / 13" / secs)			
Work Load	10kg (22lb)			
Tool Load	5kg (11lb)			
Repeatability	+/- 0.008mm**			
Motion Control	PTP & CP			
Drive System	3-phase micro stepping motors			
Data Memory	1-100 programs 1-50,000 points / program			
I/O Signals	8 inputs / 8 outputs			
External Interface	USB / RS232			
Power Supply	Auto-switching AC 100 - 240 VAC, 320 watts			
Dimensions (W/D/H)	490 x 645 x 517mm (19 x 25 x 20")	590 x 645 x 617mm (23 x 25 x 24")	690 x 815 x 717mm (27 x 32 x 28")	810 x 815 x 717mm (32 x 32 x 28")
Weight	21kg (46lb)	39.5kg (87lb)	44.5kg (98lb)	47kg (104lb)
Approvals	CE, RoHS, WEE			

**Repeatability value will vary depending on measurement method.

F4303

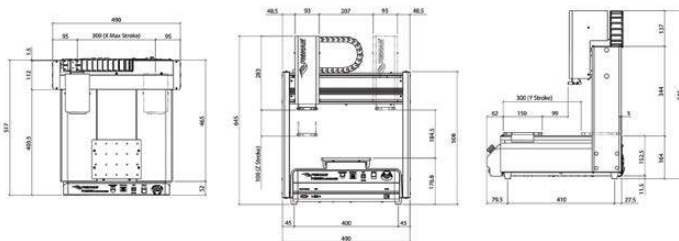

F4503

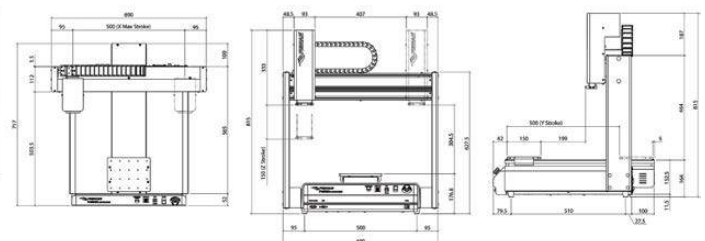

F4403

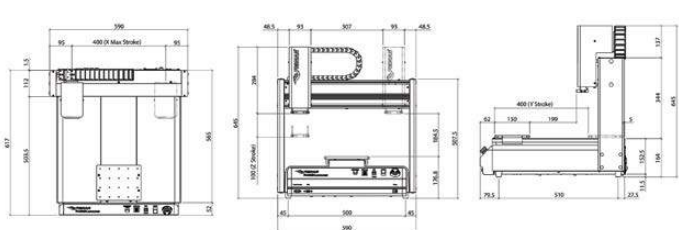

F4603

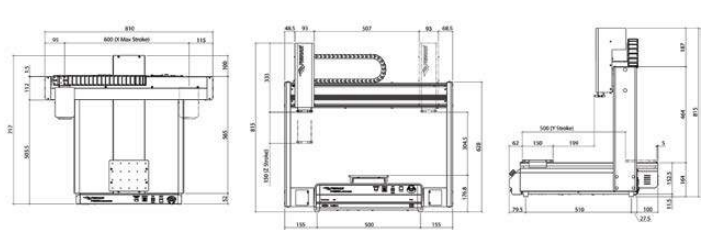

F4000 Advance Series 4-Axis Robot

Fisnar F4000 Advance series 4-axis benchtop robots are designed to ensure precise fluid placement and positioning.

Specifically made for fluid dispensing processes, the F4000 proprietary robot software is user friendly and enables the creation of complex dispensing routines (dots, lines, circles, arcs, and fills) that can be set up and operational in just minutes using the teach pendant (included).

The additional 4th rotational (R) axis allows for dispensing at a user-specified, fixed angle around the 360° rotational plane, allowing it to access hard-to-reach areas and vertical surfaces.

The F4000 Advance can be supplied individually or as a complete stand-alone machine system by integrating into a safety enclosure.*

**Required to conform to European CE safety regulations (Machinery Directive 2006/42/EC).*



Models

Item Number	Description
F4304	4-Axis Robot - 300x300x150mm Work Area
F4404	4-Axis Robot - 400x400x150mm Work Area
F4504	4-Axis Robot - 500x500x150mm Work Area
F4604	4-Axis Robot - 600x500x150mm Work Area

Features

- Integral tip position adjustment routine
- USB port for data transfer and back-up
- Program selector switch and fluid purge button
- True 3D interpolation and simultaneous motion control
- Modular connectivity design for the simple installation of productivity enhancement tools

Benefits

- High positional accuracy improves dispense results
- Proprietary user-friendly software allows programs to be easily and quickly set up using the teach pendant
- Increased productivity due to faster cycle times and less rejects

F4000 Series 4-Axis Robots

Specifications

Item Number	F4304	F4404	F4504	F4604
Maximum Working Area X/Y/Z	300 x 300 x 150mm (12 / 12 / 6")	400 x 400 x 150mm (16 / 16 / 6")	500 x 500 x 150mm (20 / 20 / 6")	600 x 500 x 150mm (24 / 20 / 6")
Max Working Area (R)	+/- 720°			
Maximum Speed (X&Y/Z)	800 / 320mm / secs (31 / 13" / secs)			
Maximum Speed (R)	720° / secs			
Work Load	10kg (22lb)			
Tool Load	5kg (11lb)			
Repeatability	+/- 0.008mm**			
Motion Control	PTP & CP			
Drive System	3-phase micro stepping motors			
Data Memory	1-100 programs 1-50,000 points / program			
I/O Signals	8 inputs / 8 outputs			
External Interface	USB / RS232			
Power Supply	Auto-switching AC 100 - 240 VAC, 320 watts			
Dimensions (W/D/H)	540 x 914 x 552mm (21 x 36 x 22")	640 x 914 x 652mm (25 x 36 x 30")	740 x 914 x 752mm (29 x 36 x 30")	860 x 914 x 752mm (32 x 36 x 30")
Weight	41kg (90lb)	46kg (101lb)	48 kg (106lb)	52 kg (115lb)
Approvals	CE, RoHS, WEE			

**Repeatability value will vary depending on measurement method.

F4304

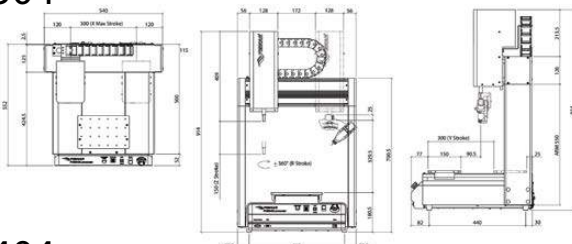

F4504

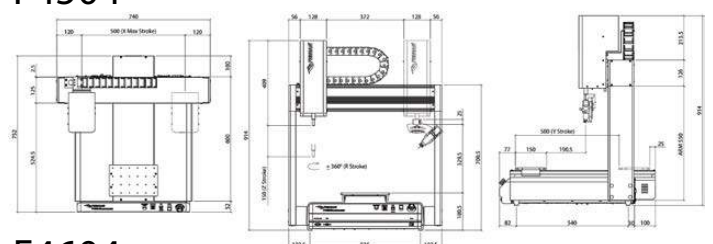

F4404

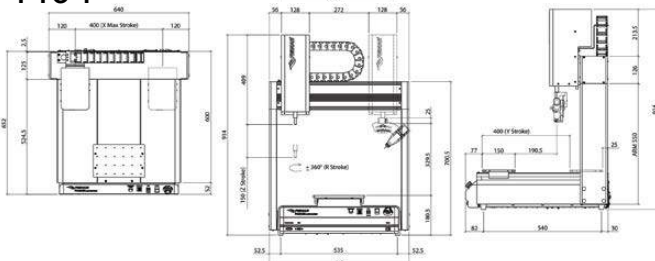

F4604

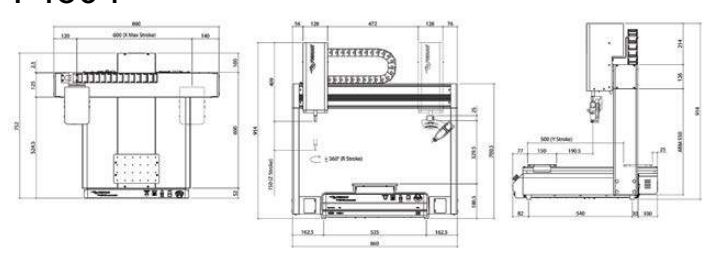

F4000 Advance 5-Axis Robot

Fisnar F4000 Advance 5-axis benchtop robot provides both a rotational vertical (B) axis and horizontal (U) axis for applying adhesives and sealants on curved, vertical, or difficult to reach applications.

The F4000 proprietary robot software is user friendly and enables the creation of complex dispensing routines (dots, lines, circles, arcs, and fills) that can be set up and operational in just minutes.

The 5-axis simultaneous positioning is also ideal for dispensing around ledges, lips, and inside channels with form-in-place gasketing materials or staking / ruggedizing electrical components on a PCB with a silicone RTV material. The F4000 Advance can be supplied individually or as a complete stand-alone machine system by integrating into a safety enclosure.*

**Required to conform to European CE safety regulations (Machinery Directive 2006/42/EC).*



Features

- Integral tip position adjustment routine
- USB port for data transfer and back-up
- Program selector switch and fluid purge button
- True 3D interpolation and simultaneous motion control
- Modular connectivity design for the simple installation of productivity enhancement tools

Item Number	Description
F4505	5-Axis Robot - 500x500x150mm Work Area

Benefits

- High positional accuracy improves dispense results
- Proprietary user-friendly robot software allows programs to be easily and quickly set up using the teach pendant or PC
- Increased productivity due to faster cycle times and less rejects

F4000 Series 5-Axis Robots

Specifications

Item Number	F4505
Maximum Working Area X/Y/Z	500 x 500 x 150mm (20 / 20 / 6")
Max Working Area (R)	+/- 720°
Maximum Speed (X&Y/Z)	800 / 320mm / secs (31 / 13" / secs)
Maximum Speed (R)	720° / secs
Work Load	10kg (22lb)
Tool Load	1kg (2.2lb)
Repeatability	+/- 0.008mm**
Motion Control	PTP & CP
Drive System	3-phase micro stepping motors
Data Memory	1-99 programs 1-50,000 points / program
I/O Signals	8 inputs / 8 outputs
External Interface	USB / RS232
Power Supply	Auto-switching AC 100 - 240 VAC, 320 watts
Dimensions (W/D/H)	740 x 914 x 752mm (29 x 36 x 30")
Weight	48 kg (106lb)
Approvals	CE, RoHS, WEE

**Repeatability value will vary depending on measurement method.

F4505

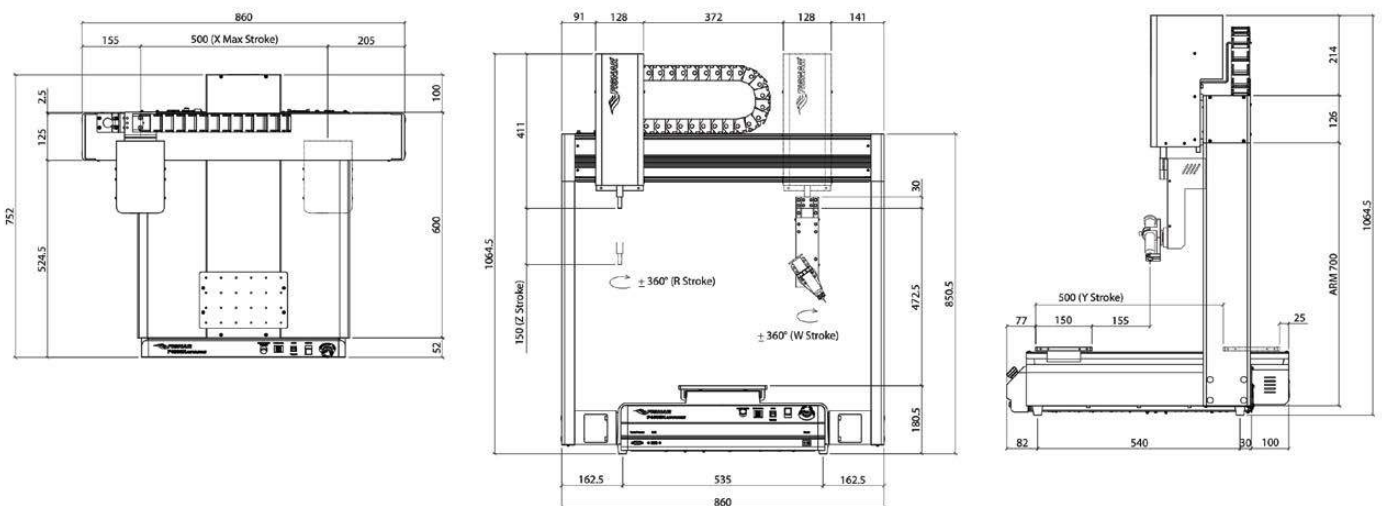

F4000 Advance Series Dual Table Robot

F4000 Advance dual table benchtop robots are designed to ensure precise fluid placement and positioning.

The unique dual-table design allows for high speed manufacturing due to the elimination of part changeover and loading time. This is made possible with the removal of finished parts and the loading of new parts on the fixture of one table, while the other table is being processed by the robot.

Furthermore, the dual-table design provides users the option to carry out two different dispensing routines sequentially, thus eliminating the requirement for batch production.

The F4000 Advance can be supplied individually or as a complete stand-alone machine system by integrating into a safety enclosure.*

**Required to conform to European CE safety regulations (Machinery Directive 2006/42/EC).*



Models

Item Number	Description
F4553	3-Axis Robot - 500x500x100mm Work Area
F4554	4-Axis Robot - 500x500x150mm Work Area

Features

- Unique dual-table design for high speed manufacturing
- USB port for data transfer and back-up
- Program selector switch and fluid purge button
- True 3D interpolation and simultaneous motion control
- Modular connectivity feature

Benefits

- Dual-table design increases production rates
- Independent control of each table
- High positional accuracy improves dispense results
- Proprietary user-friendly robot software allows programs to be easily and quickly set up using the teach pendant
- Increased productivity due to faster cycle times and less rejects

F4000 Advance Series Dual Table Robot

Specifications

Item Number	F4553	F4554
Maximum Working Area X/Y/Z	500 x 500 x 100mm (20 / 20 / 4")	500 x 500 x 150mm (20 / 20 / 6")
Maximum Working Area (R)	+/- 720°	
Maximum Speed (X&Y/Z)	800 / 320mm / secs (31 / 13" / secs)	
Maximum Speed (R)	720° / secs	
Work Load	10kg (22lb)	
Tool Load	5kg (11lb)	
Repeatability	+/- 0.008mm**	
Motion Control	PTP & CP	
Drive System	3-phase micro stepping motors	
Data Memory	1-100 programs 1-50,000 points / program	
I/O Signals	8 inputs / 8 outputs	
External Interface	USB / RS232	
Power Supply	Auto-switching AC 100 - 240 VAC, 320 watts	
Dimensions: (W/D/H)	740 x 659 x 717mm (30 x 26 x 28")	740 x 916 x 717mm (30 x 36 x 28")
Weight	52kg (115lb)	56kg (123lb)
Approvals	CE, RoHS, WEE	

**Repeatability value will vary depending on measurement method.

F4553

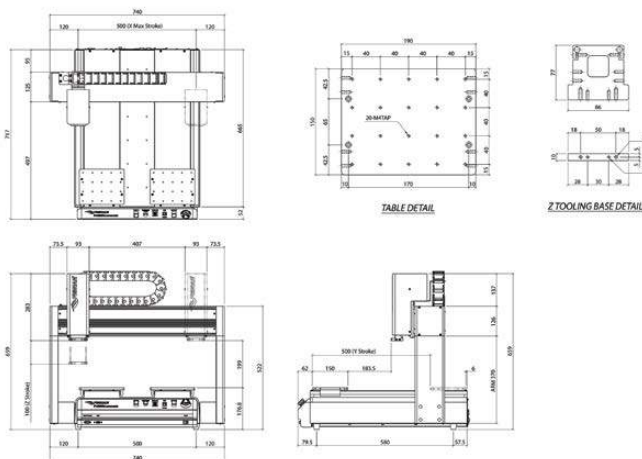

F4554

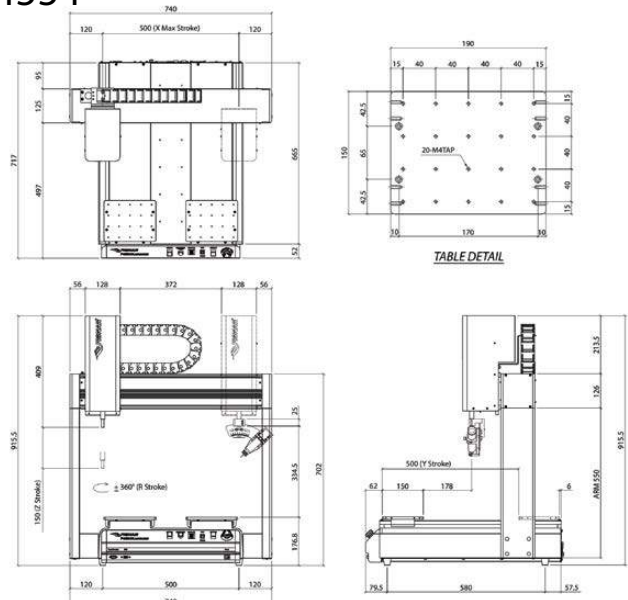

F8000N Series Cantilever Industrial Robots

The F8000N series of robots are servo motor-driven, ball screw design, cantilever robots. A heavy duty aluminum structure prevents flexing and vibration while maintaining functionality. Ideal for conveyor-fed applications.

Where applications require all moving axes to be above the workstation, the F8000N series provides the capability.

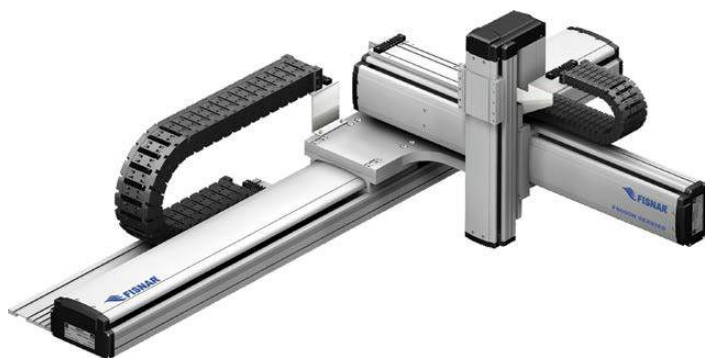

Custom robot sizes available upon request.

Features

- AC servo motors
- Available in three and four axis models
- Repeatability of 0.02mm
- Highly rigid frame structure
- Open access design for in-line operation
- 100 programs on board

Models

Item Number	Description
F8100N	3-axis Robot - 1,000x800x200mm Work Area
F8104N	4-axis Robot - 1,000x800x200mm Work Area
F8800N	3-axis Robot - 800x600x200mm Work Area
F8804N	4-axis Robot - 800x600x200mm Work Area

Specifications

Item Number	F8100N Series	F8800N Series
Working Area X/Y/Z	1,000 x 800 x 200mm (+/- 360°)	800 x 600 x 200mm (+/- 360°)
Maximum Tool Load (R)	5kg (11lb)	
Maximum Speed X&Y/Z	1000 & 500mm / secs (360°)	
Repeatability (R)	+/- 0.02mm/axis (+/- 0.058 ³)	
Resolution (R)	0.001mm (+/- 0.001°)	
Data Memory	100 programs / 20,000 steps / 20,000 points	
Drive System	AC servo motor	
Motion Control	PTP & CP	
System I/O, User I/O	24 inputs / 6 outputs, 32 inputs / 6 outputs	
Dimensions (W/D/H)	1425 x 1630 x 627mm (56.1 x 64.17 x 24.72")	1110 x 1380 x 565mm (43.7 x 54.33 x 22.24")
Weight	F8100N: 15kg, F8401N: 124kg (F8100N: 254lb, F8401N: 273lb)	F8800N: 72kg, F8804N: 81kg (F8800N: 159lb, F8804N: 179lb)

F9000N Series Gantry Industrial Robots

The F9000N gantry-cartesian robotic systems can be easily integrated with in-line industrial automation.

Gantry industrial robots have all their axes above the work area making them ideal for large dispensing applications and jobs requiring a fourth axis, such as when using a spray valve.

These robots can be manufactured to accommodate custom sizes up to 8m x 6m.



Custom robot sizes available upon request.

Features

- AC servo motors
- Available in three and four axis models
- Repeatability of 0.02mm
- Highly rigid frame structure
- Open access design for in-line operation
- 100 programs on board

Models

Item Number	Description
F9300N	3-axis Robot - 300x300x200mm Work Area
F9304N	4-axis Robot - 300x300x200mm Work Area
F9600N	3-axis Robot - 600x600x200mm Work Area
F9604N	4-axis Robot - 600x600x200mm Work Area
F9800N	3-axis Robot - 800x600x200mm Work Area
F9804N	4-axis Robot - 800x600x200mm Work Area

Specifications

Item Number	F9300N Series	F9600N Series	F9800N Series
Working Area X/Y/Z	300 x 300 x 200mm (+/- 360°)	600 x 600 x 200mm (+/- 360°)	800 x 600 x 200mm (+/- 360°)
Maximum Speed X&Y/Z (R)	1,000 & 500mm / secs (360°/secs)		
Maximum Tool Load (R)	7kg (1kg)		
Resolution (R)	0.001mm (+/- 0.001°)		
Data Memory	100 programs / 20,000 steps / 20,000 points		
System I/O, User I/O	24 inputs / 6 outputs, 32 inputs / 32 outputs		
External Interface	USB / RS232		
Power Supply	100 - 240 VAC		
Dimensions (W/D/H)	679 x 696 x 505mm (26.73 x 27.40 x 19.88")	979 x 1022 x 505mm (38.54 x 40.24 x 19.88")	1179 x 1022 x 505mm (46.4 x 40.24 x 19.88")
Weight	28.94kg (64lb)	36.92kg (81lb)	42.9kg (94.5lb)

F2004N 4-Axis SCARA Robot

F2004N is a 4-axis high-speed, industrial SCARA robot. SCARA is an acronym for Selective Compliance Assembly Robot Arm. Designed to be used with conveyors and work cells, it is ideal for high volume and large area dispensing applications requiring greater flexibility for automated manufacturing environments.

The F2004N dispensing robot can also be used for pick and place applications.



Features

- Highly rigid frame structure
- Positioning repeatability 0.020mm
- Performs continuous path and point-to-point motions
- Software tip alignment routine for quick program offsets when changing dispensing tips
- Digital servo controlled motors
- Multiple I/O communications
- High speed movement up to 5,000mm/s

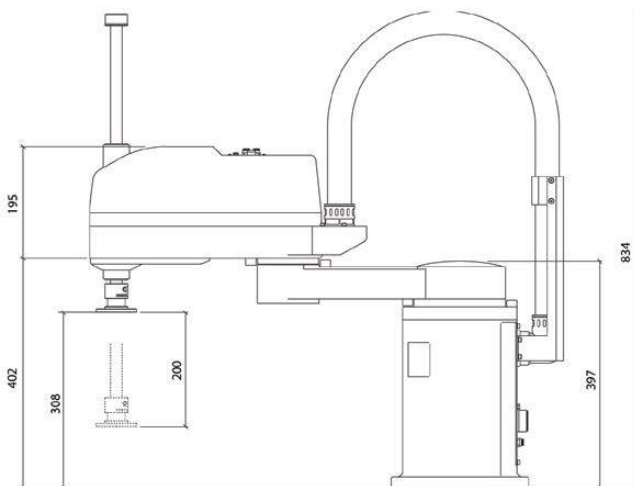
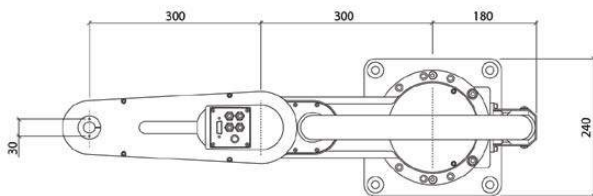

Item Number	Description
-------------	-------------

F2004N	4-axis SCARA Robot
--------	--------------------

Specifications

Item Number	F2004N
Rated/Max Payload (J1 & J2 arm)	2 / 7kg
Arm Length	300 x 300mm
Repeatability (J1 & J2 arm, J3, J4)	+/- 0.03, +/- 0.02, +/- 0.03mm
Operation Range	+/- 125°, +/- 125°, 200 mm, +/- 360°
Maximum Speed	5.6 m/s, 1 m/s, 720°/secs
Allowable J4 Inertia	0.003 kgfm.s2
Data Memory Capacity	100 programs, 1,000 points / program
Drive System	Full digital AC Servo
Motion Control	PTP & CP
Interpolation	All axes
I/O Signals	24 inputs / 6 outputs, 32 inputs / 32 outputs
External Interface	RS232
Working Temperature	0 - 40 °C
Relative Humidity	20 - 90%
Dimensions (WxDxH)	240 x 828 x 834mm
Manipulator Weight	37kg
Controller Weight	10kg

F1300N Rotary Table

The F1300N rotary table provides an efficient method of dispensing a circular pattern on areas that are difficult to access. The tilting Z-axis allows controlled rotary dispensing on a fixed angle.

Used for dispensing adhesives, silicones, grease, and lubricants, the F1300N is fully adjustable in rotation speed, circle diameter and dispensing time. Dispense from barrels, cartridges or valves mounted on the Z-axis.

The Z-axis tilt is easily adjusted to dispense either on a vertical wall within a cylindrical part or on an outside wall. The system is fully programmable to control dispense delay, degree of rotation, and wait period before cycling.

Features

- Touch screen LCD display for easy set up and operation
- Fully programmable for accurate dispensing
- 9 user programmable memories
- Password-protected operator lock-out mode
- I/O interface

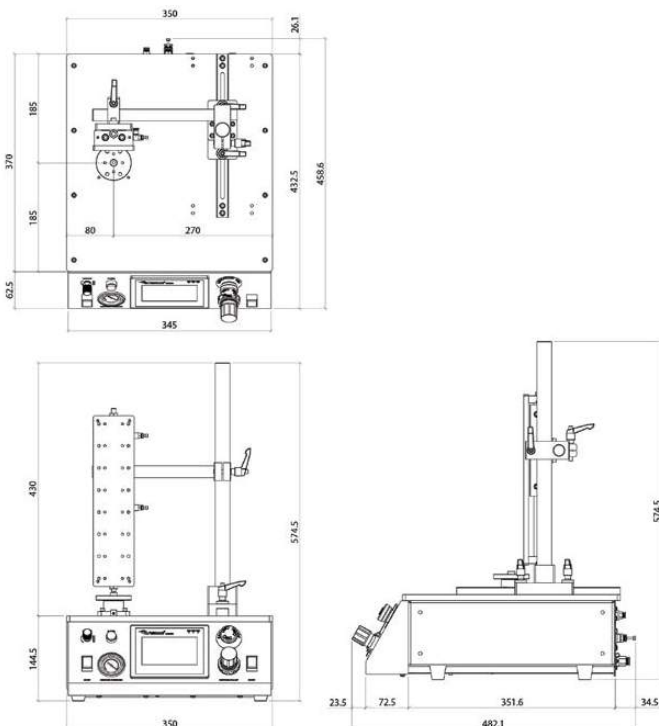

Item Number	Description
F1300N	Rotary Table

Specifications

Item Number	F1300N
Cycle Initiation	Manual or automatic
Vertical Travel	50mm (2.00") other lengths optional
Rotation Speed	0-60rpm
Air Input	70-100psi (5-7bar)
Air Output	1-100psi (5-7 bar)
Dimensions (W/D/H)	635 x 642 x 850mm
Work Load	2kg
Tool Load	10kg
Working Area (Diameter)	12" (300mm)
Weight	20kg

Mechanical Tip Alignment

The TA360U-KIT is a mechanical tip adjustment kit allowing the mounting hardware attached to the robot to be mechanically adjusted in the X Y & Z axis.

The TA360U-KIT allows the dispense tip to be quickly and easily adjusted by re-aligning it to a known location of the robot program.

Re-alignment can be carried out remotely to the program and adjustments can be easily made by users not trained in robot programming.



Item Number

TA360U-KIT

Automatic Tip Alignment

A series of tip alignment modules designed for precise dispensing applications that require frequent material or tip changes, which could alter the position of the dispensing needle.

With the tip alignment module installed, the user can simply run a function on the robot that will automatically offset the program based on the new dispense tip position. This ensures consistent dispense results and minimal production downtime.

This functionality can also be run through an external control making it simple for use in a production environment.



Models

Item Number	Description
F4000AKIT-TA3	Tip Alignment Module for F4000 ADVANCE 3-Axis Robots
F4000AKIT-TA4	Tip Alignment Module for F4000 ADVANCE 4-Axis Robots
TA9000N	Tip Alignment Module for F8000 & F9000 3-Axis Robots
TA4200N	Tip Alignment Module for F4200N.1 & F5200N.1 Robots

Height Sensor

The height sensor automatically adjusts the dispense tip height in the event of any variation of the height of workpiece being dispensed upon. Setup and programming of the height sensor is carried out by following a user friendly step-by-step procedure pre-installed onto the robot software.

By comparing the actual workpiece height against the original stored datum value in the robot program, any deviation found in the workpiece height results in the Z-axis coordinate data being automatically offset accordingly. Multiple height checks can be made within one robot program in the event of multiple workpieces being processed or a single workpiece with differing heights.



Item Number

F4000AKIT-HDS

CCD Camera Vision System

A powerful and intelligent CCD vision programming and auto adjustment system for creating both simple and complex dispense routines. This results in improved quality due to precise dispense positioning alongside improved production yield and reduced processing time and costs.

Dispense programs are created quickly and easily in the Fisnar proprietary vision-controlled Fluid-In-Motion (FIM) software by using the displayed camera image to jog the robot to the exact required dispense location, and then selecting the operation wished to be carried out (dispense dot, line start etc).

Vision System software is supplied with an auto-part alignment function to guarantee fluid is being dispensed at the exact required location. This is achieved by the system capturing an image of two separate fiducial locations on the component and using pattern recognition software to compare the live image against a stored image. Any difference found in X or Y position results in the dispense coordinates being automatically adjusted to suit.

Dispense positional accuracy and repeatability is further optimised by the simple auto-calibration routine and part alignment function.

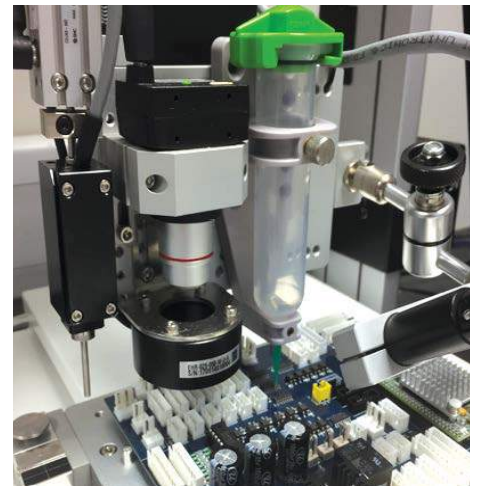

Item Number

F4000AKIT-VISION

Features

- Auto 3-axis tip calibration function
- Auxillary camera to monitor dispense process live
- High resolution CCD camera
- LED Light & Brightness Controller
- Simple & fast transfer of CAD data (.DXF/Gerber) into software
- Quick to set up and easy to program/operate using proprietary
- Industrial windows based PC system included
- Glue Check/Verification function*

Benefits

- Vision system can be easily installed at any time onto a F4000
- ADVANCE 3-axis robot using plug and play system design
- Peripheral hardware is mounted directly onto robot reducing space envelope taken up
- Images can be captured and stored for quality and process control purposes
- QR codes can be scanned by the camera, causing the relating program to be automatically selected

ROBOTICS

Proprietary User Interface

For simple user setup, programming and operation.

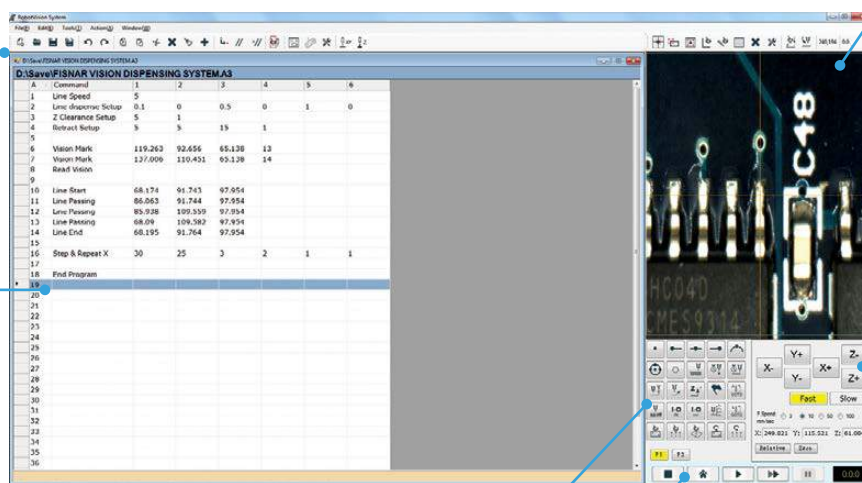

Tool Ribbon
Used for quickly accessing program setup and management functions.

Programming Window
Gives full and simple view of complete dispense program. Values can be edited directly by clicking on the line.

Camera Display
Real time view of camera viewing area. Cross hair designates dispense location to ensure precise positional control. Clicking on imaging area will jog robot to position clicked on.

Robot Movement
Icons used to control robot movement and speed while also displaying absolute/relative dispense coordinates.

Dispense Function
Graphical icons used for quick robot programming.

Robot Actuation
Icons used to start, stop and view robot program.

*Glue check function not suitable for all applications. To be certified by Fisnar application team.



1 F4000 ADVANCE Desktop Robot

Highly robust and durable based on their cast aluminium base and heavy duty extruded aluminium twin vertical side pillars supporting the horizontal X-axis. This rigid design concept allows for long term precision dispensing and dependable repeatability.

2 PC

Industrial specification PC installed with Windows 7 and supplied installed with Fluid-In-Motion (FIM) software ready to use. Unit mounted directly onto robot to reduce overall space envelope. TFT LCD monitor, keyboard & mouse included.

3 CCD Camera

For high resolution color and greyscale image capturing.

4 LED Ring Light & Controller

For optimising image contrast and definition. Adjustable light brightness controller is mounted directly onto the robot to reduce the overall space envelope.

5 Tip Calibration Module

Works by the camera capturing an image of the purged fluid and uses pattern recognition to compare it against a pre-defined datum image. Any difference found between the center positions result in the X and Y coordinate values being automatically adjusted and dispense program re-aligning to suit. The Z-axis is automatically calibrated by the dispense tip contacting a touch pad.

6 Aux Camera

Displays a live image on the TFT LCD monitor allowing the user to clearly monitor the fluid being dispensed onto the component part while a dispense cycle is taking place.

Auxiliary Rotation Axis

The Auxiliary rotation module allows an additional axis to be quickly and easily mounted onto a F4000 ADVANCE 3-Axis robot. The device can be mounted in two different ways:

Horizontal Mounting: When 4-Axis (R) rotation is required, but is not possible due to the size or weight of the dispense equipment that is normally attached to the robot Z-Axis that would typically rotate on a conventional 4-Axis robot. This configuration set-up results in the workpiece rotating instead, achieving the same end dispense result. Horizontal mounting also allows the CCD vision system to be used in application processes requiring 4-axis motion.

Vertical Mounting: In applications that require dispensing onto multiple planes on a single workpiece.

Dispensing onto cylindrical components can be made easy with the device mounted in either a horizontal or vertical position depending on the specific application process.



Item Number

F4000AKIT-AUX

I/O Expansion Module

The I/O Expansion module increases the number of inputs and outputs while simplifying connection of external devices (e.g. sensors) to the robot.

The I/O expansion module increases the number of robot inputs to 16 channels and outputs to 20 channels. Two different models (NPN or PNP) are available depending on the I/O signal type of the external devices. The use of this device also prevents any damage caused to the PCB's inside the robot due to incorrect wiring or failure of the external device.



Item Number	Description
F4000AKIT-IONPN	I/O Expansion Module - NPN Signal
F4000AKIT-IOPNP	I/O Expansion Module - PNP Signal

Remote Operation Box

The remote operation box allows users to operate the robot from a safe distance or in instances when the robot is housed within a safety enclosure.

A version is also available with a safety relay (Category 3, PL d) incorporated directly inside allowing a light curtain or safety switch to be easily connected to the control box. This eliminates the need for additional cost for an unnecessary electrical control panel to be fitted.



Item Number	Description
F4000AKIT-EXTBOX	Remote Operation Box
F4000AKIT-EXTBOX-SR	Remote Operation Box with Safety Relay

N.1 Robot Upgrade Kit

The upgrade kit can be installed onto a Fisnar F4300N.1, F4400N.1 or F4500N.1 robot, making it compatible with the following robot accessory kits: CCD Camera Vision System, Automatic Tip alignment, Height Sensor, I/O Expansion Module, Remote Operation Box.



Item Number	Description
F4000AKIT-N.1ADV-3	Upgrade Kit for F4300N.1
F4000AKIT-N.1ADV-4	Upgrade Kit for F4400N.1
F4000AKIT-N.1ADV-5	Upgrade Kit for F4500N.1

Universal Robot Holder Assemblies

High quality valve and cartridge holder assemblies for use with Fisnar's line of robots and dispense systems.

Kitted for easy out of the box plug and play assembly, designed to create a smoother and convenient installation, removal, and setup experience.

Their unique design allows for valves to be quickly removed for maintenance requirements and then re-installed without losing the original datum mounting position.

The Z-axis mounting position can also be adjusted to reduce working movement to the workplace in order to reduce robot cycle times.

Suitable for use with the following platforms:

- F4000 Series Benchtop (3, 4, and 5-axis)
- F5000 Series Benchtop (3-axis)
- F8000 Series Gantry (3-axis)
- F9000 Series Gantry (3-axis)
- F1300 Rotary Table

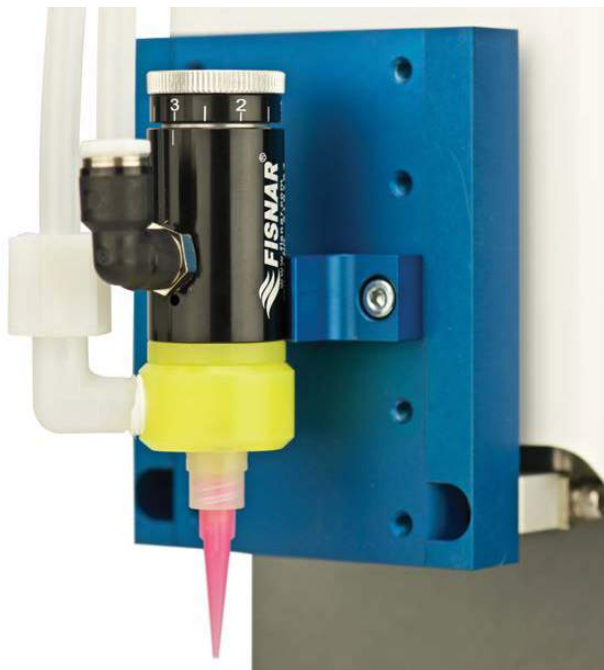

Universal Syringe, Valve & Cartridge Retainer Holders



560920U Universal Syringe Holder
For use with 3, 5, 10, 30, and 55cc syringes

562151U Universal Valve Holder
For use with VP300, VD510, and SV2000N

562088U Valve Holder
For use with SV1000SS

5601801U Universal Valve Holder
For use with VMP30H, PDV-1000, VMS400, and VDP150

5601800U DTD50 Holder
For use with DTD50 2K Applicator and TS5000DMP

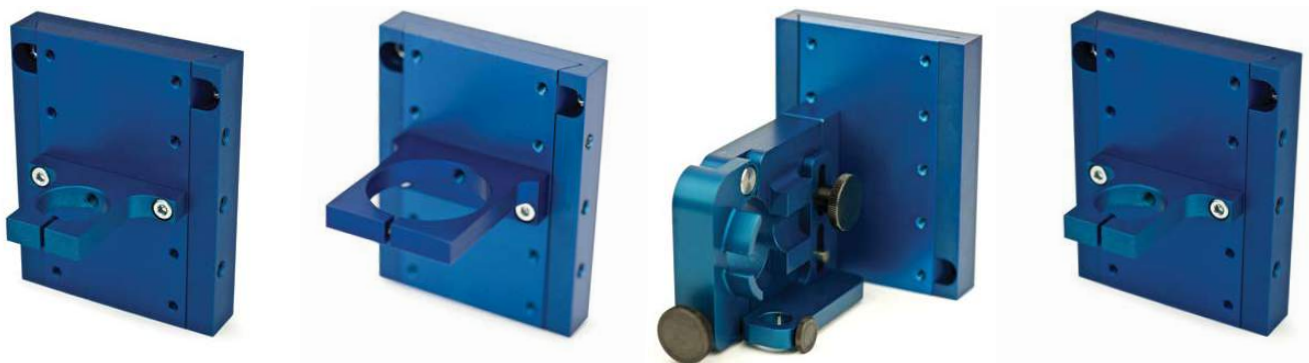

560928U Universal Valve Holder
For use with MV-0180LF

560927U Universal Valve Holder
For use with 790HP-LF

561355U Universal Valve Holder
For use with 710PT-LF

562064U Universal Valve Holder
For use with CV629



560926-EU E-type Cartridge Retainer Holder

560926-TU Cartridge Retainer Holder T-type

561785U 1/10th Gallon Retainer Holder

562297-EU 20oz Cartridge Retainer Holder E-type

562297-TU 20oz Cartridge Retainer Holder T-type

Modular Syringe & Valve Configurations



0401-08-000525



0401-08-000484



0401-08-000485



0401-08-000483



0401-08-000248



0401-08-000491



0401-08-000524



0401-08-000523



0401-08-000766



0401-08-000542



0401-08-001357

Modular Cartridge Retainer Configurations



0401-08-000489



0401-08-000486



0401-08-000487



0401-08-000490



0401-08-001408



0401-08-000488

Spare parts identifier guide located on pages 102 and 103.

4-Axis Universal Gantry & SCARA Holder Assemblies

Holder Assemblies for 4 Axis gantry and SCARA style robot platforms.

Allows for valves, syringes and cartridge retainers to be mounted directly to the bracket and fixed at an angle from 0° - 90°.

High quality assemblies for use with Fisnar's line of robots and dispense systems.

Kitted for easy out of the box plug and play assembly, designed to create a smoother and convenient installation, removal and setup experience.

Their unique design allows for valves to be quickly removed for maintenance requirements then re-installed without losing the original datum mounting position.

The Z-axis mounting position can also be adjusted to reduce working movement to the workplace in order to minimize robot cycle times.

Suitable for use with the following platforms:

- F8000 Series Gantry (4 Axis)
- F9000 Series Gantry (4 Axis)
- F2004N SCARA (4 Axis)



4-Axis Universal Syringe, Valve & Cartridge Retainer Holders



562195BU
Gantry Syringe Holder 4-Axis



562195VU
Gantry Valve Holder 4-Axis
For use with VP300, SV2000N, and
VD510 Series



562089U
Gantry Valve Holder 4-Axis
For use with SV1000SS



562220U
Gantry Valve Holder 4-Axis
For use with 790HP Series Valves



562158U
Gantry Valve Holder
For use with MV-0180 Valve



562055-TU
T-type Cartridge Retainer
Holder



562055-EU
E-type Cartridge Retainer
Holder



562050U
1/10th Gallon Cartridge
Retainer Holder

4-Axis Modular Syringe & Valve Configurations



0401-08-000485



0401-08-000483



0401-08-000246

Bushing included.



0401-08-000491



0401-08-000524



0401-08-000766



0401-08-001499



0401-08-000523



0401-08-000542

4-Axis Modular Cartridge Retainer Configurations



0401-08-000246

Bushing included.



0401-08-000489



0401-08-000488



0401-08-000487

Spare parts identifier guide located on pages 102 and 103.

Cartridge Retainer & Valve Backplate

Compatible with 3-axis robots and corresponding cartridge retainers. Ideal for feeding a valve from a prefilled cartridge system while optimizing fluid flow rate.

Suitable for use with the following platforms:

- F4000 Series Desktop (3-axis)
- F5000 Series Desktop (3-axis)



Example Configuration
CR300 with 790HP-LF valve.

Syringe, Valve & Cartridge Retainer Modular Configurations



0401-08-000489



0401-08-000490



0401-08-001408



0401-08-000487



0401-08-000488



0401-08-000249



0401-08-000250



0401-08-00483



0401-08-00484



0401-08-00525



0401-08-000766



0401-08-000542



0401-08-000491



0401-08-000524



0401-08-000523

Spare parts identifier guide located on pages 102 and 103.

Backplate Syringe & Valve Holder

Compatible with all 3-axis robots and corresponding cartridge retainers. Ideal for simultaneous dispensing from syringes, valves, and cartridges when increased productivity is required.

Suitable for use with the following platforms:

- F4000 Series Benchtop (3-axis)
- F5000 Series Benchtop (3-axis)



Example configuration dual syringe and light guide.



Example configuration 790HP valve and CR300 cartridge retainer.

Multi-Syringe, Valve, or Cartridge Retainer Modular Backplate Configurations

0401-08-00543



0401-08-000489



0401-08-000487



0401-08-000525



0401-08-000483



0401-08-000484



0401-08-000488



0401-08-000766



0401-08-000542



0401-08-000491



0401-08-000524



0401-08-000523



0401-08-000490



0401-08-000250



0401-08-001408



0401-08-001357



0401-08-000248



Spare parts identifier guide located on pages 102 and 103.

Spare Parts

	Item Number	Description
	0401-08-000483	Sliding Bracket Holder
	0401-08-000484	3-Axis Sliding Plate Holder
	0401-08-000525	3-Axis Sliding Square Plate Holder
	0401-08-000485	4-Axis Angled Sliding Plate Holder
	0401-08-000491	Universal Valve Holder - For use with VP300, VD510, and SV2000N Series Valves
	0401-08-000523	Universal Valve Holder For use with MV-0180LF Valve
	0401-08-001499	Syringe Holder Bottom Plate For use with 3, 5, 10, 30, and 55cc syringes
	0401-08-000524	Universal Valve Holder For use with 790HP-LF Valve
	0401-08-000766	Universal Valve Holder For use with SV1000SS Valve
	0401-08-000542	Universal Valve Holder For use with CV629 Valve
	0401-08-001357	Universal 710PT Valve Holder
	0401-08-000246	4-Axis Gantry and SCARA Mounting Bracket
	0401-08-000486	3-Axis Cartridge Retainer Holder
	0401-08-000489	Universal Cartridge Retainer Holder 2.5, 6, 8, and 12oz E-Type
	0401-08-000490	Universal Cartridge Retainer Holder 20oz T-Type
	0401-08-001408	Universal Cartridge Retainer Holder 20oz E-Type

Spare Parts

	Item Number	Description
	0401-08-000488	Universal Cartridge Retainer Holder 2.5, 6, 8, and 12oz T-Type
	0401-08-000487	Universal Cartridge Retainer Holder 300ml (1/10th Gallon)
	0401-08-000775	UV Light Guide Holder
	0401-08-000249	3-Axis Backplate Holder
	0401-08-000543	Multi-Syringe, Valve, and Cartridge Retainer Backplate
	0401-99-000777	Gantry Robot Holder Plate
	0401-99-000769	Benchtop Robot Spacer Bracket
	0401-08-000250	Adapter Nut Holder
	0401-99-000770-1	Sleeve Bushing for RobotKit-EADP400-85MLTPU
	0401-99-000770-2	Sleeve Bushing for RobotKit-EA200-400MLTPU and Robotkit-300PBMLTPU
	0401-99-000770-3	Sleeve Bushing for RobotKit-EADP200-70MLTPU
	0401-99-000281	Mixer Sleeve Bushing Holder without Screws
	0401-99-000282	Mixer Sleeve Bushing - 8mm
	0401-99-000283	Mixer Sleeve Bushing - 10mm
	0401-99-000284	Mixer Sleeve Bushing - Blank

Valve/Bracket/Holder & Stand Compatibility Chart

	Benchtop Robot		Gantry Robot		Rotary Table	Stands
Valves	3 & 5 Axis	4 Axis	3 Axis	4 Axis	F1300N	Workbench
790HP-LF	560927U	560927U	560927U	562220U	560927U	560671U
790HPSS-LF	560927U	560927U	560927U	562220U	560927U	560671U
VD510	562151U	562151U	562151U	562195VU	562151U	562143U
VD510-UV	562151U	562151U	562151U	562195VU	562151U	562143U
VD510-SS	562151U	562151U	562151U	562195VU	562151U	562143U
MV-0180LF	560928U	560928U	560928U	562158U	560928U	560536U
MV-0180SS	560928U	560928U	560928U	562158U	560928U	560536U
CV629	562064U	562064U	562064U	-	562064U	562166U
SV2000N	562151U	562151U	562151U	562195VU	562151U	562054U
SV1000SS	562088U	562088U	562088U	562089U	562088U	562054U
710PT-LF	561355U	561355U	561355U	-	561355U	562054U
PDV-1000	5601801U	5601801U	5601801U	-	5601801U	562235U
VMS400	5601801U	5601801U	5601801U	-	5601801U	562235U
VMP30H	5601801U	5601801U	5601801U	-	5601801U	562235U
VP300	562151U	562151U	562151U	562195VU	562151U	562143U
VDP150	5601801U	5601801U	5601801U	-	5601801U	562235U
Syringe/Retainer	3 & 5 Axis	4 Axis	3 Axis	4 Axis	F1300N	Workbench
Syringe Holder 3, 5, 10, 30/55cc	560920U	560920U	560920U	562195BU	560920U	560021U
Cartridge Holder 2.5, 6, 8, 12oz E-Type	560926-EU	560926-EU	560926-EU	562055-EU	560926-EU	-
Cartridge Holder 2.5, 6, 8, 12oz T-Type	560926-TU	560926-TU	560926-TU	562055-TU	560926-TU	560535U
Cartridge Holder 1/10th Gallon	561785U	561785U	561785U	562050U	561785U	560549U
Cartridge Holder 20oz E-Type	562297-EU	562297-EU	562297-EU	-	562297-EU	-
Cartridge Holder 20oz T-Type	562297-TU	562297-TU	562297-TU	-	562297-TU	560534U

Robot Kits

A range of pre-packaged robot kits specially designed to accommodate the most popular dispense applications. Each kit contains the dispense hardware that a user requires to connect to a Fisnar dispensing robot or dispense controller.



Robot Kit 6OZEU

Contains all required bracket components for mounting a 6oz EFD cartridge retainer to 3, 4, and 5-axis benchtop robots in order to directly dispense fluid material from the cartridge.

Includes:

- 6oz EFD Cartridge Retainer
- All additional required dispense accessories

Item Number

ROBOTKIT-6OZEU



Robot Kit 6OZTU

Contains all required bracket components for mounting a 6oz Techcon cartridge retainer to 3, 4, and 5-axis benchtop robots in order to directly dispense fluid material from the cartridge.

Includes:

- 6oz Techcon Cartridge
- All additional required dispense accessories

Item Number

ROBOTKIT-6OZTU



Robot Kit 300MLU

Contains all required bracket components for mounting a CR300 cartridge retainer to 3, 4, and 5-axis benchtop robots in order to directly dispense fluid material from 1/10th gallon (300ml) cartridges.

Includes:

- CR300 Cartridge Retainer
- All additional required dispense accessories

Item Number

ROBOTKIT-300MLU



Robot Kit CAU

Contains all required bracket components for mounting a VD510 diaphragm valve to 3, 4, and 5-axis benchtop robot for the dispensing of cyanoacrylate fluid materials. The system ensures cyanoacrylate fluid materials are pressurized and fed to the valve in a safe and controlled manner.

Includes:

- VD510
- IJ2601N-SS-SP
- All additional required dispense accessories



Item Number

ROBOTKIT-CAU

Robot Kit 300+790U

Contains all required bracket components for mounting both a CR300 cartridge retainer and a 790HP-LF high-pressure spool valve to 3-axis benchtop robot.

Reduces material flow path length from fluid material cartridge to dispense valve, resulting in optimized fluid flow rate.

Includes:

- CR300 Cartridge Retainer
- Pressure regulator assembly for controlling fluid pressure inside CR300 Cartridge Retainer
- 790HP-LF high pressure spool valve
- All additional required dispense accessories



Item Number

ROBOTKIT-300+790U

Twin-Pack Robot Kits

Fisnar's line of twin pack robot kits are specifically designed to accommodate 50ml, 200ml, and/or 400ml cartridges from a variety of manufacturers for use with Fisnar's line of 3-axis benchtop robots. Designed to hold and dispense cartridge systems. Setup can be used with or without a pinch tube valve for more precise material shut off for thinner materials.

Robot kits suit the following Fisnar robots:

- F4300N.1
- F4400N.1
- F4500N.1
- F9300N
- F9600N
- F9800N
- F8800N
- F8100N

Kits come complete with the following accessories to begin production testing:

- DCK800 Dispense Needle Selection Kit
- Luer Lock Adapters
- Sample Mix Nozzles for each size kit
- Pinch Tube Samples
- Air Input Line with 1/4" NPT Fitting
- P.E. Tubing 1/4" x 0.170" - Natural 40" long
- Air Line Block Assembly



Robot Kit 400ml

400ml (200ml/200ml) twin pack cartridge kit dispenser with 710PT valve for all 3-axis robots. Contains Sulzer pneumatic dispenser suitable for most low to medium viscosities. Compatible with most F-style and C-style Sulzer 400ml dual cartridges. Ready to use out of the box for 1:1 and 2:1 mix ratios, conversion kits included to adapt to 4:1 and 10:1.



Item Number

ROBOTKIT-EADP400-85MLTPU

Robot Kits - Other Available Models

Robot Kit 50ml

50ml (25ml/25ml) twin pack cartridge kit with 710PT valve for all 3-axis robots. Contains 50ml pneumatic dispenser suitable for most low to medium viscosities. Compatible with most A-style and B-style Sulzer dual cartridges. Ready to use out of the box for 1:1 and 2:1 mix ratios, pistons included to convert to 4:1 and 10:1.

Item Number

ROBOTKIT-50MLTPU

Robot Kit 200ml

200ml (100ml/100ml) twin pack cartridge kit with 710PT valve for all 3-axis robots. Contains Sulzer pneumatic dispenser suitable for most low to medium viscosities. Compatible with most F-style and C-style Sulzer 200ml dual cartridges. Ready to use out of the box for 1:1 and 2:1 mix ratios, conversion kits included to adapt to 4:1 and 10:1.

Item Number

ROBOTKIT-EADP200-70MLTPU

Robot Kit 600ml

600ml (300ml/300ml) twin pack cartridge kit with 710PT valve for all 3-axis robots. Contains Sulzer pneumatic dispenser suitable for low to high viscosities. Compatible with most PLAS-PAK style dual cartridges. 1:1 for 300ml x 300ml, 2:1 for 300ml x 150ml, and 4:1 for 300ml x 75ml.

Item Number

ROBOTKIT-300PBMLTPU

Robot Kit 200/400ml

200ml (100ml/100ml) and 400ml (200ml/200ml) twin pack cartridge kit with 710PT valve for all 3-axis robots for dispensing 200ml or 400ml dual cartridges. Compatible with most F-style and C-style Sulzer 200ml and 400ml dual cartridges. Ready to use out of the box for 1:1 and 2:1 mix ratios, pistons included to convert to 4:1 and 10:1.

Item Number

ROBOTKIT-200-400MLTPU

Robot Kit 400ml

400ml (200ml/200ml) twin pack cartridge kit with 710PT valve for all 3-axis robots. Contains Sulzer pneumatic dispenser with larger air cylinder for thicker, high viscosity materials requiring more thrust. Compatible with most F-style and C-style Sulzer 400ml dual cartridges. Ready to use out of the box for 1:1 and 2:1 mix ratios, conversion kits included to adapt to 4:1 and 10:1.

Item Number

ROBOTKIT-EADP400-100MLTPU

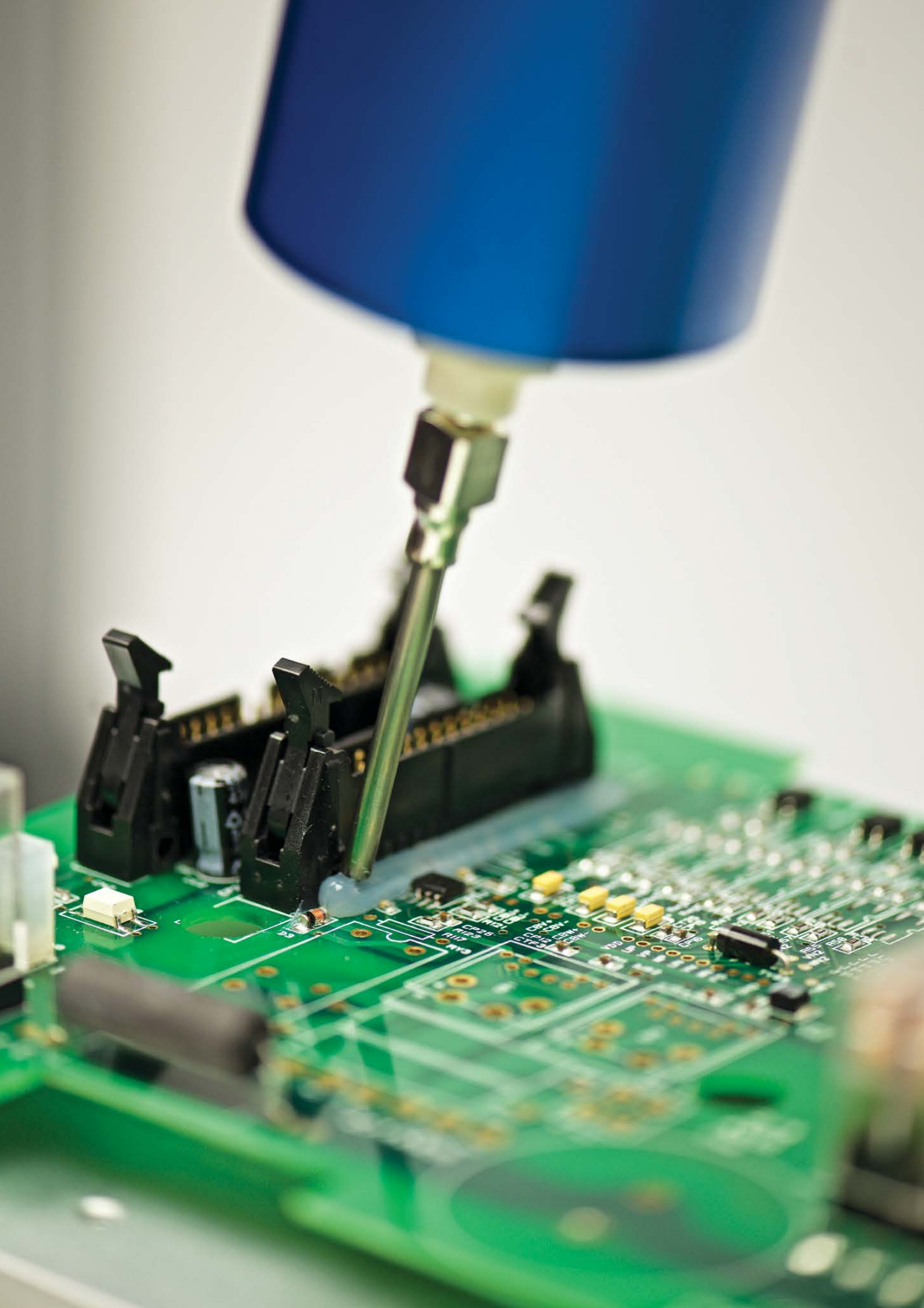



About Us

Fisnar is a leading manufacturer and supplier of precision fluid dispensing and fluid handling solutions.

With over 40 years' knowledge of the dispense industry and its global requirements, we have an accomplished range of dispensing products including dispensing robots, valves, dispensers, and a complete selection of consumables.

Armed with technical expertise and a diverse portfolio of dispensing products, Fisnar can supply a system to suit every budget, application, and industry.

Visit our website: www.fisnar.com

Contact Us

USA

info@fisnar.com
1 (262) 253-8600

Europe

infoeurope@fisnar.com
+44 (0) 1355 577222

Asia

info@fisnar.com.hk
+852 2389-2827

India

info@fisnar.in
+91-11-4556-6223-5



www.fisnar.com