

# GasMultiBloc® Combined regulator and safety shut-off valves Single-stage function

**DUNGS®**  
Combustion Controls

**MB-D(LE) 415 - 420 B01**

7.23

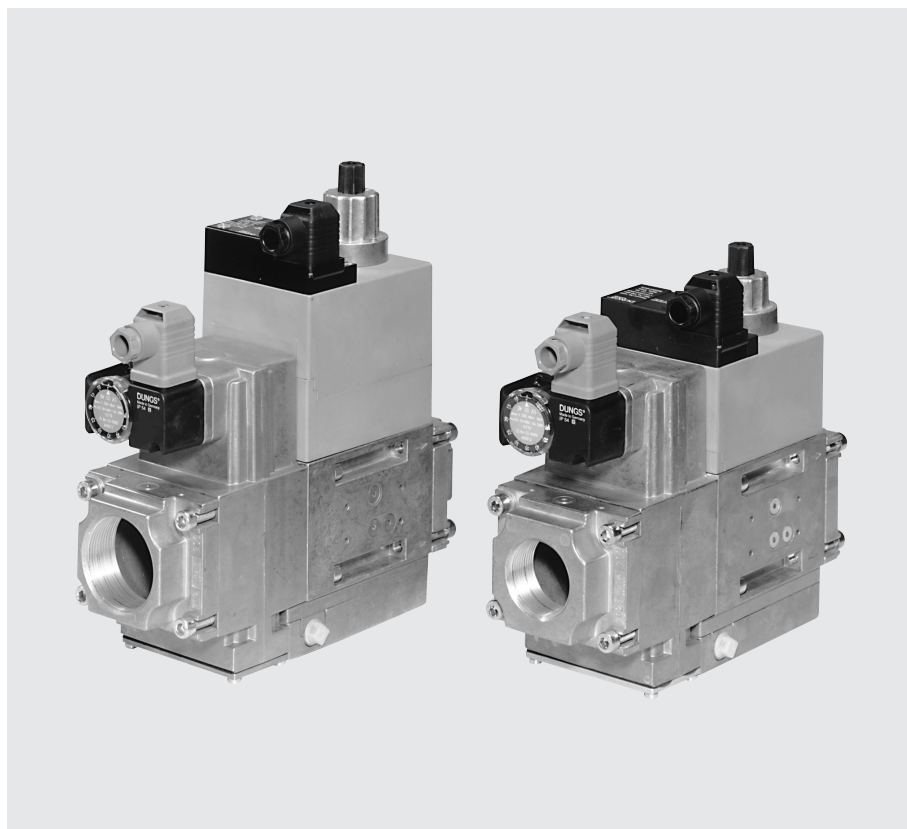

## Technical description

The DUNGS GasMultiBloc® integrates filter, regulator, valves and pressure switches in one compact fitting.

- Dirt trap: microfilter
- One regulator and two valves: B01
- Two valves are fast opening
- One valve is fast opening and one valve is slow opening
- Solenoid valves up to 360 mbar (36 kPa) as per DIN EN 161 Class A Group 2
- Sensitive setting of output pressure by proportional regulator as per DIN EN 88 Class A Group 2
- High flow rates with low pressure drop
- DC solenoid drive interference degree N
- Main volume restrictor at valve V2
- Hydraulic opening delay
- Flange connections with pipe threads as per ISO 7/1
- Simple mounting, compact, light-weight

The modular system permits individual solutions by using external ignition gas tap in connection with separately controlled valves, by adding a valve proving system, mini/maxi pressure switches, pressure limiters, limit switch at valve V2.

## Application

The modular system permits individual solutions in gas safety and regulator engineering. Suitable for gases of families 1, 2, 3 and other neutral gaseous media.

## Approvals

EU type test approval as per EU Gas Appliance Directive.

MB-...415-420 B01 CE-0085 AP 3156

EC type test approval as per EC Pressure Equipment Directive:

MB-...415-420 B01 CE0036

Approvals in other important gas consuming countries.

## Functional description of gas flow

1. When the valves V1 and V2 are closed, chamber A is under inlet pressure.
2. A hole D in the filter housing connects min. pressure switch with chamber A. If the inlet pressure applied to the pressure switch exceeds the incoming reference value, it switches through to the automatic burner control.
3. After release by the automatic burner control, valves V1 and V2 open. The gas flows through chambers A, B and C of the GasMultiBloc.

## Operating method of valve-regulator combination on valve V1

A regulator, compensating for residual pressure is integrated in valve V1 (pressure regulating part). Armature 7 is not connected with valve plate unit 3. When it opens, armature 8 pretensions compression spring (V1) 5 and releases the valve plate unit.

When the valve closes, the armature acts directly on the valve plate unit.

The output pressure upstream of valve V2 is defined by pretensioning regulating spring 8 (tension spring) via setting screw 17.

The output pressure acts via opening E on the working diaphragm 21 of the regulator part. In regulated state, setting spring inlet pressure and pressure of working diaphragm are in force equilibrium.

The compensating diaphragm 22 ensures the fast closing function of valve V1 and a high regulating quality.

## Operating method of valve V2

The armature 14 of valve V2 is connected to valve plate unit 12. When it opens, armature 14 pretensions the closing spring 13. The max. valve opening can be set by limiting the armature stroke by means of the main volume restrictor 18.

## Min. opening (residual stroke) of valve (0.5 to 1.0 mm)

The main volume restrictor 18 is set by rotating the adjusting plate or the hydraulic brake 20. The fast and/or slow opening characteristic is influenced by setting fast stroke 19 at the hydraulic brake under the cover.

## Closing function

When the supply voltage to the solenoid coils of valves V1 and V2 is interrupted, they are closed within < 1 s by the compression springs.

## Sectional drawing of MB-DLE...

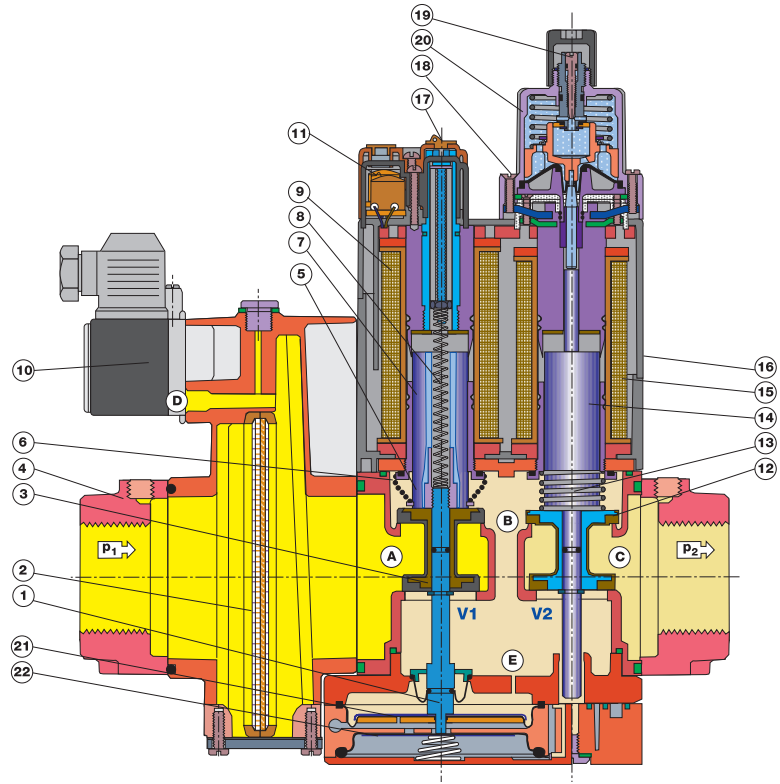

1	Pressure regulator	9	Solenoid V1	Setting:
2	Microfilter	10	Gas pressure switch	17 - Gas pressure $p_a$
3	Valve V1	11	Electrical connection	18 - Main volume
4	Connection flange	12	Valve V2	19 - Fast stroke
5	Closing spring V1	13	Closing spring V2	20 Hydraulic brake
6	Housing	14	Armature V2	21 Working diaphragm
7	Armature V1	15	Solenoid V2	22 Compensation diaphragm
8	Regulating spring	16	Solenoid housing	

## Pressure taps

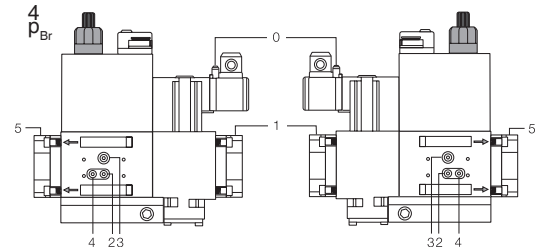
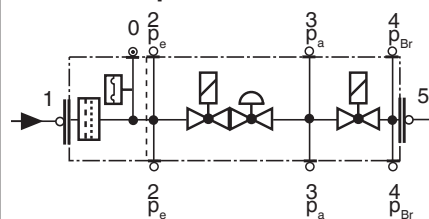

0, 1, 2, 3, 4, 5  
screw plug G 1/8

## Electrical connection

S 20/S 50

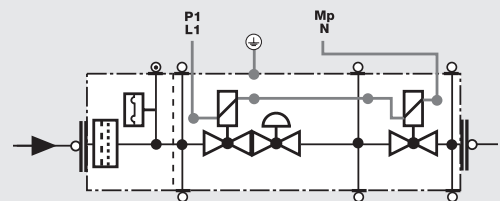
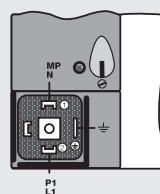

S 22/S 52

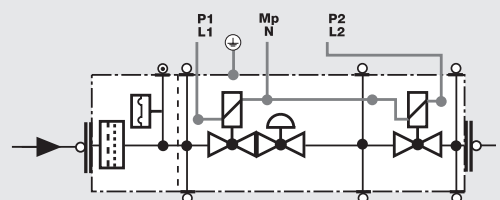
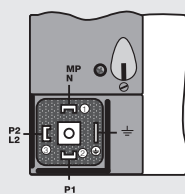

## Specifications

Nominal diameters Flange with pipe threads as per ISO 7/1 (DIN 2999)	MB-D... 415 B01 Rp 1, 1 1/4, 1 1/2, 2 and their combinations	MB-D... 420 B01 Rp 1, 1 1/4, 1 1/2, 2 and their combinations																					
<b>Max. operating pressure</b>	<b>360 mbar (36 kPa)</b>																						
<b>Output pressure ranges</b>	<b>MB-... S20/S22 p<sub>a</sub>: 4 mbar (0.4 kPa) to 20 mbar (2 kPa)</b> <b>MB-... S50/S52 p<sub>a</sub>: 20 mbar (2 kPa) to 50 mbar (5 kPa)</b>																						
Media	Gases of families 1, 2, 3 and other neutral gaseous media																						
Ambient temperature	-15 °C to +70 °C (Do not operate MB-D below 0 °C in liquid gas systems. Only suitable for gaseous liquid gas, liquid hydrocarbons destroy sealing materials.)																						
Dirt trap	Sieve, microfilter, changing the filter is possible without removing the valve.																						
Pressure switches	Types GW...A5, ÜB...A2 / NB...A2 to DIN EN 1854 may be attached. For further information, refer to Datasheets 5.02 and 5.07 "Pressure Switches for DUNGS Multiple Actuators"																						
Pressure regulator	Pressure regulator compensated for residual pressure, leakproof seal when switched off by means of valve V1 as per DIN EN 88 Class A. Setpoint spring permanently installed (no spring exchange possible). A vent line above roof is not required. Internal pulse tap provided.																						
Solenoid valve V1	Valve as per DIN EN 161 Class A Group 2, fast closing, fast opening																						
Solenoid valve V2	Valve as per DIN EN 161 Class A Group 2																						
	<table border="1"> <thead> <tr> <th></th> <th colspan="2">Valve V2 design</th> <th>Main volume restrictor</th> </tr> </thead> <tbody> <tr> <td>MB</td> <td>fast closing</td> <td>fast opening</td> <td>without</td> </tr> <tr> <td>MB-D</td> <td>fast closing</td> <td>fast opening</td> <td>with</td> </tr> <tr> <td>MB-DLE</td> <td>fast closing</td> <td>slowly opening</td> <td>with</td> </tr> <tr> <td>MB-LE</td> <td>fast closing</td> <td>slowly opening</td> <td>without</td> </tr> </tbody> </table>				Valve V2 design		Main volume restrictor	MB	fast closing	fast opening	without	MB-D	fast closing	fast opening	with	MB-DLE	fast closing	slowly opening	with	MB-LE	fast closing	slowly opening	without
	Valve V2 design		Main volume restrictor																				
MB	fast closing	fast opening	without																				
MB-D	fast closing	fast opening	with																				
MB-DLE	fast closing	slowly opening	with																				
MB-LE	fast closing	slowly opening	without																				
Measuring / Ignition gas connection	For G 1/8 as per DIN ISO 228, refer to Pressure taps on page 2																						
Burner pressure monitor p <sub>Br</sub>	Connection downstream of valve V2, pressure switch mountable on adapter laterally																						
Voltage / Frequency	50 - 60 Hz 220 - 230 V AC -15 % +10 % Other preferred voltages: 240 VAC, 110 - 120 VAC, 48 VDC, 24 - 28 VDC																						
Electrical connection	Plug connection as per DIN EN 175301-803 for valves and pressure switches																						
Rating / Power consumption Switch-on duration Degree of protection Radio interference	at 230 V AC; +20 °C: refer to Dimensions on page 5 100% IP 54 as per IEC 529 (EN 60529) Interference degree N																						
Materials of gas conveying parts	Housing Diaphragms, seals Solenoid drive	aluminium die casting NBR basis, Silopren (silicone rubber) steel, brass, aluminium																					
Installation position	Solenoid vertically upright or lying horizontally as well as its intermediate positions.																						
Closed position signal contact	Closed position signal contact, type K01/1 (DIN-tested), mountable on V2																						

Equipment variants GasMultiBloc®...B01 Single-stage function	415 B01	420 B01	
MB	•	•	Filter element can be removed. A suitable GF.../1 gas filter must then be fitted upstream.
MB-D	•	•	
MB-DLE	•	•	
MB-LE	•	•	
Microfilter	•	•	
Gas pressure switch downstream of filter	•	•	
downstream of valve V2 on adapter	•	•	
Pressure regulator	•	•	
Valve V1, double seat	•	•	
Valve V2, double seat	•	•	
Valves opening together	•	•	• = possible (•) = on request - = not possible
Valves opening separately	•	•	
Flange Rp 1	•	•	
Rp 1 1/4	•	•	
Rp 1 1/2	•	•	
Rp 2	•	•	

### MB-...B01 version

- V1 = Valve 1
- V2 = Valve 2
- 3 = Filter
- 4 = Pressure switch, optional
- 5 = Regulator

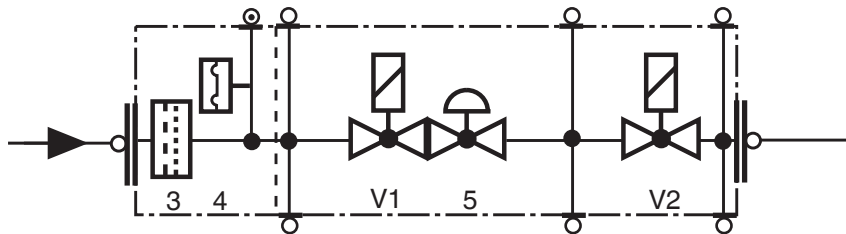

Mounting of VPS 504 valve proving system possible  
Mounting of K01/1 closed position signal contact possible

For further information, refer to Datasheet 7.04: GasMultiBloc Modular System, Accessories, Additional equipment

### Type key of MultiBloc®

MB- XX XXX XX BOX SXX

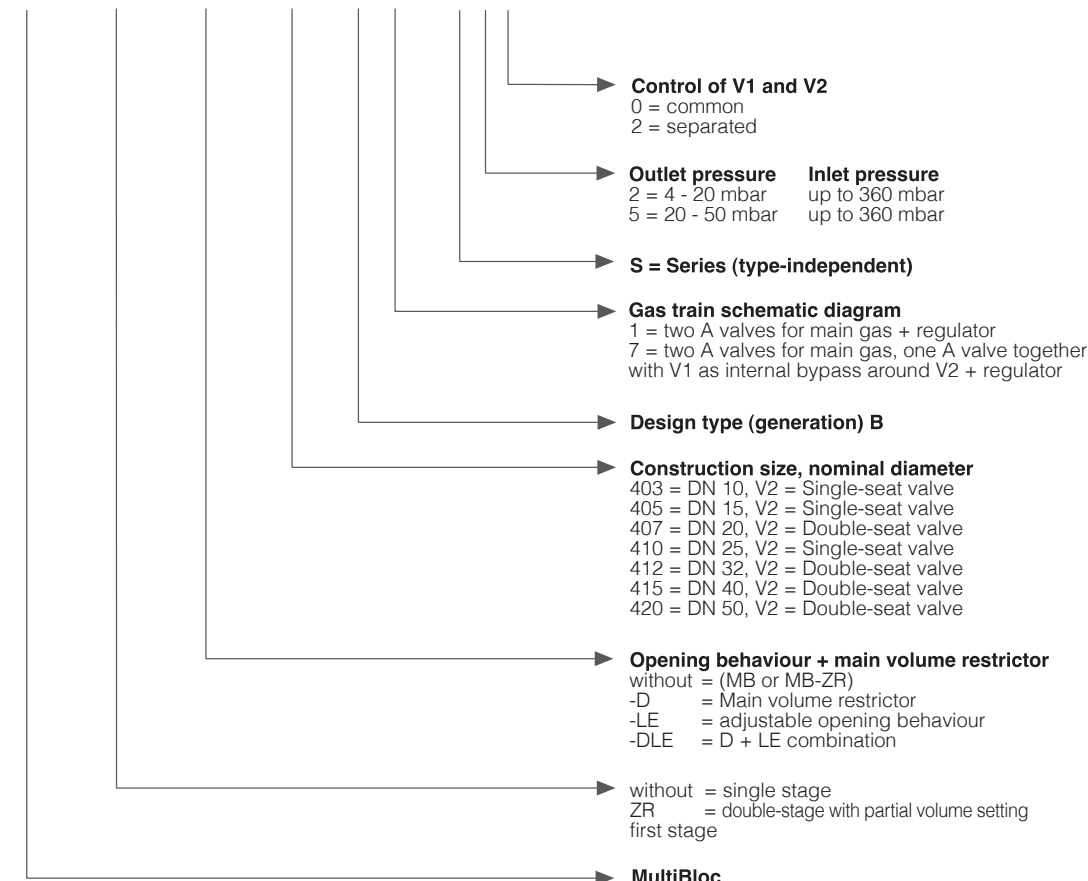

## Dimensions [mm]

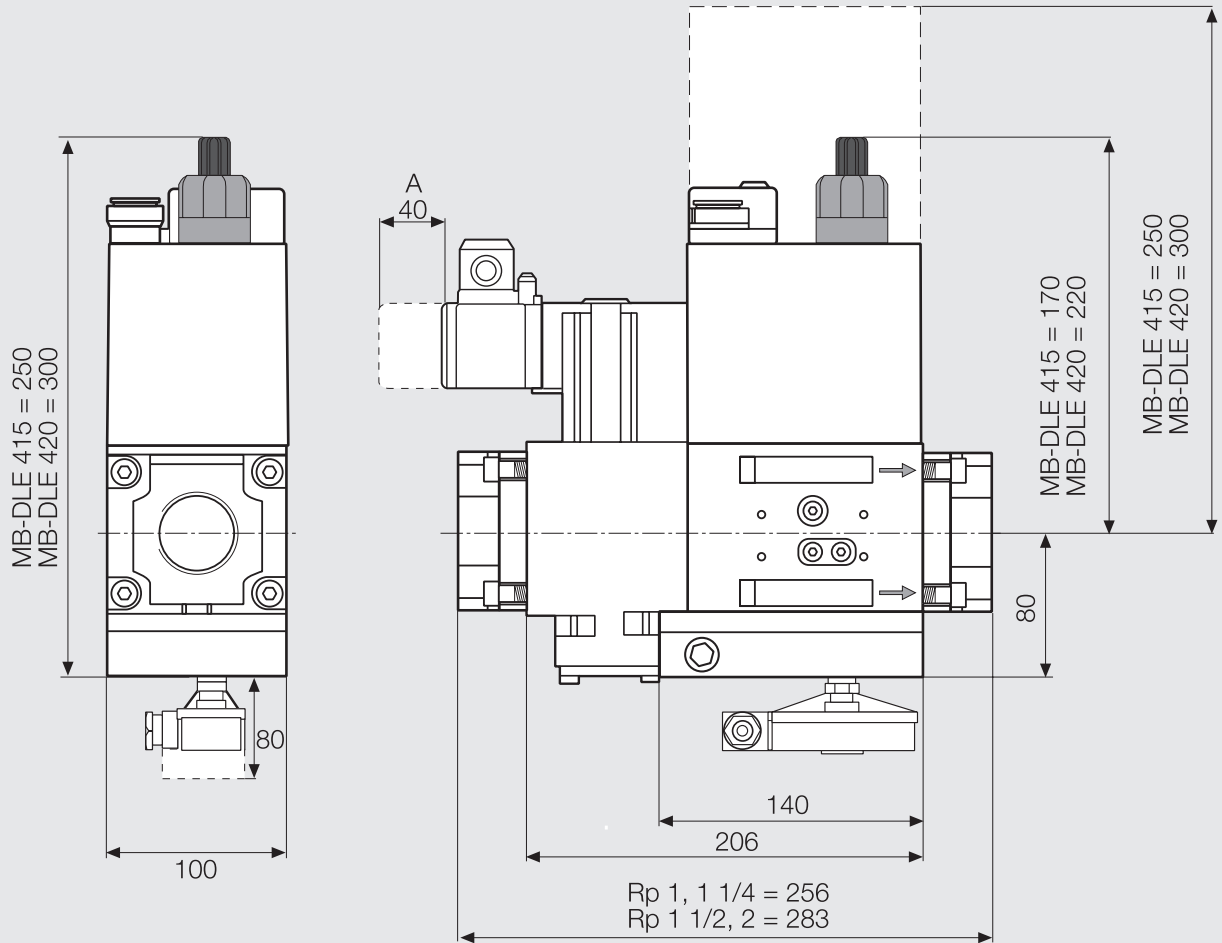

Type	Rp	Opening time	Nominal rating[VA]				Weight [kg]
			~(AC) 230 V AC; +20°C				
			S20	S22	S50	S52	
MB-D 415 B01	Rp 1 - 2	< 1 s	55	96	55	96	6.5
MB-DLE 415 B01	Rp 1 - 2	< 20 s	55	96	55	96	6.6
MB-D 420 B01	Rp 1 - 2	< 1 s	80	100	80	100	7.7
MB-DLE 420 B01	Rp 1 - 2	< 20 s	80	100	80	100	7.8

**GasMultiBloc®**  
**Combined regulator and safety**  
**shut-off valves**  
**Single-stage function**

**MB-D(LE) 415 - 420 B01**



**Volumetric flow pressure loss characteristics in regulated state with microfilter**

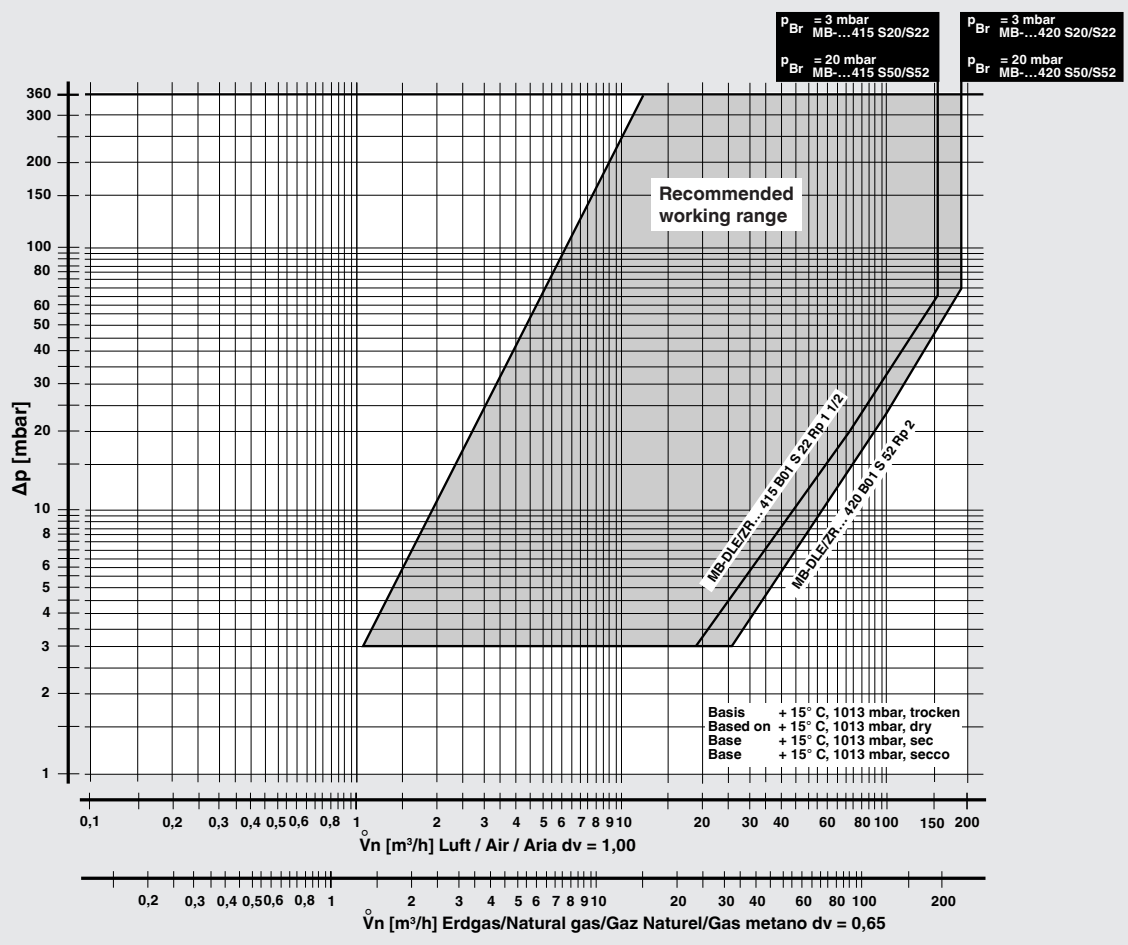

Basis + 15° C, 1013 mbar, trocken  
 Based on + 15° C, 1013 mbar, dry  
 Base + 15° C, 1013 mbar, sec  
 Base + 15° C, 1013 mbar, secco

$$f = \frac{\text{Dichte Luft} / \text{Spec. weight air} / \text{poids spécifique de l'air} / \text{peso específico aria}}{\text{Dichte des verwendeten Gases} / \text{Spec. weight of gas used} / \text{poids spécifique du gaz utilisé} / \text{peso específico del gas utilizzato}}$$

Gas type	Density [kg/m³]	dv	f
Nat. gas	0.81	0.65	1.24
City gas	0.58	0.47	1.46
LPG	2.08	1.67	0.77
Air	1.24	1.00	1.00

$$\dot{V}_{\text{verwendetes Gas/gas used/ gaz utilisé/gas utilizzato}} = \dot{V}_{\text{Luft/air/air/aria}} \times f$$

We reserve the right to make any changes in the interest of technical progress.

**Head Offices and Factory**  
**Karl Dungs GmbH & Co. KG**  
**Siemensstraße 6-10**  
**D-73660 Urbach, Germany**  
**Telephone +49 (0)7181-804-0**  
**Fax +49 (0)7181-804-166**

**Postal address**  
**Karl Dungs GmbH & Co. KG**  
**Postfach 12 29**  
**D-73602 Schorndorf, Germany**  
**e-mail info@dungs.com**  
**Internet www.dungs.com**