

Standard, Industrial and Multifunction radio remote controls

Orion Series

Typical applications:

◆ Industrial equipment

- Cardboard box folding and gluing machines
- Packaging machines
- Wrapping machines
- Dynamic storage
- Conveyors
- Ovens
- Book stitching machines
- Machine control in stepped mode
- Small lifting equipment
- Lift tables

◆ Industrial vehicles

- Milk transport
- Recovery vehicles
- Impoundment vehicles
- Clean-up vehicles
- Vehicle carriers
- Tailgates
- Skips
- Winches

◆ Farm equipment

- Wine making pumps
- Liquid manure tanks
- Fruit grading machines
- Sprinkling systems
- Debarking machines
- Logging equipment
- Mangers and livestock feeding equipment



◆ Building industry equipment

- Freight elevators
- Concrete mats
- Concrete plants
- Hoppers
- Quarry conveyors
- Asphalt spreader

◆ Infrastructure equipment

- Automatic industrial doors
- Industrial gates
- Industrial drop gates
- Staging equipment
- Signalling
- Industrial lighting
- Industrial production operator calls
- Traffic lights on industrial site
- Sluice gates
- Industrial pressure cleaners



1- Description

▶▶▶ A radio remote control provides significant advantages:

- Large freedom of movement
- Easy to use
- Precise, quality manoeuvres
- Visibility
- Productivity

▶▶▶ Jay Electronique's new **Orion** radio remote control line is designed to satisfy the needs of a wide range of standard and industrial applications, including simple and multifunction applications.

▶▶▶ The **Orion** line comprises a broad range of transmitters and receivers, providing different types and numbers of functions, satisfying a variety of requirements.

▶▶▶ This product line also incorporates numerous features and significant technological breakthroughs:

- European frequency band of 433-434 MHz with 18 possible frequencies
- FM radio link
- Simultaneous commands
- Programming of different functions by jumpers in receiver, or using buttons on transmitter, thus enabling numerous possibilities:
 - programming of identity code,
 - association of transmitter(s) / receiver(s),
 - association of transmitter button(s) / receiver(s) relays,
 - programming of operating mode,
 - programming of command interlocking functions,
 - programming of radiofrequency channel (on certain models),
 - programming of "standby function" time (on certain models),
 - programming of "radio power" (on certain models),
- compact, light-weight, watertight and sturdy transmitters and receivers.
- mechanical protection for buttons
- "on/off" button (on some models)

CONTENTS

Para.	Page
1	Description 1 & 2
2	Transmitter and receiver associations 3
3	Transmitter technical characteristics 4 & 5
4	Receiver technical characteristics 6 & 7
5	Accessories 8
6	Connection diagrams 9
7	Product dimensions 10
8	Selection guides 11 & 12

- **Compliance with European directives:**
 - Machinery
 - Hertzian equipment and telecommunication terminals (low voltage, EM compatibility, radiofrequency spectrum)
- ART conformity certificate



1- Description (cont.)

Operating reliability

Orion Series features designed to ensure operating reliability :

- ◆ A radio link that is non directional and insensitive to obstacles, thus enhancing the availability of the system.
- ◆ A momentary radio link to reduce the risks of interferences by other systems operating on the same band of frequencies.
- ◆ Individually coded transmitter+receiver sets (user programmable).
- ◆ A response time compatible with most of the equipment controlled.
- ◆ Possibility for electrical interlocking of conflicting commands (for example: up/down) by setting receiver outputs to "break" state (programmable by user).
- ◆ Hamming distance (minimum number of bits that differ between 2 messages that are different) of 4.
- ◆ An «On/Off» function (category B stop per EN954-1) available with transmitters equipped with «On/Off» button and receivers equipped with «On» relay. **it is necessary to ensure that the safety level of this product is acceptable for the risk level of the controlled equipment in the application, and if necessary, verify the presence of a wired emergency stop button on the equipment.**
- ◆ A receiver passive stop function in the event of radio jamming (for a duration of around 1 second) when a button on the transmitter is pressed and held.

Button/relay operating modes

There are three operating modes (programmable by user):

- ◆ **«Continuous make contact» mode:**
The receiver relay remains closed so long as the corresponding control button on the transmitter remains pressed.
- ◆ **«Continuous break contact» mode:**
The receiver relay remains open so long as the corresponding control button on the transmitter remains pressed.
- ◆ **«Bistable» mode:**
The receiver relay is closed the first time the corresponding control button on the transmitter is pressed, and opens on the second time the control button is pressed.

If a system is used in continuous mode with the control buttons maintained pressed and the operator moving about, transmission interruptions can occur due to the dispersion and propagation of radiowaves which must be taken into account in accordance with the application.

List of available radio channels :

"ORION Series" Channel number	Frequency MHz
01	433.100
02	433.200
03	433.300
04	433.400
05	433.500
06	433.600

"ORION Series" Channel number	Frequency MHz
07	433.700
08	433.800
09	433.900
10	434.000
11	434.100
12	434.200

"ORION Series" Channel number	Frequency MHz
13	434.300
14	434.400
15	434.500
16	434.600
17	434.700
18	434.740

The transmitters and receivers are supplied programmed in their standard configuration on channel No. 17 (434.700 MHz).

The radio channel can only be modified with transmitters equipped with an «On/Off» button.

Installation of other radio systems

To avoid any risk of extended radio jamming, be sure not to install or use, in the vicinity and at the same time, any other radio system with continuous transmissions in a frequency range representing +/- 100 kHz with respect to the product's operating frequency.

The distance between the interfering transmitter and the product will also impact the possibility of interference occurring. Be sure to keep the interfering transmitter as far away as possible from the product.

Operating with multi-receiver selection

It is possible to select the receiver you want to control with transmitter equipped with "Start / Stop" button + 4 function buttons minimum .







Special features of transmitters equipped with «On/Off» button

- The «On/Off button» is used to switch on and off the transmitter, thus avoiding any unintentional actions on the function buttons.
- This button also controls the receiver «on» relay (depending on model), thus doubling the command interruption feature.
- Transmitters equipped with this button have two functions which can be configured by the user:
 - **«Standby» time delay function** : time programmable for 4mn, 15mn, 60mn, 30s (only with OREV and OREL with «On/Off» button) or deactivation of function. If none of the buttons are pressed while the transmitter is on, it automatically shuts down at the end of the programmed time delay period. This causes the receiver relay to go to the «relaxed» state.
 - **Modification of radio working frequency:** The user can choose and program a frequency among 18 radio channels. Once the frequency has been selected, the transmitter automatically sends a frequency change command to the receiver.
 - **Changing the radio power (only with transmitter OREV):** The user can choose between 5 levels of transmitter radio power to adjust the radio power to limit or adapt the range in accordance with the application and the desired endurance.

2- Transmitter(s) and receiver(s) associations

All transmitter(s)/receiver(s) associations are possible by the user.





2.1- Association of 1 transmitter to 1 receiver, without «on/off» function: $\boxed{T} \rightsquigarrow \boxed{R}$

Number of functions required	Transmitter			Receiver		
	 Standard	 Industrial	 Multifunction	 DIN Rail	 Industrial small model	 Industrial large model
1	<input type="checkbox"/>	<input type="checkbox"/>	<input type="checkbox"/>	<input type="checkbox"/>	<input type="checkbox"/>	<input type="checkbox"/>
2	<input checked="" type="checkbox"/>	<input checked="" type="checkbox"/>	<input type="checkbox"/>	<input checked="" type="checkbox"/>	<input checked="" type="checkbox"/>	<input type="checkbox"/>
3	<input type="checkbox"/>	<input type="checkbox"/>	<input type="checkbox"/>	<input type="checkbox"/>	<input type="checkbox"/>	<input type="checkbox"/>
4	<input checked="" type="checkbox"/>	<input checked="" type="checkbox"/>	<input type="checkbox"/>		<input checked="" type="checkbox"/>	<input type="checkbox"/>
5			<input type="checkbox"/>			<input type="checkbox"/>
6			<input type="checkbox"/>			<input type="checkbox"/>
7			<input type="checkbox"/>			<input type="checkbox"/>
8			<input checked="" type="checkbox"/>			<input checked="" type="checkbox"/>
9			<input type="checkbox"/>			<input type="checkbox"/>
10			<input type="checkbox"/>			<input type="checkbox"/>
11			<input type="checkbox"/>			<input type="checkbox"/>
12			<input type="checkbox"/>			<input type="checkbox"/>
13			<input type="checkbox"/>			<input type="checkbox"/>
14			<input type="checkbox"/>			<input type="checkbox"/>
15			<input type="checkbox"/>			<input type="checkbox"/>
16			<input checked="" type="checkbox"/>			<input checked="" type="checkbox"/>

= Possible association

= Optimum association of number of buttons on transmitter and number of relays available in receiver.

2.2- Association of 1 transmitter to 1 receiver, with «on/off» function: $\boxed{T_0} \rightsquigarrow \boxed{R_0}$

Number of functions required	Transmitter		Receiver		
	 Industrial	 Multifunction	 DIN Rail	 Industrial small model	 Industrial large model
1 + "on/off"	<input type="checkbox"/>	<input type="checkbox"/>	<input type="checkbox"/>	<input type="checkbox"/>	<input type="checkbox"/>
2 + "on/off"	<input checked="" type="checkbox"/>	<input type="checkbox"/>	<input checked="" type="checkbox"/>	<input type="checkbox"/>	<input type="checkbox"/>
3 + "on/off"	<input type="checkbox"/>	<input type="checkbox"/>		<input type="checkbox"/>	<input type="checkbox"/>
4 + "on/off"	<input checked="" type="checkbox"/>	<input checked="" type="checkbox"/>		<input checked="" type="checkbox"/>	<input type="checkbox"/>
5 + "on/off"		<input type="checkbox"/>			<input type="checkbox"/>
6 + "on/off"		<input type="checkbox"/>			<input type="checkbox"/>
7 + "on/off"		<input type="checkbox"/>			<input type="checkbox"/>
8 + "on/off"		<input checked="" type="checkbox"/>			<input checked="" type="checkbox"/>
9 + "on/off"		<input type="checkbox"/>			<input type="checkbox"/>
10 + "on/off"		<input type="checkbox"/>			<input type="checkbox"/>
11 + "on/off"		<input type="checkbox"/>			<input type="checkbox"/>
12 + "on/off"		<input type="checkbox"/>			<input type="checkbox"/>
13 + "on/off"		<input type="checkbox"/>			<input type="checkbox"/>
14 + "on/off"		<input type="checkbox"/>			<input type="checkbox"/>
15 + "on/off"		<input type="checkbox"/>			<input type="checkbox"/>
16 + "on/off"		<input checked="" type="checkbox"/>			<input checked="" type="checkbox"/>

= Possible association

= Optimum association of number of buttons on transmitter and number of relays available in receiver.

2.3- Association of N transmitter(s) to M receivers: $\begin{matrix} \boxed{T} \\ \dots \\ \boxed{T} \end{matrix} \rightsquigarrow \begin{matrix} \boxed{R} \\ \dots \\ \boxed{R} \end{matrix}$

Any number of transmitters ORE can be associated to any number of receivers ORR depending on the needs of the application.

Each relay in the ORR receivers can be associated independently to any button of a transmitter by a simple «learning» procedure.

3- Transmitter technical characteristics

3.1 Characteristics common to 3 transmitter versions (standard, industrial et multifunction)



Operating mode	Simultaneous commands
Transmission module⁽¹⁾	18 frequencies per device
Transmission frequency⁽¹⁾	UHF 433,100 MHz to 434,740 MHz
Transmission power⁽¹⁾	< 1 mW (license not required) built-in antenna 5 adjustable power levels are available on transmitter OREV
Average range⁽²⁾	150 m in unobstructed area 50 m in typical industrial environment (possibility of limiting the radio range on transmitter OREV)
Modulation	FM
Radio link	Momentary (when command button pressed)
Identity code	256 codes programmable by microswitches on transmitter ORET, and OREL 4096 codes programmable by microswitches + internal button on transmitter OREV
Operating temperature range	-20° C to + 50° C
Storage temperature range	-30° C to + 70° C
Battery or accumulator charge level indication	2 indication levels by a red indicator light: Red ind. light off = batteries or accumulators charge is > 10% Red ind. light flashes fast = batteries must be replaced or accumulators must be recharged.
Other indication	Model without "on/off" button: a green indicator light comes on and flashes while the function button is pressed. Model with "on/off" button: A green indicator light comes on and flashes when the transmitter keypad is active.
Fastening	<ul style="list-style-type: none"> • Carrying clip (optional accessory, see chapter 8) • Fixation support (optional accessory, see chapter 8)

(1) = Supplied programmed on channel No. 17 in standard configuration.

REMINDER: The transmitters radio channel can only be changed on the ORE transmitters equipped with an «on/off» button.

(2) = The range varies according to environment conditions, the position of reception antenna and transmitter orientation (the range is decreased in case of metal obstacles such as: metal frameworks, walls etc.)

3.2 Characteristics specific to each version

	 standard (ORET)	 industrial (OREV)	 multifunction (OREL)
Housing	ABS	ABS	ABS
Housing color	black	yellow	yellow
Degree of protection	IP40	IP65	IP65
Weight (with batteries or accumulators)	65 g	105 g	160 g
Number of command buttons	1, 2 or 4	2 or 4	4, 6, 8, 12 or 16
Power supply	2 x 1,5V batteries type AAA ⁽³⁾	2 x 1,5V batteries type AAA ⁽³⁾	3 x 1,5V batteries (type AAA) or 3 x accumulators (type AAA) ⁽⁴⁾
Autonomy	1 year (for a typical use of 50 times per day with impulses of 5 seconds)		Supplied with batteries: same time standards or industrial transmitters Supplied with accumulators: 42h for 50 % use time
Charging time (supplied with accumulators)			< 3 h
Charging temperature range (supplied with accumulators)			0°C to +40°C
Safety			1 "on/off" button (depending on model)
Mechanical protection			Protective foam, reference : OWE30 (optional accessory)
Storage	Case, reference : OWE13 (optional accessory)	Case, reference : OWE14 (optional accessory)	Case, reference : UBWE34 (optional accessory)

(3) = Supplied with 2 AAA batteries.

(4) = Supplied with 3 AAA batteries; can be used with 3 AAA accumulators.

These transmitters, when equipped with AAA accumulators, can be recharged directly on an **ORCL**• charger support. The charger support must be ordered separately.

3.3 Product ranges

«Standard» models (ORET):

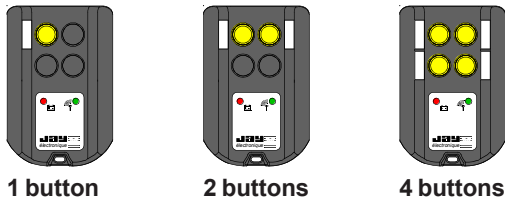

«Industrial» models (OREV):

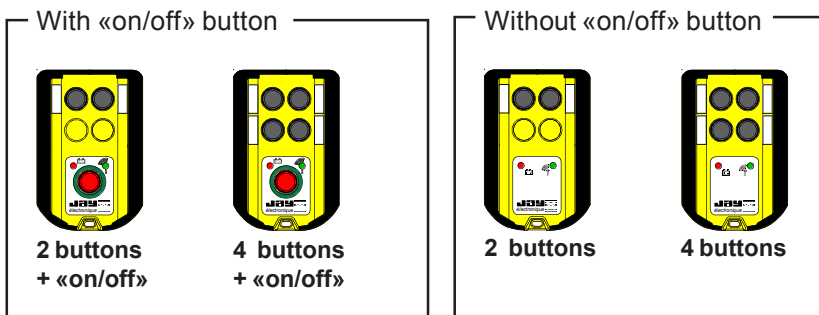

«Multifonction» models (OREL):

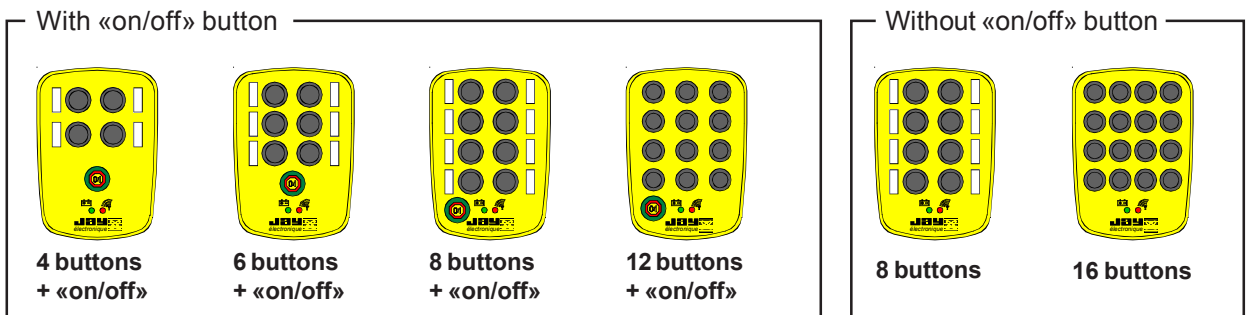

3.4 Indicator light functions

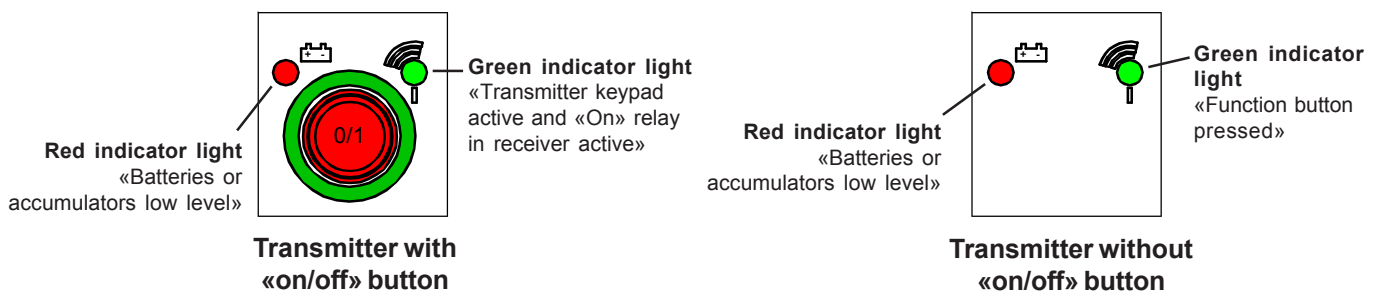



4- Receiver technical characteristics

4.1 Characteristics common to 3 receiver versions (DIN rail, small and large industrial model)

Operating temperature range	-20°C to +50°C
Storage temperature range	-30°C to +70°C
Tuner ⁽¹⁾	UHF 433,100 MHz to 434,740 MHz
Sensitivity	< 2µV
Identity code	By a "learning" procedure, the receiver relays can memorize the identity codes of the associated transmitters
Protection of power supply	<ul style="list-style-type: none"> Against overcurrents : 1 fuse on phase (ORRS and ORRA). Against polarity inversions in the case of 12VDC power supply.
Outputs	<p>Type of command by relay with 1 NO contact (1 NC or bistable contact possible by programming)</p> <p>min. / max. current 10 mA / 8A (50mA recommended)</p> <p>max. voltage 250 VAC</p> <p>response time 50 ms</p> <p>Switching category DC13 at 0,5 A / 24 VDC - AC15 at 3 A / 250VAC</p>
Operating mode	Continuous or bistable (by programming jumper or microswitch)
Interlocking	Programmable by jumper or microswitch
Additional function	1 "on" relay (controlled by transmitter "on/off" button - depending on transmitter model), B category according to EN 954-1.

4.2 Characteristics specific to each version

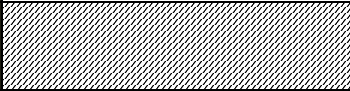
	 DIN rail (ORRD)	 Industrial "small model" (ORRS)	 Industrial "large model" (ORRA)
Housing material	PC-GF	ABS	
Housing color	Grey	Yellow	Grey
Degree of protection	IP 20	IP 65	
Number of command outputs	3 or 2+1 ⁽²⁾	2 or 4+1 ⁽²⁾	8+1 ⁽²⁾ or 16+1 ⁽²⁾
Maximum weight	220 g	350 g	1200 g
Maximum number of transmitter function buttons ⁽³⁾ being able to be learned by a function relay	10		4
Number of relay outputs simultaneously controllable	3 function relays or 2 function relays + 1 "On" relay	ORRS21**** model 2 function relays ORRS42**** model 4 function relays or 3 function relays + 1 "On" relay	All models 9 function relays or 8 function relays + 1 "On" relay
Power supply		ORRS****F model 12 VDC (9 to 20VDC) 24 VDC (20 to 75VDC) 24 VAC (+10%/-5%) 48 VAC (+10%/-15%) ORRS****T model 115 VAC (+10%/-15%) ORRS****U model 230 VAC (+10%/-15%)	ORRA****4 model 12 VDC (9 to 20VDC) 24 VDC (20 to 28VDC) ORRA****A model 24 VAC (+10%/-15%) 48 VAC (+10%/-15%) ORRA****B model 115 VAC (+10%/-15%) 230 VAC (+10%/-15%)
Voltage	12 VDC (-25%/+25%) 24 VDC (-10%/+30%) 24 VAC (+10%/-15%)		
Max. consumption	75 mA for DC / 3,5 VA for AC	180 mA for DC / 5 VA for AC	260 mA for DC / 11 VA for AC
Min. consumption	320 mW for 12/24 VDC	23 mA for 12 VDC / 350 mW for 24 VDC	
Mounting	Snap-on fastener on symmetrical DIN rail EN 50 022	2 holes M4 exterior	4 holes M4 interior
Cable entry		1 plastic cable gland: PG 13,5 cable (ø 8 to 12 mm)	1 plastic cover: PG M16 (ø 5 to 7 mm) 1 plastic cable gland: PG M32 (ø 20 to 26 mm)
Connection to equipment	By spring terminal junction blocks (for cable 2,5 mm ²)		
Indications	1 green indicator light 1 yellow indicator light 1 red indicator light no indication		1 green indicator light 1 green indicator light 1 red indicator light 1 red indicator light
Power supply			
Radio reception			
"Programming" mode			
Per relay output			
Antenna	External by BNC plug	1/4 wave fixed antenna ⁽⁴⁾ or internal ⁽⁵⁾	
Recommended antenna(s) if BNC plug ⁽⁴⁾ :	<p>Outside installation: Antenna VUB084 or antenna VUB086 (possible use of extension with support VUB105/VUB125/VUB131)</p> <p>Installation on vehicle: Antenna VUB084 + extension with support VUB105/VUB125/VUB131 or antenna VUB086 + extension with support VUB105/VUB125/VUB131</p> <p>Installation in plastic cabinet: ORRA and ORRS : antenna VUB084 or antenna VUB086 ORRD : antenna VUB084 + 90° BNC elbow VUB060</p> <p>Installation in metal cabinet: Antenna VUB084 + extension 0,5m VUB170 or antenna VUB086 + extension 0,5m VUB170</p>		

(1) = Supplied programmed on channel No. 17 in standard configuration.

REMINDER: The transmitters radio channel can only be changed on the ORE transmitters equipped with an «on/off» button.

(2) = «On» relay (relay activated by transmitter models having a «on/off» button)

(3) = Different transmitter button numbers and/or different transmitter identity codes

(4) = Plug-in feature possible by BNC plug on industrial receivers, with kit **OWR01**

(5) = Antenna integration possible in industrial receiver housings, with kit **OWR02** (delivered with the receivers). Beware, the range is divided by 2 in this case.

«Din rail» version (ORRD)

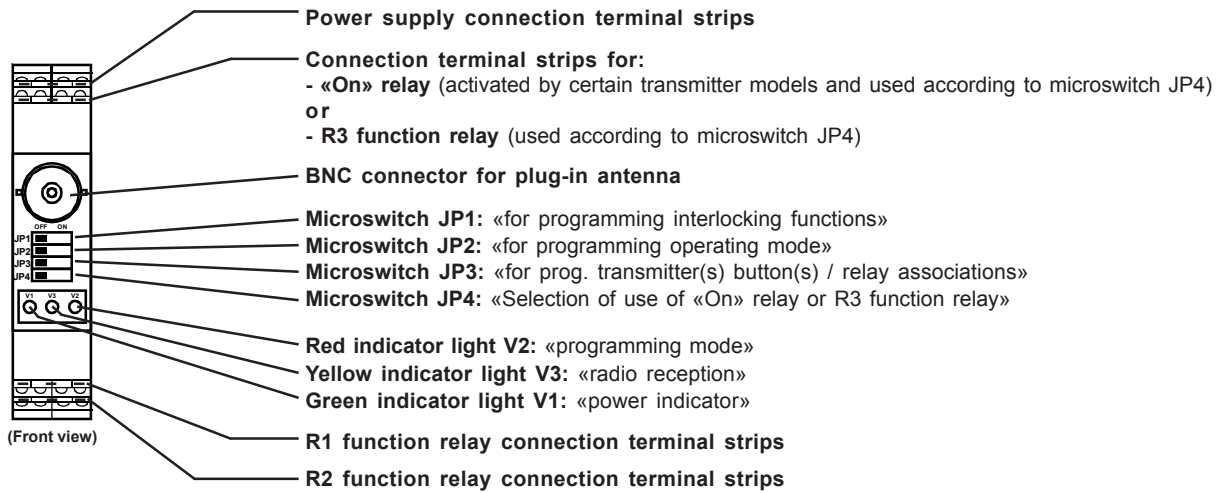

«Industrial small model» version (ORRS)

(i.e.: ORRS42L1U model below)

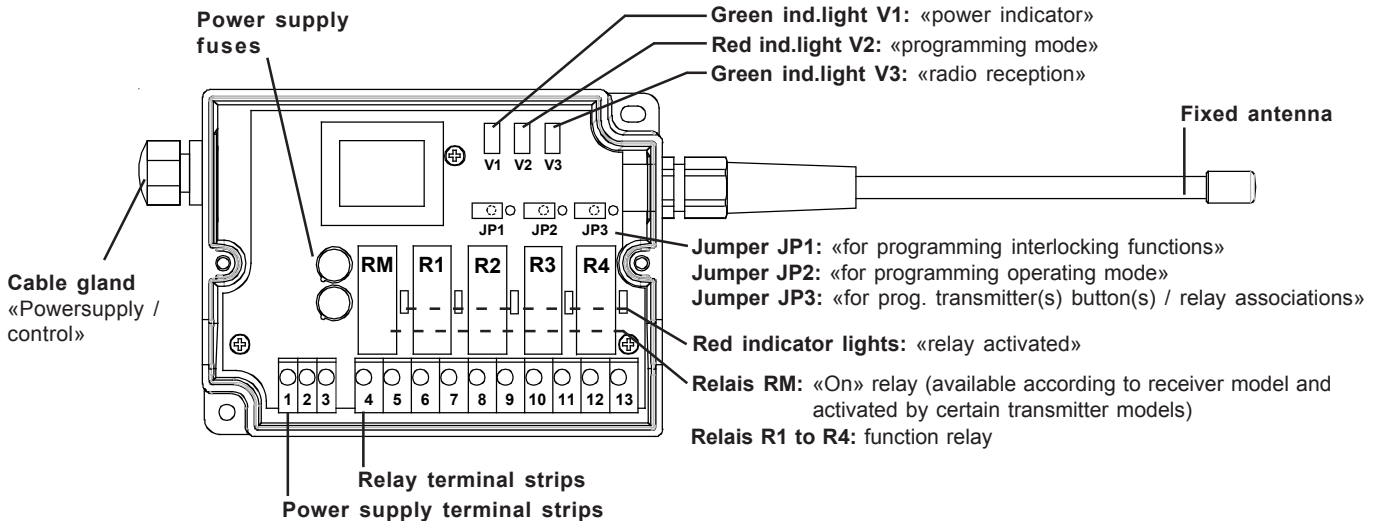

«Industrial large model» version (ORRA)

(i.e.: ORRAH2L1U model below)

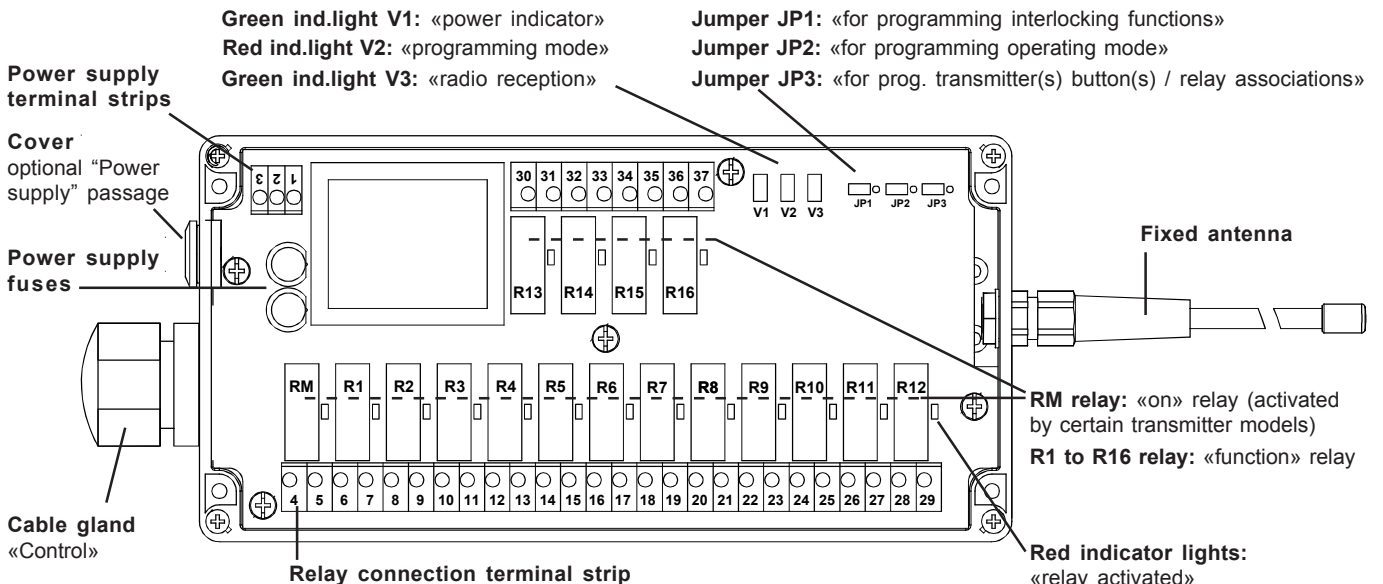

5- Accessories

5.1 Technical characteristics of charger support units (for multifunction transmitters with accumulators)

Power supply	12/24 VDC or 230 VAC
Degree of protection	IP 20
Weight	400 g max.
Output	Voltage 9 VDC Max. current 300 mA
Storage temperature range	-30°C to +70°C
Charging temperature range	0°C to +40°C
Length of adapter cable / connector for multifunction transmitter	1,70m

Charger support
12-24VDC / 9VDC version
(vehicle plug)
Supplied with 3 accumulators



~ 1,70 m

reference: **ORCL1**

Charger support
230VAC / 9VDC version (EU, UK and US plugs)
Supplied with 3 accumulators



reference: **ORCLU**

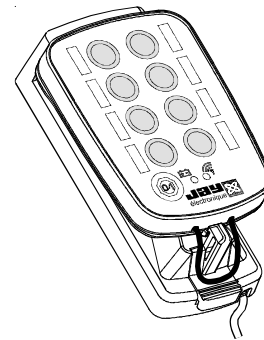

5.2 Orion transmitter function button labels

The various button functions are identified by means of adhesive labels placed in the recesses provided in the transmitter housing at each button location.

The labels are supplied in the form of sheets with the various labels you will need for your application. Simply choose the labels corresponding to your configuration.

Label sheet for standard transmitters (all models), industrial transmitters (all models) and multifunction transmitters (for 4, 6 and 8 button models).

Label sheet for multifunction (12 or 16 buttons) transmitters

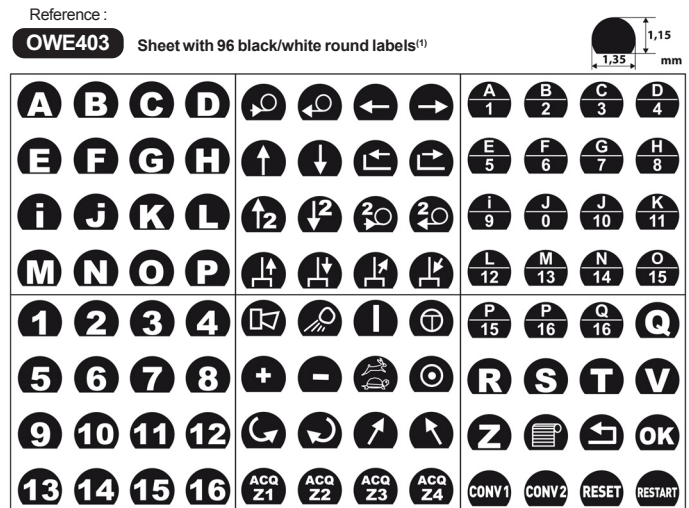
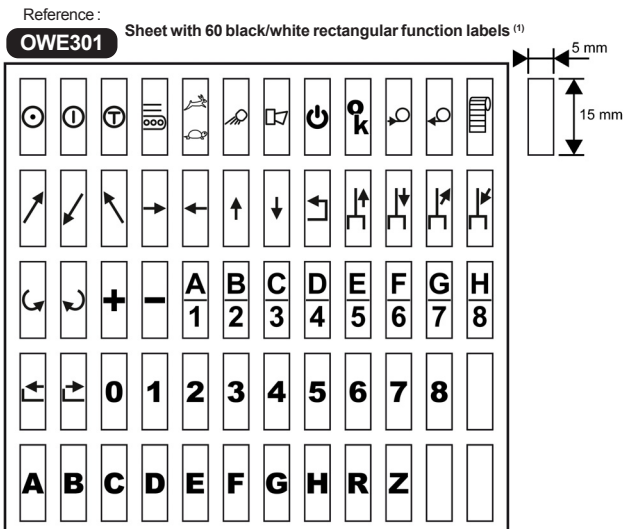

(1) = 1 kit is supplied with the corresponding transmitter

6- Connection diagrams

6.1 Connection diagram for DIN rail receiver model - ORRD

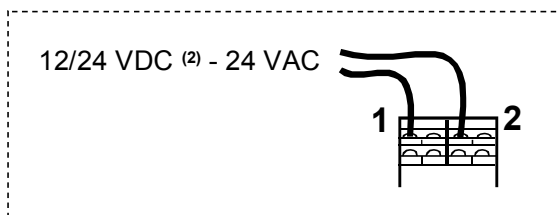
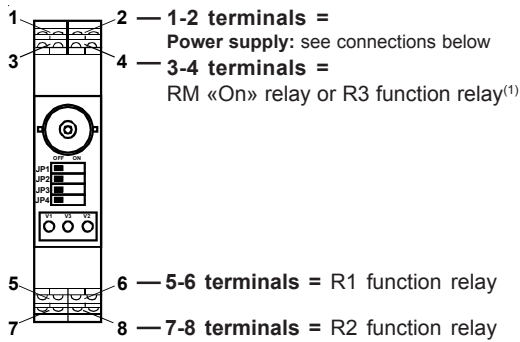

6.2 Connection diagram for Industrial receiver, small model - ORRS

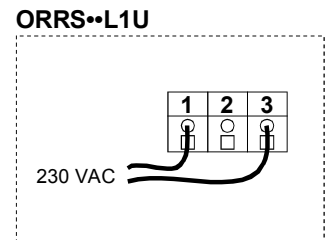
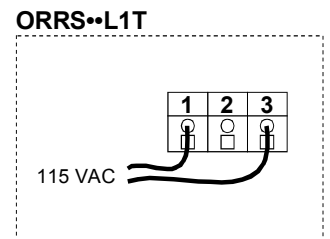
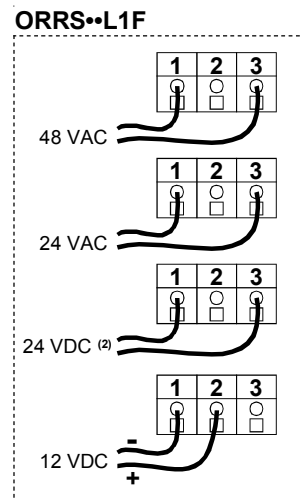
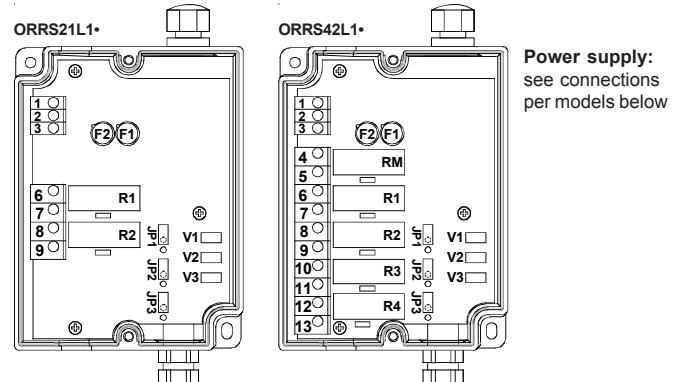

6.3 Connection diagram for Industrial receiver, large model - ORRA

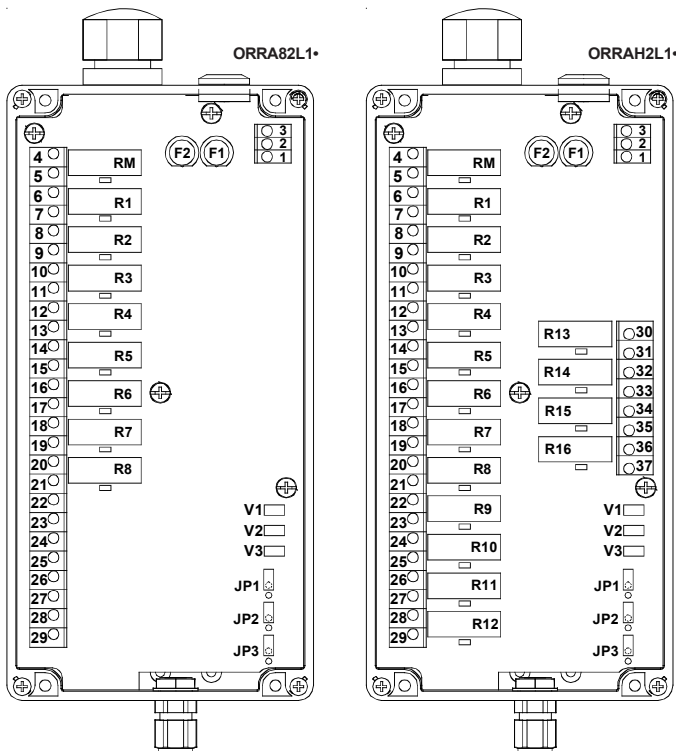

Power supply: see connections per models below

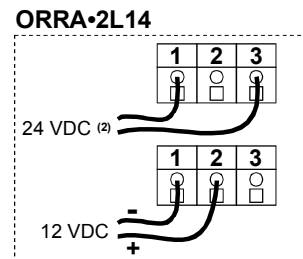
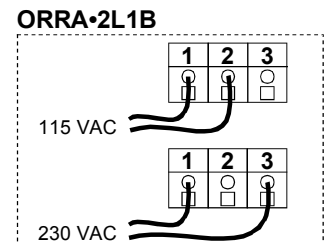
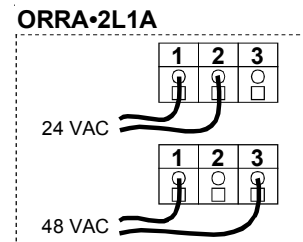

(1) = The relay function can be selected by microswitch
 (2) = No polarity to be respected

7- Dimensions (mm)

7.1 Standard transmitters **ORET**

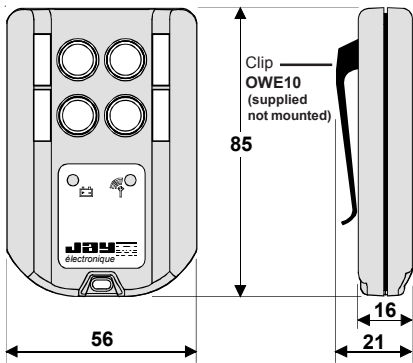

7.2 Industrial transmitters **OREV**

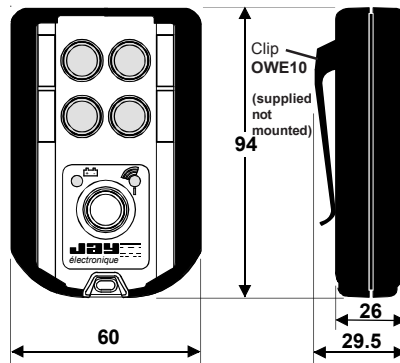

7.3 Multifonction transmitters **OREL**

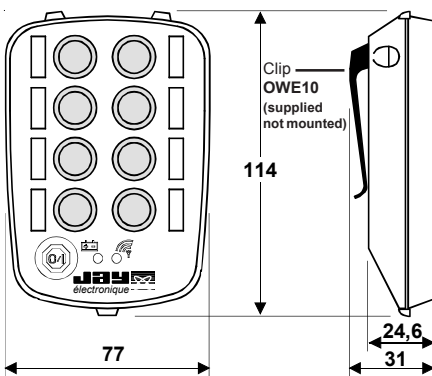

7.4 Wall supports **ORCL** Charger supports **ORCL•**

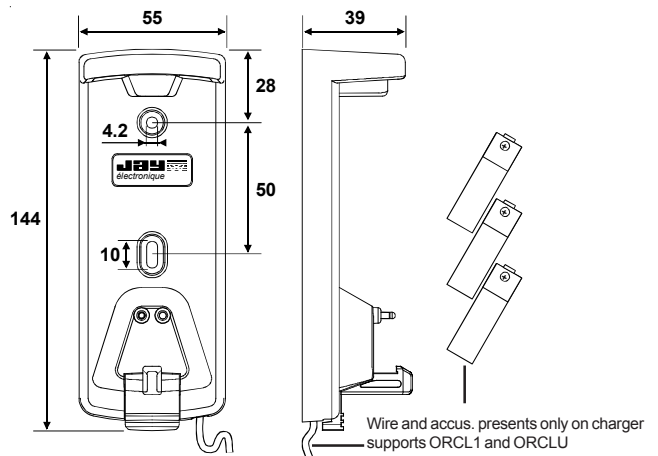

7.5 Industrial receivers «small model» **ORRS**

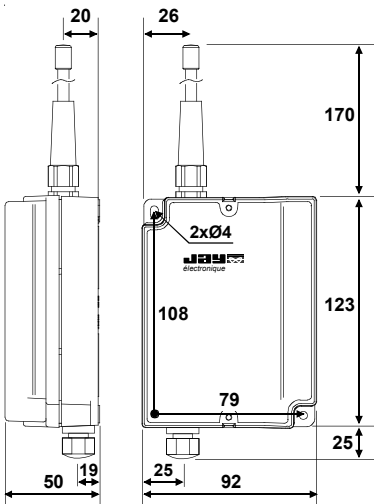

7.6 Industrial receivers «large model» **ORRA**

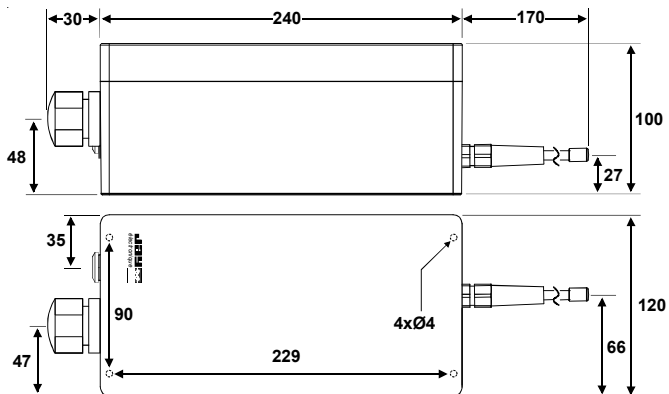

7.7 Receiver on DIN rail **ORRD**

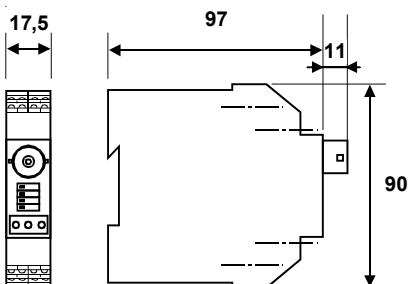

7.8 Accessories

Plug-in antennas
(for receiver **ORRD** on DIN rail or for industrial receivers with kit ref.: **OWR01**)

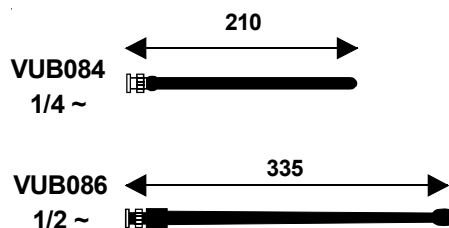



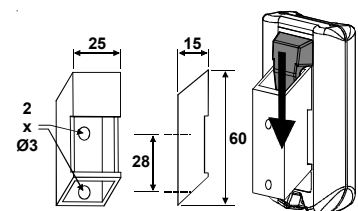









Mounting bracket **OWE01**



8- Selection guide, references for ordering

8.1 Orion transmitters ⁽¹⁾

	Number of function buttons				
	Transmitter model				
	Standard ⁽²⁾	Industrial ⁽²⁾	Industrial ⁽²⁾ + "on/off" button	Multifunction ⁽³⁾	Multifunction ⁽³⁾ + "on/off" button
1	 ORET11SL1				
2	 ORET21SL1	 OREV21SL1	 OREV22SL1		
4	 ORET41SL1	 OREV41SL1	 OREV42SL1		 OREL42SL1
6					 OREL62SL1
8				 OREL81SL1	 OREL82SL1
12					 ORELD2SL1
16				 ORELH1SL1	

(1) = Supplied programmed on channel No. 17 in standard configuration.

REMINDER : The transmitters radio channel can only be changed on the ORE transmitters equipped with an «on/off» button.

(2) = Supplied with 2 AAA batteries.

(3) = Supplied with 3 AAA batteries; can be used with 3 AAA accumulators.

These transmitters, when equipped with AAA accumulators, can be recharged directly on an **ORCL•** charger support. The charger support must be ordered separately.

◆ Accessories for Orion transmitters:

Wall brackets and charger support units

Reference	Designation
OWE01	Mounting support for standard, industrial and multifunction transmitters equipped with carrying clip
ORCL	Mounting support for multifunction transmitter
ORCL1	12-24 VDC (vehicle connector) / 9 VDC charger support unit + 3 accumulators AAA type, for multifunction transmitters (OREL) with accumulators
ORCLU	230 VAC / 9 VDC charger support unit + 3 accumulators AAA type (EU, UK and US plugs), for multifunction transmitters (OREL) with accumulators

Label sheets for function buttons

Reference	Designation
OWE301	60 black/white rectangular function labels for standard, industrial and multifunction transmitters (4, 6 or 8 buttons) ⁽⁴⁾
OWE403	96 black/white round labels for multifunction transmitters (12 or 16 buttons) ⁽⁴⁾

(4) = 1 kit is supplied with the corresponding transmitter.







Miscellaneous accessories

Reference	Designation
OWE10	Carrying clip (on support ref.: OWE01 , belt, pocket ...) ⁽⁵⁾
OWE20	Neck strap
OWE13	Case for standard transmitter (ORET)
OWE14	Case for standard transmitter (ORET) and industrial transmitter (OREV)
OWE30	Protective foam for multifunction transmitter (OREL)
UBWE34	Case for multifunction transmitter (OREL)

(5) = 1 clip (not mounted) is supplied with transmitters.

8- Selection guide, references for ordering (cont.)

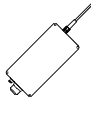
8.2 Orion receivers ⁽¹⁾

Number of function relays	Receiver model / type of power supply						
	DIN rail 12VDC 24VDC 24VAC	Industrial small model 12VDC 24VDC 24VAC 48VAC	Industrial small model 115VAC	Industrial small model 230VAC	Industrial large model 12VDC 24VDC	Industrial large model 24VAC 48VAC	Industrial large model 115VAC 230VAC
							
2		ORRS21L1F	ORRS21L1T	ORRS21L1U			
2 + 1 ⁽²⁾	ORRD22L1C						
3							
4 + 1 ⁽²⁾		ORRS42L1F	ORRS42L1T	ORRS42L1U			
8 + 1 ⁽²⁾					ORRA82L14	ORRA82L1A	ORRA82L1B
16 + 1 ⁽²⁾					ORRAH2L14	ORRAH2L1A	ORRAH2L1B

(1) = Supplied programmed on channel No. 17 in standard configuration.

REMINDER : The transmitters radio channel can only be changed on the ORE transmitters equipped with an «on/off» button.

(2) = «On» relay

◆ Accessories for Orion receivers:

Reference	Designation
OWR01	BNC plug-in antenna kit ⁽³⁾
OWR02	Internal antenna kit ⁽⁴⁾
OWR38	Fastening Kit for ORRS receiver by 2 magnetic contacts (installation on metal surface)
UDWR38	Fastening Kit for ORRA receiver by 4 magnetic contacts (installation on metal surface)
VUB084	1/4 wave antenna straight, 433MHz band, BNC ⁽⁵⁾
VUB086	1/2 wave antenna straight, 433MHz band BNC ⁽⁵⁾
VUB060	90° BNC elbow for antenna VUB084 or BNC antenna extension ^{(3) (6)}
VUB170	0,5 m extension for BNC antenna ⁽⁵⁾
VUB105	2 m extension for BNC antenna + bracket ⁽⁵⁾
VUB125	5 m extension for BNC antenna + bracket ⁽⁵⁾
VUB131	10 m extension for BNC antenna + bracket ⁽⁵⁾

(3) = BNC antenna and BNC extension to be ordered separately.

(4) = 1 kit is supplied with industrial receivers.

(5) = Except for the DIN rail model which comes with a BNC antenna connector as a standard feature, the other receiver models require the plug-in antenna kit Ref.: **OWR01** for use of an antenna or a plug-in antenna extension.

(6) = Not suitable for direct connection to antenna Ref.: **VUB086**; in this case, use an intermediate extension type **VUB1****

The products presented in this document are subject to change. Product descriptions and characteristics are not contractually binding.
Please go to our internet site www.jay-electronique.com to download the most recent updates to our documentation.

E780 F - 1213

JAY
électronique

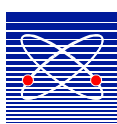

ZAC la Bâtie, rue Champrond
F38334 SAINT ISMIER cedex
☎ +33 (0)4 76 41 44 00 - 📠 +33 (0)4 76 41 44 44
www.jay-electronique.com

Distributor