

# Temperature controllers

## 1/16 DIN - 48 x 48 mm

### gammadue® series M1-M3 lines

#### Flexible, easy and comprehensive

These two 48x48 size controllers of the gammadue® series, are suitable for a wide range of applications.

The M1 can be used as a simple controller while the M3 performs Heat/Cool control and provides on auxiliary current transformer input.

Easy configuration and a simple operating method are merged with the typical characteristics of more complex devices like:

autotune, IP65 front panel protection, serial communications, analogue retransmission output, custom linearisation, transmitter power supply, Start-up and Timer special functions.

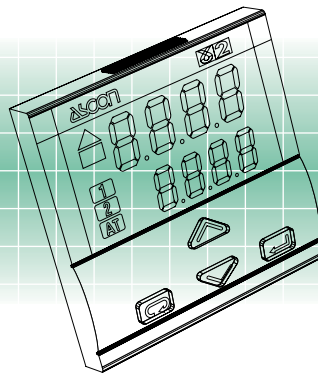
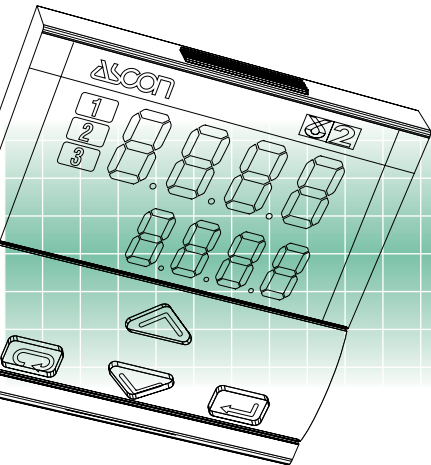
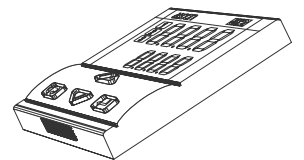

E

ISO 9001 Certified

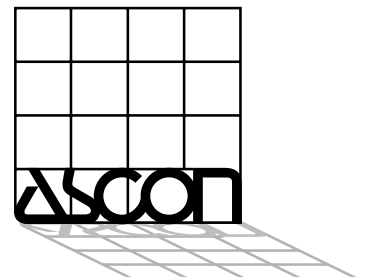

**ASCON spa**

Via Falzarego, 9/11 - 20021 Baranzate - (Milano) Italy - Tel. +39 02 333 371 - Fax +39 02 350 4243

<http://www.ascon.it> e-mail [sales@ascon.it](mailto:sales@ascon.it)

# gammadue®

the right solution to your needs



Your needs	Our solutions
Heaters failure	Heater break alarm with current transformer
Both heating and cooling functions	Heat/Cool double action
Easy replacement and quick start-up	Configuration by simple to use codes
Correct tuning for any condition	Automatic selection between two different tuning methods
Alarm signalling	Absolute, band and deviation alarms, Latching/Blocking
Interfacing with other devices	Serial communications at 9600 baud Modbus/Jbus protocol, analogue retransmission output
Quick learning	Every model has the same operating method
Ergonomic compatibility with other devices	Two colours: beige or darkgrey front panels
Environmental protection	IP65 front panel protection (indoor, dust and water protection)
Easy to use	Ergonomic keypad, clear and comprehensive display
Noise immunity	Electromagnetic compatibility
Universal input signals, linear as well as non-linear	Configurable input (TC, RTD, mA, Volt and ΔT, infrared sensor, "custom" linearisation)
Costs reduction	Built-in Timer and Start-up functions
Reliability and safety	CE compatibility, ASCON is ISO 9001 certified, 3 years warranty
Technical support	Technical application assistance from ASCON sales and after sales service

## Resources

## Operating mode

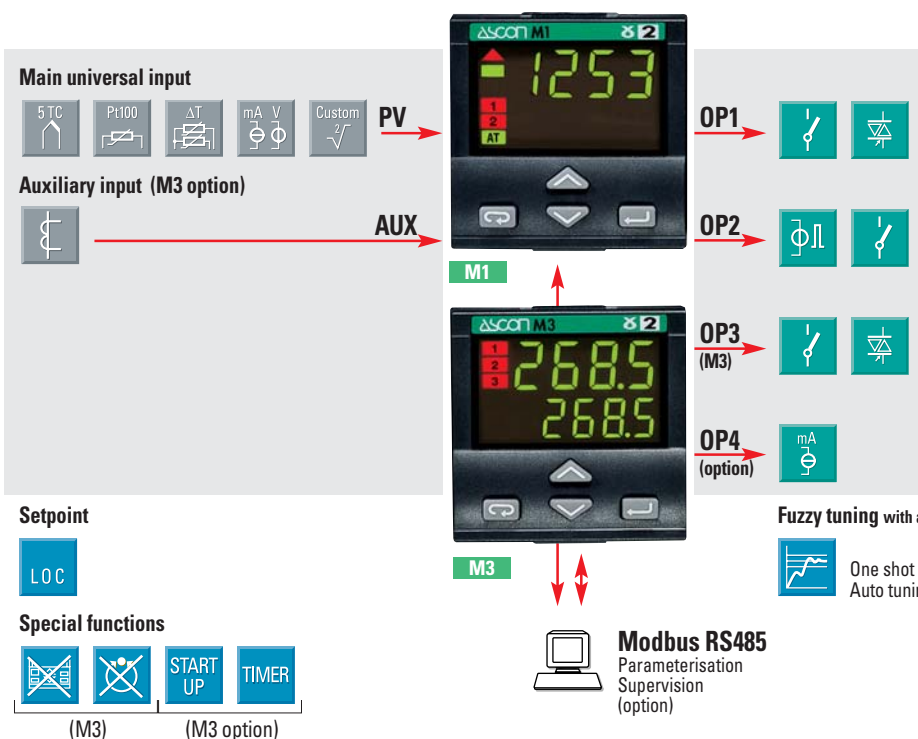

Control	Alarms		Retransmission
	OP1	OP2	OP4
0 Indication only		OP1 OP2	OP4
1 Single action	OP1	OP2 OP3 (M3)	OP4
2 Single action	OP2	OP1 OP3 (M3)	OP4
3 Double action	OP1 OP3	OP2	OP4
4 Double action	OP1 OP2		OP3 OP4
5 Double action	OP2 OP3	OP1	OP4

## Fuzzy tuning with automatic selection



\* Mode 0 for M1 only  
Modes 3, 4 and 5 for M3 only

## Technical data

Features at env. 25°C	Description				
Total configurability	From keypad or serial communications, the user selects: type of input - associated functions and corresponding outputs - type of control algorithm - type of output and safe conditions - alarm types and functionality - control parameter values				
PV input (for signal ranges see table 1)	Common characteristics	A/D converter with 50,000 points Update measurement time: 0.2 s Sampling time: 0.5 s Input shift: -60...+ 60 digit Input filter: 1...30 s (OFF = 0)			
	Accuracy	0.25% ±1 digit (T/C and RTD) 0.1% ±1 digit (mA and mV)	Between 100 and 240Vac error is minimal		
	Resistance thermometer (for ΔT: R1+R2 must be <320Ω)	Pt100Ω at 0°C (IEC 751) °C/°F selectable	2 or 3 wire connection	Line: 20Ω max. (3 wire) Thermal drift 0.35°C/10°C T <sub>env.</sub> <0.35°C/10Ω line res.	
	Thermocouple	L, J, T, K, S, (IEC 584) °C/°F selectable	Internal cold junction compensation	Line: 150Ω max. Thermal drift <2μV/°C T <sub>env.</sub> <5μV/10Ω line res.	
	DC input (current)	0/4...20mA, 2.5Ω ext. shunt R <sub>j</sub> >10MΩ	Engineering units, floating decimal point, configurable	Input drift: <0.1%/20°C T <sub>env.</sub> <5μV/10Ω line res.	
	DC input (voltage)	0/10...50mV, R <sub>j</sub> >10MΩ	Low Range -999...9,999 High Range -999...9,999 100 digits minimum		
Auxiliary input (option)	CT Current transformer (M3 only)	Input 50/100 mA hardware selectable	Current visualization 10...200 A with 1A resolution and Heater break alarm		
Operating modes	M1: 1 single action PID loop or ON/OFF with 1 alarm M3: 1 double action PID loop or ON/OFF with 1 or 2 alarms				
Control mode	Algorithm	PID with overshoot control or ON/OFF			
	Proport. band (P)	0.5...999.9%	PID algorithm		
	Integral time (I)	0.1...100.0 min			
	Derivative time (D)	0.01...10.00 min			
	Error dead band (M3 only)	0.1...10.0 digit			
	Cycle time	1...200 s	For heat/Cool mode (M3 only)		
	Dead band	-10.0...10.0%			
	Relative cool gain	0.1...10.0			
	Cool cycle time	1...200 s			
	Overshoot control	0.01...1.00	PID algorithm		
High limit	100.0...10.0% (heat) -100.0...-10.0% (cool)	ON/OFF algorithm			
Hysteresis	0.1...10.0%				
OP1 output	SPST relay N.O., 2A/250Vac (4A/120Vac) for resistive load Triac, 1A/250Vac for resistive load				
OP2 output	SSR drive not isolated: 5Vdc, ±10%, 30mA max. SPST relay N.O., 2A/250Vac (4A/120Vac) for resistive load				
OP3 output (M3 only)	SPST relay N.O., 2A/250Vac (4A/120Vac) for resistive load Triac, 1A/250Vac for resistive load				
AL1 alarm (indicator with 2 alarms)	Hysteresis 0.1 ... 10.0% of range		M1 only		
	Active high	Absolute threshold, whole range			
	Active low				
AL2, AL3 alarm (M3 only)	Hysteresis 0.1 ... 10.0% of range				
	Action	Active high		Deviation threshold ± range	
		Active low		Action Type	Band threshold 0...range
		Special function		Absolute threshold	whole range
Setpoint	Up and down ramps	0.1...999.9 digit/min (OFF = 0)			
	Low limit	from low range to high limit			
	High limit	from low limit to high range			
OP4 (option) PV or SP retransm. output	Galvanically isolated: Resolution: Accuracy:	500Vac/1min 12bit (0.025%) 0.1%	In current 0/4...20mA 750Ω/15V max.		
One-shot Fuzzy-Tuning	Depending on the process condition, the controller applies the best method		Step response		
			Natural frequency		

Input type	Scale range
RTD	-99.9...300.0 °C
	-99.9...572.0 °F
Pt100Ω a 0°C	-200...600 °C
	-328...1112 °F
T/C type L	0...600 °C
Fe-Const.	32...1112 °F
T/C type J	0...600 °C
Fe-Cu 45% Ni	32...1112 °F
T/C type T	-200...400 °C
Cu - CuNi	-328...752 °F
T/C type K	0...1200 °C
Chromel Alumel	32...2192 °F
T/C type S	0...1600 °C
Pt10%Rh-Pt	32...2912 °F
0/4...20 mA	Configurable engineering units
0/10...50 mV	mA, mV, V, bar, psi, Rh, ph
mV Custom scale	On request

Table 1 : PV input

## Special functions

To improve the instrument performance and to reduce the wiring and installation costs, two special functions are available:

### - Start-up

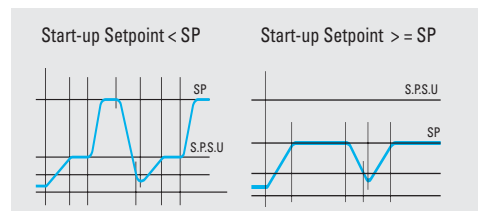

### - Timer

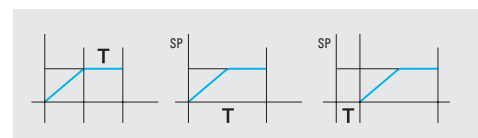

The use of these functions avoids additional device installation (e.g. external timer), therefore allowing a significant costs reduction.

Moreover there are:

- **Keypad lock/unlock** function, to avoid incorrect operator actions
- **Outputs lock/unlock** function, at any moment it is possible to stop the control action, but not the process variable display, without switching-off the power supply.

## Technical data

Features at env. 25°C	Description	
Ser. comm.s (opt.)	RS 485 isolated, Modbus/Jbus protocol 1,200, 2,400, 4,800, 9,600 bit/s, three wires	
Auxiliary power supply (option)	+18Vdc ±20%, 30 mA max. to supply an external transmitter	
Operational safety	Measure input	Detection of out of range, short circuit or sensor break with automatic activation of the safety strategies and alerts on display
	Control output	Safety value (user enabled/disabled): 0%, 100% (M1) 0...100% (-100...100% for Heat/Cool mode) (M3).
	Parameters	A non volatile memory stores for unlimited time all the parameter and configuration values
	Password	A password protects the access to the instrument configuration and parameters
General characteristics	Power supply (PTC protected)	100...240Vac (-15...+10%) 50/60Hz or 24Vdc (-25...+12%), 50/60Hz and 24Vdc (-15...+25%). Power consumption 2.6W max.
	Safety	Compliance EN61010-1 (IEC 1010-1), installation class 2 (2.5kV), pollution class 2, class II instrument
	Electromagnetic compatibility	Compliance to the CE standards for industrial system and equipment
	UL and cUL approval	File E176452
	Protection EN60529 (IEC529)	IP65 front panel
	Overall dimensions	1/16 DIN - 48 x 48, depth 120 mm, weight 130g approx. Panel cut-out: 45 <sup>+0.6</sup> x 45 <sup>+0.6</sup> mm

## Electrical wirings

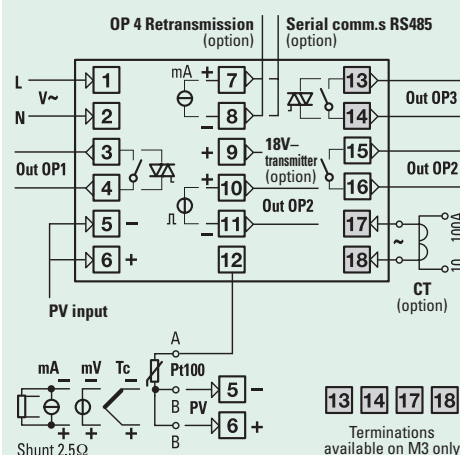

## Ordering codes

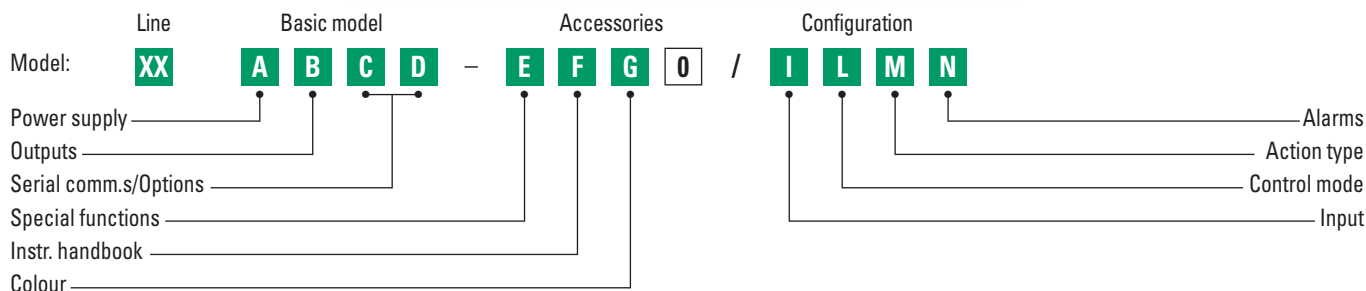

Line		M1	M3	C	D	
Controller-Indicator 48x48x120					<b>XX</b>	
Heat/Cool Controller 48x48x120					<b>M1</b>	
Power supply					<b>M3</b>	
100...240Vac (-15...+10%)					<b>A</b>	
24Vac (-25...+12%) or 24Vdc (-15...+25%)					<b>3</b>	
OP1 (OP3) output		<b>M1</b>	<b>M3</b>	<b>B</b>		
Relay		✓			<b>0</b>	
Relay-Relay			✓		<b>1</b>	
Relay-Triac			✓		<b>2</b>	
Triac		✓			<b>3</b>	
Triac-Relay			✓		<b>4</b>	
Triac-Triac			✓		<b>5</b>	
Serial comm.s	Options	<b>M1</b>	<b>M3</b>	<b>C</b>	<b>D</b>	
Not fitted	None	✓	✓	<b>0</b>	<b>0</b>	
	Current Transformer input (CT)		✓	<b>0</b>	<b>3</b>	
	Transmitter power supply +18Vdc	+ Retransmission	✓	✓	<b>0</b>	<b>6</b>
		+ CT	✓	✓	<b>0</b>	<b>7</b>
		+ Retrans. + CT	✓	✓	<b>0</b>	<b>8</b>
RS 485	None	✓	✓	<b>5</b>	<b>0</b>	
Modbus/Jbus protocol	Transmitter power supply + CT	✓	✓	<b>5</b>	<b>6</b>	
		✓	✓	<b>5</b>	<b>8</b>	
Special functions		<b>M1</b>	<b>M3</b>	<b>E</b>		
Not fitted		✓	✓	<b>0</b>		
Start-up + Timer			✓	<b>2</b>		
Instruction handbook					<b>F</b>	
Italian-English (std)					<b>0</b>	
French-English					<b>1</b>	
German-English					<b>2</b>	
Spanish-English					<b>3</b>	
Front case colour					<b>G</b>	
Dark (std)					<b>0</b>	
Beige					<b>1</b>	

Input type	Range scale			<b>I</b>
RTD Pt100 IEC751	-99.9...300.0 °C	-99.9...572.0 °F		<b>0</b>
RTD Pt100 IEC751	-200...600 °C	-328...1112 °F		<b>1</b>
TC L Fe-Const DIN43710	0...600 °C	32...1112 °F		<b>2</b>
TC J Fe-Cu45% Ni IEC584	0...600 °C	32...1112 °F		<b>3</b>
TC T Cu-CuNi	-200...400 °C	-328...752 °F		<b>4</b>
TC K Chrome1-Alumel IEC584	0...1200 °C	32...2192 °F		<b>5</b>
TC S Pt10%Rh-Pt IEC584	0...1600 °C	32...2912 °F		<b>6</b>
0...50mV linear	Engineering units			<b>7</b>
10...50mV linear	Engineering units			<b>8</b>
mV "Custom" scale	On request			<b>9</b>
Output configuration		<b>M1</b>	<b>M3</b>	<b>L</b>
PID	control OP1 / alarm AL2 on OP2	✓	✓	<b>0</b>
	control OP2 / alarm AL2 on OP1	✓	✓	<b>1</b>
On - Off	control OP1 / alarm AL2 on OP2	✓	✓	<b>2</b>
	control OP2 / alarm AL2 on OP1	✓	✓	<b>3</b>
Indicator with 2 alarms	alarm AL1 on OP1 / alarm AL2 on OP2	✓		<b>4</b>
	alarm AL1 on OP2 / alarm AL2 on OP1	✓		<b>5</b>
Heat / Cool action	control OP1-OP3 / alarm AL2 on OP2		✓	<b>6</b>
	control OP1-OP2 / alarm AL2 on OP3		✓	<b>7</b>
	control OP2-OP3 / alarm AL2 on OP1		✓	<b>8</b>
Single control action type	Heat/Cool (M3)	<b>M1</b>	<b>M3</b>	<b>M</b>
Reverse (M1: AL1 active low)	Linear cool	0%	✓	<b>0</b>
Direct (M1: AL1 active high)	On-Off cool	0%	✓	<b>1</b>
Reverse (AL1 active low)		100%	✓	<b>2</b>
Direct (AL1 active high)		100%	✓	<b>3</b>
AL2 type and function		<b>M1</b>	<b>M3</b>	<b>N</b>
Disabled		✓	✓	<b>0</b>
Sensor break/Loop break (M3) alarm		✓	✓	<b>1</b>
Absolute	active high	✓	✓	<b>2</b>
	active low	✓	✓	<b>3</b>
Deviation	active high	✓	✓	<b>4</b>
	active low	✓	✓	<b>5</b>
Band	active out	✓	✓	<b>6</b>
	active in	✓	✓	<b>7</b>
Heater break by CT (if present)	active during ON output state		✓	<b>8</b>
	active during OFF output state		✓	<b>9</b>

If not differently specified the controller will be supplied with standard version

Model: M1 3000-0000 or M3 3100-0000