



Power analyzer

CVM-C5-ITF-485

CVM-C5-MC-485

CVM-C5-mV-485



INSTRUCTION MANUAL

(M026B01-03-19A)



SAFETY PRECAUTIONS

Follow the warnings described in this manual with the symbols shown below.

	<p>DANGER Warns of a risk, which could result in personal injury or material damage.</p>
---	---

	<p>ATTENTION Indicates that special attention should be paid to a specific point.</p>
---	--

If you must handle the unit for its installation, start-up or maintenance, the following should be taken into consideration:

	<p>Incorrect handling or installation of the unit may result in injury to personnel as well as damage to the unit. In particular, handling with voltages applied may result in electric shock, which may cause death or serious injury to personnel. Defective installation or maintenance may also lead to the risk of fire. Read the manual carefully prior to connecting the unit. Follow all installation and maintenance instructions throughout the unit's working life. Pay special attention to the installation standards of the National Electrical Code.</p>
---	---

	<p>Refer to the instruction manual before using the unit In this manual, if the instructions marked with this symbol are not respected or carried out correctly, it can result in injury or damage to the unit and /or installations.</p>
---	--

CIRCUTOR, SA reserves the right to modify features or the product manual without prior notification.

DISCLAIMER

CIRCUTOR, SA reserves the right to make modifications to the device or the unit specifications set out in this instruction manual without prior notice.

CIRCUTOR, SA on its web site, supplies its customers with the latest versions of the device specifications and the most updated manuals.

www.circutor.com



CONTENTS

SAFETY PRECAUTIONS	3
DISCLAIMER	3
CONTENTS	4
REVISION LOG.....	6
1.- VERIFICATION UPON RECEPTION	7
2.- PRODUCT DESCRIPTION	7
3.- UNIT INSTALLATION	8
3.1.- PRIOR RECOMMENDATIONS.....	8
3.2.- INSTALLATION	8
3.3.- UNIT TERMINALS.....	9
3.3.1.- MODEL CVM-C5-xxx-485-C	9
3.3.2.- MODEL CVM-C5-xxx-485-I.....	10
3.4.- CONNECTION DIAGRAMS	11
3.4.1.- THREE-PHASE NETWORK MEASURING WITH A 4-WIRE CONNECTION, MODEL CVM-C5-IFF-485 and CVM-C5-mV-485.....	11
3.4.2.- THREE-PHASE NETWORK MEASURING WITH A 4-WIRE CONNECTION, MODEL CVM-C5-MC-485.....	12
3.4.3.- THREE-PHASE NETWORK MEASURING WITH A 3-WIRE CONNECTION, MODELS CVM-C5-ITF-485 AND CVM-C5-mV-485.	13
3.4.4.- THREE-PHASE NETWORK MEASURING WITH A 3-WIRE CONNECTION, MODEL CVM-C5-MC-485.....	14
3.4.5.- THREE-PHASE NETWORK MEASURING WITH A 3-WIRE CONNECTION AND TRANSFORMERS IN AN ARON CONNECTION.....	15
3.4.6.- TWO-PHASE NETWORK MEASURING WITH A 3-WIRE CONNECTION.	16
3.4.7.- PHASE-TO-PHASE SINGLE-PHASE NETWORK MEASURING WITH A 2-WIRE CONNECTION.	17
3.4.8.- PHASE-TO-NEUTRAL SINGLE-PHASE NETWORK MEASURING WITH A 2-WIRE CONNECTION	18
4.- OPERATION	19
4.1.- MEASURING PARAMETERS	19
4.2.- KEYBOARD FUNCTIONS.....	20
4.3.- DISPLAY	21
4.3.1. CONSUMPTION DATA AREA.....	21
4.3.2. INSTANTANEOUS DATA AREA.....	24
4.4.- TARIFFS	27
4.5.- DIGITAL OUTPUT (MODEL CVM-C5-xxx-RS485-C)	27
4.6.- PROGRAMMING	28
4.6.1. PRIMARY VOLTAGE	28
4.6.2. SECONDARY VOLTAGE.....	29
4.6.3. PRIMARY CURRENT	29
4.6.4. SECONDARY CURRENT (<i>ONLY THE MODEL CVM-C5-ITF-485</i>).....	30
4.6.5. MEASUREMENT SYSTEM	30
4.6.6. RATIO OF KGCO ₂ CARBON EMISSIONS FOR TARIFF 1	31
4.6.7. COST RATIO FOR TARIFF 1	31
4.6.8. RATIO OF KGCO ₂ CARBON EMISSIONS FOR TARIFF 2	32
4.6.9. COST RATIO FOR TARIFF 2	32
4.6.10. MAXIMUM DEMAND VARIABLE.....	33
4.6.11. PERIOD OF MAXIMUM DEMAND INTEGRATION.....	33
4.6.12. DELETING MAXIMUM DEMAND.....	34
4.6.13. DEFAULT SCREEN	34
4.6.14. DISPLAY BACKLIGHT	34
4.6.15. PROGRAMMING THE DIGITAL OUTPUT (MODEL CVM-C-xxx-RS485-C).....	35
4.6.16. DELETING ENERGY METERS	39
4.6.17. DELETING MAXIMUM AND MINIMUM VALUES	39
4.6.18. MODBUS COMMUNICATIONS : DEFAULT PARAMETERS	39
4.6.19. MODBUS COMMUNICATIONS : PERIPHERAL NUMBER.....	39
4.6.20. MODBUS COMMUNICATIONS : TRANSMISSION SPEED.....	40
4.6.21. MODBUS COMMUNICATIONS : PARITY.....	40
4.6.22. MODBUS COMMUNICATIONS : NUMBER OF DATA BITS	40

4.6.23. MODBUS COMMUNICATIONS : NUMBER OF STOP BITS	41
4.6.24. LOCKING THE PROGRAMMING	41
4.6.25. PASSWORD	41
4.7.- COMMUNICATIONS.....	42
4.7.1. CONNECTIONS	42
4.7.2. PROTOCOL	43
4.7.3. EXEMPLE MODBUS QUESTION	46
5.- TECHNICAL FEATURES	47
6.- MAINTENANCE AND TECHNICAL SERVICE.....	49
7.- GUARANTEE.....	49
8.- CE CERTIFICATE.....	50

REVISION LOG

Table 1: Revision log.

Date	Revision	Description
12/15	M026B01-03-15A	Initial Version
01/16	M026B01-03-16A	Changes in the following sections: 4.- 4.6.15.- 4.7.2.2.
03/16	M026B01-03-16B	Changes in the following sections: 3.2.- 5.
05/16	M026B01-03-16C	Changes in the following sections: 4.6.15.- 8.
09/16	M026B01-03-16D	Changes in the following sections: 2.-4.1-4.6.1
03/18	M026B01-03-18A	Changes in the following sections: 4.6.15. - 8
02/19	M026B01-03-19A	Changes in the following sections: 5.

Note : Device images are for illustrative purposes only and may differ from the actual device.

1.- VERIFICATION UPON RECEPTION

Check the following points when you receive the device:

- a) The device meets the specifications described in your order.
- b) The device has not suffered any damage during transport.
- c) Perform an external visual inspection of the device prior to switching it on.
- d) Check that it has been delivered with the following:
 - An installation guide,
 - 2 Retainers for subsequent attachment of the device



If any problem is noticed upon reception, immediately contact the transport company and/or **CIRCUTOR's** after-sales service.

2.- PRODUCT DESCRIPTION

The **CVM-C5-xxx-485** device measures, calculates and displays the main electrical parameters of the following low voltage networks: single-phase, two-phase, with and without neutral, balanced three-phase, with ARON measurements or unbalanced. The measurement will be taken in RMS with the three AC voltage inputs and three current inputs.

There are 3 versions of the team based on the current input:

- ✓ **CVM-C5-ITF-485**, indirect measure current with transformers /5A and /1A.
- ✓ **CVM-C5-MC-485**, indirect measure current with efficient transformers series MC1 and MC3.
- ✓ **CVM-C5-mV-485**, indirect measure current with transformers /0.333V.



The device features:

- **3 keys** that allow you to browse between the various screens and program the device.
- **LCD Display** to display all the parameters,
- **1 digital input** to select the tariff (Model **CVM-C5-xxx-485-I**).
- **1 programmable digital output** to act as a pulse or alarm output.
(Model **CVM-C5-xxx-485-C**)
- **RS-485 communications**, MODBUS RTU©.

3.- UNIT INSTALLATION

3.1.- PRIOR RECOMMENDATIONS



In order to use the device safely, it is critical that individuals who handle it follow the safety measures described in the standards of the country where it is being used, use the necessary personal protective equipment, and pay attention to the various warnings indicated in this instruction manual.

The **CVM-C5** device must be installed by authorised and qualified staff.

The power supply plug must be disconnected and measuring systems switched off before handling, altering the connections or replacing the device. It is dangerous to handle the device while it is powered.

Also, it is critical to keep the cables in perfect condition in order to avoid accidents, personal injury and damage to installations.

The manufacturer of the device is not responsible for any damage resulting from failure by the user or installer to heed the warnings and/or recommendations set out in this manual, nor for damage resulting from the use of non-original products or accessories or those made by other manufacturers.

In the event an anomaly or malfunction is detected in the device, refrain from using it to take any measurements.

Inspect the work area before taking any measurements. Do not take measurements in dangerous areas or where there is a risk of explosion.



Disconnect the device from the power supply (device and measuring system power supply) before maintaining, repairing or handling the device's connections. Please contact the after-sales service if you suspect that there is an operational fault in the device.

3.2.- INSTALLATION

The device will be installed on a panel ($92^{+0.8} \times 92^{+0.8}$ mm panel drill hole, in compliance with DIN 43700). All connections are located inside the electric panel.



Terminals, opening covers or removing elements can expose parts that are hazardous to the touch while the device is powered. Do not use the device until it is fully installed.

The device must be connected to a power circuit that is protected with gl (IEC 269) or M type fuses with a rating of 0.5 to 2 A. It must be fitted with a circuit breaker or equivalent device, in order to be able to disconnect the device from the power supply network.

The power and voltage measuring circuit must be connected with cables that have a minimum cross-section of 1mm².

The secondary line of the current transformer will have a minimum cross-section of 2.5 mm².

The temperature rating of insulation of wires connected to the device will be at minimum 62°C.

3.3.- UNIT TERMINALS

3.3.1.- MODEL CVM-C5-xxx-485-C

Table 2: List of CVM-C5-xxx-485-C terminals.

Device terminals	
1 : Auxiliary Power Supply	10: V _{L3} , L3 voltage input
2: Auxiliary Power Supply	11: N, neutral
3: SO+, Transistor output	12: S ₁ , L1 current input
4: SO-, Transistor output	13: S ₂ , L1 current input
5: A(+), RS485	14: S ₂ , L1 current input
6: B(-), RS485	15: S ₂ , L2 current input
7: GND, for RS485	16: S ₁ , L3 current input
8: V _{L1} , L1 voltage input	17: S ₂ , L3 current input
9: V _{L2} , L2 voltage input	

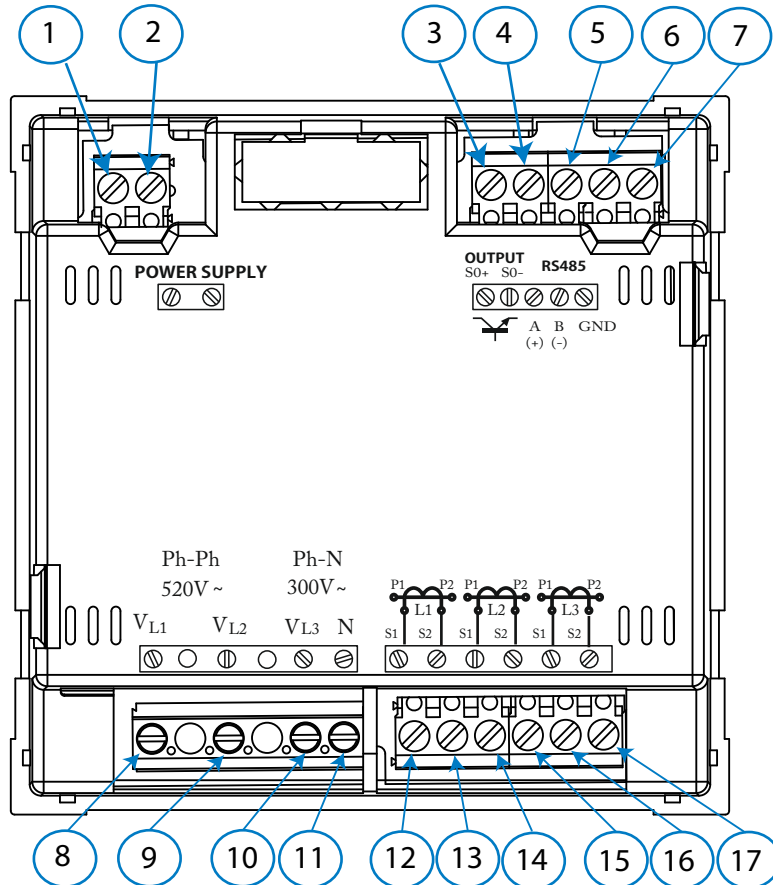

Figure 1: CVM-C5-xxx-485-C terminals.

3.3.2.- MODEL CVM-C5-xxx-485-I

Table 3:List of CVM-C5-xxx-485-I terminals.

Device terminals	
1 : Auxiliary Power Supply	10: V_{L3} , L3 voltage input
2: Auxiliary Power Supply	11: N, neutral
3: Digital input	12: S_1 , L1 current input
4: Digital input	13: S_2 , L1 current input
5: A(+), RS485	14: S_2 , L1 current input
6: B(-), RS485	15: S_2 , L2 current input
7: GND, for RS485	16: S_1 , L3 current input
8: V_{L1} , L1 voltage input	17: S_2 , L3 current input
9: V_{L2} , L2 voltage input	

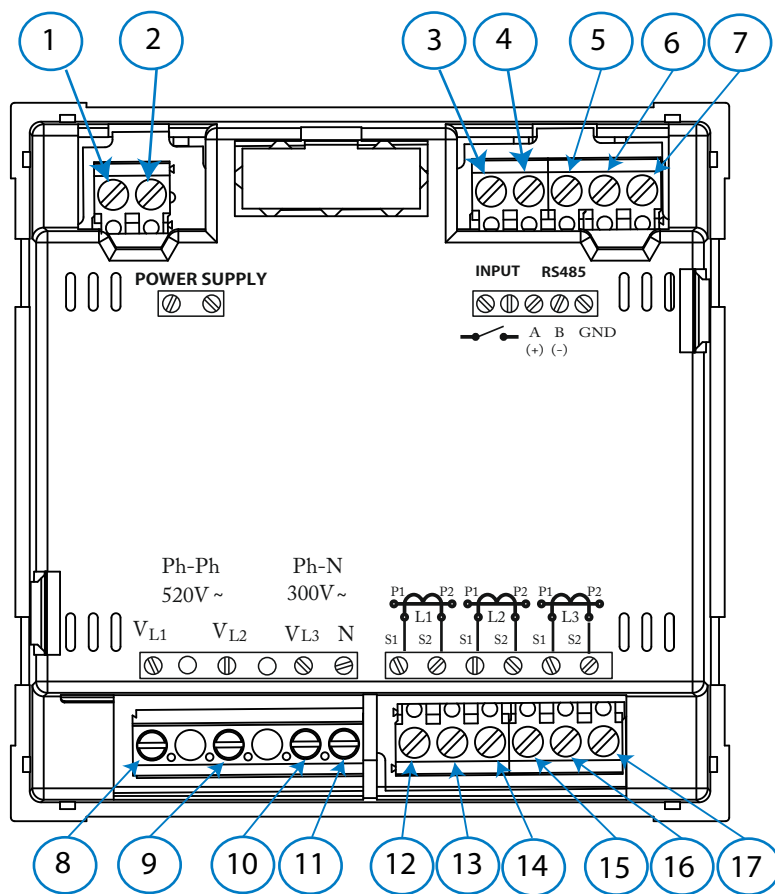

Figure 2: CVM-C5-xxx-485-I terminals.

3.4.- CONNECTION DIAGRAMS

3.4.1.- THREE-PHASE NETWORK MEASURING WITH A 4-WIRE CONNECTION, MODEL CVM-C5-IF-485 AND CVM-C5-mV-485.

Measurement system: 4 - 3Ph

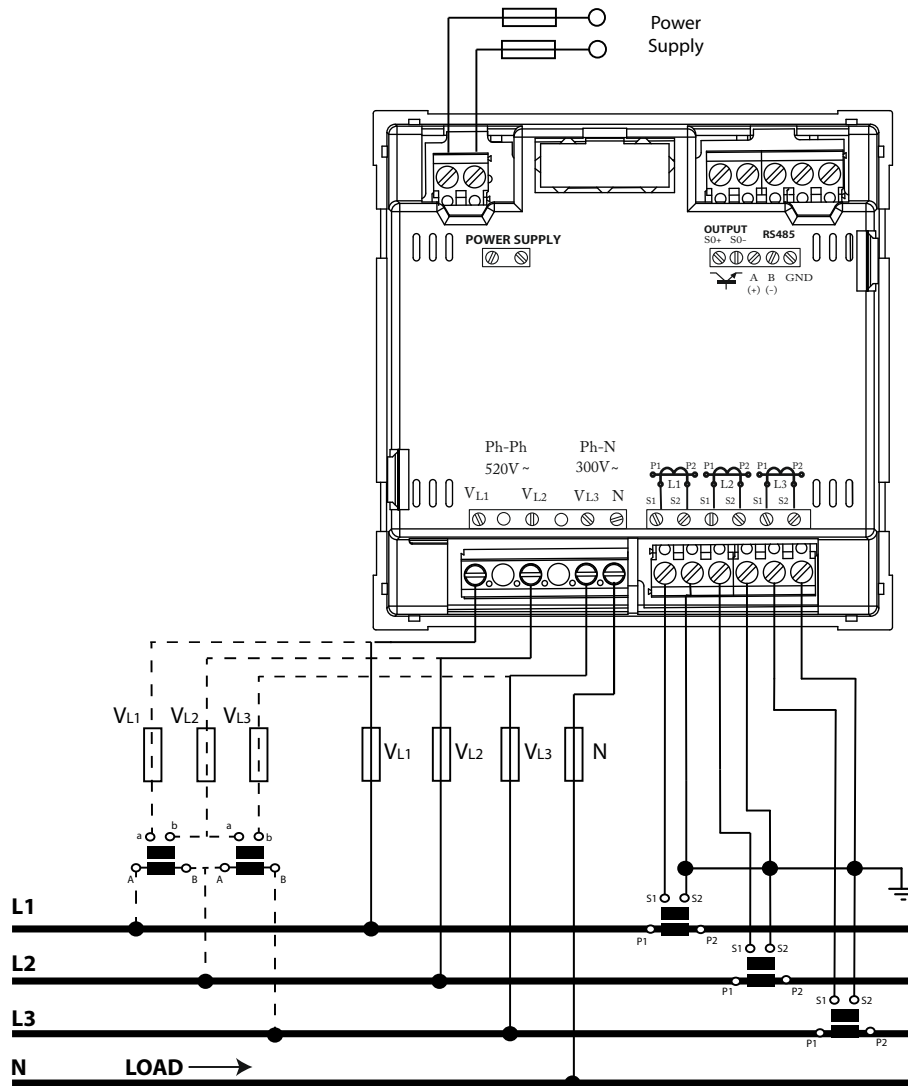

Figure 3: Three-phase measuring with a 4-wire connection, model CVM-C5-ITF-485 and CVM-C5-mV-485.

3.4.2.- THREE-PHASE NETWORK MEASURING WITH A 4-WIRE CONNECTION, MODEL CVM-C5-MC-485

Measurement system : *4-3Ph*

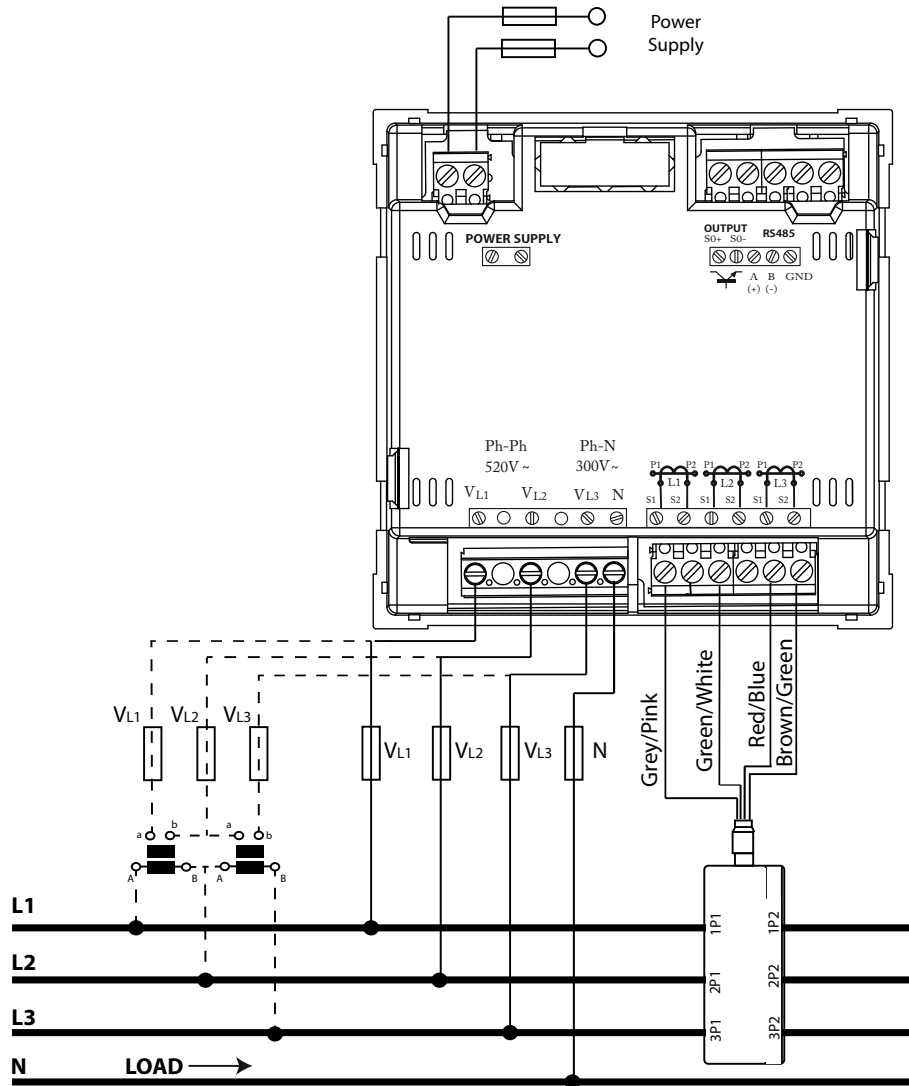

Figure 4: Three-phase measuring with a 4-wire connection, model CVM-C5-MC-485.

3.4.3.- THREE-PHASE NETWORK MEASURING WITH A 3-WIRE CONNECTION, MODELS CVM-C5-ITF-485 AND CVM-C5-mV-485.

Measurement system: 3 - 3Ph

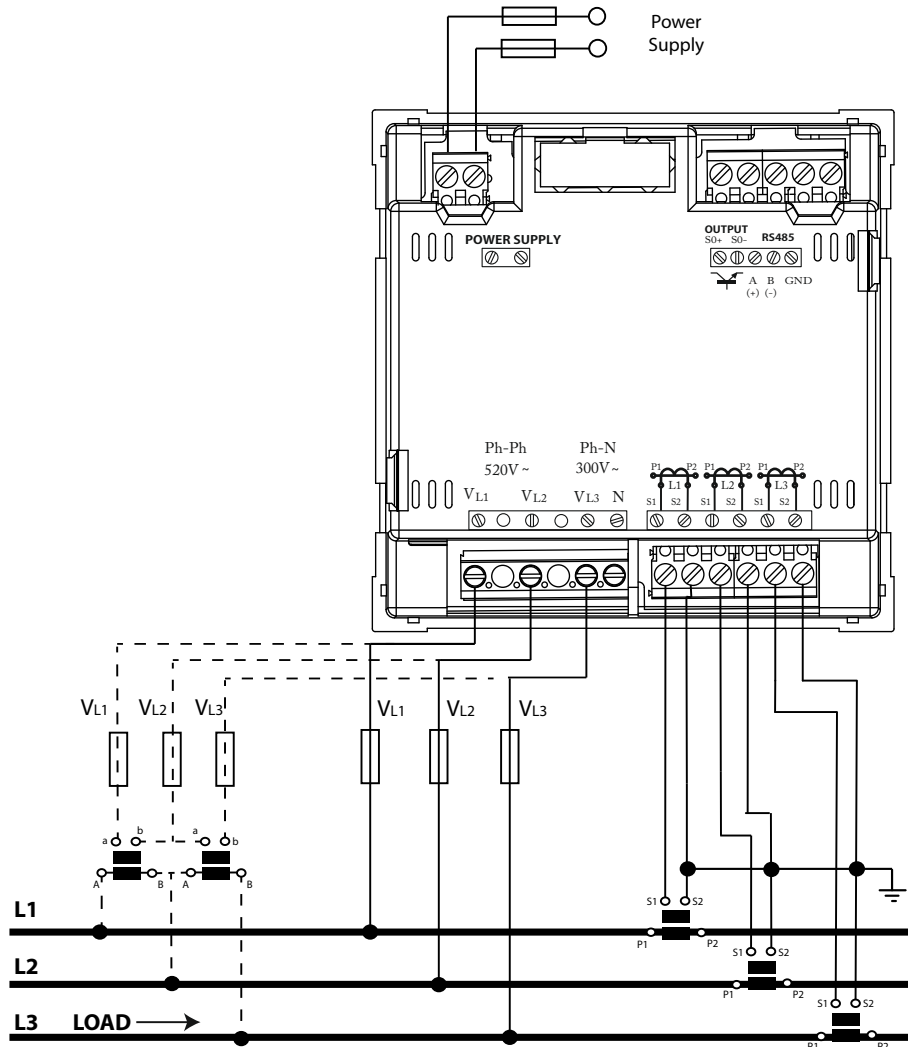

Figure 5: Three-phase measuring with a 3-wire connection, models CVM-C5-ITF-485 and CVM-C5-mV-485.

3.4.4.- THREE-PHASE NETWORK MEASURING WITH A 3-WIRE CONNECTION , MODEL CVM-C5-MC-485.

Measurement system: *3 - 3Ph*

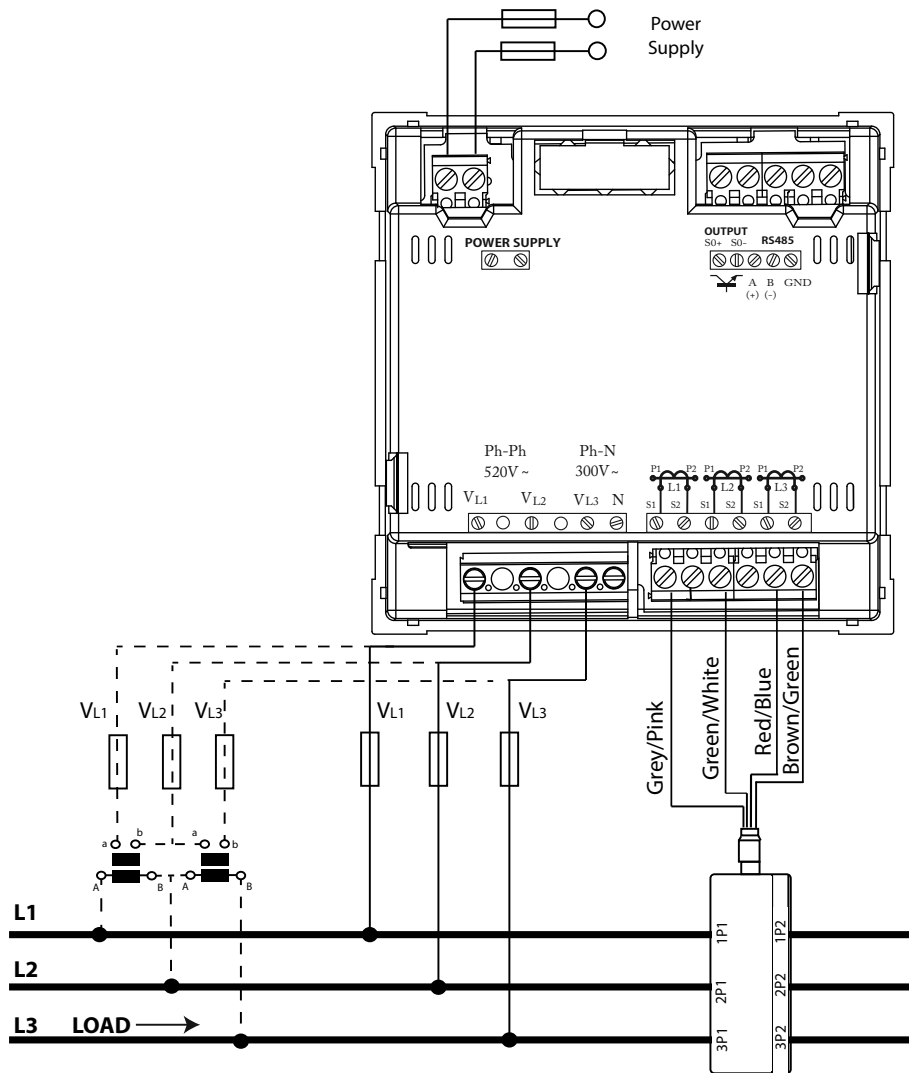

Figure 6: Three-phase network measuring with a 3-wire connection, modelo CVM-C5-MC-485.

3.4.5.- THREE-PHASE NETWORK MEASURING WITH A 3-WIRE CONNECTION AND TRANSFORMERS IN AN ARON CONNECTION.

Measurement system: *3-A-0N*

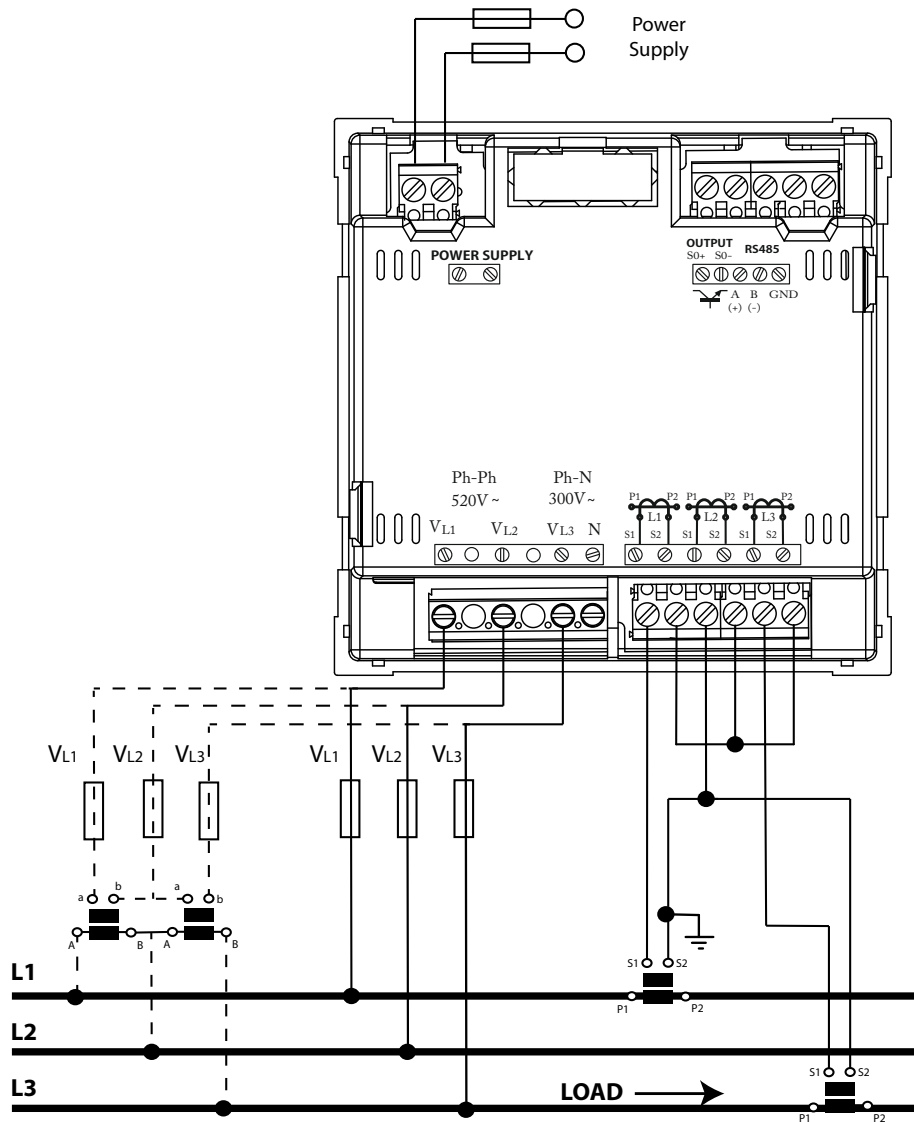

Figure 7: Three-phase measuring with a 3-wire connection and transformers in an ARON connection.

3.4.6.- TWO-PHASE NETWORK MEASURING WITH A 3-WIRE CONNECTION.

Measurement system: 3-2Ph

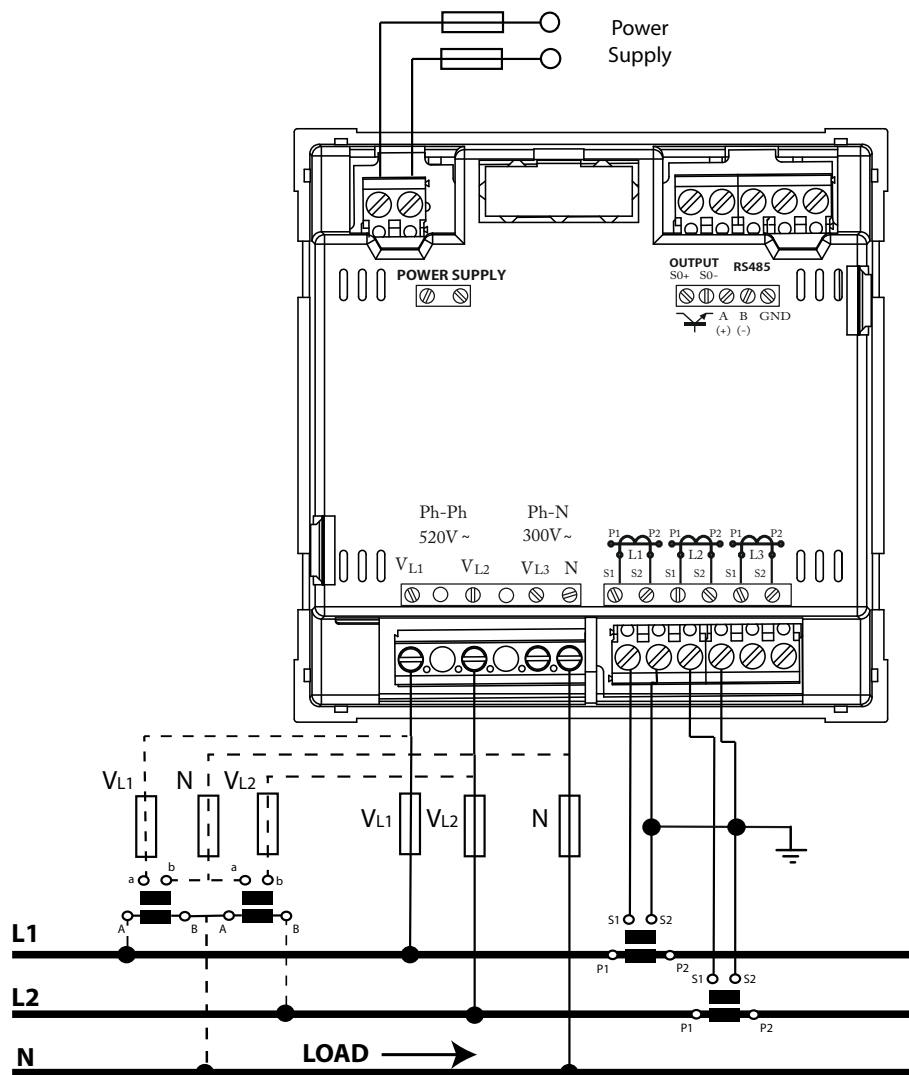

Figure 8: Two-phase measuring with a 3-wire connection.

3.4.7.- PHASE-TO-PHASE SINGLE-PHASE NETWORK MEASURING WITH A 2-WIRE CONNECTION.

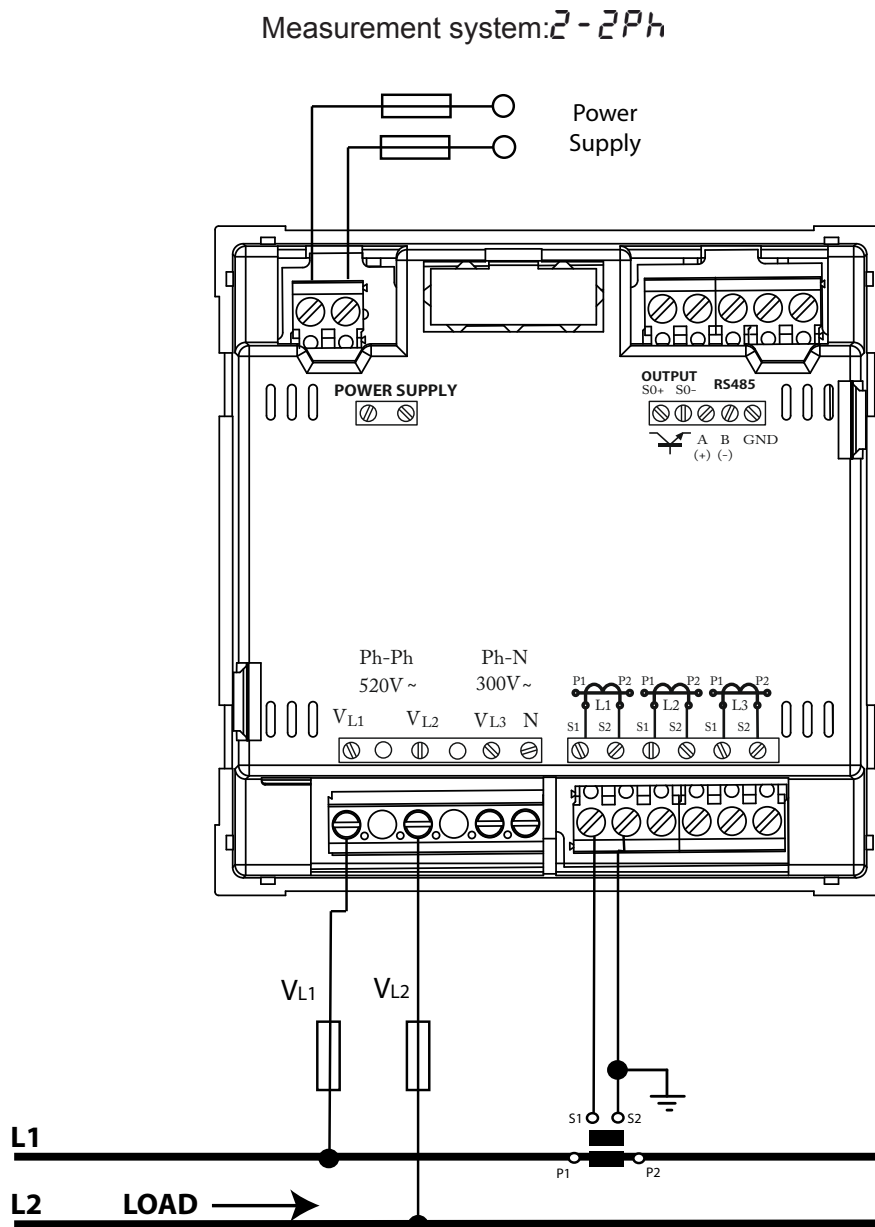

Figure 9: Phase-to-phase single-phase measuring with a 2-wire connection.

3.4.8.- PHASE-TO-NEUTRAL SINGLE-PHASE NETWORK MEASURING WITH A 2-WIRE CONNECTION

Measurement system: 2 - 1Ph

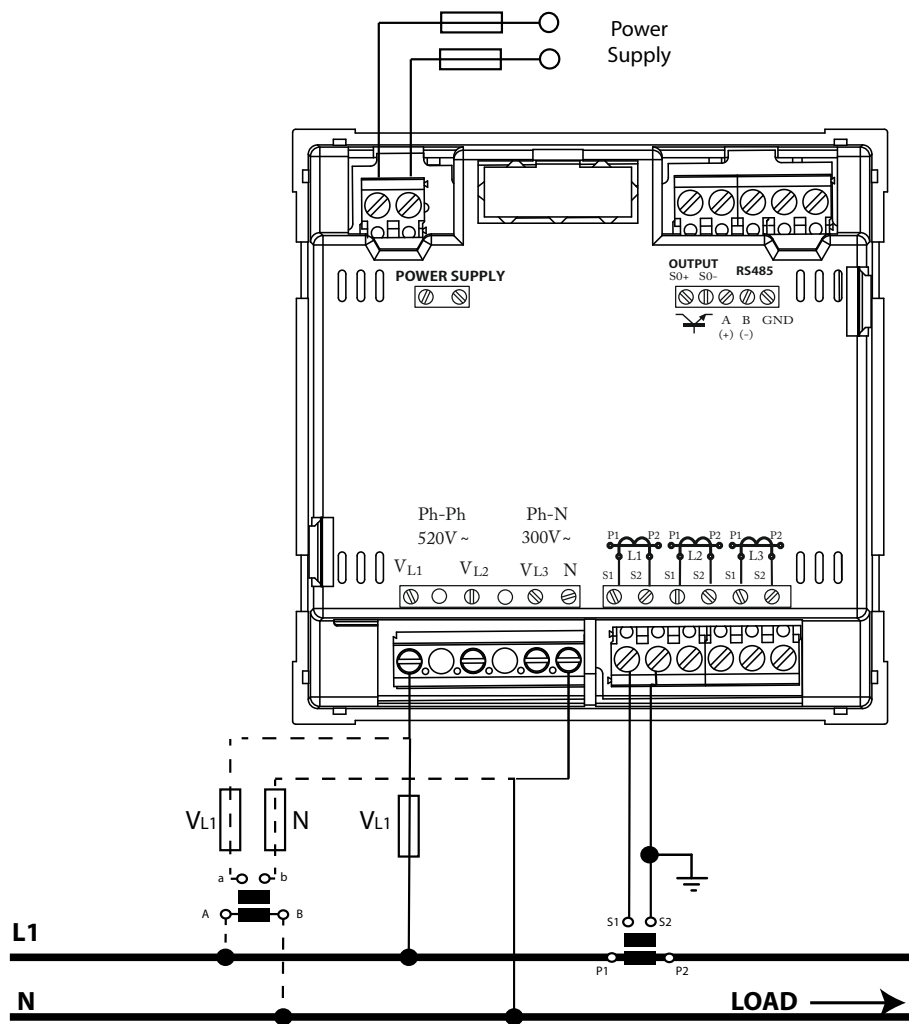

Figure 10: Phase-to-neutral single-phase measuring with a 2-wire connection.

4.- OPERATION

The **CVM-C5** is a power analyzer in four quadrants (consumption and generation).

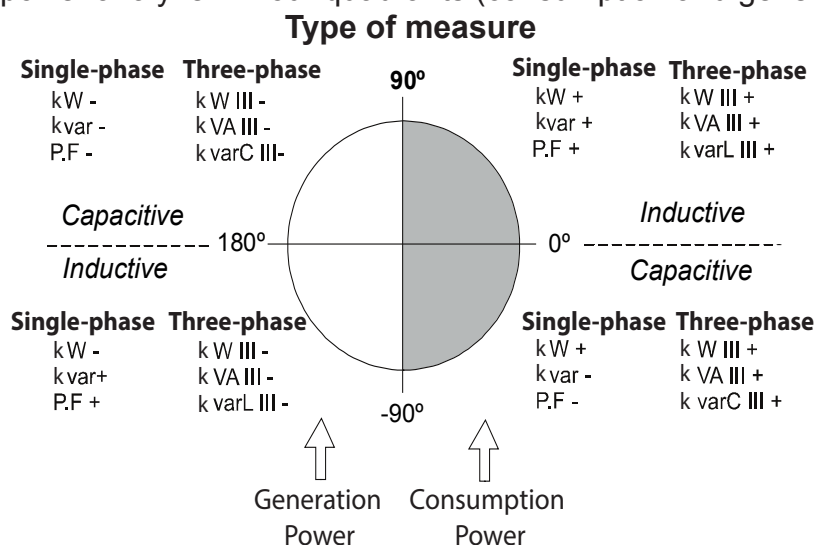

Figure 11: Four quadrants of CVM-C5.

4.1.- MEASURING PARAMETERS

The device displays the electrical parameters shown in **Table 4**.

Table 4: CVM-5 measuring parameters.

Parameter	Units	Maximum value	Minimum value
Phase – neutral voltage	Vph-n	999.9	10.0
Phase-phase voltage	Vph-ph	999.9	10.0
Current	A	9999	0.05
Frequency	Hz	65	45
Active Power	kW	9999	0.01
Inductive Reactive Power	kvarL	9999	0.01
Capacitive Reactive Power	kvarC	9999	0.01
Apparent Power	kVA	9999	0.01
Power factor	PF	-0.99	0.99
Cos φ	φ	-0.99	0.99
THD % voltage	% THD V	999.9	000.0
THD % current	% THD A	999.9	000.0
Total Active Energy Consumed Tariff 1	kWh	999999	000.000
Total Active Energy Generated Tariff 1	kWh	999999	000.000
Inductive Reactive Energy Consumed Tariff 1	kvar ^L h	999999	000.000
Inductive Reactive Energy Generated Tariff 1	kvar ^L h	999999	000.000
Capacitive Reactive Energy Consumed Tariff 1	kvar ^C h	999999	000.000
Capacitive Reactive Energy Generated Tariff 1	kvar ^C h	999999	000.000
Total Apparent Energy Tariff 1	kVAh	999999	000.000
Total Active Energy Consumed Tariff 2	kWh	999999	000.000
Total Active Energy Generated Tariff 2	kWh	999999	000.000

Table 4 (Continuation): CVM-5 measuring parameters.





Parameter	Units	Maximum value	Minimum value
Inductive Reactive Energy Consumed Tariff 2	kvar·h	999999	000.000
Inductive Reactive Energy Generated Tariff 2	kvar·h	999999	000.000
Capacitive Reactive Energy Consumed Tariff 2	kvar _c ·h	999999	000.000
Capacitive Reactive Energy Generated Tariff 2	kvar _c ·h	999999	000.000
Total Apparent Energy Tariff 2	kVAh	999999	000.000
No. of hours Tariff 1	hours	99999.9	00000.0
No. of hours Tariff 2	hours	99999.9	00000.0
Cost Tariff 1	COST	9999.99	0000.00
Cost Tariff 2	COST	9999.99	0000.00
CO ₂ Emissions Tariff 1	kgCO ₂	9999.99	0000.00
CO ₂ Emissions Tariff 2	kgCO ₂	9999.99	0000.00
Maximum Demand of Active power	kW	9999	0.01
Maximum Demand of Apparent Power	kVA	9999	0.01
Maximum Current Demand	A	9999	0.05

4.2.- KEYBOARD FUNCTIONS

The **CVM-C5** has 3 keys that allow you to browse between the various screens and program the device.



The first keystroke on any of the keys after a period of inactivity switches on the backlight. Key functions on measuring screens (**Table 5**):

Table 5: Key functions on measuring screens.

Key	Short keystroke	Long keystroke (2 s)
	Previous screen of the instant data area	Display of minimum value
	Next screen of the instant data area	Display of maximum value
	Browsing the different screens of the consumption data area	Accessing the programming menu
		Display of the Maximum Demand programmed and selected.

Key functions in the programming menu (**Table 6**):

Table 6: Key functions in the programming menu.

Key	Keystroke
	Moves an editable digit (flashing)
	Increases the digits (0-9) or rotates between the different options.
	Next page

4.3.- DISPLAY

The device has a backlit LCD display showing all the parameters listed in **Table 4**.

The display is divided into two areas (**Figure 12**):

- ✓ The **consumption data** area showing consumption parameters.
- ✓ The **instantaneous data** area showing the maximum and minimum instantaneous values being measured or calculated by the device.

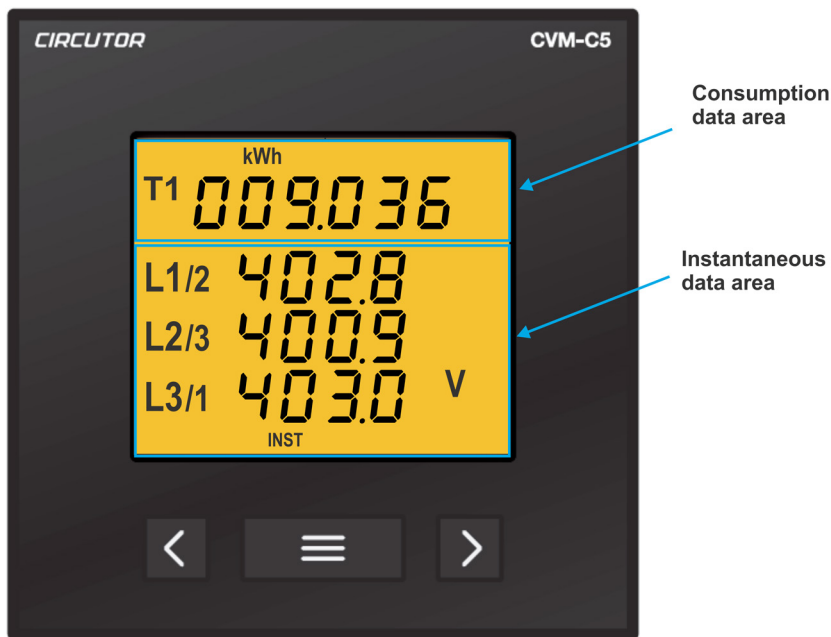

Figure 12: CVM-C5 display areas.

4.3.1. CONSUMPTION DATA AREA

The device has 22 different screens in the consumption data area (**Table 7**).

Table 7: Consumption data area screens.









Screen	Units
Total active energy generated Tariff 1 	kWh
Inductive reactive energy generated Tariff 1 	kvar ^l ·h
Capacitive reactive energy generated Tariff 1 	kvar _c ·h

Table 7 (Continuation): Consumption data area screens.

Screen	Units
Total apparent energy generated Tariff 1 kVAh T1 - 000000	kVAh
CO ₂ Emissions Tariff 1 kgCO_2 T1 000000	kgCO ₂
Cost Tariff 1 COST T1 000000	COST
No. of hours Tariff 1 hours T1 000000	hours
Total active energy consumed Tariff 1 kWh T1 000000	kWh
Inductive reactive energy consumed Tariff 1 $\text{kvar}^{\text{L}}\text{h}$ T1 000000	kvar ^L h
Capacitive reactive energy consumed Tariff 1 kvar_ch T1 000000	kvar _c h
Total apparent energy consumed Tariff 1 kVAh T1 000000	kVAh
Total active energy generated Tariff 2 kWh T2 - 000000	kWh
Inductive reactive energy generated Tariff 2 $\text{kvar}^{\text{L}}\text{h}$ T2 - 000000	kvar ^L h
Capacitive reactive energy generated Tariff 2 kvar_ch T2 - 000000	kvar _c h
Total apparent energy generated Tariff 2 kVAh T2 - 000000	kVAh

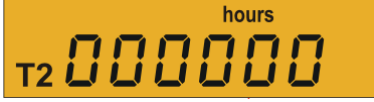
Table 7 (Continuation): Consumption data area screens.

Screen	Units
CO ₂ Emissions Tariff 2 	kgCO ₂
Cost Tariff 2 	COST
No. of hours Tariff 2 	hours
Total active energy consumed Tariff 2 	kWh
Inductive reactive energy consumed Tariff 2 	kvar ^l ·h
Capacitive reactive energy consumed Tariff 2 	kvar _c ·h
Total apparent energy consumed Tariff 2 	kVAh

With the  key we can browse between the different screens.

The symbols **T1** and **T2** that appear on the display indicate the selected tariff and the tariff being displayed, according to **Table 10**.

4.3.2. INSTANTANEOUS DATA AREA

To browse through the different screens that appear in the instantaneous data area, you have to use the **◀** and **▶** keys.

This data area has 13 different screens, **Table 8**.

Table 8: CVM-C5 instantaneous data screens







Measurement system	Screen	Units
4-3Ph 3-3Ph 3-ARON 3-2Ph 2-2Ph 2-1Ph	Voltage Phase L1- Phase L2 Voltage Phase L2- Phase L3 Voltage Phase L3- Phase L1	
4-3Ph 3-3Ph 3-ARON 3-2Ph 2-2Ph 2-1Ph	Voltage Phase - Neutral L1 Voltage Phase - Neutral L2 Voltage Phase - Neutral L3	
4-3Ph 3-3Ph 3-ARON 3-2Ph 2-2Ph 2-1Ph	Current L1 Current L2 Current L3	
4-3Ph 3-3Ph 3-ARON 3-2Ph 2-2Ph 2-1Ph	Active power L1 Active power L2 Active power L3	
4-3Ph 3-3Ph 3-ARON 3-2Ph 2-2Ph 2-1Ph	Apparent power L1 Apparent power L2 Apparent power L3	
4-3Ph 3-3Ph 3-ARON 3-2Ph 2-2Ph 2-1Ph	Inductive Reactive Power L1 Inductive Reactive Power L2 Inductive Reactive Power L3	

Table 8 (Continuation): CVM-C5 instantaneous data screens

Measurement system	Screen	Units	
4-3Ph 3-3Ph 3-ARON 3-2Ph 2-2Ph 2-1Ph	Capacitive Reactive Power L1 Capacitive Reactive Power L2 Capacitive Reactive Power L3		kvarC
4-3Ph 3-3Ph 3-ARON 3-2Ph 2-2Ph 2-1Ph	Power factor L1 Power factor L2 Power factor L3		PF
4-3Ph 3-3Ph 3-ARON 3-2Ph 2-2Ph 2-1Ph	Active three-phase power Inductive Reactive three-phase Power Apparent three-phase power		kW kvarL kVA
4-3Ph 3-3Ph 3-ARON 3-2Ph 2-2Ph 2-1Ph	Active three-phase power Capacitive Reactive three-phase Power Apparent three-phase power		kW kvarC kVA
4-3Ph 3-3Ph 3-ARON 3-2Ph 2-2Ph 2-1Ph	Frequency Cos φ		Hz φ
4-3Ph 3-3Ph 3-ARON 3-2Ph 2-2Ph 2-1Ph	THD Voltage L1 THD Voltage L2 THD Voltage L3		V
4-3Ph 3-3Ph 3-ARON 3-2Ph 2-2Ph 2-1Ph	THD Current L1 THD Current L2 THD Current L3		A

Also displayed on these screens are:

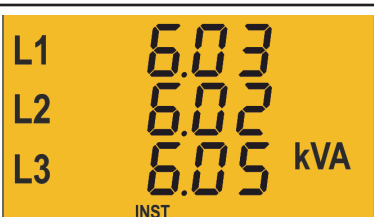
✓ **Maximum values**

To see the maximum values of the screen being displayed, press the **>** key for 2 seconds.

The **MAX** symbol appears on the display (Figure 13)



Figure 13: Instantaneous data screen displaying maximum values.

✓ **Minimum values**

To see the minimum values of the screen being displayed, press the **<** key for 2 seconds.

The **MIN** symbol appears on the display (Figure 14)



Figure 14: Instantaneous data screen displaying minimum values.

✓ **Maximum Demand**

The device can calculate the maximum demand of:

- Active three-phase power,
- Apparent three-phase Power
- Current L1, L2 and L3.

Once the parameter to be integrated into the programming menu has been selected (“4.6.10. **Maximum demand variable**”), you can display it on the display screen for the parameter by pressing the **<** and **>** keys simultaneously.

The **DEM** symbol appears on the display and flashes the calculated value of maximum demand (Figure 15)

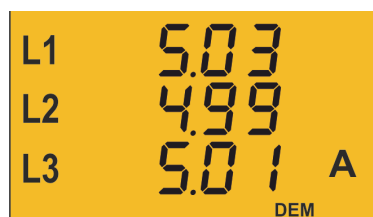

Figure 15: Instantaneous data screen displaying the maximum demand value.

4.4.- TARIFFS

The **CVM-C5** has two tariffs, T1 and T2, which can be selected through a Modbus. See “**4.7.2.1. Selecting the active tariff**”.

In the model **CVM-C5-xxx-485-I** can also be selected tariff via the digital input. Depending on the state of the input, see **Table 9**.

Table 9: Tariff selection.

Tariff	Digital input
T1	0
T2	1

The symbols **T1** and **T2** that appear on the display in the consumption data area indicate the selected tariff and the tariff being shown according to **Table 10**.

Table 10: Displaying tariffs on the display.

Symbol	Display	Selected tariff
T1 flashing	Tariff 1	Tariff 1
T1 flashing T2 steady	Tariff 2	Tariff 1
T1 flashing	Tariff 2	Tariff 2
T2 flashing T1 steady	Tariff 1	Tariff 2

4.5.- DIGITAL OUTPUT (Model **CVM-C5-xxx-RS485-C**)

The model **CVM-C5-xxx-RS485-C** has an optoisolated NPN transistor (terminals 3 and 4 of **Figure 1**) that may be programmed as:

- ✓A pulse output by kWh or kvarh.
- ✓An **alarm** associated with a measurement parameter.



4.6.- PROGRAMMING

From the programming menu you can:

- ✓ Define the transformation ratios.
- ✓ Program the ratio of kgCO₂ carbon emissions of the two tariffs.
- ✓ Program the cost ratio of the two tariffs.
- ✓ Program the maximum demand parameters.
- ✓ Delete the energy meters and the maximum and minimum values.
- ✓ Modify the display's backlight.
- ✓ Program the digital output.
- ✓ Program the Modbus communications.

The **CVM-C5** does not record programming changes until the programming is complete. If the device is RESET before finishing the programming or no key is pressed for 30 seconds, the configuration will not be stored in the memory.

The **CVM-C5** does not take any measurements during programming.

To enter the programming menu press the  key for 3 seconds.
And press  to access the first programming point.

4.6.1. PRIMARY VOLTAGE



On this screen the voltage transformer primary is programmed.

To enter or modify the transformer primary value, press the  key repeatedly, increasing the value of the flashing digit.

When the on-screen value is that desired, press the  key to go to the next digit to modify the other values.

If you press the  key after changing the last digit, it will jump back to the first digit so you can modify the previously programmed values again.

To validate the information and go to the next programming step, press .

If the value entered is greater than the maximum programming value, the digits flash for 2 seconds and the programmed value is deleted.

Maximum programming value: 01000.

Minimum programming value: 0.

4.6.2. SECONDARY VOLTAGE

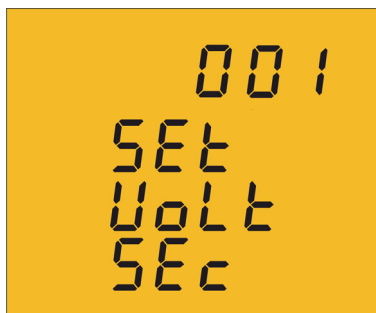

On this screen the voltage transformer secondary is programmed.

To enter or modify the voltage transformer secondary value, press the  key repeatedly, increasing the value of the flashing digit.

When the on-screen value is that desired, press the  key to go to the next digit and modify the other values.

If you press the  key after changing the last digit, it will jump back to the first digit so you can modify the previously programmed values again.

To validate the information and go to the next programming step, press .

If the value entered is greater than the maximum programming value, the digits flash for 2 seconds and the programmed value is deleted.

Maximum programming value: 999.

Minimum programming value: 0.

4.6.3. PRIMARY CURRENT



On this screen the current transformer primary is programmed.

To enter or modify the transformer primary value, press the  key repeatedly, increasing the value of the flashing digit.

When the on-screen value is that desired, press the  key to go to the next digit to modify the other values.

If you press the  key after changing the last digit, it will jump back to the first digit so you can modify the previously programmed values again.

To validate the information and go to the next programming step, press .

If the value entered is greater than the maximum programming value, the digits flash for 2 seconds and the programmed value is deleted.

Maximum programming value: 9999.

Minimum programming value: 0.

4.6.4. SECONDARY CURRENT (ONLY THE MODEL CVM-C5-ITF-485)

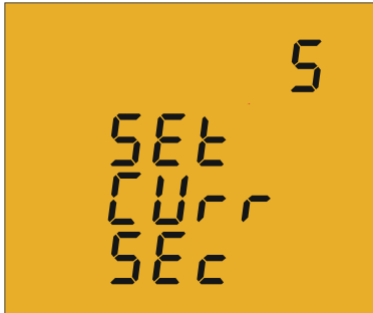

On this screen the current transformer secondary is selected.

Use the  key to jump between the two possible options for the current transformer secondary (1 A or 5 A).

To validate the information and go to the next programming step, press .

Note: If the voltage ratio together with the programmed current ratio exceeds the maximum power value that can be measured by the device, it will return to the primary voltage programming step when you press the  key.

Nota : To apply the change to the second current transformer is necessary to reset the computer.

4.6.5. MEASUREMENT SYSTEM



On this screen the measurement system to be used in the installation is selected.

The  key jumps between the different options

4-3PH Three-phase network measuring with a 4-wire connection.

3-3PH Three-phase network measuring with a 3-wire connection.

3-ARON Three-phase network measuring with a 3-wire connection and transformers in an ARON connection

3-2PH Two-phase network measuring with a 3-wire connection.

2-2PH Phase-to-phase single-phase network measuring with a 2-wire connection.

2-1PH Phase-to-neutral single-phase network measuring with a 2-wire connection.

To validate the information and go to the next programming step, press .

4.6.6. RATIO OF kgCO_2 CARBON EMISSIONS FOR TARIFF 1

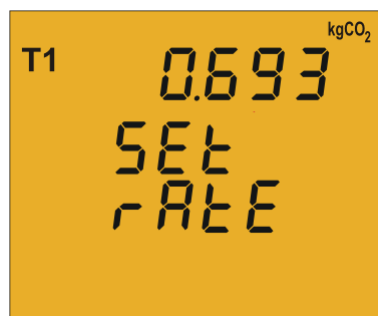

The carbon emissions ratio is the amount of emissions released into the atmosphere to produce a unit of electricity (1 kWh). The ratio for the European mix is approximately 0.65 kgCO_2 per kWh.

To enter or modify the emissions ratio value, press the  key repeatedly, increasing the value of the flashing digit.

When the on-screen value is that desired, press the  key to go to the next digit to modify the other values.

If you press the  key after changing the last digit, it will jump back to the first digit so you can modify the previously programmed values again.

To validate the information and go to the next programming step, press .

If the value entered is greater than the maximum programming value, the digits flash for 2 seconds and the programmed value is deleted.

Maximum programming value: 9.999.

Minimum programming value: 0.

4.6.7. COST RATIO FOR TARIFF 1

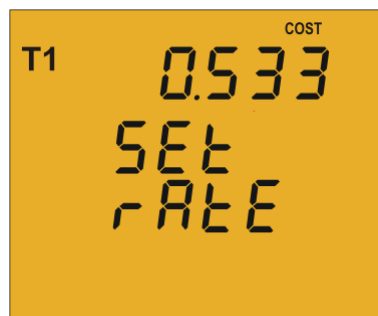

On this screen the cost per kWh of electricity of Tariff 1 is programmed.

To enter or modify the cost ratio value, press the  key repeatedly, increasing the value of the flashing digit.

When the on-screen value is that desired, press the  key to go to the next digit to modify the other values.

If you press the  key after changing the last digit, it will jump back to the first digit so you can modify the previously programmed values again.

To validate the information and go to the next programming step, press .

If the value entered is greater than the maximum programming value, the digits flash for 2 seconds and the programmed value is deleted.

Maximum programming value: 9.999.

Minimum programming value: 0.

4.6.8. RATIO OF kgCO_2 CARBON EMISSIONS FOR TARIFF 2



The carbon emissions ratio is the amount of emissions released into the atmosphere to produce a unit of electricity (1kWh). The ratio for the European mix is approximately 0.65 kgCO_2 per kWh.

To enter or modify the emissions ratio value, press the  key repeatedly, increasing the value of the flashing digit.

When the on-screen value is that desired, press the key to go to the next digit  to modify the other values.

If you press the  key after changing the last digit, it will jump back to the first digit so you can modify the previously programmed values again.

To validate the information and go to the next programming step, press .

If the value entered is greater than the maximum programming value, the digits flash for 2 seconds and the programmed value is deleted.

Maximum programming value: 9.999.

Minimum programming value: 0.

4.6.9. COST RATIO FOR TARIFF 2

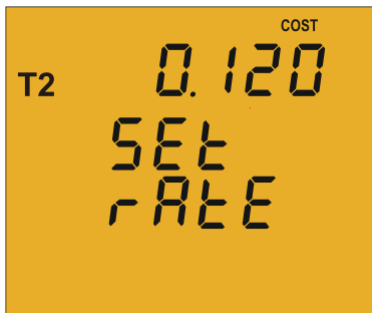

On this screen the cost per kWh of electricity of Tariff 2 is programmed.

To enter or modify the primary cost ratio value, press the  key repeatedly, increasing the value of the flashing digit.

When the on-screen value is that desired, press the  key to go to the next digit to modify the other values.

If you press the  key after changing the last digit, it will jump back to the first digit so you can modify the previously programmed values again.

To validate the information and go to the next programming step, press .

If the value entered is greater than the maximum programming value, the digits flash for 2 seconds and the programmed value is deleted.

Maximum programming value: 9.999.

Minimum programming value: 0.

4.6.10. MAXIMUM DEMAND VARIABLE



On this screen the variables to integrate into the Maximum Demand concept are selected.

The display shows the digits that identify that code for the variable to be integrated according to **Table 11**

Table 11: Codes for maximum demand variables

Parameter	Code
Active three-phase power	16
Apparent three-phase power	34
Three-phase current	36
Current L1, L2, L3	A - ph
None	00

The  key jumps between the different options.

To validate the information and go to the next programming step, press .

4.6.11. PERIOD OF MAXIMUM DEMAND INTEGRATION



On this screen the maximum demand integration period is programmed.

To enter or modify the integration period value, press the  key repeatedly, increasing the value of the flashing digit.

When the on-screen value is that desired, press the  key to go to the next digit to modify the other values.

If you press the  key after changing the last digit, it will jump back to the first digit so you can modify the previously programmed values again.

The integration period may range from 1 to 60 minutes.

To validate the information and go to the next programming step, press .

If the value entered is greater than the maximum programming value, the digits flash for 2 seconds and the programmed value is deleted.

4.6.12. DELETING MAXIMUM DEMAND



On this screen you select whether or not to delete the maximum demand.

Use the  key to jump between the two options (Yes and No).

To validate the information and go to the next programming step, press .

4.6.13. DEFAULT SCREEN



On this screen the default or start-up instantaneous data screen (Table 8) for the **CVM-C5** is selected.

Press the  key repeatedly until you see the default screen of your choice.

To validate the screen and go to the next programming step, press .

The electrical parameters may also be displayed by automatically rotating through the 7 instantaneous data screens in 5-second intervals.

To do so press the  key repeatedly until the parameters flash;

To validate the rotating screen function and go to the next programming step, press .

4.6.14. DISPLAY BACKLIGHT



On this screen the time that the Backlight will stay lit (in seconds) after the last keystroke on the unit is programmed.

To enter or modify the backlight value, press the  key repeatedly, increasing the value of the flashing digit.

When the on-screen value is that desired, press the  key to go to the next digit to modify the other values.

The value 00 indicates that the backlight will stay permanently lit. The backlight time may range from 5 to 99 seconds.

To validate the information and go to the next programming step, press .

4.6.15. PROGRAMMING THE DIGITAL OUTPUT (MODEL CVM-C-xxx-RS485-C)

The **CVM-C5** digital output may be programmed as:

- ✓ **Pulse by n kWh or kvarh (Energy):** the value corresponding to the energy consumed or generated may be programmed, to generate a pulse.
- ✓ **Alarm condition:** a magnitude may be associated with the digital output, setting a maximum, minimum and delay value for the trip condition.

If you do not wish to program a variable, put 00 and validate with the  key.

✓ Pulse programming by n kWh or kvarh



On this screen the energy code is selected based on **Table 12** for the energy you want the pulse output to generate.



The  key jumps between the different options.

Table 12: Codes for the different energy types.

Parameter	Code
Active Energy III Tariff 1	31
Inductive Reactive Energy III Tariff 1	32
Capacitive Reactive Energy III Tariff 1	33
Apparent Energy III Tariff 1	48
Active Energy III Generated Tariff 1	49
Inductive Reactive Energy III Generated Tariff 1	50
Capacitive Reactive Energy III Generated Tariff 1	51
Apparent Energy III Generated Tariff 1	52
Active Energy III Tariff 2	55
Inductive Reactive Energy III Tariff 2	56
Capacitive Reactive Energy III Tariff 2	57
Apparent Energy III Tariff 2	58
Active Energy III Generated Tariff 2	59
Inductive Reactive Energy III Generated Tariff 2	60
Capacitive Reactive Energy III Generated Tariff 2	61
Apparent Energy III Generated Tariff 2	62
Active Energy Consumed (Regardless of the tariff selected)	99

Once an Energy code has been selected and validated using the  key you must enter the kilowatts per pulse.



To enter or modify the kilowatts per pulse value, press the  key repeatedly, increasing the value of the flashing digit. When the on-screen value is that desired, press the  key to go to the next digit to modify the other values.

If you press the  key after changing the last digit, it will jump back to the first digit so you can modify the previously programmed values again.

Example: To program 500 Wh per pulse: 000.500
 To program 1.5 kWh per pulse: 001.500

Once the desired option has been programmed, press the  key to validate the information and thereby finish programming the device.

Maximum programming value: 999999 KWh.
Minimum programming value: 000.001 KWh.

✓ **Programming by alarm condition**

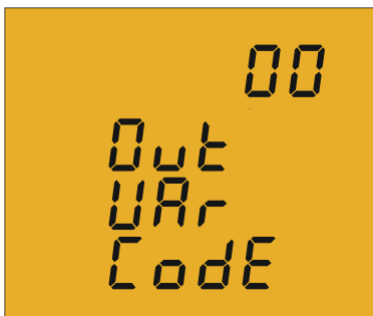

On this screen the parameter code for which you want an alarm to be generated is selected, based on **Table 13**.

The  key jumps between the different options.

Table 13: Parameter codes for alarm programming.

Parameter	Code	Parameter	Code
Voltage Phase - Neutral L1	01	THD voltage L3	27
Current L1	02	THD current L3	30
Active power L1	03	Active three-phase power	16
Inductive / Capative reactive power L1	04	Inductive Reactive three-phase power	17
Power factor L1	05	Capacitive Reactive three-phase power	18
THD voltage L1	25	Apparent three-phase power	34
THD current L1	28	Maximum demand	35
Voltage Phase - Neutral L2	06	Three-phase current	36
Current L2	07	Cos ϕ	19
Active power L2	08	Three-phase Power factor	20
Inductive / Capative reactive power L2	09	Frequency	21
Power factor L2	10	Voltage L1 - L2	22
THD voltage L2	26	Voltage L2 - L3	23
THD current L2	29	Voltage L3 - L1	24
Voltage Phase - Neutral L3	11	Maximum demand L1 ⁽¹⁾	35
Current L3	12	Maximum demand L2 ⁽¹⁾	42

Table 13 (Continuation): Parameter codes for alarm programming.

Parameter	Code	Parameter	Code
Active power L3	13	Power factor L3	15
Inductive / Capative reactive power L3	14	Maximum demand L3 ⁽¹⁾	43

⁽¹⁾ Parameter valid only if programmed the maximum demand current per phase.



In addition, there are some parameters (Table 14) that refer to the three phases at the same time (OR function). If you have selected one of these variables, the alarm will be activated when any of the three phases meets the programmed conditions.

Table 14: Multiple parameter codes for alarm programming.

Parameter	Code
Voltages Phase - Neutral	85
Currents	86
Active powers	87
Reactive powers	88
Power factor	89
Voltages Phase-Phase	90
THD V	91
THD A	92

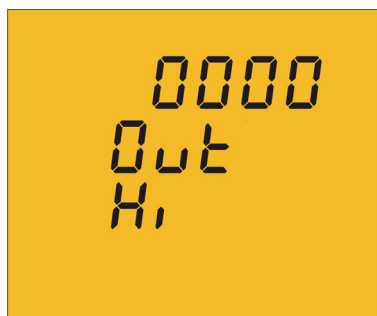
Once an alarm code has been selected and validated with the  key you must enter the maximum value of the alarm condition.





The **maximum value**: above this value the transistor is closed. To enter or modify the maximum value, press the  key repeatedly, increasing the value of the flashing digit. When the on-screen value is that desired, press the  key to go to the next digit to modify the other values.

If you press the  key after modifying the last digit the decimal point position will be programmed.

To validate the information and proceed to programming the minimum value, press  .



The **minimum value**: below this value the transistor is closed. To enter or modify the minimum value, press the  key repeatedly, increasing the value of the flashing digit. When the on-screen value is that desired, press the  key to go to the next digit to modify the other values.

If you press the  key after modifying the last digit the decimal point position will be programmed.

To validate the information and proceed to programming the delay value, press  .



This is where the device's connection and disconnection delay (in seconds) are programmed.

To enter or modify the delay value, press the  key repeatedly, increasing the value of the flashing digit.

When the on-screen value is that desired, press the  key to go to the next digit to modify the other values.

Once the delay has been programmed, press the  key to go to the next programming step. In **Table 15** we can see the functioning of the digital output based on the programmed maximum and minimum values.

Table 15: Functioning of the digital output based on the programmed maximum and minimum values.

Minimum value	Maximum value.	Condition	Digital output functioning
Positive	Positive	MAX > MIN	
Positive	Positive	MAX < MIN	
Negative	Positive		
Positive	Negative		
Negative	Negative	MAX > MIN	
Negative	Negative	MAX < MIN	

4.6.16. DELETING ENERGY METERS



On this screen you select whether or not to delete the energy meters.

Use the  key to jump between the two options (Yes and No).

To validate the information and go to the next programming step, press .

4.6.17. DELETING MAXIMUM AND MINIMUM VALUES

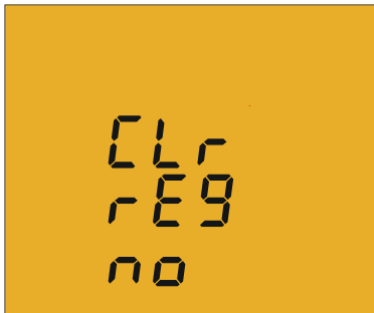

On this screen you select whether or not to delete the maximum and minimum values

Use the  key to jump between the two options (Yes and No).

To validate the information and go to the next programming step, press .

4.6.18. MODBUS COMMUNICATIONS : DEFAULT PARAMETERS

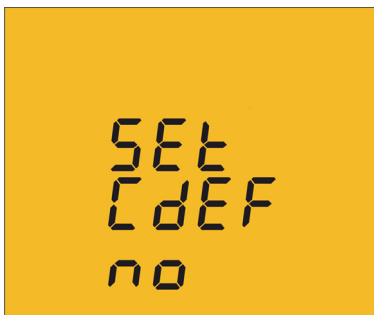

On this screen you select whether we want to return to the default parameters of the Modbus communications.

Default parameters:

Peripheral number : 1

Transmission speed : 9600

Parity : No

Number of data bits : 8

Number of Stop bits : 1

Use the  key to jump between the two options: Yes or No

If you select the **Yes** option, the device jumps to step programming **“4.6.24. Locking the programming”**

To validate the information and go to the next programming step, press .

4.6.19. MODBUS COMMUNICATIONS : PERIPHERAL NUMBER

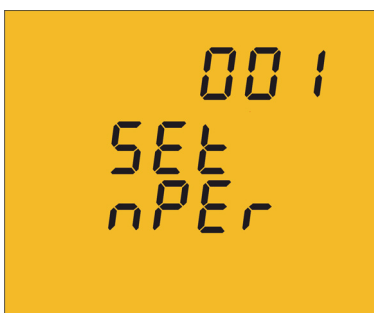

The peripheral number is programmed on this screen.

To enter or modify the delay value, press the  key repeatedly, increasing the value of the flashing digit.

When the on-screen value is that desired, press the **<** key to go to the next digit to modify the other values.

To validate the information and go to the next programming step, press **>**.

The peripheral number ranges from **0** to **255**.

4.6.20. MODBUS COMMUNICATIONS : TRANSMISSION SPEED



The transmission speed of modbus communications is programmed on this screen.

The different options are: **1200, 2400, 4800, 9600** o **19200**.

The **≡** key jumps between the different options.

To validate the information and go to the next programming step, press **>**.

4.6.21. MODBUS COMMUNICATIONS : PARITY



The type of parity of Modbus communications is selected on this screen.

The **≡** key jumps between the different options.

- no* , no parity
- EVEN*, even parity.
- odd*, odd parity.

To validate the information and go to the next programming step, press **>**.

4.6.22. MODBUS COMMUNICATIONS : NUMBER OF DATA BITS

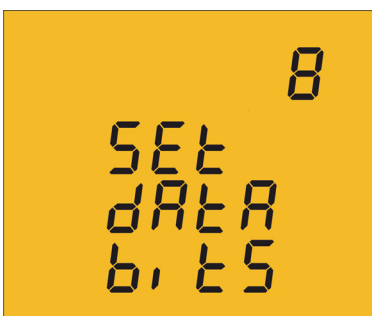

The number of data bits of Modbus communications are displayed on this screen: **8 bits**.

This parameter is not configurable.

To go to the next programming step, press **>**.

4.6.23. MODBUS COMMUNICATIONS : NUMBER OF STOP BITS



The number of Stop bits of Modbus communications are programmed on this screen.

Press key  to browse the options: 1 or 2 bits.

To validate the information and go to the next programming step, press .

4.6.24. LOCKING THE PROGRAMMING



This screen is for protecting the data configured in the programming menu.

Use the  key to jump between the two options:

unLo

When you enter the programming menu you can view and modify the programming.

LoC

When you enter the programming you can view the programming but not modify it. . In order to modify the programming you need to enter a password.

To validate the information and go to the next programming step, press .

4.6.25. PASSWORD

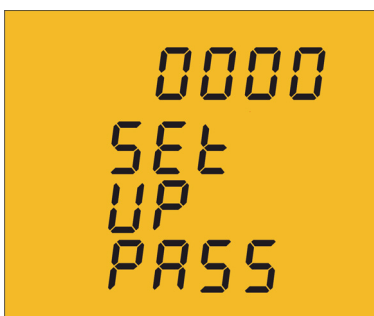

On this screen the password to modify the programming parameters is programmed.

To enter or modify the value, press the  key repeatedly, increasing the value of the flashing digit.

When the on-screen value is that desired, press the  key to go to the next digit to modify the other values.

Default value: 1234.

Press the  key to finish programming the device.

4.7.- COMMUNICATIONS

The **CVM-C5** have one RS-485 communications port, with **MODBUS RTU** ® protocol.

4.7.1. CONNECTIONS

The RS-485 cable must be wired with twisted pair cable with mesh shield (minimum 3 wires), with a maximum distance between the **CVM-C5** and the master unit of 1200 metres. A maximum of 32 **CVM-C5** units can be connected to this bus.

Use an intelligent RS-232 to RS-485 network protocol converter to establish the communications with the master unit.

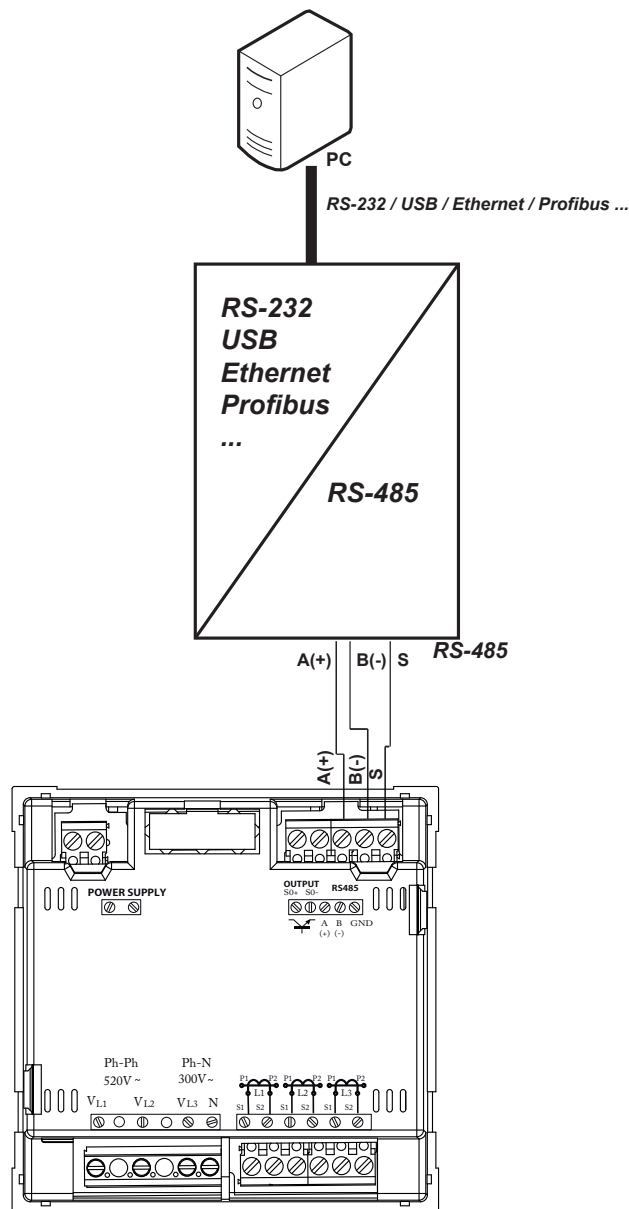

Figure 16: RS-485 Connection diagram.

4.7.2. PROTOCOL

In the Modbus protocol, the **CVM-C5** unit uses the RTU (Remote Terminal Unit) mode.

The Modbus functions implemented in the unit are as follows:

Function 03 and 04. Reading n Words (2 bytes). Function used for reading the parameters being measured by the CVM-C5. All parameters are 32-bits long, which is why to ask each parameter takes two Words.

Function 10. Writing multiple logs.

4.7.2.1. Selecting the active tariff

The **CVM-C5** has two tariffs, T1 and T2, selectable using the following Modbus function:

✓ **Selecting the active tariff:**

Address	Function	Registro inicial	No registers	No bytes	Tariff	CRC
NP ⁽¹⁾	10	1388	0001	02	000T ⁽²⁾	xxxx

⁽¹⁾ NP : Peripheral number

⁽²⁾ The selection of the active tariff is selected according to the following table:

Table 16:Selecting tariff.

Code	Tariff
0	Tariff T1
1	Tariff T2

Response:

Address	Function	Initial register	No registers	CRC
NP ⁽¹⁾	10	1388	0001	xxxx

✓ **reading active tariff.**

Address	Function	Initial register	No registers	CRC
NP ⁽¹⁾	04	1388	0001	xxxx

Response:

Address	Function	No bytes	No registers	CRC
NP ⁽¹⁾	04	02	000T ⁽²⁾	xxxx

4.7.2.2. Measurement variables.

All the addresses of Modbus memory are in Hexadecimal.

For these variables is implemented the **Function 0x03** and **0x04**.

Table 17: Modbus memory map (Table 1)

Parameter	Symbol	Instantaneous	Maximum	Minimum	Units
L1 Phase-Neutral voltage	V 1	00-01	84-85	100-101	V x 10
L1 Current	A 1	02-03	86-87	102-103	mA
L1 Active Power	kW 1	04-05	88-89	104-105	W
L1 Reactive Power	kvar 1	06-07	8A-8B	106-107	var
L1 Inductive Reactive Power	kvarL1	17C-17D	18E-18F	1A0-1A1	var
L1 Capacitive Reactive Power	kvarC1	182-183	194-195	1A6-1A7	var
L1 Apparent Power	kVAL1	188-189	19A-19B	1AC-1AD	VA
L1 Power Factor	PF 1	08-09	8C-8D	108-109	x100
L2 Phase-Neutral voltage	V 2	0A-0B	8E-8F	10A-10B	V x 10
L2 Current	A 2	0C-0D	90-91	10C-10D	mA
L2 Active Power	kW 2	0E-0F	92-93	10E-10F	W
L2 Reactive Power	kvar 2	10-11	94-95	110-111	var
L2 Inductive Reactive Power	kvarL2	17E-17F	190-191	1A2-1A3	var
L2 Capacitive Reactive Power	kvarC2	184-185	196-197	1A8-1A9	var
L2 Apparent Power	kVAL2	18A-18B	19C-19D	1AE-1AF	VA
L2 Power Factor	PF 1	12-13	96-97	112-113	x100
L3 Phase-Neutral voltage	V 3	14-15	98-99	114-115	V x 10
L3 Current	A 3	16-17	9A-9B	116-117	mA
L3 Active Power	kW 3	18-19	9C-9D	118-119	W
L3 Reactive Power	kvar 3	1A-1B	9E-9F	11A-11B	var
L3 Inductive Reactive Power	kvarL3	180-181	192-193	1A4-1A5	var
L3 Capacitive Reactive Power	kvarC3	186-187	198-199	1AA-1AB	var
L3 Apparent Power	kVAL3	18C-18D	19E-19F	1B0-1B1	VA
L3 Power Factor	PF 3	1C-1D	A0-A1	11C-11D	x100
Three-phase Active power	kW III	1E-1F	A2-A3	11E-11F	W
Three-phase Inductive Power	kvarL III	20-21	A4-A5	120-121	var
Three-phase Capacitive Power	kvarL III	22-23	A6-A7	122-123	var
Three-phase Cos ϕ	Cos ϕ III	24-25	A8-A9	124-125	x100
Three-phase Power Factor	PF III	26-27	AA-AB	126-127	x100
Frequency	Hz	28-29	AC-AD	128-129	Hz x 10
L1 - L2 Voltage	V12	2A-2B	AE-AF	12A-12B	V x 10
L2 - L3 Voltage	V23	2C-2D	B0-B1	12C-12D	V x 10
L3 - L1 Voltage	V31	2E-2F	B2-B3	12E-12F	V x 10
THD Voltage L1	%THDV1	30-31	B4-B5	130-131	% x 10
THD Voltage L2	%THDV2	32-33	B6-B7	132-133	% x 10
THD Voltage L3	%THDV3	34-35	B8-B9	134-135	% x 10
THD Current L1	%THDI1	36-37	BA-BB	136-137	% x 10
THD Current L2	%THDI2	38-39	BC-BD	138-139	% x 10
THD Current L3	%THDI3	3A-3B	BE-BF	13A-13B	% x 10
Three-phase Apparent Power	kvalIII	42-43	C6-C7	142-143	VA
Maximum demand	Md(Pd)	44-45	C8-C9	-	W/VA/mA

Parameter	Symbol	Instantaneous	Maximum	Minimum	Units
Three-phase current (average)	I_AVG	46-47	CA-CB	146-147	mA
Maximum demand I2	Md (Pd)	52-53	D6-D7	-	mA
Maximum demand I3	Md (Pd)	54-55	D8-D9	-	mA
Phase-Phase voltage (average)	VF-AVG	56-57	DA-DB	156-157	V x 10
Phase-Neutral voltage (average)	VL-AVG	58-59	DC-DD	158-159	V x 10

4.7.2.3. Energy variables

All the addresses of Modbus memory are in Hexadecimal.

For these variables is implemented the **Function 0x03** and **0x04**.

Table 18: Modbus memory map (Table 2).

Parameter	Symbol	Tariff 1	Tariff 2	Units
Active energy	kWh III	3C-3D	6C-6D	Wh
inductive reactive energy (kvarhL)	kvarhL III	3E-3F	6E-6F	varh
capacitive reactive energy (kvarhC)	kvarhC III	40-41	70-71	varh
apparent energy (kVAh)	kVAh III	5E-5F	72-73	kVAh
Generated active energy	kWh III (-)	60-61	74-75	Wh
Generated inductive reactive energy	kvarhL III (-)	62-63	76-77	varh
Generated capacitive reactive energy	kvarhC III	64-65	78-79	varh
Generated apparent energy	kVAh III	66-67	7A-7B	VAh
CO ₂ emissions	KgCO ₂	68-69	7C-7D	KgCO ₂ x 100000
Generation Cost	\$	6A-6B	7E-7F	\$ x 100000
Hours per tariff	Hours	80-81	82-83	seg

4.7.3. EXEMPLE MODBUS QUESTION

Question: Value of the Phase L1 - Phase L2 voltage

Address	Function	Initial register	No register	CRC
0A	04	2A	0002	xxxx

Address: 0A, Peripheral number: 10 in decimals.

Function: 04, Read function.

Initial register: 2A, register on which the reading will start.

No. of registers: 0002, number of registers read.

CRC: xxxx, CRC Character.

Response:

Address	Function	No Bytes	Register no 1	Register no 2	CRC
0A	04	04	0000	084D	xxxx

Address: 0A, Responding peripheral number: 10 in decimals.

Function: 04, Read function.

No. of bytes: 04, No. of bytes received.

Register: 0000084D, Value of the Phase L1 - Phase L2 voltage: $V_{12} \times 10 : 212.5 \text{ V}$

CRC: xxxx, CRC Character.

Note: Every Modbus frame has a maximum limit of 20 variables (40 register).

5.- TECHNICAL FEATURES

AC Power supply	
Rated voltage	95 ... 240 V~ ± 10%
Frequency	50 ... 60 Hz
Consumption	3.5... 6 VA
Installation category	CAT III 300V

DC Power supply	
Rated voltage	105 ... 272 V ^{DC} ± 10%
Consumption	2 ... 6W
Installation category	CAT III 300V

Voltage measurement circuit	
Nominal voltage (Un)	300V P-N, 520V P-P
Voltage measurement margin	5 ... 120% Un
Frequency measurement margin	45 ... 65Hz
Input impedance	440 kΩ
Min. voltage measurement (Vstart)	10V P-N
Installation category	CAT III 300V

Current measurement circuit				
Model	CVM-C5-ITF-485	CVM-C5-MC-485		CVM-C5-mV-485
Nominal current (In)	.../5A o .../1A	.../0.250 A		.../0.333 A
Current measurement margin	5 ...110% In	5 ...110% In		5 ...110% In
Maximum current, impulse < 1s	100 A	100 A		1.2 In
Minimum current measurement (Istart)	10 mA	MC1	MC3	6.66 mA
		0.25 A	0.12 A	
Installation Category	CAT III 300V	CAT III 300V		CAT III 300V

Measurement accuracy				
Model	CVM-C5-ITF-485	CVM-C5-MC-485		CVM-C5-mV-485
Voltage measurement	0.5%	0.5%		1%
Current measurement	0.5% ± 1 digit	0.5% ± 1 digit		1%
Power measurement	1% ± 1 digit	1% ± 1 digit		2%
Active energy measurement	Class 1	Class 1		Class 2
Reactive energy measurement	Class 1	Class 1		Class 2

Communications	
Bus	RS-485
Protocol	Modbus RTU
Baud rate	1200 - 2400 - 4800 - 9600 - 19200
Stop bits	1 - 2
Parity	without - even - odd

Pulse output (CVM-C5-xxx-RS485-C) ⁽¹⁾	
Type	NPN
Maximum voltage	24 V ^{DC}
Maximum current	50 mA
Maximum frequency	5 pulses / sec

(Continuation) Pulse output (CVM-C5-xxx-RS485-C) ⁽¹⁾

Minimum pulse width	100 ms (Ton: 100 ms, Toff: 100 ms)
----------------------------	------------------------------------

Digital input (CVM-C5-xxx-RS485-I) ⁽¹⁾

Type	Potential free contact
Insulation	Optoisolated

⁽¹⁾ Must be connected to SELV circuit.

User interface

Display	LCD (60x54mm)
Keyboard	3 keys

Environmental features

Operating temperature	-5°C... +45°C
Storage temperature	-10°C ... +50°C
Relative humidity (non-condensing)	5 ... 95%
Maximum altitude	2000 m
Protection degree ⁽²⁾	IP21 Front panel: IP51

⁽²⁾ This pollution degree hasn't been tested by UL.

Mechanical features

Dimensions (Figure 16)	96.7x96.7x62.6 mm
Weight	480 gr
Enclosure	V0 self-extinguishing plastic
Attachment	Panel

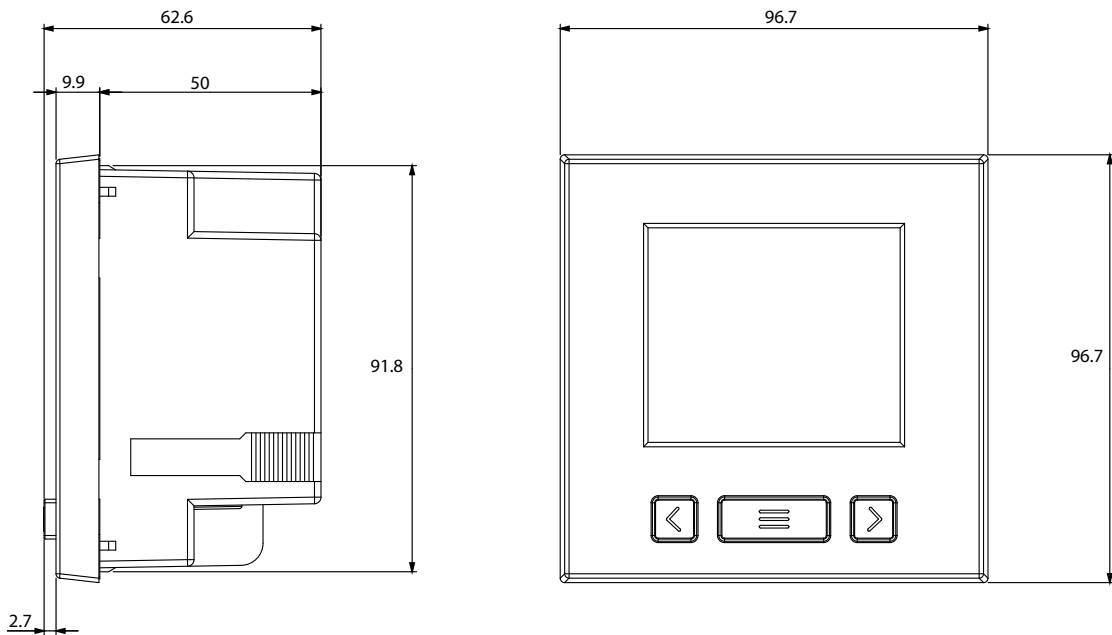

Figure 17:Dimensions.

Standards

Safety of electronic measuring units	IEC 61010: 2010
Electromagnetic compatibility (CEM). Part 6-4: Generic standards. Emissions standard for industrial environments.	UNE-EN 61000-6-4:2007
Electromagnetic compatibility (CEM). Part 6-2: Generic standards. Immunity for industrial environments.	UNE-EN 61000-6-2:2006
Safety requirements for electrical equipment for measurement, control, and laboratory use - Part 1: General requirements	UL/CSA 61010-1 3rd edition

6.- MAINTENANCE AND TECHNICAL SERVICE

In the case of any query in relation to unit operation or malfunction, please contact the **CIRCUTOR, SA** Technical Support Service.

Technical Assistance Service

Vial Sant Jordi, s/n, 08232 - Viladecavalls (Barcelona)

Tel: 902 449 459 (España) / +34 937 452 919 (outside of Spain)

email: sat@circutor.es

7.- GUARANTEE

CIRCUTOR guarantees its products against any manufacturing defect for two years after the delivery of the units.

CIRCUTOR will repair or replace any defective factory product returned during the guarantee period.



- No returns will be accepted and no unit will be repaired or replaced if it is not accompanied by a report indicating the defect detected or the reason for the return.
- The guarantee will be void if the units has been improperly used or the storage, installation and maintenance instructions listed in this manual have not been followed. "Improper usage" is defined as any operating or storage condition contrary to the national electrical code or that surpasses the limits indicated in the technical and environmental features of this manual.
- **CIRCUTOR** accepts no liability due to the possible damage to the unit or other parts of the installation, nor will it cover any possible sanctions derived from a possible failure, improper installation or "improper usage" of the unit. Consequently, this guarantee does not apply to failures occurring in the following cases:
 - Overvoltages and/or electrical disturbances in the supply;
 - Water, if the product does not have the appropriate IP classification;
 - Poor ventilation and/or excessive temperatures;
 - Improper installation and/or lack of maintenance;
 - Buyer repairs or modifications without the manufacturer's authorisation.

8.- CE CERTIFICATE



CIRCUTOR, SA – Vial Sant Jordi, s/n
08232 Viladecavalls (Barcelona) Spain
(+34) 937 452 900 – info@circutor.com



DECLARACIÓN UE DE CONFORMIDAD

La presente declaración de conformidad se expide bajo la exclusiva responsabilidad de CIRCUTOR con dirección en Vial Sant Jordi, s/n – 08232 Viladecavalls (Barcelona) España

Producto:

Analizadores de redes panel 96 x96

Serie:

CVM-C5

Marca:

CIRCUTOR

EL objeto de la declaración es conforme con la legislación de armonización pertinente en la UE, siempre que sea instalado, mantenido y usado en la aplicación para la que ha sido fabricado, de acuerdo con las normas de instalación aplicables y las instrucciones del fabricante

2014/35/UE: Low Voltage Directive 2014/30/UE: Electromagnetic Compatibility Directive
2011/65/UE: RoHS2 Directive

Está en conformidad con la(s) siguiente(s) norma(s) u otro(s) documento(s) normativos(s):

IEC 61010-1:2010+AMD1:2016 CSV Ed 3.0 IEC 61326-1:2012 Ed 2.0
IEC 61000-6-2:2016 Ed 3.0 IEC 61000-6-4:2006+AMD1:2010 CSV Ed 2.1
UL 61010-1, 3rd Edition, 2012-5

Año de marcado "CE":

2014



EU DECLARATION OF CONFORMITY

This declaration of conformity is issued under the sole responsibility of CIRCUTOR with registered address at Vial Sant Jordi, s/n – 08232 Viladecavalls (Barcelona) Spain

Product:

Power analyzer mounting panel 96 x96

Series:

CVM-C5

Brand:

CIRCUTOR

The object of the declaration is in conformity with the relevant EU harmonisation legislation, provided that it is installed, maintained and used for the application for which it was manufactured, in accordance with the applicable installation standards and the manufacturer's instructions

2014/35/UE: Low Voltage Directive 2014/30/UE: Electromagnetic Compatibility Directive
2011/65/UE: RoHS2 Directive

It is in conformity with the following standard(s) or other regulatory document(s):

IEC 61010-1:2010+AMD1:2016 CSV Ed 3.0 IEC 61326-1:2012 Ed 2.0
IEC 61000-6-2:2016 Ed 3.0 IEC 61000-6-4:2006+AMD1:2010 CSV Ed 2.1
UL 61010-1, 3rd Edition, 2012-5

Year of CE mark:

2014



DECLARATION UE DE CONFORMITÉ

La présente déclaration de conformité est délivrée sous la responsabilité exclusive de CIRCUTOR dont l'adresse postale est Vial Sant Jordi, s/n – 08232 Viladecavalls (Barcelona) Espagne

Produit:

analyseurs de réseaux triphasés panneau 96x96

Série:

CVM-C5

Marque:

CIRCUTOR

L'objet de la déclaration est conforme à la législation d'harmonisation pertinente dans l'UE, à condition d'avoir été installé, entretenu et utilisé dans l'application pour laquelle il a été fabriqué, conformément aux normes d'installation applicables et aux instructions du fabricant

2014/35/UE: Low Voltage Directive 2014/30/UE: Electromagnetic Compatibility Directive
2011/65/UE: RoHS2 Directive

Il est en conformité avec la(les) suivante(s) norme(s) ou autre(s) document(s) réglementaire(s):

IEC 61010-1:2010+AMD1:2016 CSV Ed 3.0 IEC 61326-1:2012 Ed 2.0
IEC 61000-6-2:2016 Ed 3.0 IEC 61000-6-4:2006+AMD1:2010 CSV Ed 2.1
UL 61010-1, 3rd Edition, 2012-5

Année de marquage « CE »:

2014



Viladecavalls (Spain), 17/10/2017
General Manager: Ferran Gil Torné

KONFORMITÄTSERKLÄRUNG UE

Vorliegende Konformitätserklärung wird unter alleiniger Verantwortung von CIRCUTOR mit der Anschrift, Vial Sant Jordi, s/n – 08232 Viladecavalls (Barcelona) Spanien, ausgestellt

Produkt:

Dreiphasen-Leistungsanalyser Schaltfrel 96 x96

Série:

CVM-C5

Marke:

CIRCUTOR

Der Gegenstand der Konformitätserklärung ist konform mit der geltenden Gesetzgebung zur Harmonisierung der EU, sofern die Installation, Wartung und Verwendung der Anwendung seinem Verwendungszweck entsprechend gemäß den geltenden Installationsstandards und der Vorgaben des Herstellers erfolgt.

2014/35/UE: Low Voltage Directive 2014/30/UE: Electromagnetic Compatibility Directive

2011/65/UE: RoHS2 Directive

Es besteht Konformität mit der/den folgender/folgenden Norm/Normen oder sonstigem/sonstiger Regelwerk/Regelwerken

IEC 61010-1:2010+AMD1:2016 CSV Ed.3.0 IEC 61326-1:2012 Ed. 2.0

IEC 61000-6-2:2016 Ed. 3.0 IEC 61000-6-4:2006+AMD1:2010 CSV Ed.2.1

UL 61010-1, 3rd Edition, 2012-5

Jahr der CE-Kennzeichnung:

2014

DECLARAÇÃO DA UE DE CONFORMIDADE

A presente declaração de conformidade é expedida sob a exclusiva responsabilidade da CIRCUTOR com morada em Vial Sant Jordi, s/n – 08232 Viladecavalls (Barcelona) Espanha

Produto:

Analisadores de redes painel 96 x96

Série:

CVM-C5

Marca:

CIRCUTOR

O objeto da declaração está conforme a legislação de harmonização pertinente na UE, sempre que seja instalado, mantido e utilizado na aplicação para a qual foi fabricado, de acordo com as normas de instalação aplicáveis e as instruções do fabricante.

2014/35/UE: Low Voltage Directive 2014/30/UE: Electromagnetic Compatibility Directive

2011/65/UE: RoHS2 Directive

Está em conformidade com a(s) seguinte(s) norma(s) ou outro(s) documento(s) normativo(s):

IEC 61010-1:2010+AMD1:2016 CSV Ed.3.0 IEC 61326-1:2012 Ed. 2.0

IEC 61000-6-2:2016 Ed. 3.0 IEC 61000-6-4:2006+AMD1:2010 CSV Ed.2.1

UL 61010-1, 3rd Edition, 2012-5

Ano de marcação "CE":

2014

DICHIARAZIONE DI CONFORMITÀ UE

La presente dichiarazione di conformità viene rilasciata sotto la responsabilità esclusiva di CIRCUTOR, con sede in Vial Sant Jordi, s/n – 08232 Viladecavalls (Barcelona) Spagna

prodotto:

Analizzatori di reti pannello 96 x96

Série:

CVM-C5

MARCHIO:

CIRCUTOR

L'oggetto della dichiarazione è conforme alla pertinente normativa di armonizzazione dell'Unione Europea, a condizione che venga installato, mantenuto e utilizzato nell'ambito dell'applicazione per cui è stato prodotto, secondo le norme di installazione applicabili e le istruzioni del produttore.

2014/35/UE: Low Voltage Directive 2014/30/UE: Electromagnetic Compatibility Directive

2011/65/UE: RoHS2 Directive

È conforme alle seguenti normative o altri documenti normativi:

IEC 61010-1:2010+AMD1:2016 CSV Ed.3.0 IEC 61326-1:2012 Ed. 2.0

IEC 61000-6-2:2016 Ed. 3.0 IEC 61000-6-4:2006+AMD1:2010 CSV Ed.2.1

UL 61010-1, 3rd Edition, 2012-5

Anno di marcatura "CE":

2014



Viladecavalls (Spain), 17/10/2017
General Manager: Ferran Gil Torné



CIRCUTOR, SA – Vial Sant Jordi, s/n
08232 Viladecavalls (Barcelona) Spain
(+34) 937 452 900 – info@circutor.com

**DEKLARACJA ZGODNOŚCI UE**

Niniejsza deklaracja zgodności zostaje wydana na wyłączną odpowiedzialność firmy CIRCUTOR z siedzibą pod adresem: Vial Sant Jordi, s/n – 08232 Viladecavalls (Barcelona) Hiszpania

produkt:

analityzator sieciowy tablicowy 96x96

Seria:

CVM-C5

marka:

CIRCUTOR

Przedmiot deklaracji jest zgodny z odnośnymi wymaganiami prawodawstwa harmonizacyjnego w Unii Europejskiej pod warunkiem, że będzie instalowany, konserwowany i użytkowany zgodnie z przeznaczeniem, dla którego został wyprodukowany, zgodnie z mającymi zastosowanie normami dotyczącymi instalacji oraz instrukcjami producenta

2014/35/UE: Low Voltage Directive 2014/30/UE: Electromagnetic Compatibility Directive

2011/65/UE: RoHS2 Directive

Jest zgodny z następującą(y)mi) normą(ami) lub innym(i) dokumentem(ami) normatywnym(i):

IEC 61010-1:2010+AMD1:2016 CSV Ed 3.0 IEC 61326-1:2012 Ed 2.0
IEC 61000-6-2:2016 Ed 3.0 IEC 61000-6-4:2005+AMD1:2010 CSV Ed 2.1
UL 61010-1, 3rd Edition, 2012-5

Rok oznakowania "CE":

2014



Viladecavalls (Spain), 17/10/2017
General Manager: Ferran Gil Torné

CIRCUTOR, SA

Vial Sant Jordi, s/n

08232 - Viladecavalls (Barcelona)

Tel.: (+34) 93 745 29 00 - Fax: (+34) 93 745 29 14

www.circutor.com central@circutor.com