

Up to 120 l/min  
Up to 420 bar

## FUNCTION

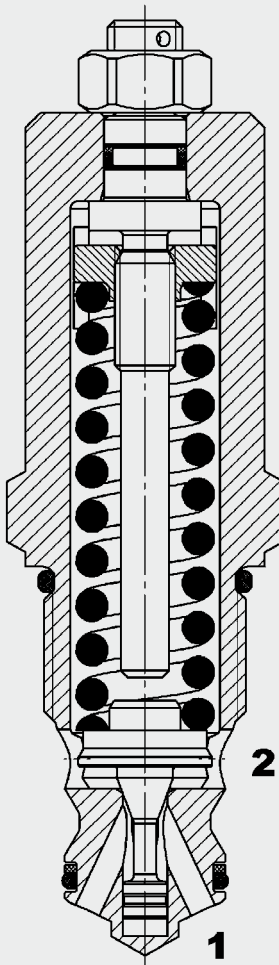

The pressure relief valve DB12120A is a direct-acting, spring-loaded poppet valve. Its function is to relieve pressure in the system. It is normally closed. If the pressure at port 1 exceeds the pre-set spring tension, the poppet is lifted off the seat and oil flows from port 1 to port 2.

This continues until the system pressure is equal to the spring tension and the valve closes again.

Important: Pressures at port 2 are additive to the opening pressure! If the connections are incorrect or if the pressure has been set above the operating pressure, the safety function of the valve is disabled.

## Pressure Relief Valve Poppet Type, Direct-Acting Metric Cartridge – 420 bar DB12120A

### FEATURES

- Excellent stability throughout the entire flow range
- External surfaces zinc-plated and corrosion-proof
- Hardened and ground internal valve components to ensure minimal wear and extended service life
- Low pressure drop by CFD optimized flow path
- Various pressure ranges up to 420 bar

### SPECIFICATIONS

Operating pressure:	max. 420 bar max. 100 bar at port 2 (tank)
Nominal flow:	max. 120 l/min
Pressure setting ranges:	5 to 30 bar 30 to 55 bar 55 to 90 bar 10 to 150 bar 10 to 250 bar 10 to 350 bar 10 to 420 bar
Media operating temperature range:	min. -20 °C to max. +120 °C
Ambient temperature range:	min. -20 °C to max. +120 °C
Operating fluid:	Hydraulic oil to DIN 51524 Part 1 and 2
Viscosity range:	min. 7.4 mm <sup>2</sup> /s to max. 420 mm <sup>2</sup> /s
Filtration:	Class 21/19/16 according to ISO 4406 or cleaner
MTTF <sub>d</sub> :	150 years (see "Conditions and instructions for valves" in brochure 5.300)
Installation:	No orientation restrictions
Materials:	Piston: hardened and ground steel Seals: FKM (standard) NBR (optional, media temperature range -30 °C to +100 °C) Back-up rings: PTFE
Cavity:	12120A
Weight:	0.42 kg

## DIMENSIONS

Adjustmt type F Adjustmt type V Adjustmt type PP

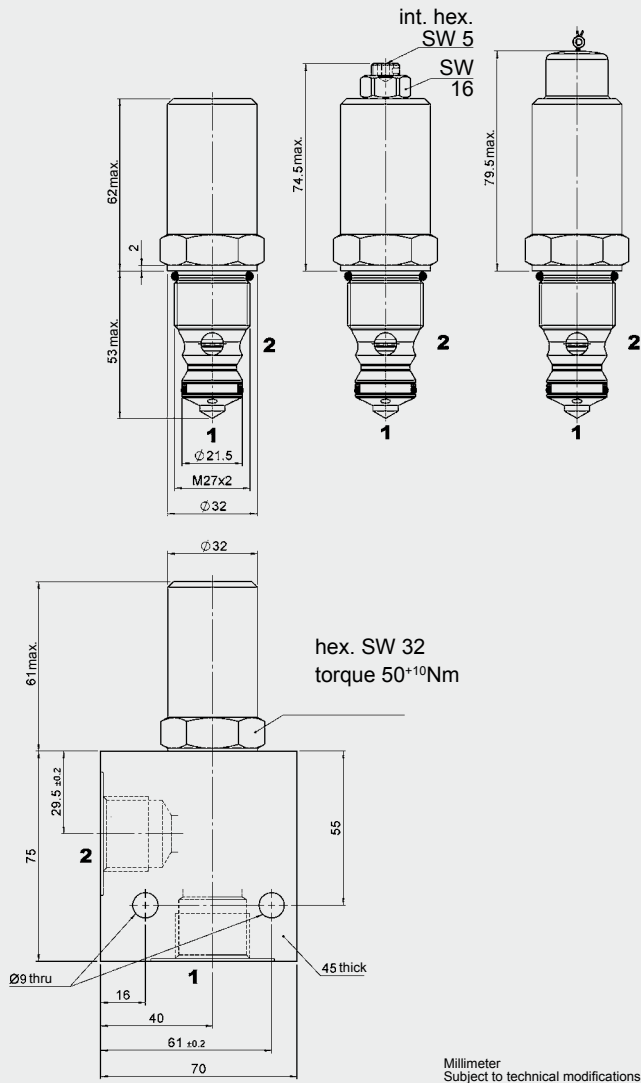

## CAVITY

12120A

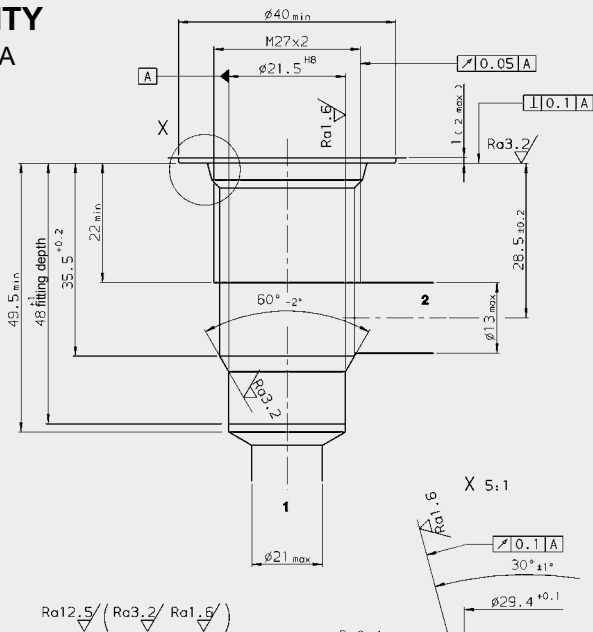

## Form tools

Tool	Part No.
Countersink MK3	173958
Reamer MK2	174874
Tap	1002625

Millimeter  
Subject to technical modifications

## MODEL CODE

DB 12120A - 01 X - 250 V 210

Basic model \_\_\_\_\_  
Pressure relief valve

Cavity to ISO \_\_\_\_\_  
12120A = 2-way, metric

Type \_\_\_\_\_  
01 = standard, zinc-plated

Series \_\_\_\_\_  
(determined by manufacturer)

Pressure setting range \_\_\_\_\_  
30 = 5 to 30 bar  
55 = 30 to 55 bar  
90 = 55 to 90 bar  
150 = 10 to 150 bar  
250 = 10 to 250 bar  
350 = 10 to 350 bar  
420 = 10 to 420 bar  
Other pressure ranges on request

Type of adjustment \_\_\_\_\_  
V = Allen head  
P = can be lead-sealed, adjustable with tool (with plug)  
Other types of adjustment on request

Opening pressure setting \_\_\_\_\_  
No details = no setting, spring relaxed  
210 = opening pressure in bar, factory-set  
Other pressure settings on request

## Standard models

Model code	Part No.
DB12120A-01X-030V	555785
DB12120A-01X-055V	3117096
DB12120A-01X-090V	3494786
DB12120A-01X-150V	552805
DB12120A-01X-250V	552806
DB12120A-01X-350V	552807
DB12120A-01X-420V	552836

## Standard in-line bodies

Code	Part No.	Material	Ports	Pressure
R12120A-01X-01	396489	Steel, zinc-plated	G 3/4	420 bar

Other line bodies on request

## Seal kits

Code	Material	Part No.
SEAL KIT DB12120A-01X-...V	FKM	557399

# PERFORMANCE

Measured at  $v = 33 \text{ mm}^2/\text{s}$ ,  $T_{\text{oil}} = 46 \text{ }^\circ\text{C}$

## Pressure range ... 30 bar

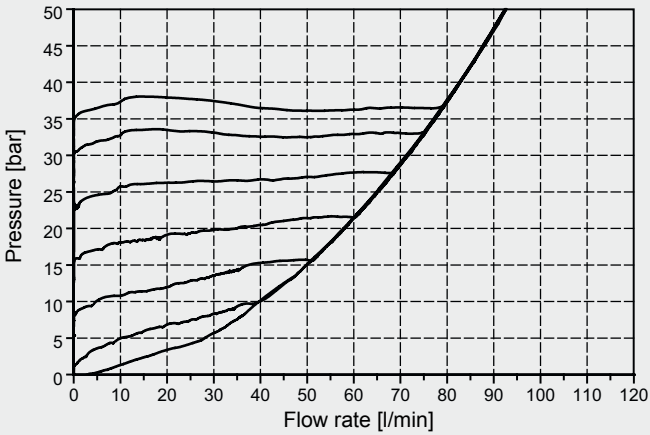

## Pressure range ... 55 bar

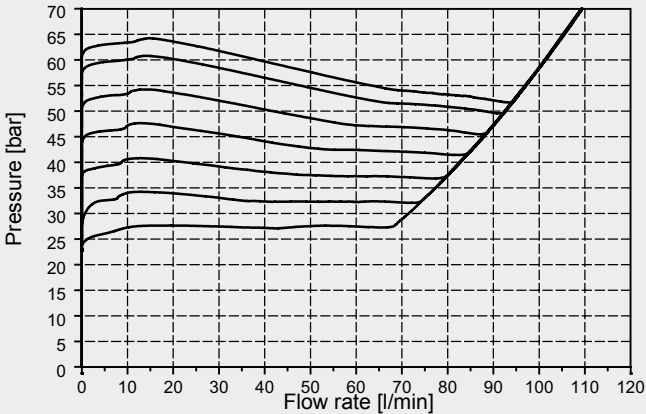

## Pressure range ... 90 bar

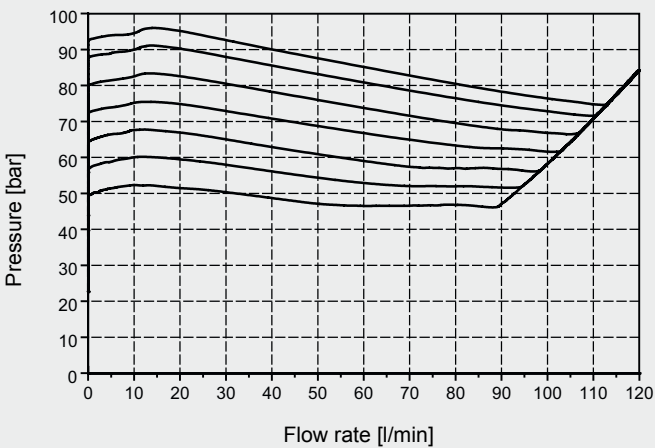

## Pressure range ... 150 bar

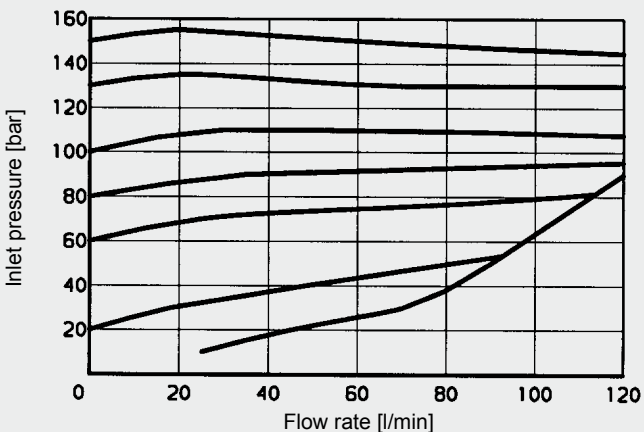

## Pressure range ... 250 bar

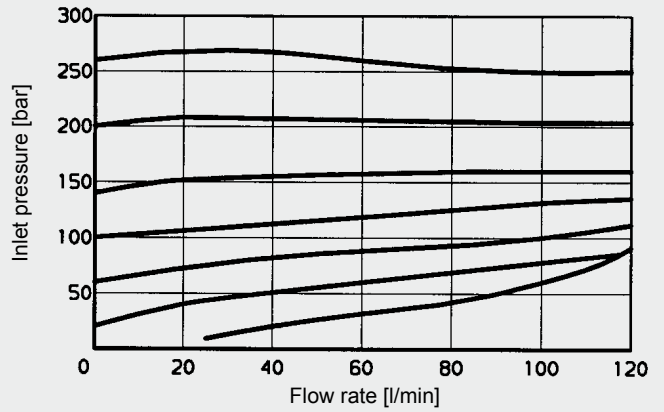

## Pressure range ... 350 bar

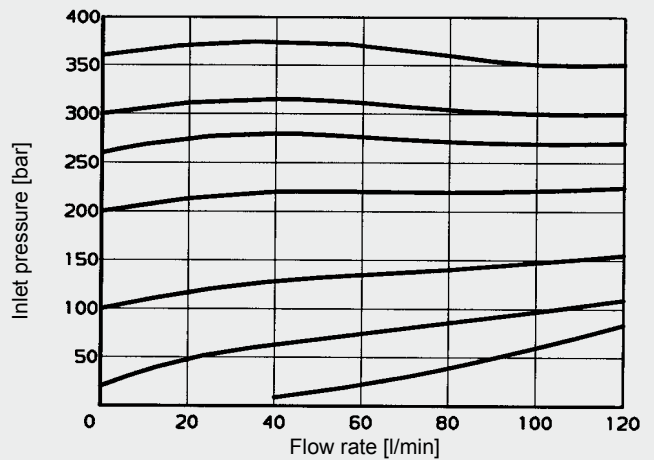

## Pressure range ... 420 bar

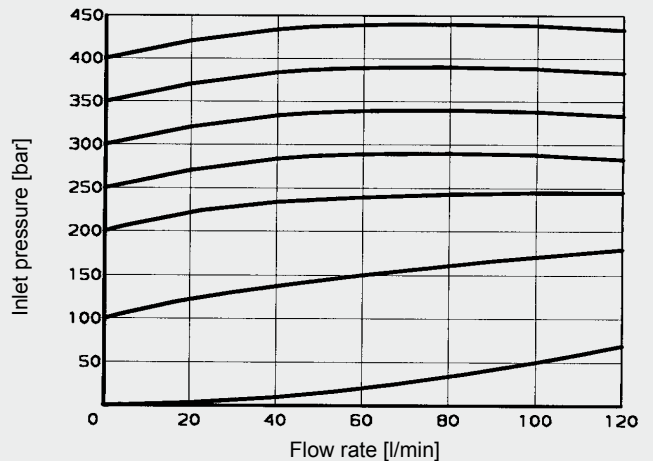

### NOTE

The information in this brochure relates to the operating conditions and applications described. For applications or operating conditions not described, please contact the relevant technical department. Subject to technical modifications.

**HYDAC Fluidtechnik GmbH**  
 Justus-von-Liebig-Str.  
 D-66280 Sulzbach/Saar  
 Tel: 0 68 97 / 509-01  
 Fax: 0 68 97 / 509-598  
 E-Mail: flutec@hydac.com

