

RLA108/0042-3030LH

AC centrifugal fan

forward-curved, single-intake

with housing (without flange), Gas blower for conventional heating

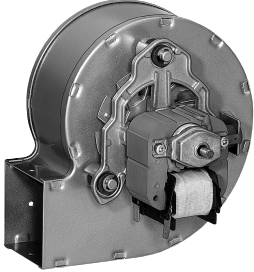

ebm-papst Landshut GmbH

Hofmark-Aich-Straße 25

D-84030 Landshut

Phone +49 (0) 871 707-0

Fax +49 (0) 871 707-465

info3@de.ebmpapst.com

www.ebmpapst.com

Nominal data

Type	RLA108/0042-3030LH	
Phase		1~
Nominal voltage	VAC	230
Frequency	Hz	50
Speed	min ⁻¹	1870
Power consumption	W	64
Current draw	A	0.52
Max. temp. of flow medium	°C	250
Air flow	m ³ /h	140
Pressure increase	Pa	290

ml = Max. load · me = Max. efficiency · fa = Free air · cs = Customer specification · ce = Customer equipment
Subject to change



RLA108/0042-3030LH

AC centrifugal fan

forward-curved, single-intake

with housing (without flange), Gas blower for conventional heating

Technical description

Weight	1.6 kg
Impeller material	Fire-aluminized sheet steel
Housing material	Fire-aluminized sheet steel
Insulation class	"H"
Cable	Flat plug 6.3 x 0.8



RLA108/0042-3030LH

AC centrifugal fan

forward-curved, single-intake

with housing (without flange), Gas blower for conventional heating

Product drawing

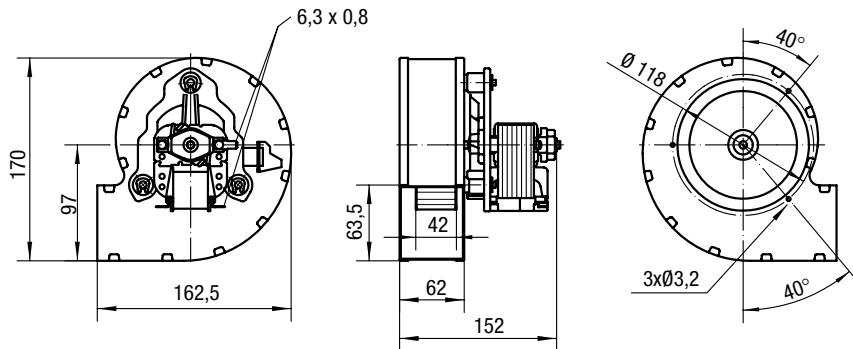

AC centrifugal fan

forward-curved, single-intake

with housing (without flange), Gas blower for conventional heating

Curves: Air performance

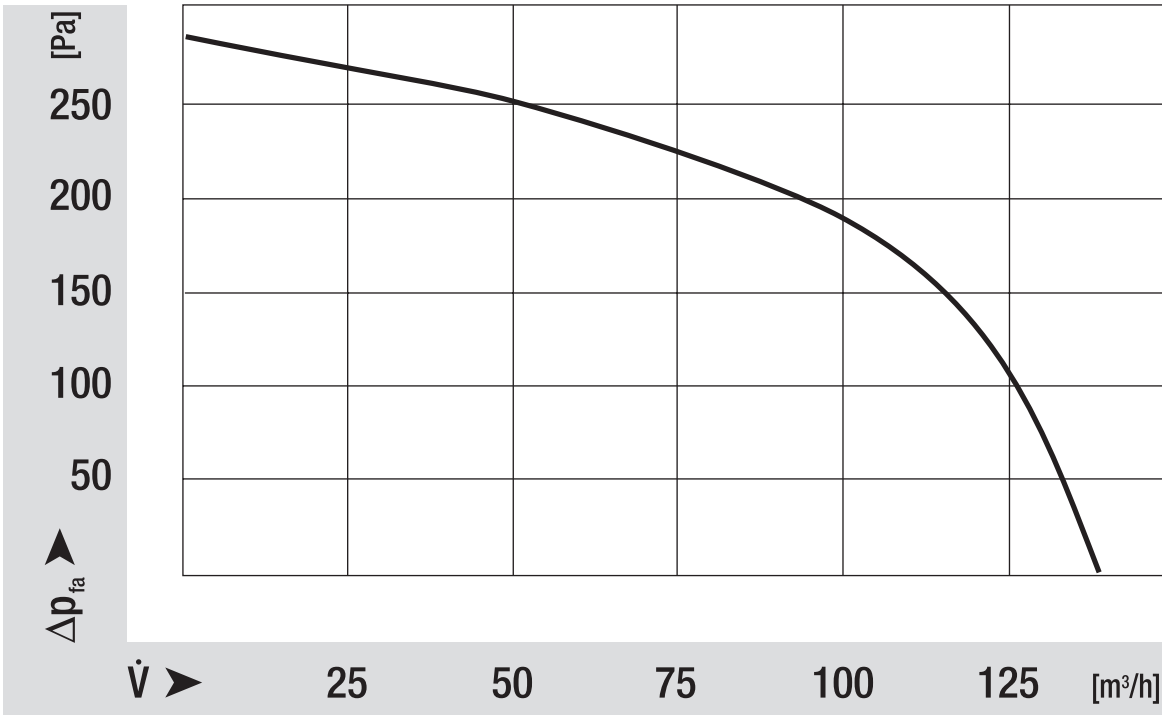

AC centrifugal fan

forward-curved, single-intake

with housing (without flange), Gas blower for conventional heating

Curves: Speed

