

Electronics



**Microprocessor operated
burner control device**

ESA ESTRO (E7014 rev. 03 - 22/10/2010)

GENERAL WARNINGS:



- All installation, maintenance, ignition and setting must be performed by qualified staff, respecting the norms present at the time and place of the installation.
- To avoid damage to people and things, it is essential to observe all the points indicated in this handbook. The reported indications do not exonerate the Client/User from observing general or specific laws concerning accidents and environmental safeguarding.
- The operator must wear proper DPI clothing (shoes, helmets...) and respect the general safety, prevention and precaution norms.
- To avoid the risks of burns or high voltage electrocution, the operator must avoid all contact with the burner and its control devices during the ignition phase and while it is running at high temperatures.
- All ordinary and extraordinary maintenance must be performed when the system is stopped.
- To assure correct and safe use of the combustion plant, it is of extreme importance that the contents of this document be brought to the attention of and be meticulously observed by all personnel in charge of controlling and working the devices.
- The functioning of a combustion plant can be dangerous and cause injuries to persons or damage to equipment. Every burner must be provided with certified combustion safety and supervision devices.
- The burner must be installed correctly to prevent any type of accidental/undesired heat transmission from the flame to the operator or the equipment.
- The performances indicated in this technical document regarding the range of products are a result of experimental tests carried out at ESA-PYRONICS. The tests have been performed using ignition systems, flame detectors and supervisors developed by ESA-PYRONICS. The respect of the above mentioned functioning conditions cannot be guaranteed if equipment, which is not present in the ESA-PYRONICS catalogue, is used.

DISPOSAL:



To dispose of the product, abide by the local legislations regarding it.

GENERAL NOTES:



- In accordance to the internal policy of constant quality improvement, ESA-PYRONICS reserves the right to modify the technical characteristics of the present document at any time and without warning.
- It is possible to download technical sheets which have been updated to the latest revision from the www.esapyronics.com website.
- The products manufactured by ESA-PYRONICS have been created in conformity to the **UNI EN 746-2:2010** Norms: Equipment for industrial thermal process - Part 2: Safety requirements for combustion and the movement and treatment of combustible elements. This norm is in harmony with the Machine Directive **2006/42/CE**. It is certified that the products in question respect all the requirements prescribed by the above mentioned Norms and Directives.
- Certified in conformity with the **UNI EN ISO 9001** Norm by DNV GL.

CERTIFICATIONS:



ESA ESTRO complies to the **EN298** as certificate 17800 issued by notify body 0694. ESA ESTRO is in accordance to European Union directives: Directive on appliances burning gaseous fuels **2009/142/CE**, Low voltage directive **2006/95/CEE**, Electromagnetic Immunity **2004/108/CE**, in conjunction with **EN298**, **EN230** and **EN746-2**.

The products conform to the American standards requirements according to the **CSA US**.

The products conform to the requests for the Euroasia market (Russia, Belarus and Kazakhstan).

The products conform to the Australian standards requirements according to the **AGA**.



ESA ESTRO is a microprocessor operated device, designed to control gas and oil fired burners, which are discontinuously operated. This device warrants the safe operation of the combustion unit at one or two stages (pilot/main burners), it controls the air flow rate and allows the detection of flame presence through ionization (electrodes) or UV radiation (UV-scan). ESA ESTRO is equipped for serial communication, allowing a remote burner control and operation. The thermal resistant case of ESA ESTRO allows its installation on burner proximity, provided that the environment temperature remains below 60°C.

APPLICATIONS

- One or two stage (pilot/main) discontinuous burners.
- Flame detection by means of rod, unirod and UV scan (also combined).
- Packaged burners managing a complete ignition cycle (blower, air damper, air pressure switch).
- Burners with air valve control for furnace purging, burner ignition and thermoregulation (heating/cooling) via external regulation device.
- Combustion plant with burner controller via digital signal or ECS serial communication.
- Customized burner operation through programmable expansion cards.



F7014103

CHARACTERISTICS

MAIN:

- Voltage supply: 115 Vac or 230 Vac +10 ÷ -15%
- Frequency: 45÷65 Hz
- Power supply mode: phase-neutral, non suitable for phase-phase
- Neutral type: suitable for ground as well as non ground neutral connection
- Power consumption without outlets: 5 VA max
- Operating temperature: 0÷60 °C
- Storage temperature: -20÷80 °C
- Protection class: IP54 (when wiring, use adequate connectors)
- Mounting position: any
- Installation environment: not suitable for ATEX classified area and corrosive area
- Case: Thermosetting with fiberglass
- Size: 200×120×93 mm
- Weight: 1.300 g
- Approvals according EN298 and EN230: BOOLXN programmable



F7014104

CHARACTERISTICS

INPUT AND OUTPUT CONNECTIONS:

■ Flame detection probe voltage:	max 300 Vac
■ Minimum ionization current:	2,4 μ A \pm 0,3 μ A
■ Flame probe current limit:	1 mA
■ Flame signal display:	0 \div 90 μ A
■ Flame probe type:	electrode or UV scan model ESA UV-2
■ Rod or UV scan probe line length:	< 30 m
■ High voltage ignition transformer line length:	2 m max
■ Insulation among probe conductors:	> 50 M Ω (double-insulation or double-protection cables)
■ Digital input signal voltage:	same as supply voltage
■ Digital input power consumption:	max 5mA
■ Filter for lock/reset input:	RC 100 Ω - 0,47 μ F - 250 Vac
■ Output signal voltage:	same as supply voltage
■ Current per each output signal:	1.5 A
■ Current per output signals (total):	4 A per 10 sec. / min.
■ Load protection fuse:	4 A fast
■ Device protection fuse:	1 A non replaceable
■ Supply voltage expansion card EXP-2 and EXP-4:	24 Vac, 115 Vac, 230 Vac
■ Supply voltage expansion card EXP-2 and EXP-4:	max 5mA
■ Power absorption expansion card EXP-2 and EXP-4:	same as supply voltage
■ Output signal voltage expansion card EXP-2 and EXP-4:	4 A (unprotected by inner fuse)

PARAMETERS:

■ Pre-purge time:	0 \div 255 s
■ First safety time*:	1 \div 25 s
■ Main burner stabilization time*:	0 \div 25 s
■ Reaction time*:	1 \div 20 s
■ Post-purge time:	0 \div 255 s
■ Accepted unlocking:	5 max in 15 min
■ Auto shutoff (can be inhibited)*:	1 minimum in 24 hours
■ Action at missing flame signal:	programmable
■ First gas stage actions:	programmable
■ Air valve operation:	programmable

* These parameters must comply to the norms and directives related to the industrial process wherein ESA ESTRO is adopted as a burner control device.

DESCRIPTION

ESA ESTRO is a device based on microprocessor technology, provided with input and output connections, suitable to control discontinuous burner operation (at least one burner shutoff every 24 hours). The instrument is available in four different versions.

- **ESA ESTRO-A:** single stage burner (one gas valve) with air valve operation control. The configuration software allows the proper definition of the air valve operation.

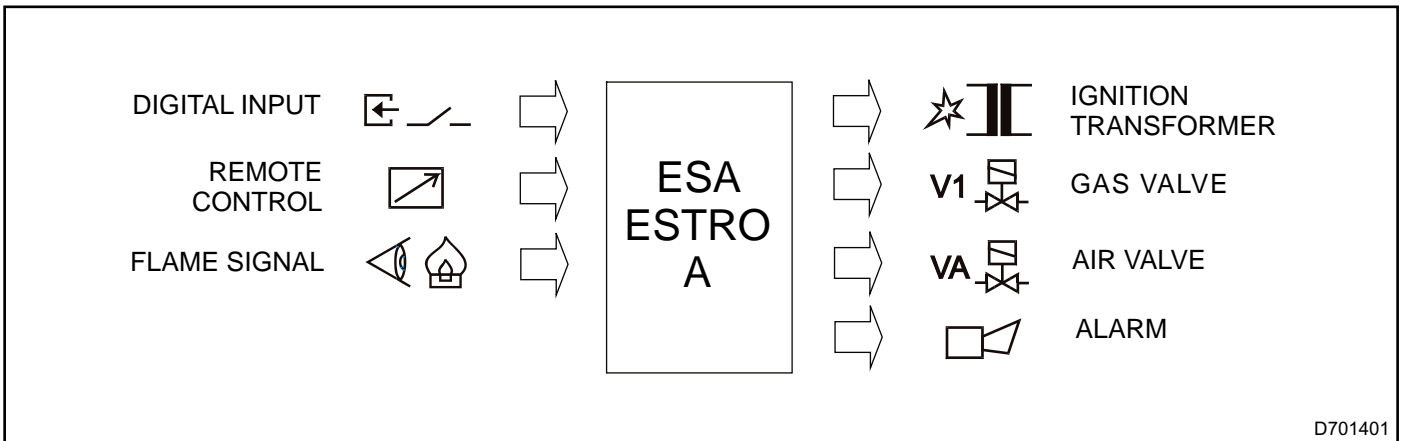

- **ESA ESTRO-B:** two stage burners (1st pilot, 2nd main). The configuration software sets the operation of the pilot burner (1st stage) in continuous or discontinuous mode.

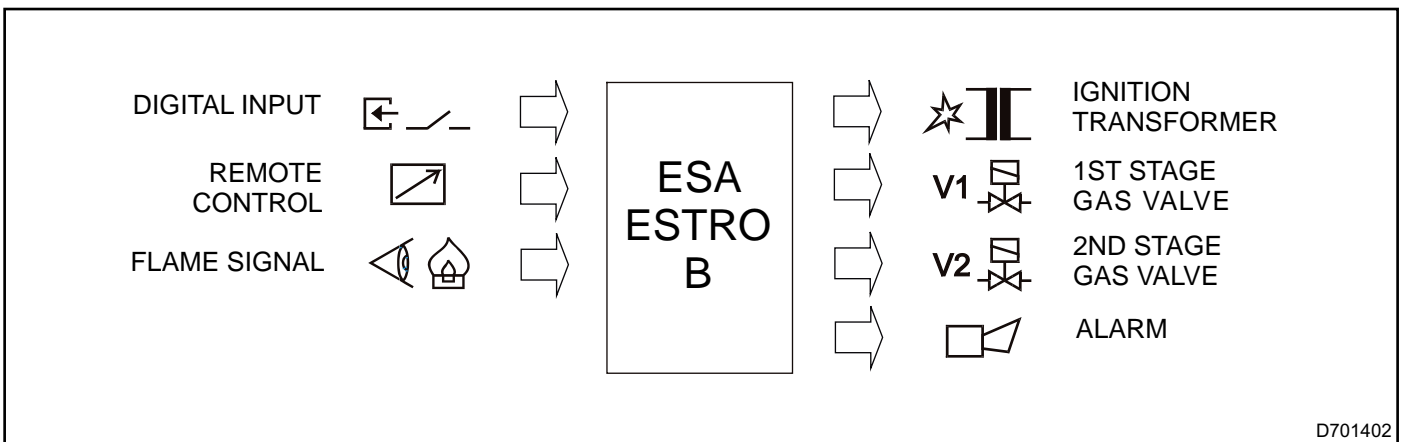

- **ESA ESTRO-C:** single stage burner (one gas valve) with output signal for burner "ON" indication.

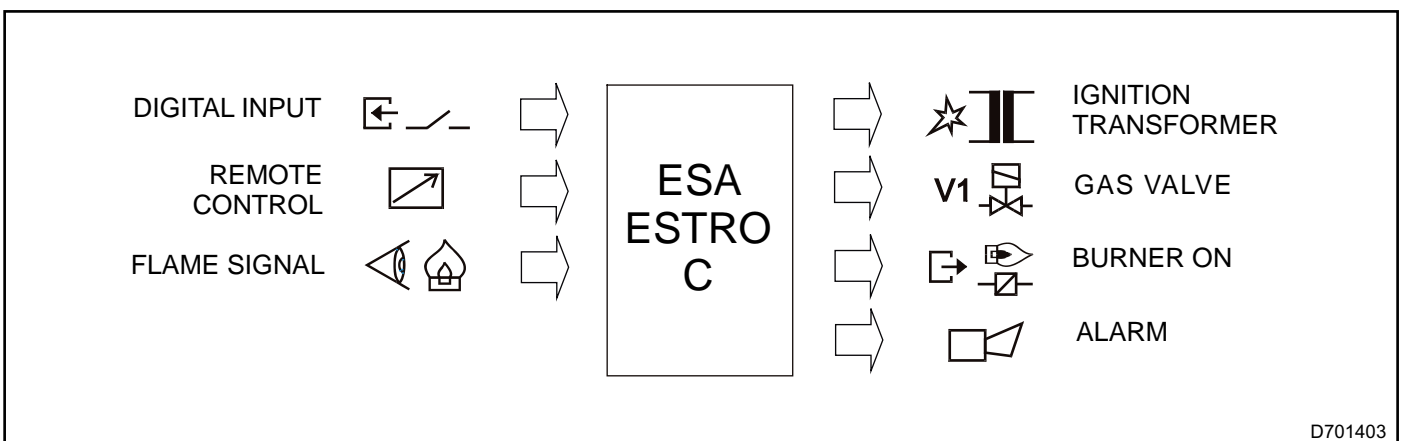

- **ESA ESTRO-Q:** single stage burner (one gas valve) dedicated to combustion unit controlled via serial communication modes.

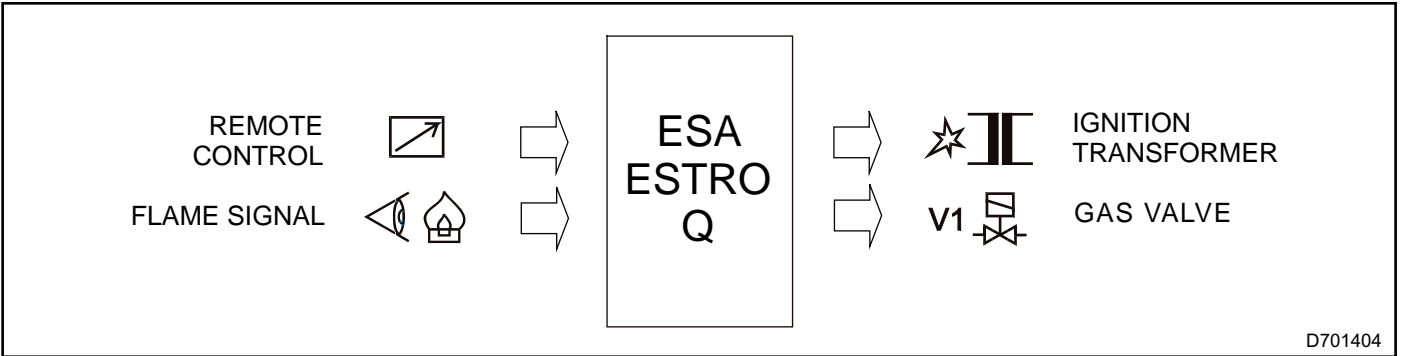

D701404

Moreover the ESTRO-A, B and C versions allow the setting of an output signal for burner lockout and a digital input signal. The input signal availability is mandatory (according EN746-2) for high temperature applications in order to accomplish the dedicated function. All ESA ESTRO versions are currently provided with ECS serial

communication interface, in order to allow the remote burner control through ESA ECS or Modbus-RTU protocols. The serial communication allows the complete control of the combustion unit: burner ignition and shutoff, first and second gas stage operations, air valve control, burner supervision and flame detection.

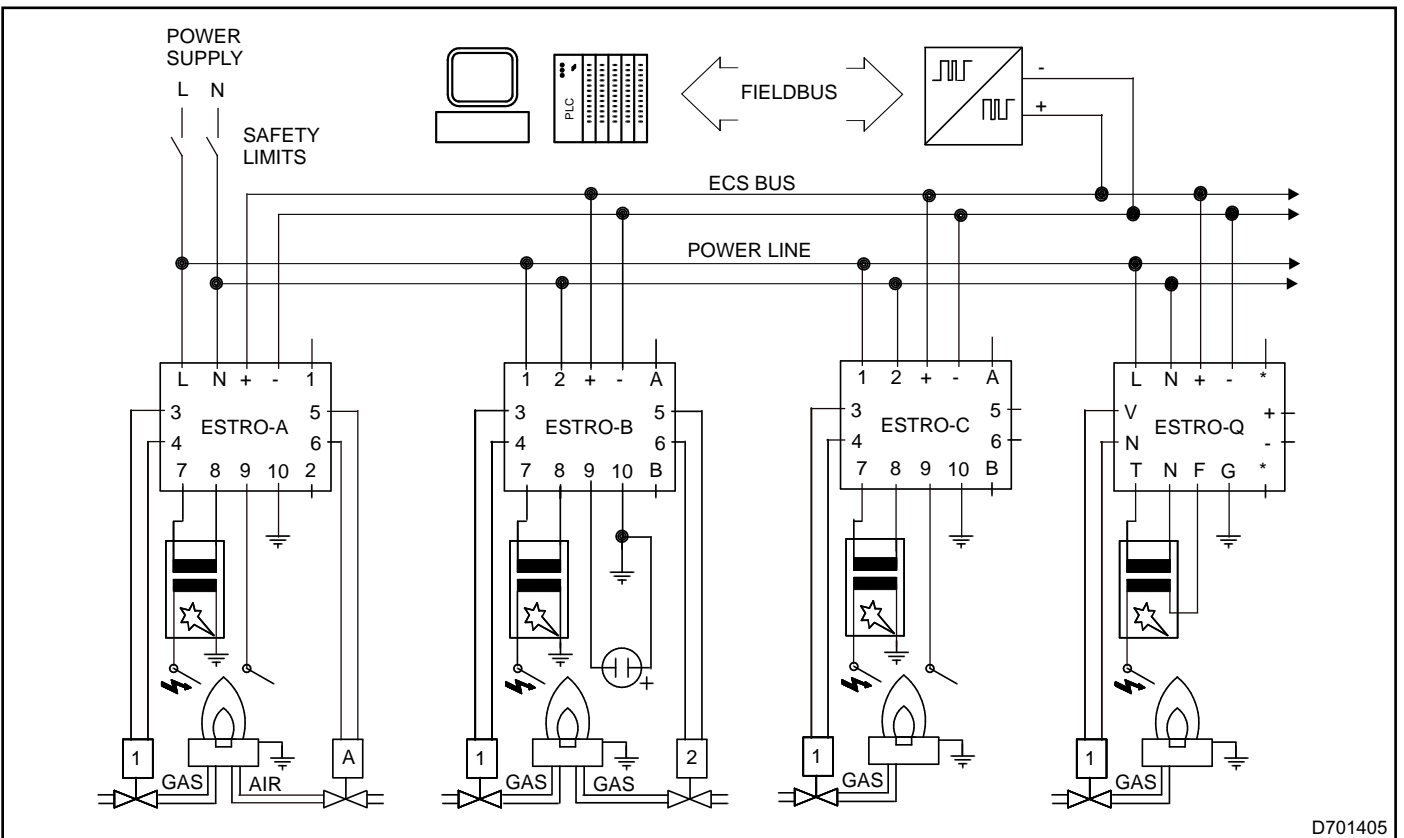

D701405

On its front panel ESA ESTRO mounts a programmable push button, an alphanumeric display of status indication, a bargraph flame signal indicator and the infrared communication port for the "on field" configuration of the instrument. Dedicated configuration software allows the definition of several operation parameters, according to process requirements, like the control of the air valve,

the lockout output signal, the scheduled time for each phase (according to the ranges defined by the reference norms). ESA ESTRO is provided with a solid case in a thermosetting composition, prepared for the ignition transformer and the output wires for external connections. Dedicated Expansion cards can be connected to each ESA ESTRO version, in order to implement additio-

nal features or specific serial communication modes. The installation of an expansion card in the ESA ESTRO device obliges to install the ignition transformer into an

external thermostetting case named ESA TRAF0. Hereinafter the expansion cards available are described according to their main characteristics:

■ **ESA EXP-2:** dedicated to "package burners", controls the air valve or blower start, verifies the air pressure switch signal and operates the initial purging and burner ignition procedures. Expansion card EXP-2 can also be adopted to simply operate the air valve (for device versions which differ from ESTRO-A).

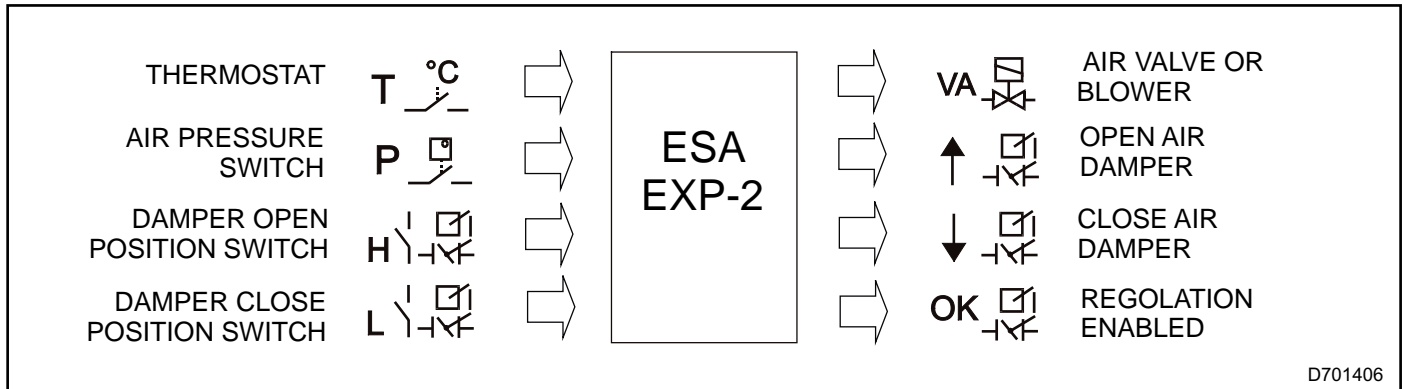

■ **ESA EXP-3:** developed to implement serial communication with the most common fieldbus standards. For detailed information please refer to the technical sheet E7015.

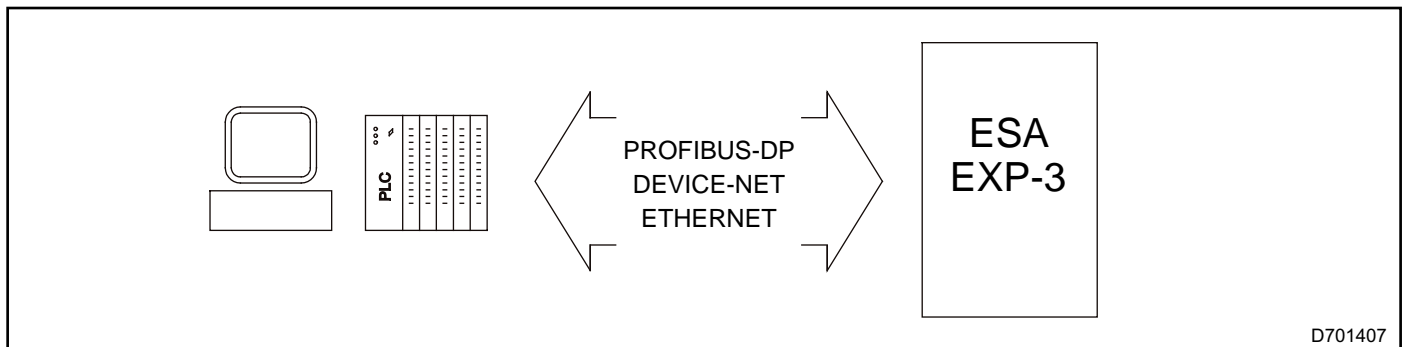

■ **ESA EXP-4:** provided with four digital inputs, four digital outputs, one similar input, one similar output and a serial interface in order to allow remote card control. For detailed information please refer to the technical sheet E7016.

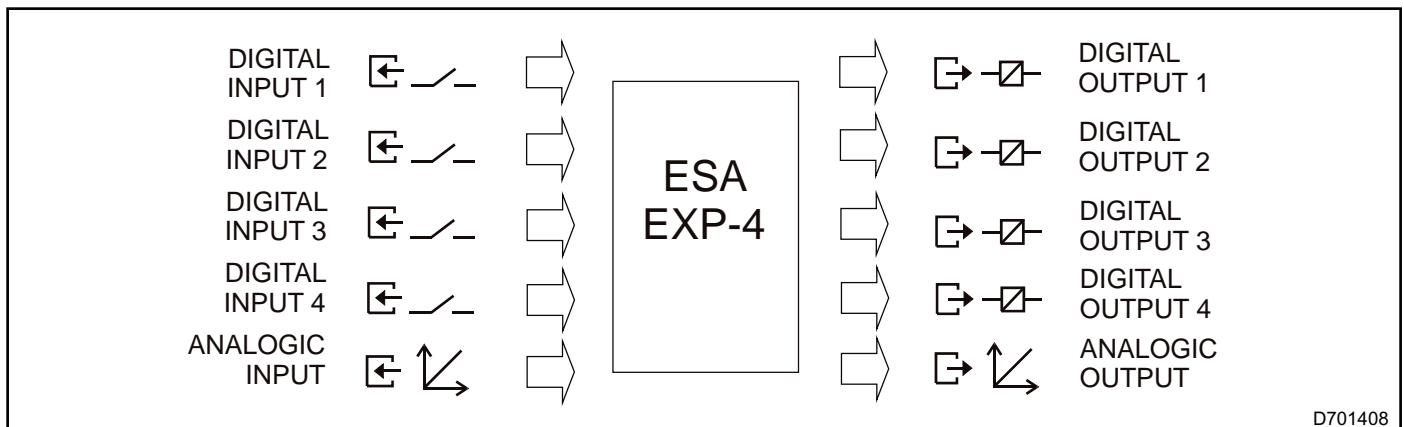

ALPHANUMERIC VISUALIZATION AND PUSH BUTTON

DISPLAY

ESA ESTRO displays the status of the burner control device through several symbols. Fixed characters indicate the normal operating conditions or some instrument failures that cannot be restored, while lockout conditions or restorable failures are indicated with blinking symbols.













Normal operation stages









DISPLAY	INDICATION	DESCRIPTION
8	FIXED	Self-diagnosis phase; the equipment controls the efficiency of its components. It is shown every time the equipment is powered or when the burner is re-started (it lasts about 2 sec).
5	BLINKING	Manual lockout. The equipment is waiting for the operator's reset command via the local, remote or serial button. It is shown every time the equipment is powered in case the parameter "Power on" is configured as "Stand-by".
E	FIXED	Burner shut-off caused by the temp controller. The instrument leads to the burner in "off" mode, close the air valve and deactivates other exits.
A	FIXED	Air pressure switch signal waiting phase after air valve activation (or blower start), or burner shut-off during operation in case of incorrect air pressure signal. It is shown with expansion cards in case the parameter "Air switch" is configured as "Waiting".
n	FIXED	Initial purging: air valve is opening and the maximum opening position is not yet reached (position switch). It is shown with expansion cards in case the parameter "Air damper" is configured as "Local or Remote".
p	FIXED	Purge or waiting time before burner ignition. For applications with controlled cooling slope, only the air valve is open in this phase. At this stage the device verifies the presence of illegal flames and if necessary generates a shut-off reaction.
u	FIXED	Initial purging: air valve is closing and the minimum opening position is not yet reached (position switch) to warrant ignition at minimum firing rate. It is shown with expansion cards in case the parameter "Air damper" is configured as "Local or Remote".
1	FIXED	Burner ignition at 1st stage, it lasts as long as the first safety time. The device activates the ignition transformer and the 1st stage gas valve, then deactivates the transformer and verifies the flame presence.
2	FIXED	Check of flame stability at 1st stage, followed by the flame's amplifier control. This phase is shown also in case of the shut-off of the 2nd stage burner.
3	FIXED	Normal operation stage for ESTRO-A, ESTRO-C and ESTRO-Q. For the ESA ESTRO-B version it signals the 2nd stage gas burner and it lasts as long as the second safety time. In this phase both 1st and 2nd gas valves are activated. This is the normal operation stage also for ESA ESTRO-B in case the parameter "1st stage" is configured as "Intermittent".

DISPLAY	INDICATION	DESCRIPTION
4	FIXED	Normal operation stage for ESA ESTRO-B with only 2nd stage gas burner activated. The device closes the 1st stage gas valve. This phase is present only in case the parameter "1st stage" is configured as "Interrupted".
6	FIXED	Normal operation stage with air valve activated. In case the parameter "Air switch" is configured as "Lockout or Waiting" the device waits for the air pressure signal before showing this stage, while when configured as "Disable" the switch to this stage coincides with the air valve opening. This phase is present only in case the parameter "Air flow control type" is configured as "Discontinue or Pulse".
9	FIXED	The device verifies the flame's complete extinguishment in a maximum of 20 sec. after burner shut-off; otherwise a lockout signal for illegal flame presence is activated.
8.	FIXED POINT	Furnace purging with air (or waiting phase) after burner shut-off. During this phase the device doesn't accept any command and shows the symbol referred to the phase or block that activated the shut-off procedure.
H	FIXED	Burner shutoff phase requested by temp. controller. The device keeps the burner in "OFF" mode waiting for a new start signal, maintaining the air valve closed and deactivating the output signals.
8.	BLINKING POINT	High Temperature Operation mode active. During this phase the device shows the fixed code related to the active phase.

Lockouts or failures



DISPLAY	INDICATION	DESCRIPTION
0	BLINKING	Manual burner shut-off, generated through local or remote push button during the normal operation stage. The device keeps the burner in "OFF" mode waiting for a new start signal.
d	BLINKING	Lockout due to a signal of illegal flame presence, before the burner ignition or after burner shut-off. The causes could be related to the detection device (failure) or to a fuel gas leak through the interception solenoid valves.
U	BLINKING	Lockout due to a failed burner ignition attempt at 1st gas stage. The causes could be related to the ignition devices (electrode and/or transformer), to incorrect air/fuel ratio gases, or to the flame detection device (probe or wiring failure). In the first mentioned case the burner is not ignited, vice-versa, in the second the flame is present but ESA ESTRO is unable to detect it.
F	BLINKING	Lockout due to a missing flame presence signal during the normal operation stage. The causes could be related to an incorrect air/fuel ratio (too rapid flow variations or ratios out of the flame stability range), or to the flame detection device (probe position or cleanliness).

DISPLAY	INDICATION	DESCRIPTION
	BLINKING	Lockout due to the extended absence of serial signals from the remote controller, for a longer period of time than the parameter set as "Communication time out". The causes could be related to incorrect connections or to the serial communication management.
	FIXED	Malfunction due to the presence of the air pressure switch signal before the blower activation. The causes could be related to an incorrect pressure switch wiring or its failure.
	BLINKING	Lockouts due to a malfunctioning of the inner circuit for air pressure switch. If after attempting to reset, the indication is still present, the device has to be sent back to the manufacturer for inspection.
	BLINKING	Lockout due to the missing signal from the air pressure switch during normal operation stage. The causes could be related to a pressure switch failure or to some problems related to the air flow (i.e. filter obstruction).
	BLINKING	Lockout due to the presence of the signal of air valve complete opening ("maximum" position switch) before the device allows the valve opening. The causes could be related to an incorrect electrical wiring or to an incorrect air valve switch regulation.
	BLINKING	Lockout due to the presence of the signal of air valve complete closure ("minimum" position switch) before the device allows the valve closure. The causes could be related to an incorrect electrical wiring or to an incorrect air valve switch regulation.
	BLINKING	Malfunction due to the presence of the air pressure switch signal before the blower activation. The causes could be related to an incorrect pressure switch wiring or its failure.
	BLINKING	Lockout due to the missing electrical absorption from the ignition devices connected to ESA ESTRO (ignition transformer or solenoid valves). The causes could be related to an electrical connection interruption, to the failure of one of the ignition devices or to a protection fuse failure.
	BLINKING	Lockout due to a malfunctioning of the flame detection probe. The causes could be related: to a probe failure, to a short circuit between the probe or its connection to earth (burner body), to the reverse connection of UV tube ESA UV-2, to an incorrect connection or earthing of the device, or to strong currents on the furnace mass (welding in progress).
	BLINKING	Lockout due to a malfunction of the inner flame amplifier. If after attempting to reset, the indication is still present, the device has to be sent back to the manufacturer for inspection.
	BLINKING	Lockout due to a malfunction of the inner circuit related to the temp. controller. If after attempting to reset, the indication is still present, the device has to be sent back to the manufacturer for inspection.
	BLINKING	Lockout due to an error of the inner memory of the device. The failure could be temporary or definitive and the causes could be related to incorrect or inadequate electrical connections of the device. If after attempting to reset, the indication is still present, the device has to be sent back to the manufacturer for inspection.

DISPLAY	INDICATION	DESCRIPTION
	BLINKING	Lockout due to the missing communication with the installed expansion card (EXP-2 or EXP-4). The causes could be related to an incorrect configuration or a failure of the expansion card. A check of the card configuration is required; If after attempting to reset, the indication is still present, the device has to be sent back to the manufacturer for inspection.
	BLINKING	Lockout due to a malfunctioning of the inner relays. If after attempting to reset, the indication is still present, the device has to be sent back to the manufacturer for inspection.
	FIXED (1)	Malfunction of the local push button or of the digital input signal (for remote operation): they are fixed on the "pressed" position during the self-diagnosis phase. The causes could be related to the connection of the remote signal, to the absence of RC filter, or to a malfunctioning of the push button. In order to reset the alarm cut off the electrical supply to the device for few seconds.
	FIXED (1)	Malfunction due to corruption of the inner memory of the device or to a failure of the safety circuit. The failure could be temporary or definitive and the causes could be related to incorrect or inadequate electrical connections of the device. In order to reset the alarm cut off the electrical supply to the device for few seconds. If after attempting to reset, the indication is still present, the device has to be sent back to the manufacturer for inspection.
	FIXED (1)	Malfunction due to short-circuit of the inner safety circuit relays. In order to reset the alarm cut off the electrical supply to the device for few seconds. If after attempting to reset, the indication is still present, the device has to be sent back to the manufacturer for inspection.
	FIXED (1)	Malfunction due to short-circuit of the microprocessors' pins. In order to reset the alarm cut off the electrical supply to the device for few seconds. If after attempting to reset, the indication is still present, the device has to be sent back to the manufacturer for inspection.
	FIXED (1)	Malfunction due to a jump code program. The failure could be temporary or definitive and the causes could be related to incorrect or inadequate electrical connections of the device. In order to reset the alarm cut off the electrical supply to the device for few seconds. If after attempting to reset, the indication is still present, the device has to be sent back to the manufacturer for inspection.
	DISPLAY AND BARGRAPH BLINKING	Malfunction due to a jump code program. The failure could be temporary or definitive and the causes could be related to incorrect or inadequate electrical connections of the device. In order to reset the alarm cut off the electrical supply to the device for few seconds. If after attempting to reset, the indication is still present, the device has to be sent back to the manufacturer for inspection.

(1): The indication of these failures or lockout conditions starts flashing when power is supplied again, indicating that alarm reset is possible.

Configuration

DISPLAY	INDICATION	DESCRIPTION
	FIXED	Configuration phase of the device via serial input (based on the dedicated software). During this phase the it is not possible to carry out any other operation.
	FIXED	Configuration phase of the device via infrared input (based on the dedicated software). During this phase the it is not possible to carry out any other operation.

BARGRAPH

ESA ESTRO is equipped with a 5 LED bargraph to show the value of flame detected signals in a range from 0 μ A to 90 μ A. In case of detection currents higher than 90 μ A all the LED remain lighted. The flame detection signals generated via an electrode (ionization) are normally lower than those generated via a UV scanner; nevertheless in both cases the bargraph shows the stability of the flame signal and therefore the reliability of the burner.

LOCAL PUSH BUTTON

ESA ESTRO allows the configuration of the push button operation according to its application requirements (see chapter Configuration). The push button may carry out

the manual operations of unlocking and shut-off, only manual unlocking, only manual shut-off and it can be deactivated in case of serial communication modes. According to its function the button action can be different:

- **Unlocking:** the push button has to be pressed for 1 to 3 sec. and when released it unlocks the ESA ESTRO.
- **Manual shutoff:** the push button immediately stops the ESA ESTRO when pressed.

ACTIONS

ESA ESTRO is a programmable device designed to control gas and oil fired burners in different modes according

to the process parameters set (see chapter Configuration). Hereinafter its main actions are described.

BURNER IGNITION CYCLE

The scheme describes the burner ignition cycle operation when ESA ESTRO is provided with an EXP-2 expansion card.

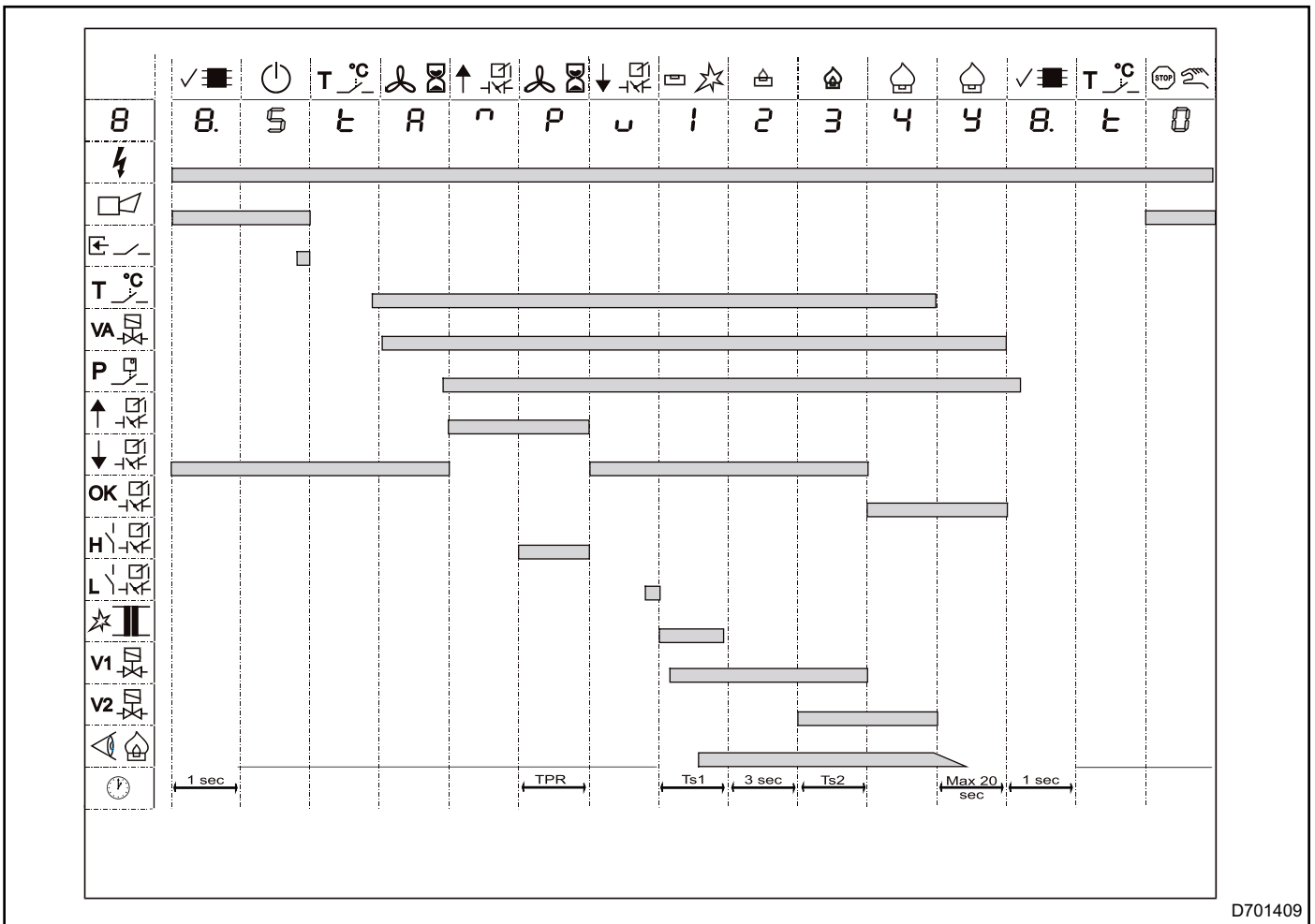

D701409

BURNER IGNITION CYCLE

The scheme describes the burner ignition cycle operation when ESA ESTRO is in standard version, without the EXP-2 expansion card.

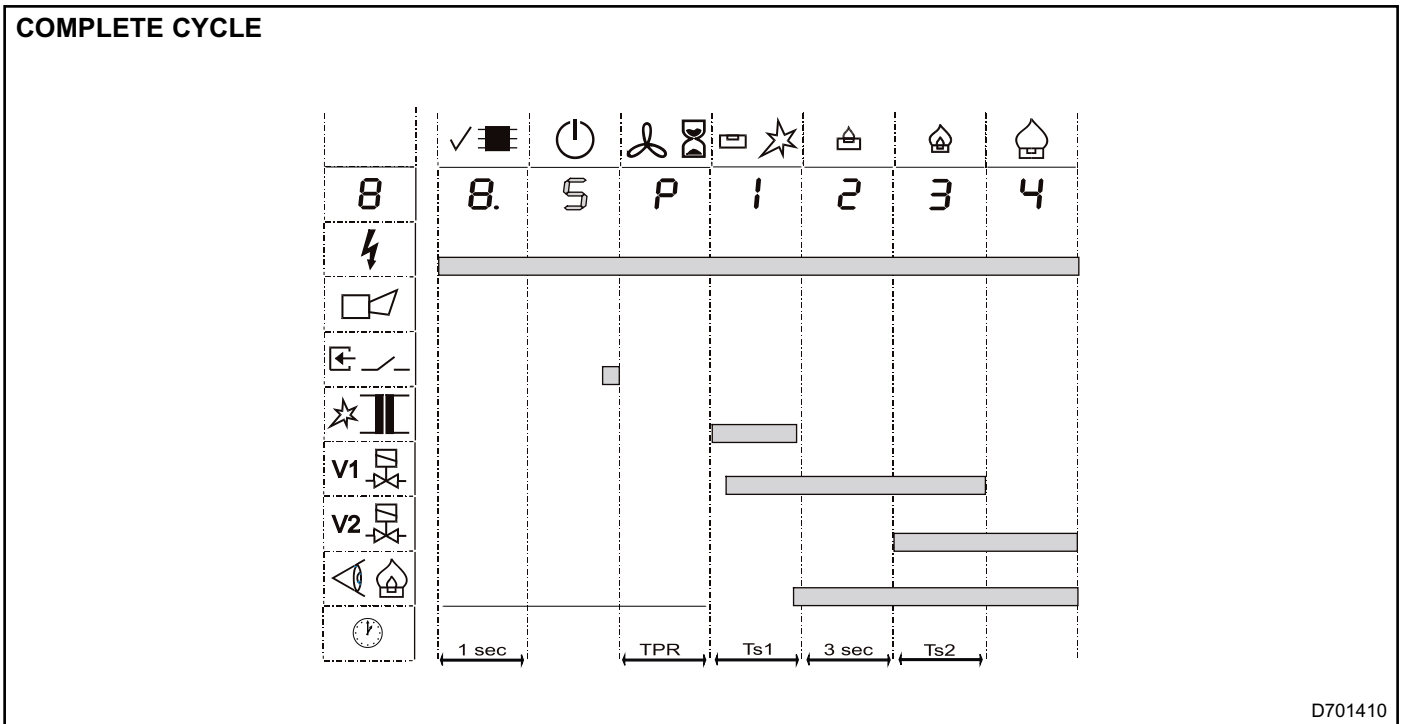

OPERATION AT POWER SUPPLY

The following schemes describe the ESA ESTRO actions at power supply, according to the configured parameter "Cycle start" if set as "Autostart" or as "Standby".

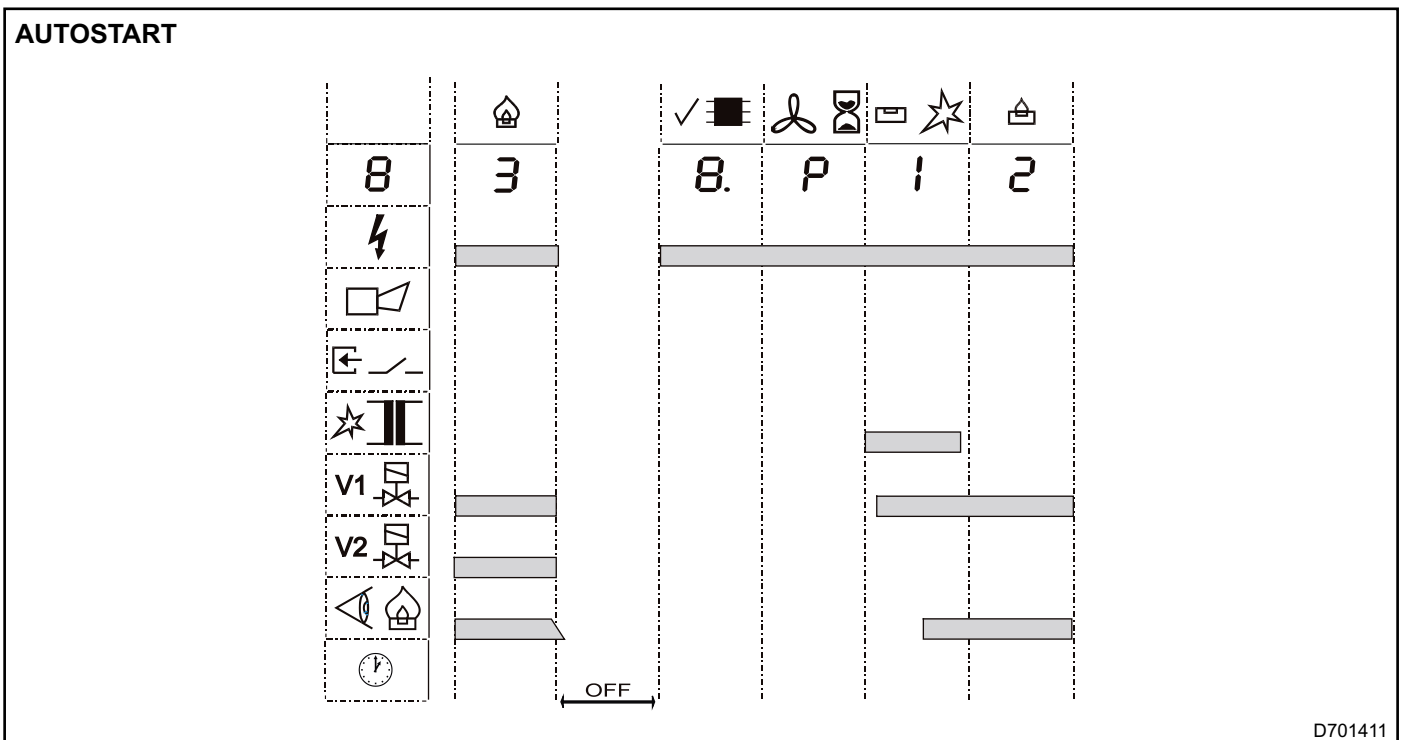

STANDBY

The following schemes describe the ESA ESTRO-B ignition cycle without expansion EXP-2 card version.

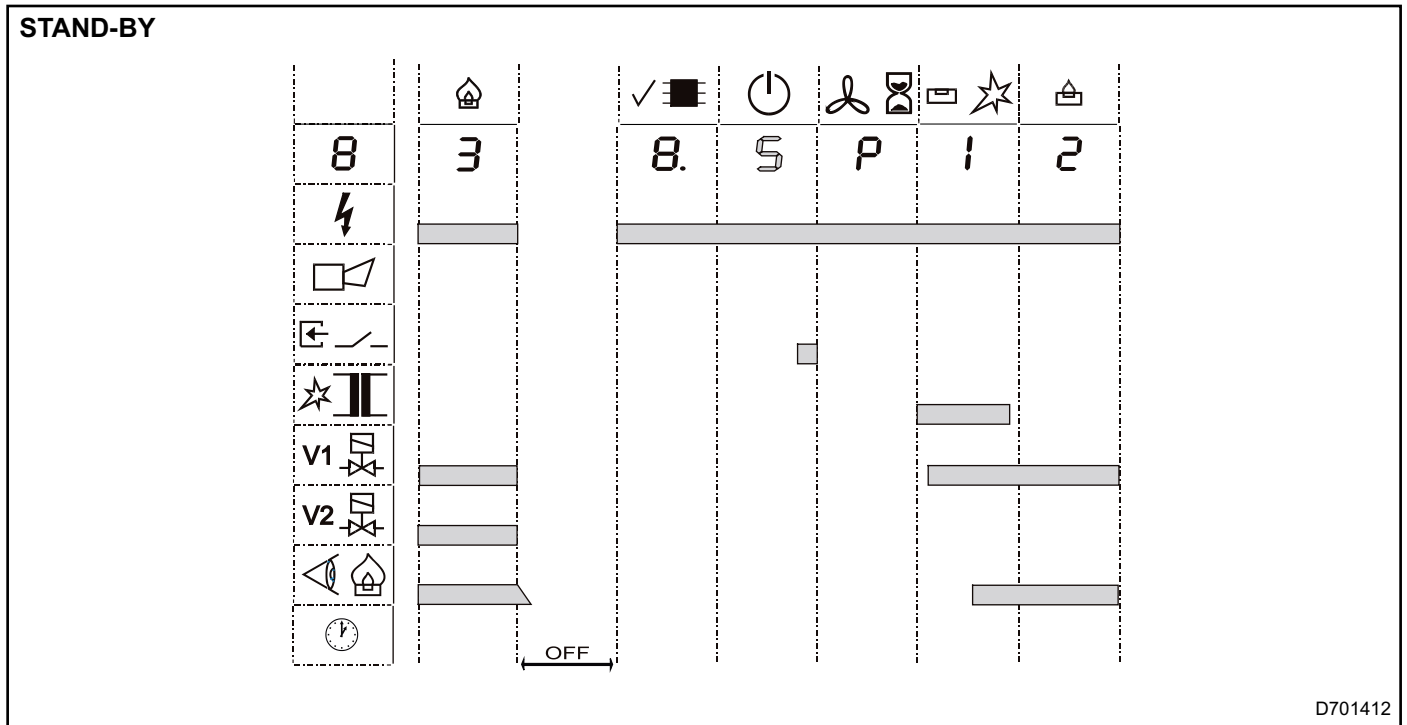

ILLEGAL FLAME PRESENCE

The scheme describes the ESA ESTRO actions in case of illegal flame signal before burner ignition or after shut-off.

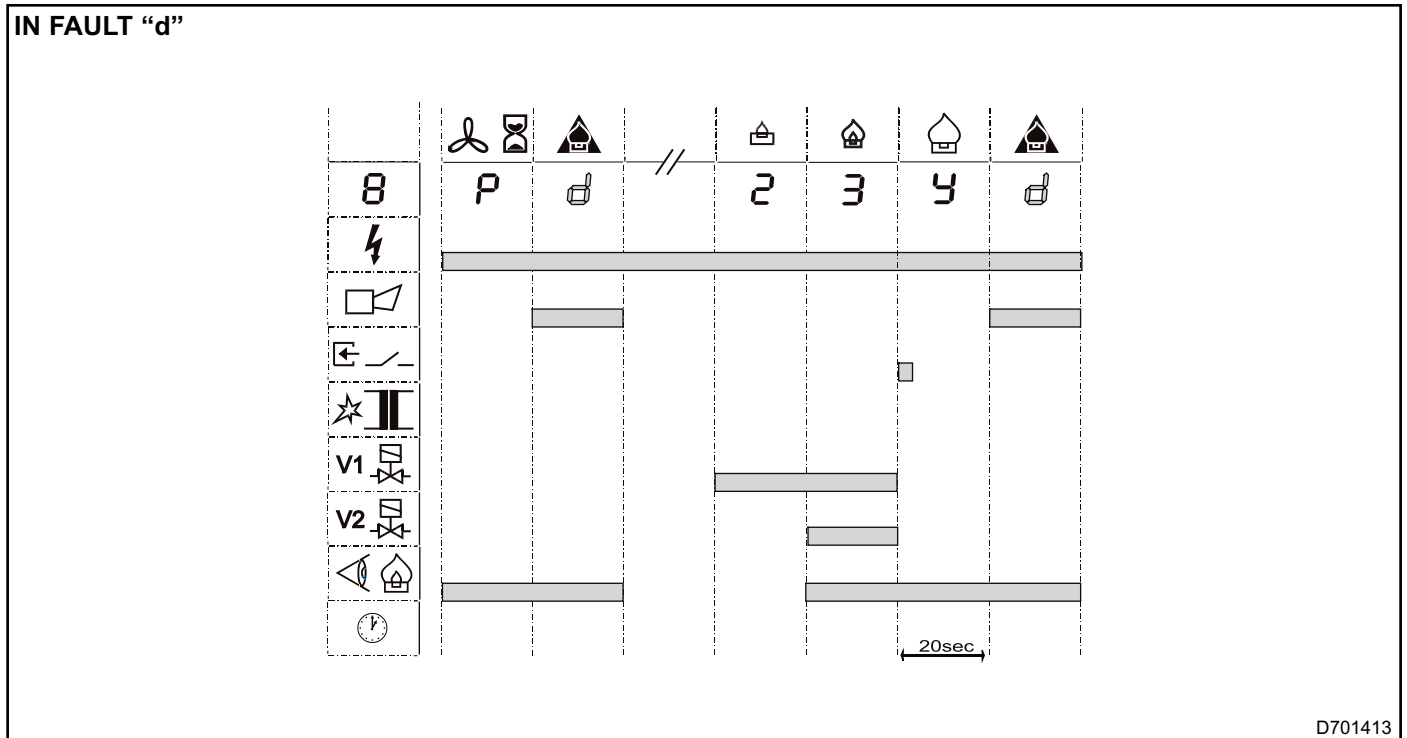

FAILED IGNITION

The scheme describes the actions in case of failed ignition attempt at 1st gas stage.

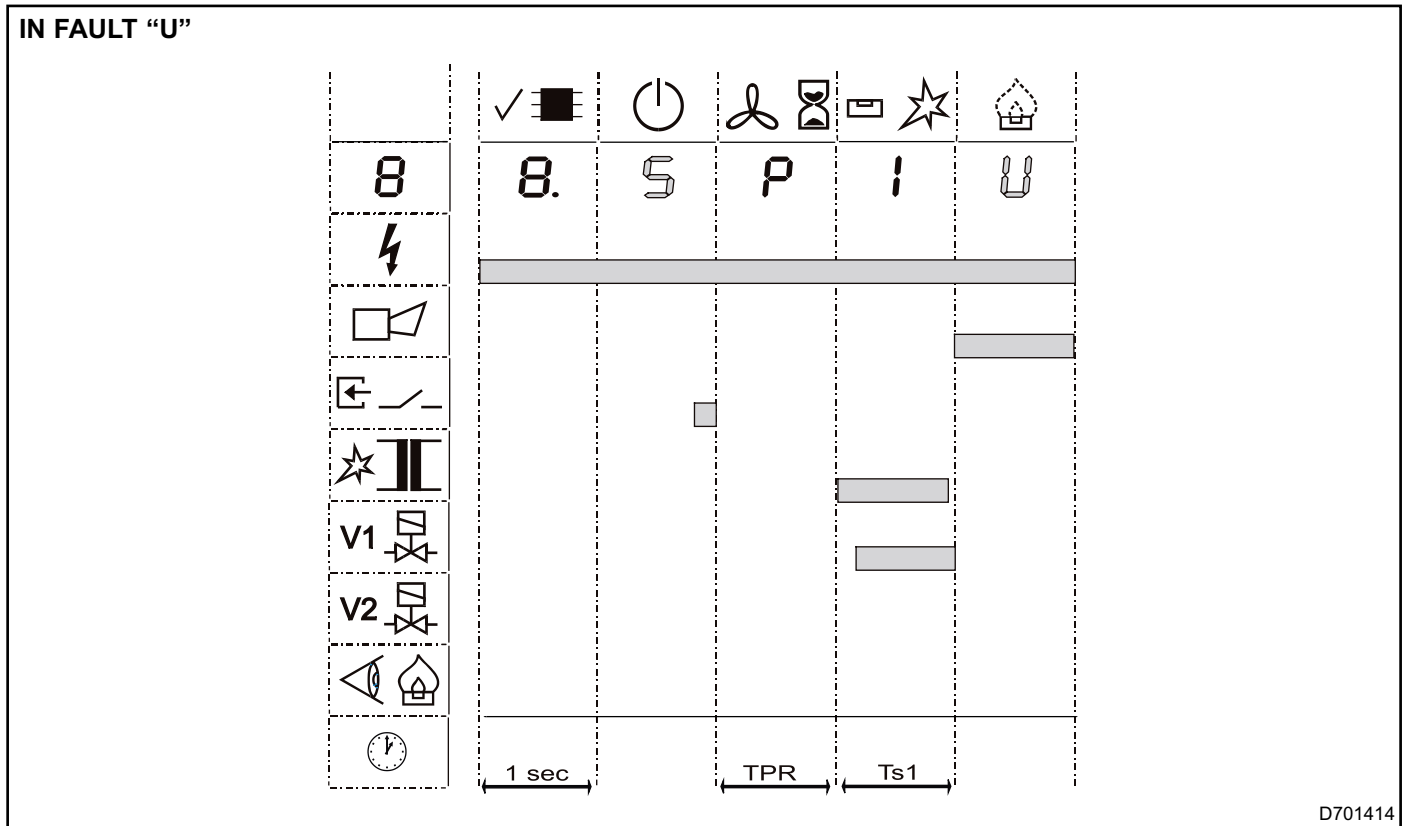

FLAME SIGNAL LOST

The scheme describes the actions in case of flame signal loss during the normal operation stage and in case of setting of the parameter "Flame loss" as "Lockout".

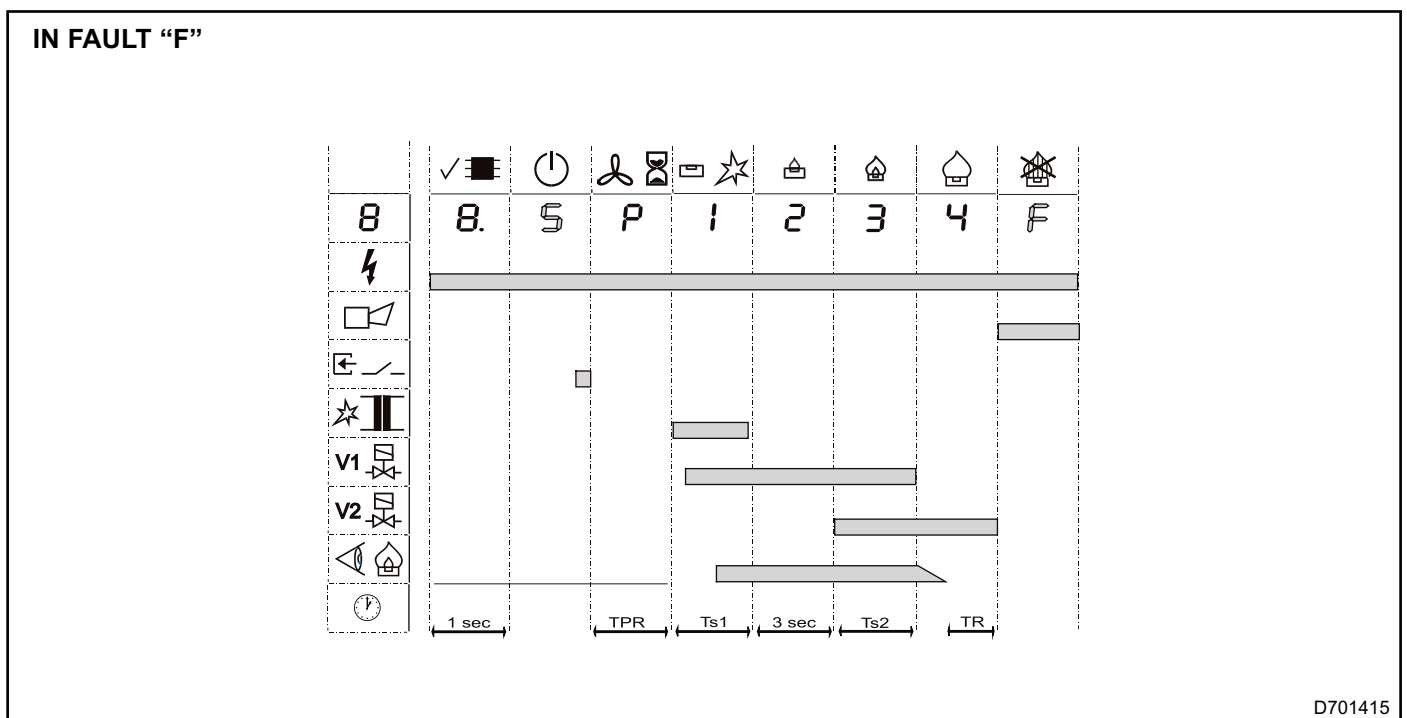

CONFIGURATION: SETTING PARAMETERS

The configuration defines the operation mode of ESA ESTRO according to the combustion plant needs.

In compliance with the reference norm, some of the parameters are set and locked at the device's production facility, while others can be modified by the user with dedicated tools.

The variation of setting parameters can be done only if ESA ESTRO is in "manual stop" phase and can be done via a portable programming device (infrared) to modify the serial communication parameters (i.e. device IP

address) or through a specific software via serial communication interface (ECS driver) to modify every unlocked parameter.

The programming software, moreover, allows the user to lock some additional setting parameters if needed, for safety reasons.

The configuration via ECS serial interface is allowed only for one device at a time and it is necessary to disconnect the device from the field network as well as the direct connection to the programming PC card interface.

Unlocked setting parameters

PARAMETER	VALUE	DESCRIPTION
Address Segment	0 ÷ 9 and A ÷ Z capital	"Address Node" identifies the device for serial communication. Adopting ECS protocol defines the zone or belonging group. Adopting Modbus-RTU defines the first char of the address (0÷F per 0÷16).
Address Node	0 ÷ 9 and A ÷ Z capital	"Address Segment" identifies the device for serial communication. Adopting ECS protocol defines the device unity inside a zone or belonging group. Adopting Modbus-RTU defines the second char of the address (0÷9).
Baudrate Protocol	4800 ÷ 38400 ECS	Communication speed with ECS protocol (4800, 9600, 19200 and 38400 Bit/s).
	4800 ÷ 38400 ModbusRTU 1	Communication speed (4800, 9600, 19200 e 38400 Bit/s) with Modbus RTU protocol (1 stop bit).
	4800 ÷ 38400 ModbusRTU 2	Communication speed with Modbus RTU protocol (4800, 9600, 19200 and 38400 Bit/s).
Communication timeout	0 ÷ 480	Time limit for serial communication signal absence, set in ten steps from 0 to 480 sec., the device signals a "Com-timeout" alarm in case this time is exceeded. Setting at "0" sec. this parameter deactivates the com-timeout alarm when the serial communication is not adopted.
Prepurge time	0 ÷ 255	Time of furnace chamber purging or waiting before burner ignition. In case of applications with air valve control, the countdown starts when the position switch signals the maximum valve opening.
Regulation delay time - 2°safety time	0 ÷ 25	Waiting time after the flame stability check at 1st stage; Once this phase has been concluded the air valve opening is allowed (for ESTRO-A and expansions). For ESA ESTRO-B this period refers to the second safety time (ignition 2°gas stage), therefore the setting parameter is locked. Moreover once this time lapse has passed the 1st stage is turned off in case of discontinuous setting.
Postpurge time	0 ÷ 255	Time of furnace chamber purging after shut-off or waiting before next burner ignition (air valve opening in case of applications with air valve control). During this phase the device doesn't accept any external commands. The function "Post purge flex" defines the minimum interval of time between two ignition attempts.

PARAMETER	VALUE	DESCRIPTION
Cycle start	Autostart	The ignition cycle starts automatically at power supply (except for cases of burner lockout before shut-off). This type of setting is suitable for burner control via the power supply device.
	Standby	The ignition cycle doesn't start automatically at power supply (waiting for local or remote command). This type of setting is suitable for burner control via the serial communication.
Daily shut off	Inhibited	The device doesn't turn OFF automatically every 24 hours for self-diagnosis. This selection is allowed only for combustion plants with several burners installed in the same furnace chamber, nevertheless the accomplishment of the self-diagnosis shut-off has to be controlled by the overall control system. If this function is activated, the device only complies to EN746-2.
	Enable	The device turns OFF automatically every 24 hours for self-diagnosis and flame detection probe test.
Air pressure switch	Inhibited	The air pressure switch connected to the expansion card is not verified.
	Waiting	A missing signal from the air pressure switch implies: - during the purging phase it sets the countdown to zero; -(with continuous air control) burner shut-off waiting the new signal presence (automatic restart). -(with discontinuous or pulse air control, and burner lights the status will change for deactivation of air)
	Lockout	A missing signal from the air pressure switch implies: - during the purging phase it sets the countdown to zero; - (with continuous air control) burner shut-off waiting the new signal presence (reset requested for restart). - (with discontinuous or pulse air control, and burner lights the status will change for deactivation of air)
Thermostat	Inhibited	The thermostat connected to the expansion card is not verified.
	Enable	The device waits for the thermostat signal presence before burner ignition; in case of signal absence the burner is turned OFF until a new signal is present, restart automatically.
Air damper	Inhibited	The air valve position (through the aux. switches) is not verified for purging and ignition.
	Local	The device controls the air valve position: it opens the valve up to the maximum opening (max. position switch signal) to start the purging time countdown; then it closes the valve (min. position switch signal) in order to allow the burner ignition.
	Remote	A remote supervisor controls the air valve position: it opens the valve up to the maximum opening (max. position switch signal) to start the purging time countdown; then it closes the valve (min. position switch signal) in order to allow the burner ignition.

PARAMETER	VALUE	DESCRIPTION
EXP Installed	Inhibited	The device doesn't control any expansion cards (this setting is required in case EXP-2 and EXP-4 are not installed).
	Enable	The device controls the installed expansion cards (this setting is required in case EXP-2 and EXP-4 are installed).
Behaviour at flame loss	Lockout	In case the signal of flame presence is missing for a period exceeding the "Reaction time" the burner is turned OFF (reset required for restart).
	Recycle	In case the signal of flame presence is missing the device generates a new ignition cycle (including purging). In case of proper ignition, at the next signal of missing flame presence the device repeats the ignition cycle.
	Respark	In case the signal of flame presence is missing the device generates a new ignition cycle (excluding purging). In case of proper ignition, at the next signal of missing flame presence the device repeats the ignition cycle.
	Only one recycle	In case the signal of flame presence is missing the device generates a new ignition cycle (including purging). In case of proper ignition, at the next signal of missing flame presence the device turns OFF the burner (reset required for restart).
	Only one respark	In case the signal of flame presence is missing the device executes a new ignition cycle (excluded purging). In case of proper ignition, at the next signal of missing flame presence the device turns OFF the burner (reset required for restart).
Digital input function	Inhibited	The digital input of the device is not checked.
	Reset / Stop	The digital input plays a double role: it leads to the manual burner shut-off in case the burner was ON or the burner restarts (if activated for a time between 1 and 3 sec.) in case the burner was in the lockout stage.
	Only stop	The digital input of the device is verified only with burner ON: when activated leads the manual burner shutoff.
	Only reset	The digital input of the device is verified only with burner in lockout stage: if activated for a time between 1 and 3 sec it restarts the burner.
	Thermostat	The digital input has the thermostat function as the digital input foreseen in the expansion card EXP-2: when the input is active, the device ignites the burner, whilst when the input is deactivated it determines the burner shut-off. This setting is allowed only in case the expansion card EXP-2 is not installed.
	High temperature	The digital input is used to activate the specific operation. This setting is allowed only in compliance with EN746-2 and the activation of this function is correlated to the "High temperature function" parameter .
	Main burner on / off	The digital input controls the 2nd gas stage as an alternative to the serial commands: with active input and 1st stage gas ON, the device allows the ignition of the 2nd stage gas; while with input deactivated it leads to the burner shut-off.
Air valve on / off	The digital input controls the air valve as an alternative to the serial commands: with active input and 1st stage gas ON, the device allows air valve opening; while with input deactivated it leads to the valve closure. This function can be activated only when the air control is discontinuous.	

PARAMETER	VALUE	DESCRIPTION
Lockout output	Stop / fault	The device activates the output signal in case of lockout, manual shut-off or waiting for power supply (blinking display). The output is deactivated during the self-diagnosis phase.
	Fault	The device activates the output signal only in case of lockout. The output is deactivated during the self-diagnosis phase, the manual shut-off or waiting for power supply.
Local button	Remote enable	The device doesn't verify the push button because its control is accomplished through serial communication. When the specific command of request status is received, the device activates the button with "Reset / Stop" function in order to allow the operation of maintenance with local control.
	Reset / stop	The push button plays a double role: if the burner is ON, it leads to the immediate shut-off, in case the burner is in lockout phase or is turned OFF, if pressed for a period between 1 and 3 sec it restarts the burner.
	Only stop	The device verifies the push button only in case of burner ON: when pressed it leads to the immediate burner shutoff.
	Only reset	The device verifies the push button only in case the burner is in lockout phase or is turned OFF: if pressed for a time between 1 and 3 sec it restarts the burner.
Air flow control type	Continue	The device activates the air valve (or blower) from the initial start command until the burner shut-off (requested or lockout). If this configuration is present, the commands "Air on" and "Air off" are ineffective.
	Discontinue	The device activates the air valve (or blower) from the initial start command until the end of the purging phase, then the valve is deactivated during the ignition stage and it again activated again after the "Regulation delay time" until the burner shut-off (requested or lockout). If this configuration is present, the commands "Air on" and "Air off" are effective only after the "Regulation delay time".
	Pulse	The air valve is activated after the "Regulation delay time" until the burner shut-off (requested or lockout). If this configuration is present, the commands "Air on" and "Air off" are effective for air valve control.
	Remote	The device activates the air valve (or blower) from the initial start command until the end of the "Regulation delay time". This type of configuration can be adopted with the expansion card EXP-2.
Postpurge flex	Inhibited	The device starts the "Post purge time" countdown from the burner shut-off or lockout.
	Enable	The device starts the "Post purge time" countdown from the burner ignition. The "Post purge flex" function defines the minimum interval of time between two ignition attempts.

Locked Setting Parameters

PARAMETER	VALUE	DESCRIPTION
1° safety time	1 ÷ 25	First safety time for 1st gas stage ignition (see tables for admitted values).
Reaction time	1 ÷ 20	Maximum safety time between the flame extinguishment and the gas valve interception (see tables for admitted values). In case the flame presence signal is generated again before the Reaction time ends, the device keeps the current phase; otherwise it defines the action as per the "Behavior at flame loss" parameter.
1° stage gas outlet type	Intermittent	The 1st stage gas remains ON also during the 2nd stage gas until the simultaneous shut-off of both valves. This setting is allowed only for ESTRO-B version.
	Interrupted	The 1st stage gas is turned OFF during the 2nd stage gas when the second safety time or "Regulation delay time" (2nd stage stabilization) is exceeded. This setting is allowed only for ESTRO-B version.
High temperature function	Inhibited	The High Temperature Function is never enabled, even in case of specific digital input signal.
	Enable	The High Temperature Function is enabled while a specific digital input signal is present. In this phase the gas interception valves remain open even in case of missing signal of flame presence. In case this function is enabled, the device only complies to EN746-2.
1°stage gas ignition type	Fixed	The period of 1st gas stage ignition is fixed. The device verifies the flame formation only after the 1st safety time and after the ignition transformer deactivation. This configuration is mandatory for unirod or UV-scan flame detection systems.
	Variable	The period of 1st gas stage ignition can be reduced. The device continuously verifies the flame formation and deactivates the ignition transformer as soon as the flame is stabilized. This configuration can be applied in case of flame detection systems with dedicated electrode.
Automatic reset	0 ÷ 9	Maximum number of automatic resets accomplished automatically by the flame supervisor without generation of a remote signal for burner's lockout. By setting to 0 this parameter, the function is deactivated. In case this function is enabled, the device only complies to EN746-2.

The following table shows the maximum safety and reaction times allowed. Refer to the specific norm in order to define the proper parameters related to each industrial application, adopting values that do not compromise the

process safety. In case the setting parameters are not in compliance with EN298 but only with EN746-2, the ESTRO identification plate reports only this norm.

APPLICATION	NORM	SAFETY TIME	REACTION TIME	REMARKS
GAS BURNERS	EN298	-	Max. 1 s	Restart and Respark allowed.
	EN676	According the application max. 5 s	Max. 1 s	According to the application, only 1 Restart allowed. "Pre purge" mode as claimed
	EN746-2	According the application Max. 10 s	According the application Max. 2 s	According to the application, one Restart attempt in case of flame missing signal, two automatic unlocks and high temperature operation are allowed. "Pre purge" mode as claimed
OIL BURNERS	EN230	According the application Max. 20 s	Max. 1 s	According to the application Restart and Respark allowed. "Pre purge" mode as claimed
	EN746-2	According the application Max. 10 s	According the application Max. 2 s	According to the application, one Restart attempt in case of flame missing signal, two automatic unlocks and high temperature operation are allowed. "Pre purge" mode as claimed

INSTALLATION

Respect the following instructions for a correct installation.

1 - Avoid placing the equipment near intense magnetic or electric fields, and in conditions of direct exposure to heat or products resulting from combustion, such as corrosive liquids, solvents or gases.

2 - The equipment must be installed by technically qualified staff, in compliance with the regulations in force at the time and in the place of installation.

3 - A minimum protection class of IP40 must be always guaranteed for the device case during the installation operation. For devices applied in open environments a protection class of IP54 must be always guaranteed. The protection class (i.e. IP54) can be guaranteed also from the instrument where the device is installed (i.e. furnace's electrical control panel).

4 - With phase-phase power supply system, an insulation transformer with a terminal of secondary coil put to earth must be applied.

5 - When carrying out the electrical connection, refer to the technical documentation, observing the polarity between the phase and neutral. The terminals for the electric connection are of the screw type and can accept conductors with a cross section of 0.5 to 2.5mm²; the choice of the conductors and the positioning must be suitable for the application.

6 - The connection cable between the ignition transformer and the rod on the burner must be specific for high voltage applications and not the shielded type. The HV (High Voltage) length must be less than the size indicated; otherwise the ignition transformer must be located near the burner. The HV cable must be laid far from the power supply cables and not in metallic ducts, ideally the cable should be left in open air.

7 - The flame detection cables must be laid separately from the other conductors and therefore the use of multi-pair cables is not permitted, nor is the use of shielded cables.

8 - The detection probes and any connectors must be insulated and made inaccessible by using suitable guards, thereby allowing access only to authorized staff; if needed, warnings should be placed near the probes.

9 - Always make sure that the earth protection is connected to the appropriate terminals and to all the metal casings of the elements connected with suitable conductors. Use the available screw placed in the base of the device, for earth wiring.

10 - When using the digital input, connect the RC filter, while the cables entering the expansion cards must be rolled up at least once around the ferrite supplied.

11 - In multiple-burner applications, the parallel connections of the outputs of several devices are not allowed. If the system is equipped with a serial interface connection, please adhere to the special instructions provided for using the remote-controlled functions.

12 - The communication line must be separated from the supply line, motor control (inverters) and network voltage. NEITHER MULTIPAIR NOR SHIELDED cables must be used.

13 - Use the specific ECS CABLE for communication lines; as an alternative, we recommend using the bus-bar system, bearing in mind that a cable of a max. length of 1 m must be used between the bus-bar and the instrument for both communication and power supply lines.

14 - The input cables for the optional EXP-2 card must be wrapped at least once around the ferrite provided.

WARNINGS

Respect the following instructions for a correct use of the device.

■ ESA ESTRO is intended for permanent connection to the electric installation. Inversion of the phase/neutral connection could compromise the safety of the system. Never use different phases between the voltage inputs and do not apply voltage signals into output or serial communication terminals.

■ Check that it is connected correctly after installation. Before powering the device, ensure that the voltage and frequency is correct, and check that the loads do not have greater absorption than the maximum capacity of the output contacts.

■ The thermostat inputs (digital input or on expansion) are not safety inputs, but only command the burner start and stop for temperature regulation. Disconnect the power supply to obtain a safety shut-down. The same advice is valid for the devices controlled by serial communication.

■ When the function of digital input is Reset/Stop, Only Reset or Only Stop, the digital input command must be a pulse and must not be present during the device diagnosis (after power on, etc). In case the function of digital input is Thermostat, Main On/Off or Air On/Off, the command must be continuous and can be maintained during the device diagnosis.

■ The solenoid gas valve power supply must be taken only by the specific output of the ESA ESTRO.

■ The control of solenoid gas valves by other devices (relay, PLC) that receive the signal by the ESA ESTRO is not permitted.

■ In case of noises during the ignition phase, due to the presence of other electrical equipment, it is mandatory to adopt a plug connector provided with filter against noises for the ignition electrode.

■ In case of single electrode ignition/detection it is necessary to adopt ignition transformers specifically designed for this purpose.

■ In order to avoid the overheating of the electrical control devices (solenoid valves and transformers) it is requested to keep a minimum time lapse between the ignition attempts. The minimum time should be calculated as follows: the sum of the purging time + the first safety time + 5 additional sec.

■ The choice of the setting parameters has to be made in compliance with the specific reference norms, but also with the aim of avoiding potential risks related to particular operating conditions of the combustion unit.

■ Disconnect power supply before accomplishing any kind of operation on the device. Number each connector before disconnecting the device.

■ In case of malfunctioning ESA ESTRO must be sent back to the manufacturer for inspection and maintenance. The warranty of the device automatically expires if any type of repair or alteration is realized by unauthorized technicians, due to the fact that the safety of the device has been compromised.

■ ESA ESTRO is a device developed to supervise burner safety. It cannot be adopted as a system for burner regulation: this type of control has to be done using proper instruments.

ESA ESTRO-A CONNECTIONS

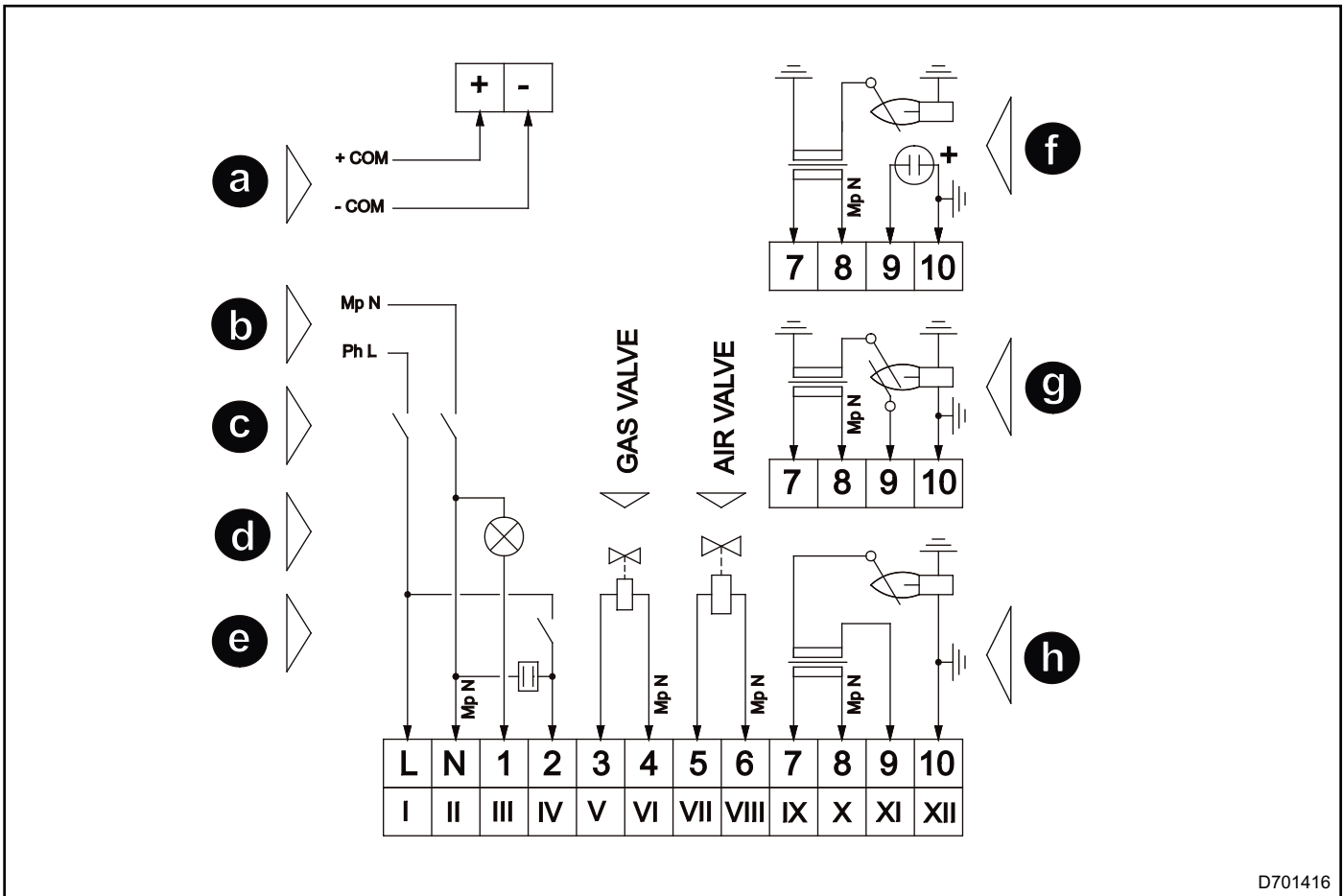

D701416

Pos.	Description	Pos.	Description
a	ECS serial communication	e	Digital input
b	Power	f	Detection flame with UV phototube
c	Safety stop	g	Detection flame with rod
d	Lockout alarm output	h	Detection flame with unirod

Connector terminals

Pos.	Description	Pos.	Description
L	Power supply phase	6	Air valve neutral
N	Power supply neutral	7	Ignition transformer phase
1	Lockout signal output (phase)	8	Ignition transformer neutral
2	Digital input (phase)	9	Detection rod, signal from transformer (uni-rod) or UV phototube negative terminal
3	1st stage gas valve phase	10	Protection ground, UV phototube positive terminal and burner case
4	1st stage gas valve neutral	+	Positive input for serial communication
5	Air valve phase	-	Negative input for serial communication

ESA ESTRO-B CONNECTIONS

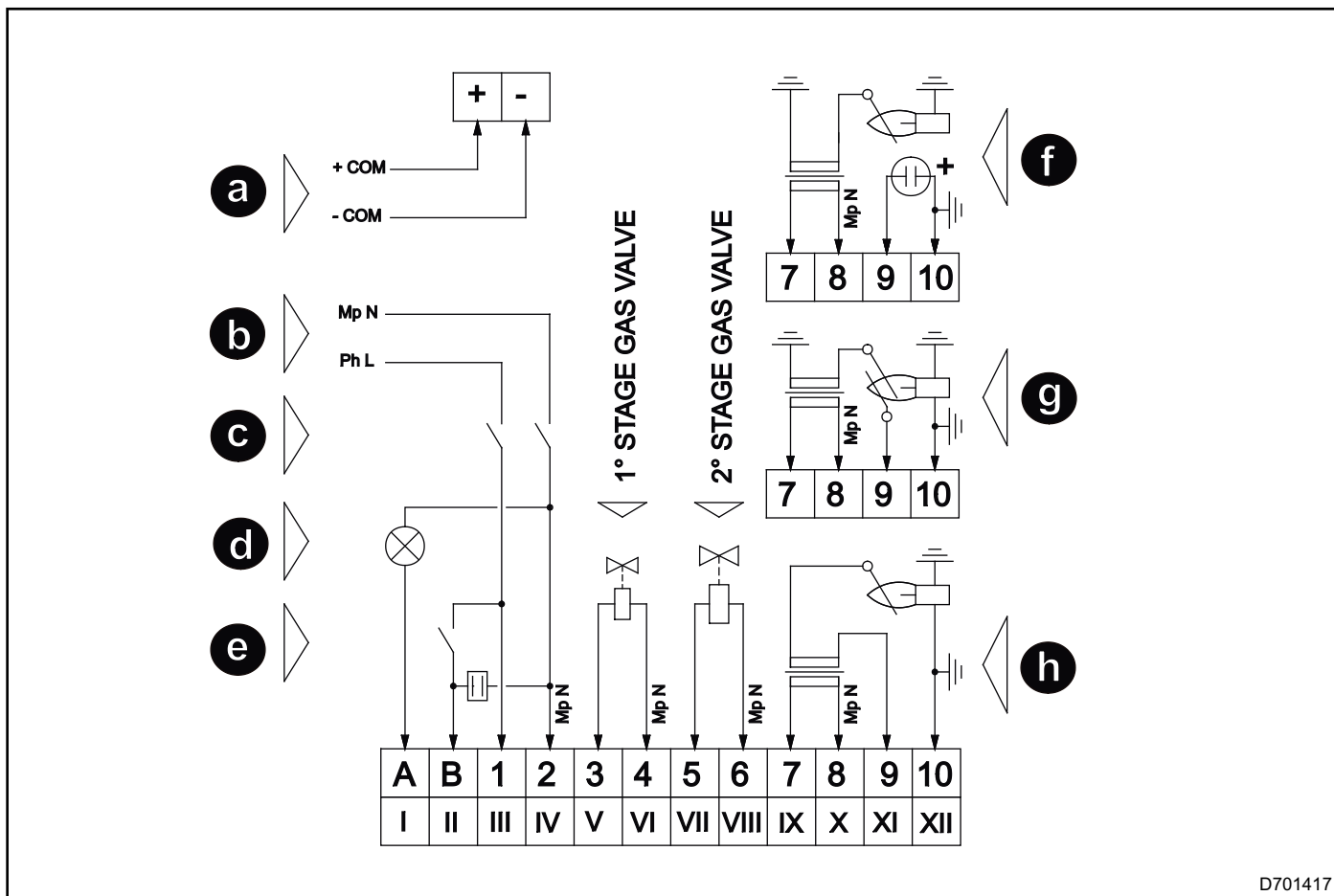

D701417

Pos.	Description	Pos.	Description
a	ECS serial communication	e	Digital input
b	Power	f	Flame detection with UV phototube
c	Safety stop	g	Flame detection with rod
d	Lockout alarm output	h	Flame detection with unirod

Connector terminals

Pos.	Description	Pos.	Description
A	Lockout signal output (phase)	6	2nd stage gas valve neutral
B	Digital input (phase)	7	Ignition transformer phase
1	Power supply phase	8	Ignition transformer neutral
2	Power supply neutral	9	Detection rod, signal from transformer (uni-rod) or UV phototube negative terminal
3	1st stage gas valve phase	10	Protection ground, UV phototube positive terminal and burner case
4	1st stage gas valve neutral	+	Positive input for serial communication
5	2nd stage gas valve phase	-	Negative input for serial communication

ESA ESTRO-C CONNECTIONS

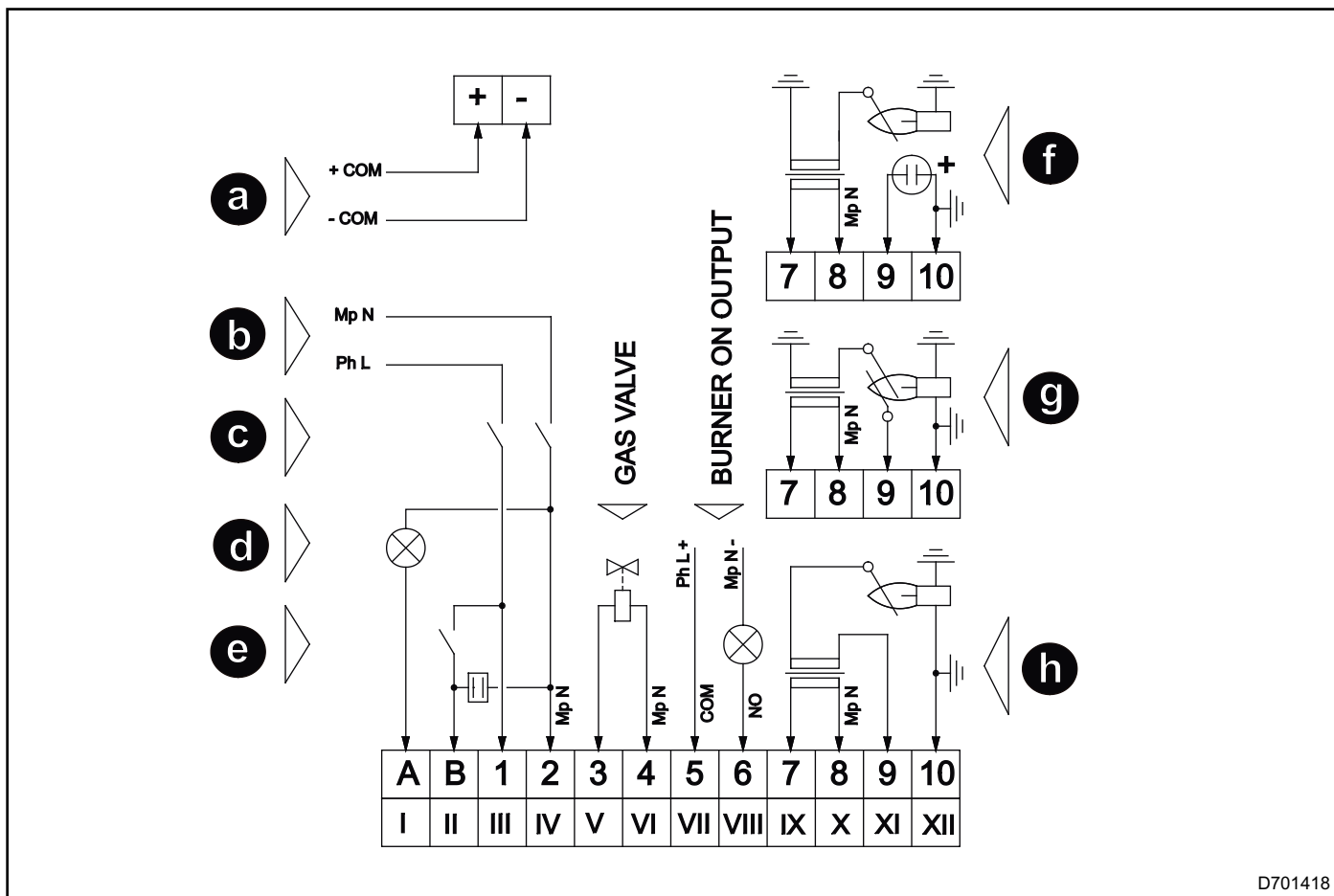

D701418

Pos.	Description	Pos.	Description
a	ECS serial communication	e	Digital input
b	Power	f	Flame detection with UV phototube
c	Safety stop	g	Flame detection with rod
d	Lockout alarm output	h	Flame detection with unirod

Connector terminals

Pos.	Description	Pos.	Description
A	Lockout signal output (phase)	6	Burner ON free contact output (NO)
B	Digital input (phase)	7	Ignition transformer phase
1	Power supply phase	8	Ignition transformer neutral
2	Power supply neutral	9	Detection rod, signal from transformer (unirod) or UV phototube negative terminal
3	1st stage gas valve phase	10	Protection ground, UV phototube positive terminal and burner case
4	1st stage gas valve neutral	+	Positive input for serial communication
5	Burner ON free contact output (Com)	-	Negative input for serial communication

ESA ESTRO-Q CONNECTIONS

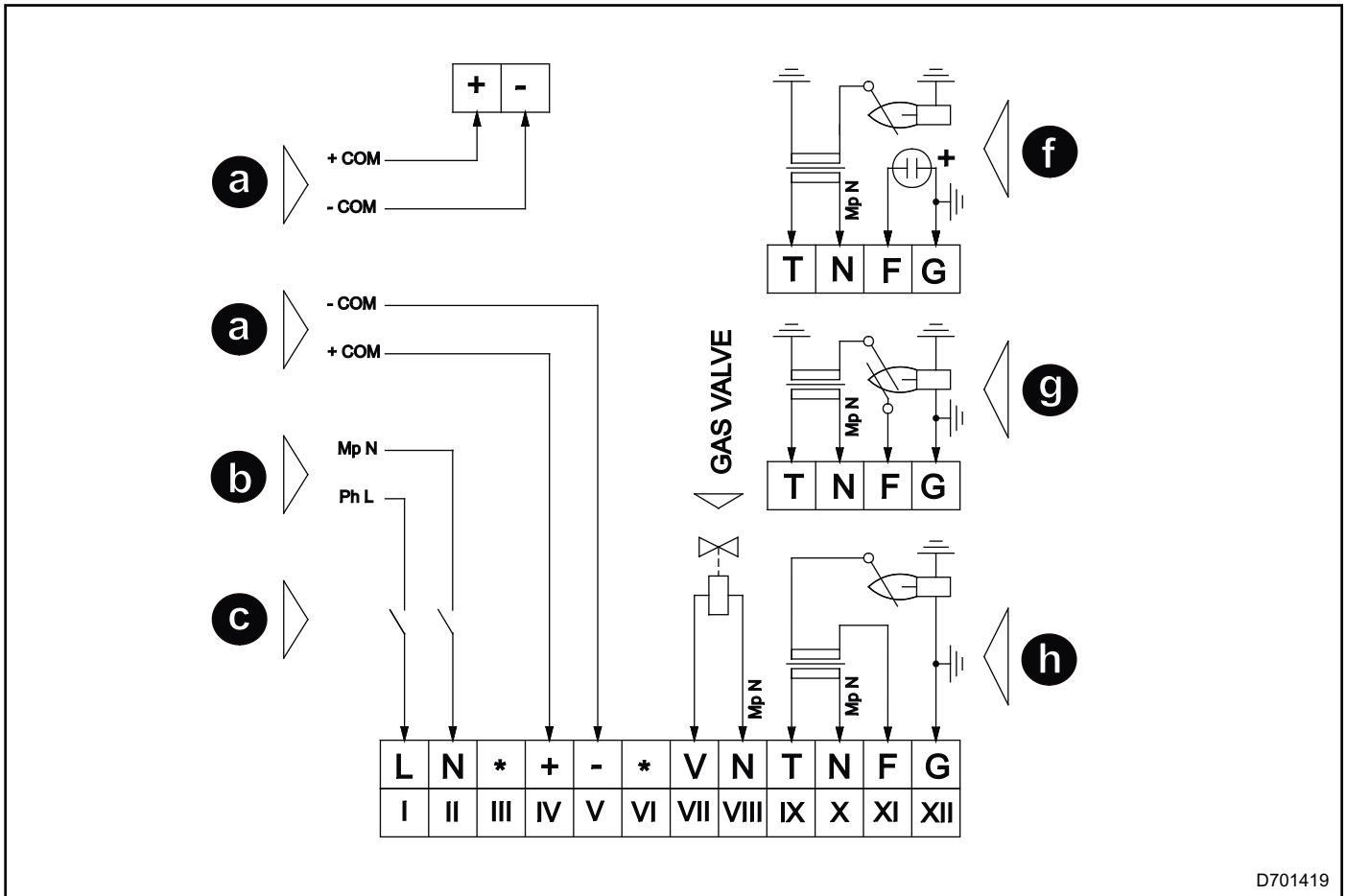

D701419

Pos.	Description	Pos.	Description
a	ECS serial communication	f	Flame detection with UV phototube
b	Power	g	Flame detection with rod
c	Safety stop	h	Flame detection with unirod

Connector terminals

Pos.	Description	Pos.	Description
L	Power supply phase	N	1st stage gas valve neutral
N	Power supply neutral	T	Ignition transformer phase
*	Not connected	N	Ignition transformer neutral
+	Positive input for serial communication	F	Detection rod, signal from transformer (unirod) or UV phototube negative terminal
-	Negative input for serial communication	G	Protection ground, UV phototube positive terminal and burner case
*	Not connected	+	Positive input for serial communication
V	1st stage gas valve phase	-	Negative input for serial communication

ESA-EXP 2 CONNECTIONS

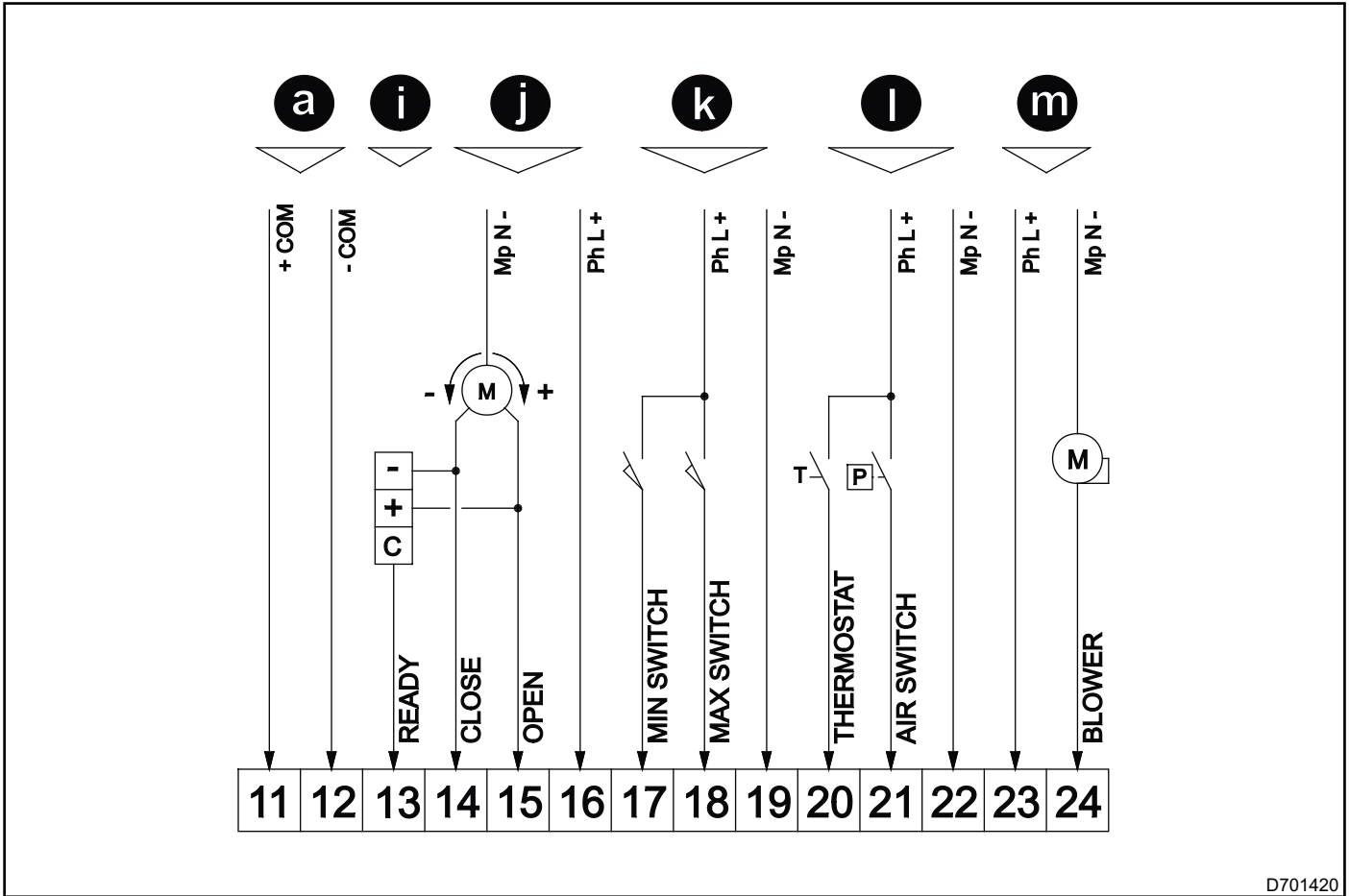

D701420

Pos.	Description	Pos.	Description
a	ECS serial communication	k	Air damper position switch
i	Temperature regulator	l	Process input
j	Air damper motor	m	Air valve or combustion blower

Connector terminals

Pos.	Description	Pos.	Description
11	Positive input for serial communication	18	Air damper hi-fire switch input (phase)
12	Negative input for serial communication	19	Air damper limit switch inputs common (neutral)
13	Temperature regulation enabling output (phase)	20	Thermostat start/stop input (phase)
14	Air damper closing output (phase)	21	Air pressure switch input (phase)
15	Air damper opening output (phase)	22	Process limits inputs common (neutral)
16	Air damper motor power supply (phase)	23	Input power supply for air valve or combustion blower (phase)
17	Air damper lo-fire switch input (phase)	24	Output power supply for air valve or combustion blower (phase)

SIZES

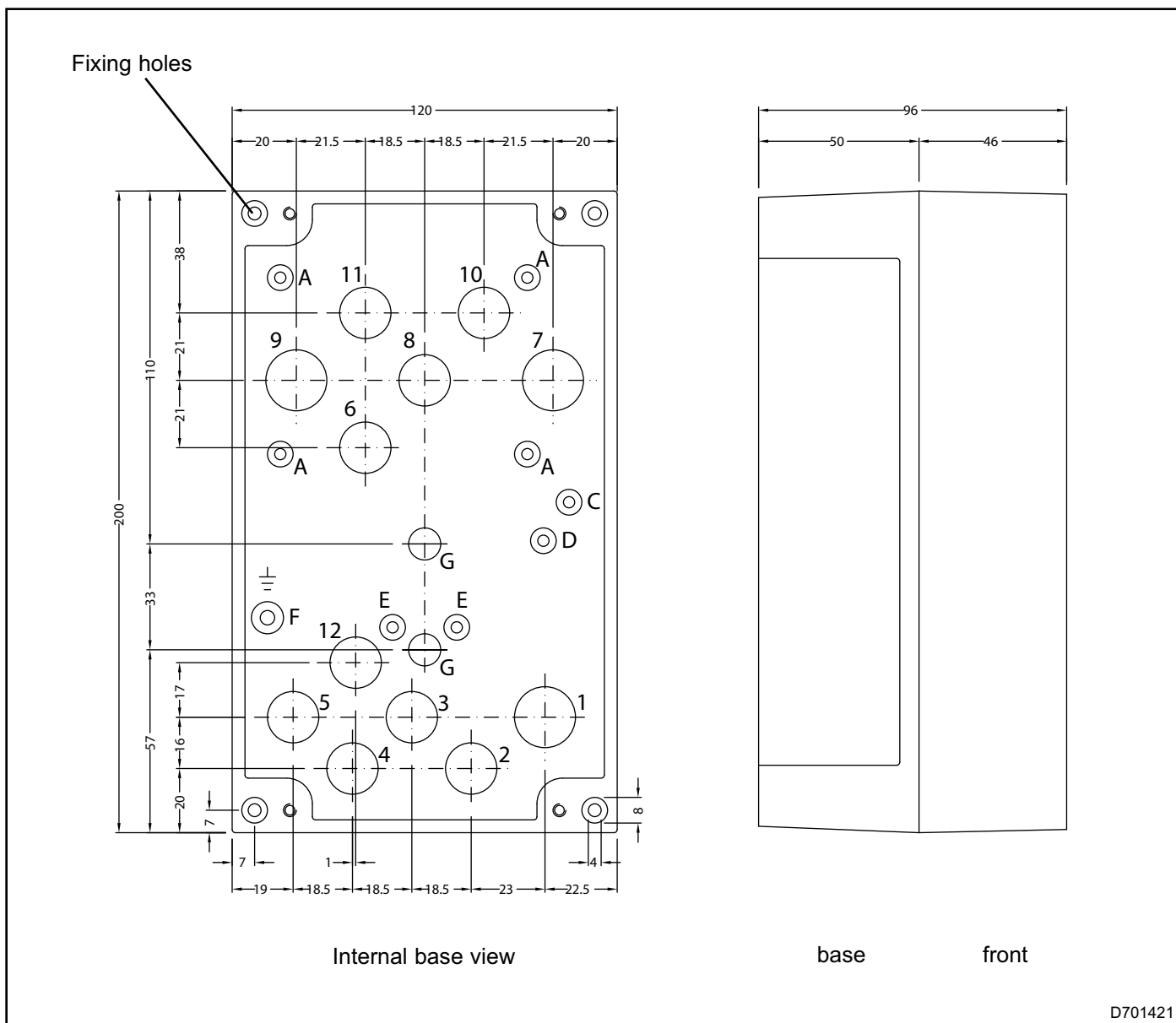

PREFORMED HOLES	DIAMETER MM	CONNECTOR
1	19	PG11 - M20x1
2-3-4-5-12	16	PG9 - M16x1
6-8-10-11 *	16	PG9 - M16x1
7-9 *	19	PG11 - M20x1

POS.	DESCRIPTION
A	Fastening connections for transformer
C	Available (Not used)
D	Available (Not used)
E - E	Available (Not used)
F	Terminal earthing
G - G	Fixing holes for collar fixed back (tube 1/2") - screw M6

* When transformer is present, it is not possible to use preformed holes No. 6÷11

When EXP-2 expansion card is present, it is not possible to assemble ignition transformer inside ESA ESTRO; in this case, use ESA TRAF0 box (see technical sheet E5004).

ORDERING CODE

ESTRO	01	02	03	04	05	06	07	08	09	10	11	12	13	14	15	16
	17	18	19	20	21	22	23	24	25	26	27	28	29			

01 VERSION		01	11 DAILY CHECK SHUT OFF		19	REACTION TIME	
ESTRO - A	A2		Enable (test every 24h)	D	From 1 to 9 seconds	1 - 9	
ESTRO - B	B2		Inhibited	/	From 10 to 20 seconds	A - K	
ESTRO - C	C2						
ESTRO - Q	Q2						
02 CYCLE START		02	12 AIR FLOW CONTROL MODE		20	COMMUNICATION TIMEOUT	
Automatic ignition (autostart)	A		Continue or not present	C	0 seconds	0	
Wait for manual reset (standby)	S		Discontinue	D	8 seconds	1	
			Pulse	P	16 seconds	2	
			Remote	R	32 seconds	3	
					64 seconds	4	
					128 seconds	5	
					256 seconds	6	
					320 seconds	7	
					400 seconds	8	
					480 seconds	9	
03 PREPURGE		03	13 DIGITAL INPUT FUNCTION		21	COMMUNICATION BAUDRATE	
from 0 to 99 seconds	(**)		Inhibited	/	4800	4	
2 minute	2M		Reset/stop	B	9600	9	
3 minute	3M		Only stop	S	19200	1	
4 minute	4M		Only reset	U	38400	3	
			Thermostat	T			
			High temperature enabling	H			
			Main ON/OFF function	M			
			Air ON/OFF function	A			
04 1 ST SAFETY TIME		04	14 LOCK OUTPUT		22	COMMUNICATION PROTOCOL	
from 0 to 25 seconds	(**)		Active only with lockout	F	ECS	E	
			Active with lockout and stop	B	MODBUS 1	1	
					MODBUS 2	2	
05 REGULATION DELAY TIME		05	15 LOCAL BUTTON		23	SPARE	
from 0 to 25 seconds	(**)		Stop/reset	B		/	
			Stop/reset enabled from remote	R			
			Only stop	S			
			Only reset	U			
06 1 ST STAGE GAS OUTLET TYPE		06	16 AUTOMATIC RESET		24	SPARE	
Intermittent (continuous)	C		Reset number	0-9		/	
Interrupted	D						
07 BEHAVIOR AT FLAME LOSS		07	17 HIGH TEMPERATURE FUNCTION		25	SPECIAL VERSION	
Lock-out stop	N		Inhibited	/	Standard	/	
Cycle repetition enabled	Y		Enable	H	Ignition transformer inside	T	
Re-ignition enabled	K				Pre wiring	C	
Only one cycle repetiton	R				ESA TRAF0 coupled box	A	
Only one re-ignition	S				With expansion EXP-2	2	
					With expansion EXP-3	3	
					With expansion EXP-4	4	
08 SUPPLY VOLTAGE		08	18 1 ST STAGE GAS IGNITION TYPE		26	EXPANSION PARAMETERS	
115 Vac	1		Fixed safety time	/	27	No expansion	////
230 Vac	2		Variable safety time	S	28	EXP-2	see. tab. A
					29	EXP-3	see.E7015
						EXP-4	see.E7016
09 POSTPURGE FLEX		09					
Inhibited	/						
Enable	F						
10 POSTPURGE TIME		10					
From 0 to 99 seconds	(**)						
2 minute	2M						
3 minute	3M						
4 minute	4M						

26	Supply voltage	27	Air pressure switch	28	Thermostat input	29	Air damper input
115 Vac	1	Inhibited	/	Inhibited	/	Inhibited	/
230 Vac	2	Puts in waiting phase	H	Enable	T	Remote serial control	R
24 Vac	4	Stop in lock-out status	L			Local digital control	L

(**): insert value (in seconds)

(Parameter 25) Some selections are not compatible with each other (see "Size"), if there are more possible selections (T e C, 2 e C o A, etc) the code priority must be as follows: expansion card, cabling, ignition transformer and finally the coupled ESA TRAF0.

