

Logic Processing

*Modular sequencer, inline/modular
logic elements, bus mounted elements,
relays, electrical operators,
impulse-counters, timers*

Catalogue No.: PDOC 00029UK01ev

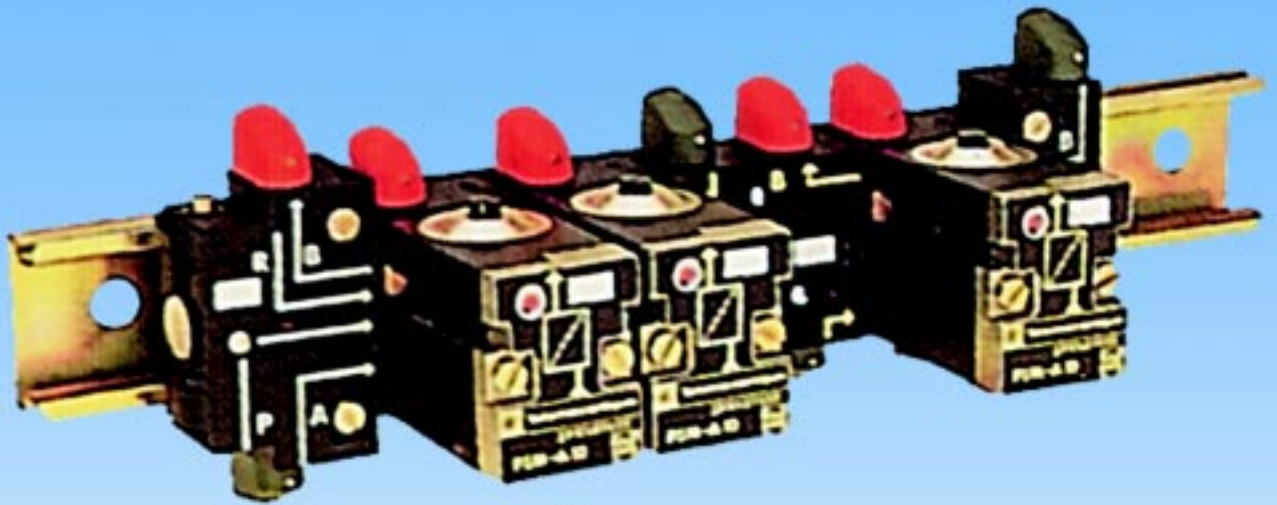

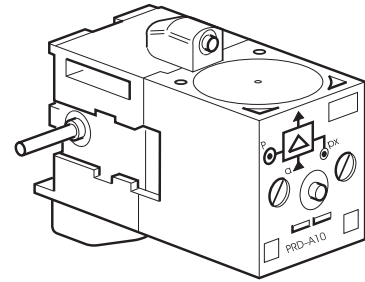

- Complete range
- Stand alone or stackable and combinable modules
- Very fast response time
- Visual indicator
- Flexible and highly maintainable system
- DIN rail mounting



Operating information

Working pressure	3 to 8 bar
Working temperature	-15 °C to 60 °C
Flow (acc. ISO 6358)	General Qmax=180 NI/min PRD Qmax=90 NI/min PRS Qmax=60 NI/min

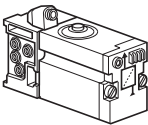

Step modules

Type	Symbol	Logic function	Description	Swivel push-in* connection	Weight Kg	Order code	D
		Visual indication of pneumatic output and manual override	With PSB-A12 subbase	Ø4 mm	0,175	PSM-A12	1
		Without manual override	With PSB-A12 subbase	Ø4 mm	0,170	PSM-B12	3

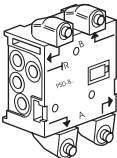

Set of head and tail modules

Type	Symbol	Logic function	Swivel push-in* connection	Weight Kg	Order code	D
		Ø6 mm push-in swivel connection	Ø4 mm	0,080	PSE-A12	1

Deviation modules

Type	Symbol	Logic function	Swivel push-in* connection	Weight Kg	Order code	D
		Used for parallel-, optional-, repeat sequenses and skip step	Ø4 mm	0,050	PSD-A12	1
		for the remote reset of the last step module		0,050	PSD-B12	3

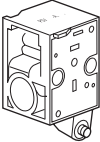

Additional step module interlock

Type	Symbol	Logic function	Swivel push-in* connection	Weight Kg	Order code	D
		May be mounted between the subbase and the step module to interrupt the sequence if a sensor is found to be faulty	Ø4 mm	0,045	PSV-A12	3

* For other type of connections contact Technical Sales Department

Step module without subbase

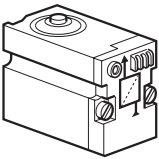
To be used with PSB-A12 subbases



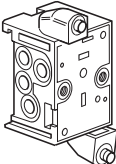

Type	Symbol	Logic function	Description	Weight Kg	Order code	D
			Visual indication of pneumatic output	0,135	PSM-A10	1
			Without manual override	0,130	PSM-B10	3

Step module subbase



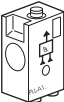

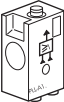

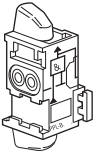

Type	Description	Swivel push-in* connection	Weight Kg	Order code	D
	Subbase	Ø4 mm	0,040	PSB-A12	1

* For other type of connections contact technical sales Technical Sales Department

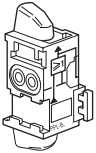

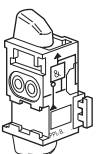

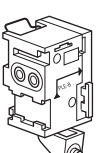

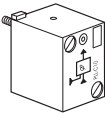

Main data for Line mounted elements

Type	Symbol	Logic function	Description	Connection*	Weight Kg	Order code	D
		AND	Single module	Ø4 mm Straight push-in	0,07	PLL-A11	1
		OR	Single module	Ø4 mm Straight push-in	0,07	PLK-A11	1
		Screw and clip assembly	Enables line mounted logic elements to be attached to DIN rail (Sold per pack of 10)		0,02	PZM-L199	1

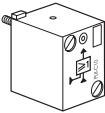
Main data for Combinable elements

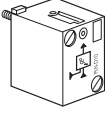

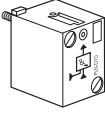



Type	Symbol	Logic function	Description	Connection*	Weight Kg	Order code	D
		AND	With built-in key for combination and operating mode selection	Ø4mm Swivel push-in	0,08	PLL-B12	1
		OR	With built-in key for combination and operating mode selection	Ø4mm Swivel push-in	0,08	PLK-B12	1
		NOT	With built-in key for combination and operating mode selection	Ø4mm Swivel push-in	0,08	PLN-B12	1
		INPUT	With built-in key for combination, clip for mounting on DIN rail and blankingplate for closing a bank of combined elements	Ø4mm swivel push-in	0,08	PLE-B12	1

Main data for Subbase mounted elements

Type	Symbol	Logic function	Description	Connection*	Weight Kg	Order code	D
(For use with 3 port subbase, type PZU•• please see page 3-4)							
		AND	With visual indication of pneumatic output signal		0,03	PLL-C10	1
		OR	With visual indication of pneumatic output signal		0,03	PLK-C10	1
		NOT inhibit standard	With visual indication of pneumatic input/output signal		0,03	PLN-C10	1
		NOT inhibit threshold	With visual indication of pneumatic input/output signal		0,03	PLN-D10	1

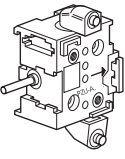
* For other type of connections contact Technical Sales Department

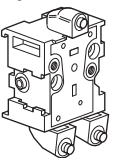

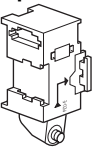
Subbase mounted elements

Type	Symbol	Logic function	Description	Connection*	Weight Kg	Order code	D
For subbase PZU**							
		YES regenerate	With visual indication of pneumatic input/output signal		0,03	PLJ-C10	1
3-port subbases**							
			With common input	Ø4 mm Swivel push-in	0,04	PZU-A12	1
			Cascade	Ø4 mm Swivel push-in	0,05	PZU-C12	1
4-port subbases**							
			For combination with memory relay (see page 3-5) and amplifier relay (see page 3-5)	Ø4 mm Swivel push-in	0,05	PZU-B12	1
Input module							
				Ø4 mm Swivel push-in	0,05	PZU-E12	1

* For other type of connections contact Technical Sales Department

** Can be used singly or in combination. Mounting methods: On DIN rail with built in clip, on surface mounting using screws M4x25

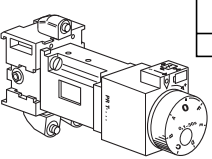
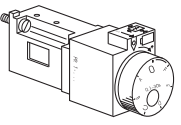
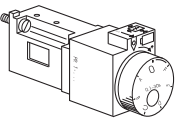



Main data for time delay relays

Type	Function	Timing range	Connection *	Weight Kg	Order code	D	
Complete with Subbase PZU-A12							
		Output after timed period	0,1 to 30 s	Ø4 mm Swivel push-in	0,17	PRT-A12	
Without subbase							
		Output after	0,1 to 3 s	Ø4 mm Swivel push-in	0,13	PRT-E10	
			timed period		0,1 to 30 s	0,13	PRT-A10
					10 to 180 s	0,13	PRT-B10
		Output during	0,1 to 3 s	0,13	PRT-F10	1	
		timed period **	0,1 to 30 s	0,13	PRT-C10	1	
			10 to 180 s	0,13	PRT-D10	1	
Tamper proof cap					0,01	LA9-D901	3

* For other type of connections contact Technical Sales Department

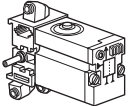
** Can be used to provide an impulse generator



Main data for Memory relays

Type	Symbol	Description	Connection*	Weight Kg	Order code	D
Complete with subbase PZU-B12 		With priority reset signal and visual indication With manual override	Ø4 mm Swivel push-in	0,19	PLM-A12	1
Without subbase For subbase PZU-B12 		With priority reset signal and visual indication With manual override		0,14	PLM-A10	1
		Without manual override		0,13	PLM-B10	1

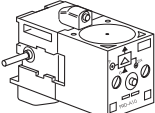
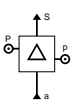
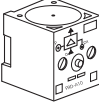
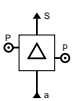
Main data for Amplifier relays

Type	Symbol	Description	Connection*	Weight Kg	Order code	D
Complete with subbase PZU-B12 		This relay is used to amplify the low pressure signal provided by a fluidic proximity sensor to a useable level With manual override	Ø4 mm Swivel push-in	0,18	PRD-A12	3
Without subbase For subbase PZU-B12 		This relay is used to amplify the low pressure signal provided by a fluidic proximity sensor to a useable level With manual override		0,13	PRD-A10	1

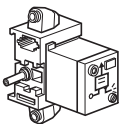
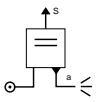
Main data for Sensor relays

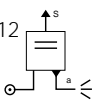
Type	Symbol	Description	Connection*	Weight Kg	Order code	D
Complete with subbase PZU-A12 		This relay is used to supply a bleed sensor and to generate a pneumatic signal equal to its supply pressure	Ø4 mm Swivel push-in	0,07	PRF-A12	3
Without subbase For subbase PZU-A12 or PZU-C12 		This relay is used to supply a bleed sensor and to generate a pneumatic signal equal to its supply pressure		0,03	PRF-A10	1

* For other type of connections contact your Technical Sales Department



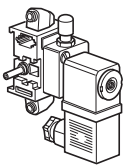
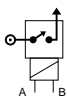
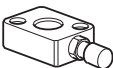
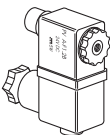



Main data for Solenoid actuators

Type	Symbol	Voltage	Load	Connection	Weight Kg	Order code	D
Complete units, solenoid and cable plug							
		24 V ~ 50/60 Hz	8,5 VA	Manual override	22 mm Plug-in	0,17	PRS-A121B 3
		24 V	6 W	Manual override	22 mm Plug-in	0,17	PRS-A122B 3
		115 V ~ 50 Hz 120 V ~ 60 Hz	8,5 VA	Manual override	22 mm Plug-in	0,17	PRS-A121F 3
		230 V ~ 50 Hz 240 V ~ 60 Hz	8,5 VA	Manual override	22 mm Plug-in	0,17	PRS-A121M 1
Solenoid mounting base							
		For mounting the solenoid coil and plunger on 3-port modular subbases type PZU-A••, see page 3-4		Manual override		0,09	PRS-D10 1
Solenoid coil							
with plunger and 22 mm plug-in connector ** 		24 V*	6 W			0,135	PVA-F102B 1
		48 V*	6 W			0,135	PVA-F102E 3
		24 V~ 50/60 Hz	8,5 VA			0,135	PVA-F101B 1
		48 V~ 50/60 Hz	8,5 VA			0,135	PVA-F101E 3
		115 V~ 50 Hz/ 120 V~ 60 Hz	8,5 VA			0,135	PVA-F101F 1
		230 V~ 50 Hz	8,5 VA			0,135	PVA-F101M 1
		240 V~ 60 Hz 255 V~ 50 Hz	8,5 VA			0,135	PVA-F101U 3

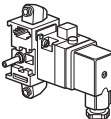
* Versions available for operation in explosive atmospheres.
 - Conforming to certificate LCIE 866115X
 - Electrical equipment conforming to harmonised European standards

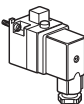
EN 50014 dated March 1977 (NFC 23514 dated May 1982)
 EN 50019 dated March 1977 (NFC 23519 dated May 1982)
 - Referencing code EExe II T4 (consult Technical Sales Department)
 ** Can be fitted with LED indicator and suppression, PVA•ZF••

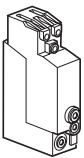
Main data for Pressure switches

Type	Symbol	Electrical characteristics	Pneumatic characteristics	Connection Electric/Pneumatic	Weight Kg	Order code	D
Complete unit with subbase, solenoid and cable plug							
		N/O contact		Manual override	22 mm Plug-in Ø4 mm Swivel push-in	0,13	PRE-A12 1
Without subbase							
		N/O contact		Manual override	22 mm Plug-in Ø4 mm Swivel push-in	0,04	PRE-A10 1
Line mounted							
		1 CO contact 5 A/250 V	Fixed operating threshold	Manual override	Ø4 mm Push-in	0,05	PS1-P1081 1
		1 CO contact 5 A/250 V	Adjustable operating threshold	Manual override	Ø4 mm Push-in	0,05	PS1-P1091 1

Main data for Impulse counters

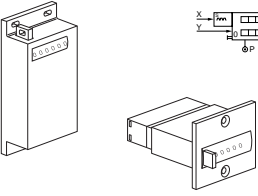
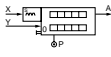
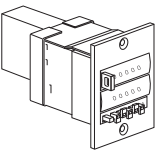
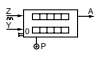
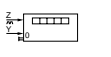
Type	Symbol	Type	Counting range	Mounting	Weight Kg	Order code	D
Totalising counters							
		Pneumatic or manual reset	0 - 999 999	Surface mounting	0,08	PCT-A11	3
				Flush mounting	0,06	PCT-B11	3
Pre-selection counters							
		Additional with pneumatic or manual reset	0 - 99 999	Flush mounting	0,12	PCP-A11	3
		Auto reset	0 - 99 999	Flush mounting		PCP-A111	3
			Subtraction with pneumatic or manual reset	0 - 99 999	Flush mounting	0,11	PCP-S11

Main data for Timers

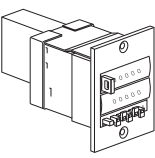
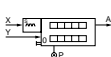
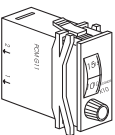
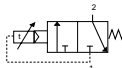
Type	Symbol	Type	Time base	Time range	Weight Kg	Order code	D
Digital display							
		With pneumatic or manual reset	1 second	1 second to 27 hours	0,20	PCM-A11	3
			1 minute	1 minute to 69 days	0,20	PCM-B11	3
			2 minute	3 to 100 minutes	0,20	PCM-E11	3
Calibrated dial							
			1 second	2 to 30 seconds	0,05	PCM-F11	3
			1 second	20 to 300 seconds	0,05	PCM-G11	3

Mounting bezels

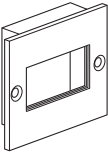
Type	Description	Weight Kg	Order code	D
	For PCM-F11 and PCM-G11 mounting in 60 x 75 mm cut-out	0,015	PXC-ZM6075	3
	For PCM-F11 and PCM-G11 mounting in 72 x 72 mm cut-out	0,015	PXC-ZM7272	3

Bezels for DIN rail mounting

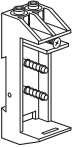
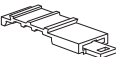
Type	Description	Weight Kg	Order code	D
	For (non-reversible) clip-on mounting of PCM-F11 and PCM-G11 on push-in connection subbase	0,020	PXC-ZA35	3
	35 mm DIN rail latching device for PXC-ZA35 subbases	0,010	PXC-ZE35	3

Lockable cover

Degree of protection IP 55

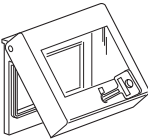
Type	Description	Weight Kg	Order code	D
	Transparent cover key lockable for 60x75 bezel for PCP-A11, PCP-S11, PCP-MA11, PCP-MB11	0,025	PXC-B1	3
	For PCT-B11	0,018	PXC-A1	3

Logic Processing

Dimensions, Logic processing

Modular sequencer

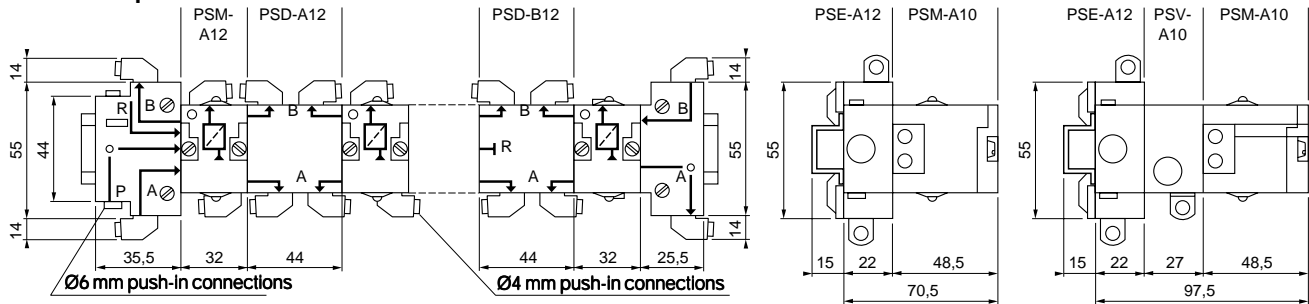

Line mounted logic elements

PLL-A11 and PLK-A11

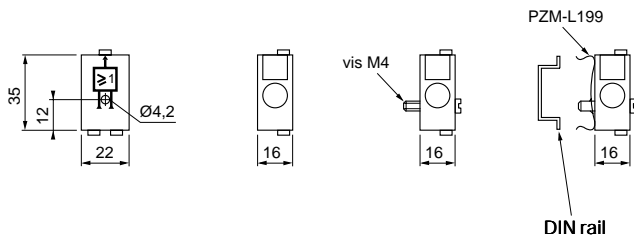

Combinable logic elements

PLE-B12 — PLL-B12 — PLK-B12 and PLN-B12

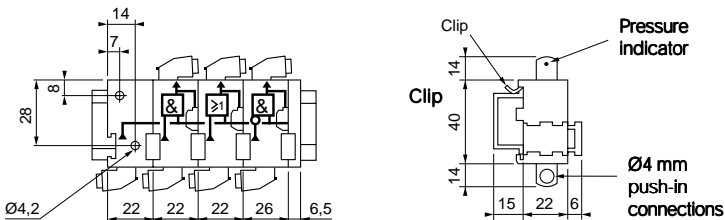

Logic elements mounted on 3-port modular subbases

PZU-E12

PLJ-C10 — PLN-C10 — PLK-C10 and PLL-C10 mounted on PZU-C12 and PZU-A12

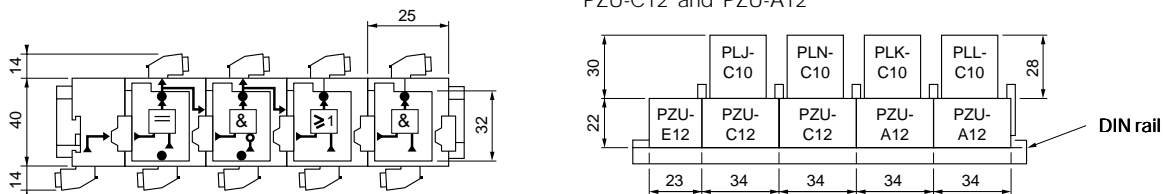

Logic Processing

3 and 4-port modular subbases

PZU-E12 — PZU-C12 — PZU-A12

PZU-B12

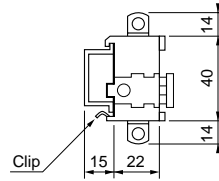
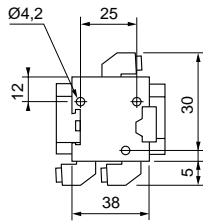
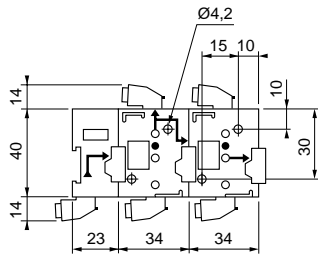

Relays mounted on 3-port modular subbases

PRT-A12 — PRF-A12 — PRE-A12 — PRS-A121 and PLN-D12

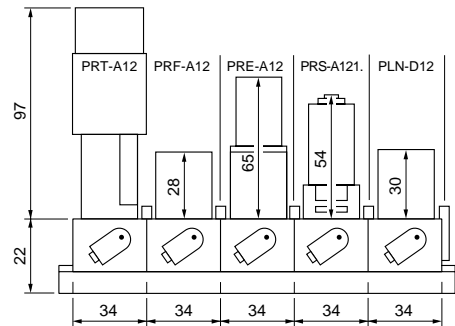
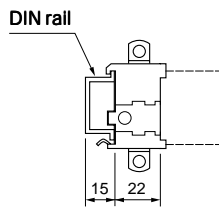
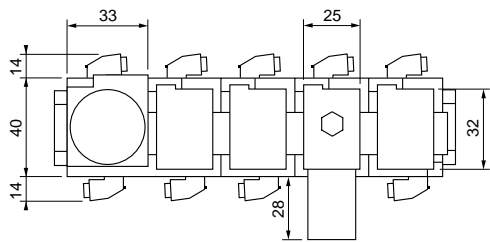

Relays mounted on 4-port modular subbases

PLM-A12 and PRD-A12

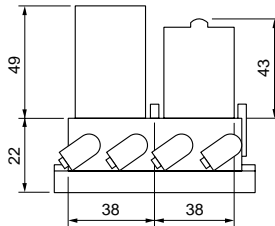
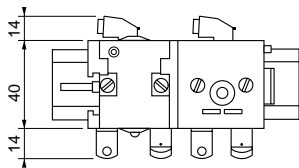

Pressure switch

PS1-P1091

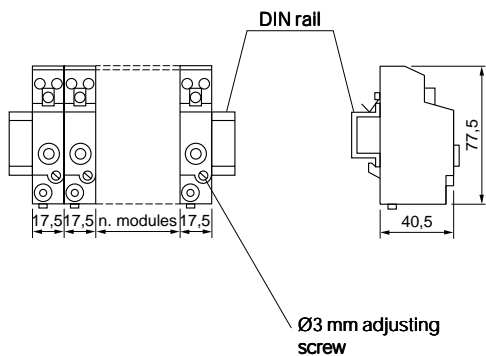

Logic Processing

Totalling counters

PCT-A11 PCT-B11

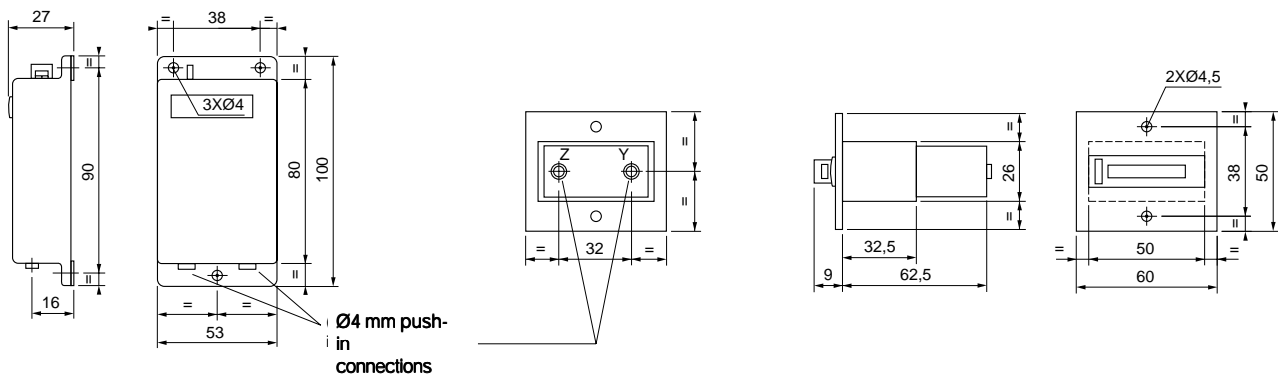

Preselection counters

PCP-A11 and PCP-S11

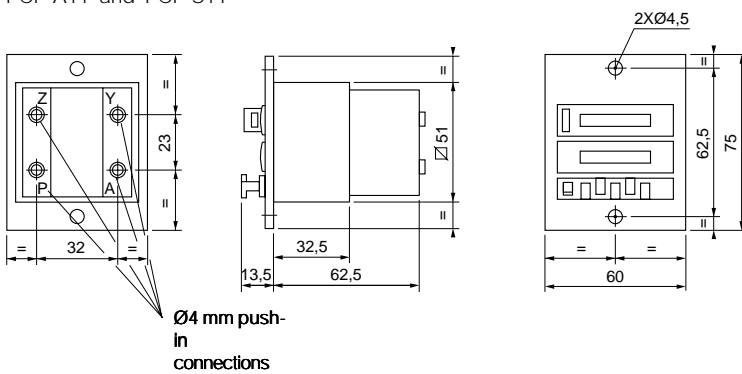

Digital display timers

PCM-A11 and PCM-B11

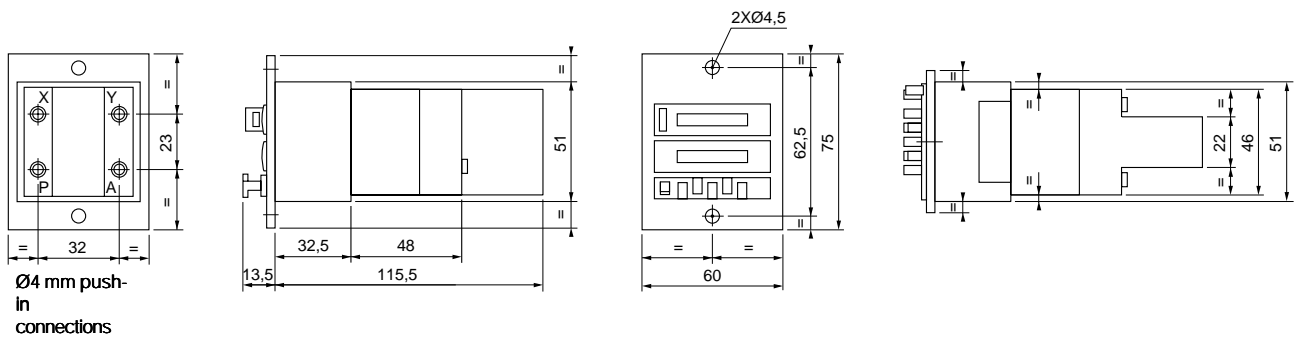

Timers with calibrated dial

PCM-F11 and PCM-G11

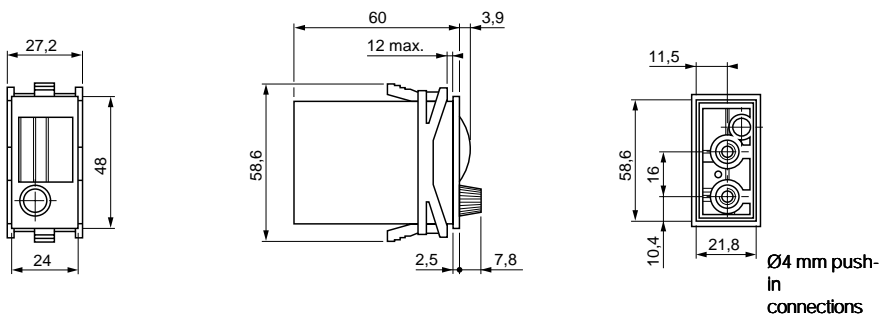

Service and Replacement Parts

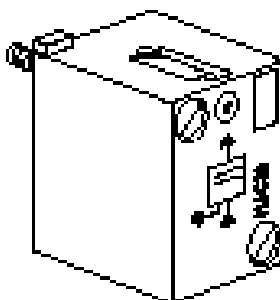

Logic Processing

No internal components available, **replace complete element or base**

Spare Part Kits

Part Number	Description	Quantity per Kit
PPR-L01	Interface seals, step sequencer/ base	10 seals
PPR-L02	Interface seals, elements/ 4 port sub-base	10 seals
PPR-L05	Plugs for 3 or 4 port sub-bases	50 plugs
PPR-L06	Combination key for combinable elements	50 keys
PPR-L07	Combination key for modular sub-bases	50 keys
PPR-L08	Diaphragm for amplifier relay	10 diaphragms
PPR-L09	Head & Tail set DIN rail retainers	20 sets
PPR-L10	Position selector for combinable elements	50 selectors
PPR-L11	Interface seals for step sequencer and combinable elements	100 ,O' ring seals