

PRK 46B

Retro-reflective photoelectric sensors with polarisation filter

en 11-2011/01 50109007-01



0.05 ... 18m



- Polarized retro-reflective photoelectric sensor
- Fast alignment through *brightVision*®
- A²LS - Active Ambient Light Suppression
- Push-pull switching outputs
- Relay output - for operation without reference potential
- Operating range adjustment
- Warning output - for increased availability

Dimensioned drawing

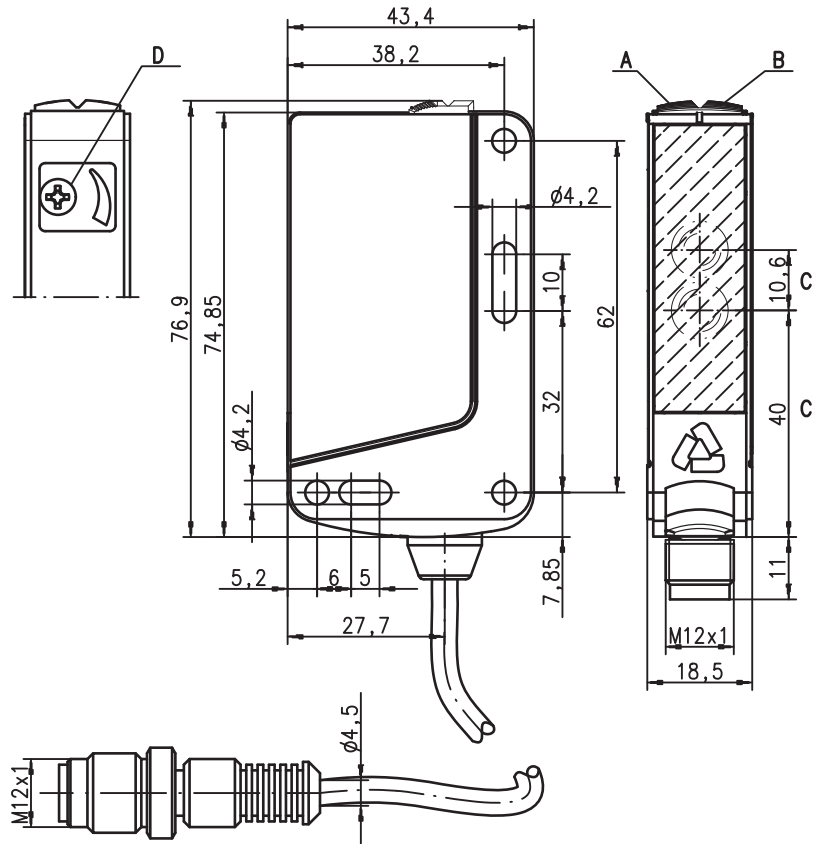

- A** Green indicator diode
- B** Yellow indicator diode
- C** Optical axis
- D** Optional operating range adjustment

Electrical connection

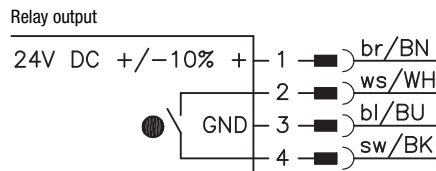
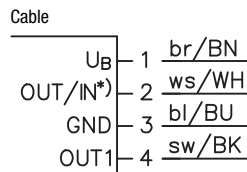
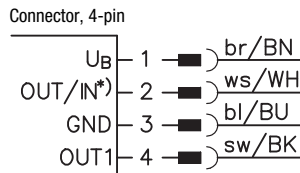

Selection pin 2

*)	OUT	IN
	OUT 2	active
	warn	
	NC	

We reserve the right to make changes • DS_PRK_46B_66_en.fm



Accessories:

(available separately)

- Mounting systems (BT 46, BT 46.1, BT 46.1.5, BT 46.2)
- M12 connectors (KD ...)
- Ready-made cables (K-D ...)
- Reflectors
- Reflective tapes

Specifications

Optical data

Typ. op. range limit (TK(S) 100x100) ¹⁾ 0.05 ... 18m
 Operating range ²⁾ see tables
 Light source ³⁾ LED (modulated light)
 Wavelength 620nm (visible red light, polarized)

Timing

Switching frequency transistor: 500Hz, relay: 20Hz
 Response time transistor: 1 ms, relay: 25ms
 Delay before start-up ≤ 300ms

Electrical data

With transistor switching outputs

Operating voltage U_B ⁴⁾ 10 ... 30VDC (incl. residual ripple)
 Residual ripple ≤ 15% of U_B
 Open-circuit current ≤ 20mA
 Switching output .../66. ... 2 push-pull switching outputs ⁵⁾
 .../44. ... pin 2: PNP dark switching, NPN light switching
 .../4. ... pin 4: PNP light switching, NPN dark switching
 Signal voltage high/low 2 PNP switching outputs, pin 2: PNP dark switching,
 Output current pin 4: PNP light switching
 Switching output.../7D ... PNP switching output, pin 4: light switching
 ≥ ($U_B - 2V$) / ≤ 2V
 max. 100mA

With relay switching output

Operating voltage U_B 24VDC ±10%
 Open-circuit current ≤ 30mA
 Switching output.../7D ... relay, make-contact between pin 2 and pin 4,
 dark switching ⁶⁾
 Switching voltage/switching current 30VAC/DC / max. 200mA
 Switching power 6VA, cos φ = 1
 Operating range adjustable, 270° (PRK 46B/66.01-S12 only)

Indicators

Green LED ready
 Yellow LED light path free
 Yellow LED, flashing light path free, no performance reserve

Mechanical data

Housing plastic (PC-ABS)
 Optics cover plastic (PMMA)
 Weight with connector: 50g
 with 2m cable: 90g
 with cable and connector: 65g
 M12 connector or
 cable (4 x 0.21mm² cross section), cable length: 2m, or
 cable with M12 connector, cable length: 200mm

Connection type

Environmental data

Ambient temp. (operation/storage) -40°C ... +60°C / -40°C ... +70°C
 Protective circuit ⁷⁾ 2, 3
 VDE safety class ⁸⁾ II, all-insulated
 Protection class IP 67, IP 69K
 LED class 1 (acc. to EN 60825-1)
 Standards applied IEC 60947-5-2
 Certifications UL 508 ⁴⁾

Options

Warning output autoControl PNP transistor, counting principle
 Signal voltage high/low ≥ ($U_B - 2V$) / ≤ 2V
 Output current max. 100mA
Activation input active ≥ 8V / ≤ 2V
 Transmitter active/not active ≤ 1ms / ≤ 2ms
 Activation/disable delay 10KΩ ± 10%
 Input resistance

- 1) Typ. operating range limit: max. attainable range without performance reserve
- 2) Operating range: recommended range with performance reserve
- 3) Average life expectancy 100,000 h at an ambient temperature of 25°C
- 4) For UL applications: for use in class 2 circuits only
- 5) The push-pull switching outputs must not be connected in parallel
- 6) Suitable spark extinction must be provided with inductive or capacitive loads
- 7) 2=polarity reversal protection, 3=short-circuit protection for all transistor outputs
- 8) Rating voltage 50V

Tables

Reflectors	Operating range
1 TK(S) 100x100	0.05 ... 15m
2 TK 82.2	0.25 ... 11m
3 TK(S) 50x50	0.05 ... 10m
4 TK(S) 40x60	0.05 ... 8m
5 TK(S) 20x40	0.05 ... 3m
6 Tape 4 50x50	0.2 ... 2m

1 0.05	15	18
2 0.25	11	14
3 0.05	10	1
4 0.05	8	1
5 0.05	3	5
6 0.2	2	3

Operating range [m]
 Typ. operating range limit [m]

TK ... = adhesive
 TK(S) ... = screw type
 Tape 4 = adhesive

Diagrams

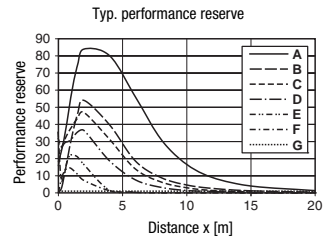
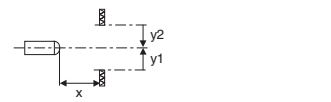
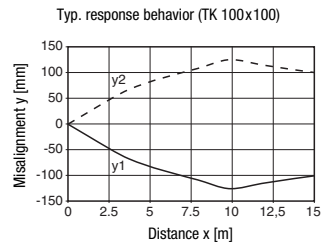

- A TK 100x100
- B TK 82.2
- C TK 50x50
- D TKS 40x60
- E TKS 20x40
- F Tape 4 50x50
- G Switching point

Remarks

- **Approved purpose:**
 This product may only be used by qualified personnel and must only be used for the approved purpose. This sensor is not a safety sensor and is not to be used for the protection of persons.

PRK 46B

Retro-reflective photoelectric sensors with polarisation filter

Order guide

The sensors listed here are preferred types; current information at www.leuze.com.

	Designation	Part No.
With M12 connector		
Complementary switching output	PRK 46B/66-S12	50103070
Warning output, display low performance reserve	IPRK 46B/4-S12	50103074
Relay output, dark switching	PRK 46B/7D-S12	50103080
Cable with M12 connector		
Complementary switching output	PRK 46B/66, 200-S12	50103071
Cable, cable length 2m		
Complementary switching output	PRK 46B/66	50107068

Type key

I	P	R	K	4	6	B	/	4	D	.	2	-	S	1	2
---	---	---	---	---	---	---	---	---	---	---	---	---	---	---	---

Operating principle

PRK	Polarized retro-reflective photoelectric sensor
IPRK	Polarized retro-reflective photoelectric sensor with warning output

Series

46B	46B Series
------------	------------

Switching output

/66	Complementary push-pull switching outputs
/44	Complementary PNP switching outputs
/4	Pin 4 PNP switching output, pin 2 no contact, warning output or activation input
/6	Pin 4 push-pull switching output, pin 2 no contact
/7D	Relay, break-contact

Function characteristics

N/A	Pin 4 light switching; with push-pull, PNP light switching
D	Inverted switching logic

Special function

.2	No false switching to stretch-wrapped and shrink-wrapped containers
.8	Activation input
.01	Sensitivity adjustment

Combinations of functions are possible via two-digit code

Electrical connection

N/A	Cable, standard length 2000mm
,200-S12	Cable, length 200 mm with M12 connector
-S12	M12 connector

