

### Fotocellule M18 con regolazione laterale - DC serie SS-SP

*M18 photoelectric sensors with side sens. adjust - DC SS-SP series*



### Caratteristiche principali Main features

- > Modelli con regolazione laterale con ottica assiale ed a 90°  
> *Models with side sens. adjustment on axial and right angle optic*
- > Stato dell'uscita: impulso luce / impulso buio selezionabile  
> *LO/DO selectable output*
- > Grado di protezione IP67 per tutti i modelli  
> *IP67 protection degree for all models*
- > Disponibili, su richiesta, modelli ATEX, cat. 3  
> *ATEX models, cat. 3, available on request*
- > Indicatore LED su tutti i modelli  
> *LED status indicator for all versions*
- > Totalmente protetti contro danneggiamenti di tipo elettrico  
> *Complete protection against electrical damages*
- > Approvazioni: CE e cULus listed  
> *Approvals: CE and cULus listed*

### Descrizione del codice - Code structure

> Soppressione di sfondo - *Background suppression*

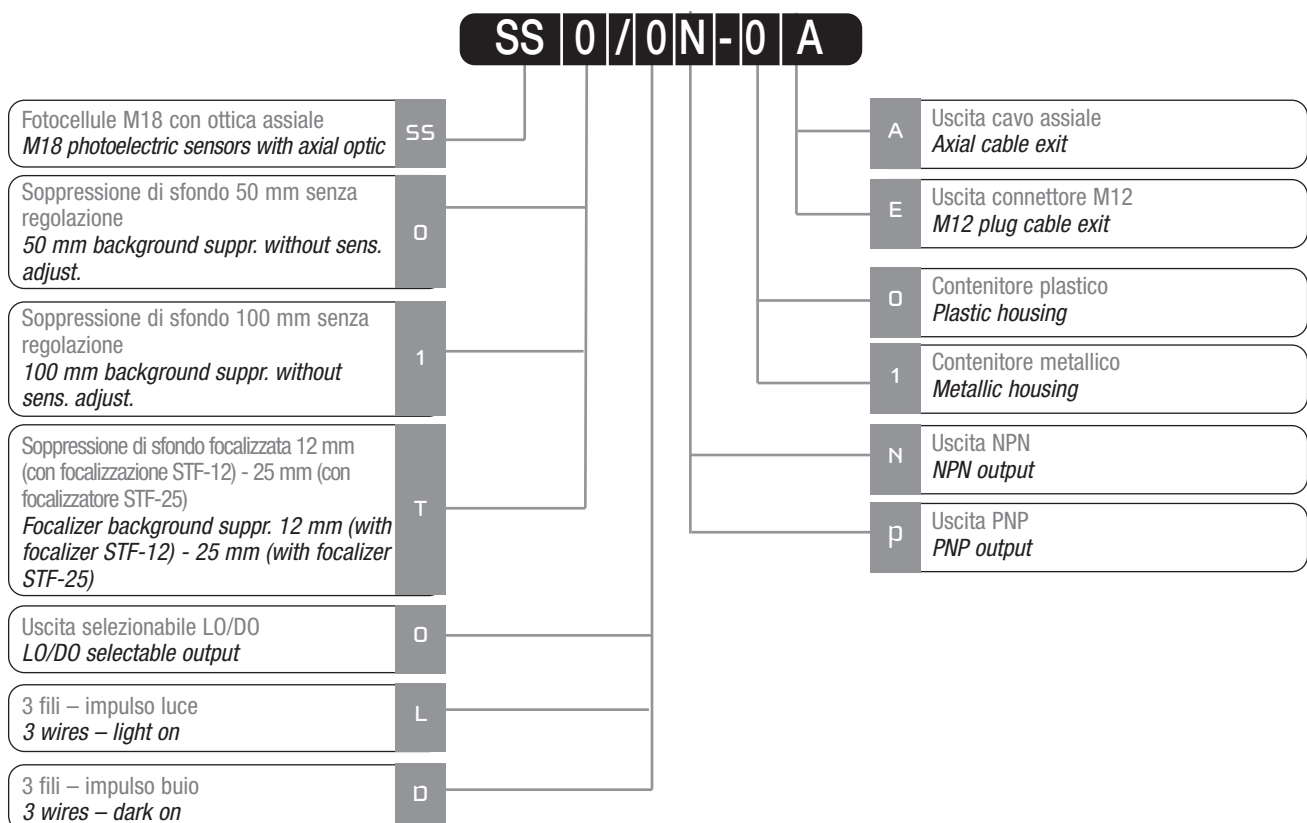

## SS-SP series - CYLINDRICAL PHOTOELECTRIC SENSORS

> Diffusione diretta e catarifrangente - *Diffuse reflection and retro-reflective*



<sup>(1)</sup> Versione speciale con regolazione, variante 3X / *Special version with sens. adjust, 3X variant*

### > Barriera - Through beam

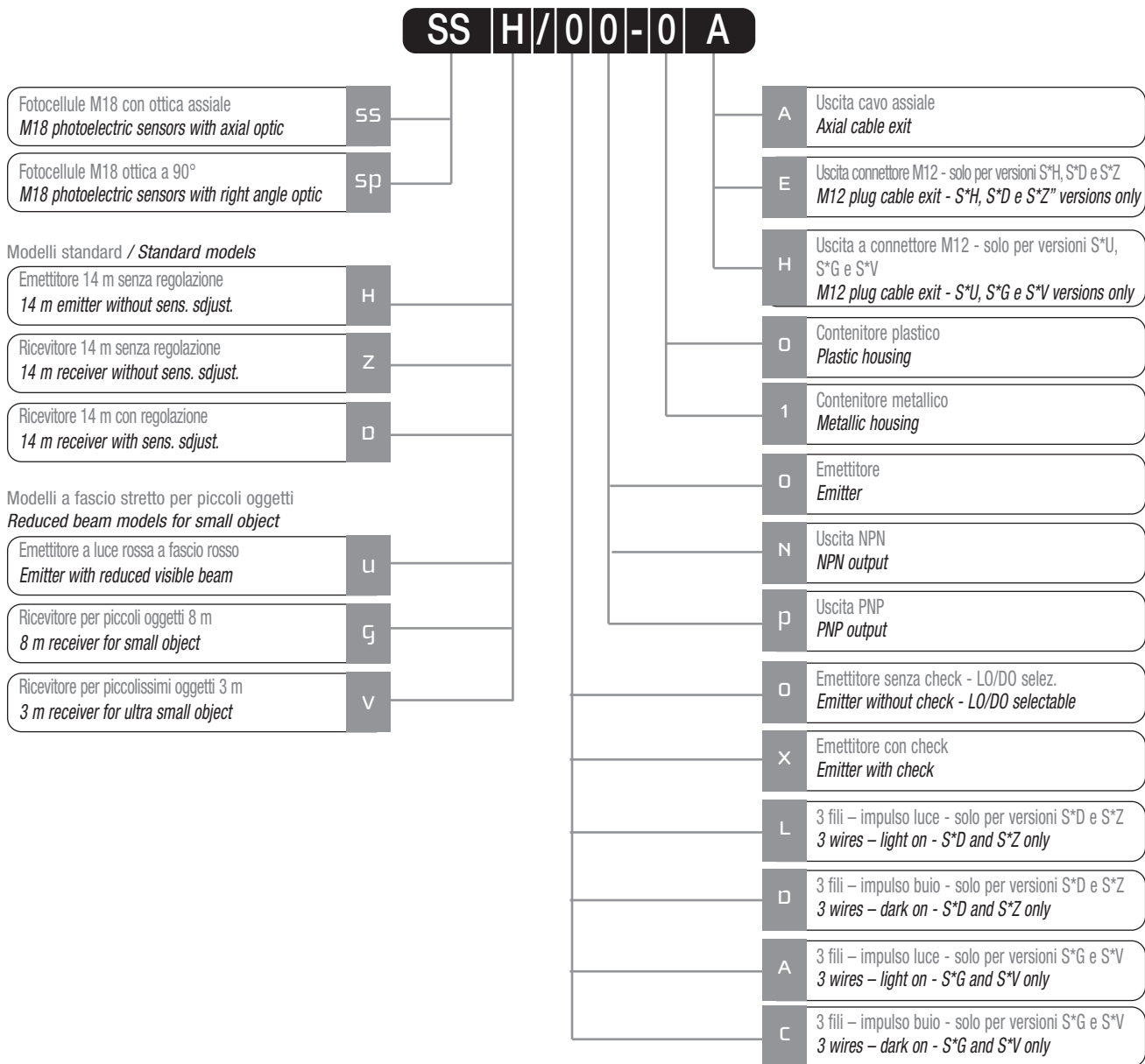

### Modelli disponibili - Available models

> Fotocellule a connettore con ottica assiale - Plug exit photoelectric sensors axial optic

Funzione Model	Portata Distance	Corpo Housing	Regol. Adj.	3 fili / wires LO NPN	3 fili / wires LO PNP	3 fili / wires DO NPN	3 fili / wires DO PNP	4 fili / wires NPN LO/DO	4 fili / wires PNP LO/DO	
Soppr. di sfondo Background suppression	50 mm	Plastico Plastic	No	SS0/LN-0E	SS0/LP-0E	SS0/DN-0E	SS0/DP-0E	SS0/ON-0E	SS0/OP-0E	
		Metallico Metallic		SS0/LN-1E	SS0/LP-1E	SS0/DN-1E	SS0/DP-1E	SS0/ON-1E	SS0/OP-1E	
	100 mm	Plastico Plastic	No	SS1/LN-0E	SS1/LP-0E	SS1/DN-0E	SS1/DP-0E	SS1/ON-0E	SS1/OP-0E	
		Metallico Metallic		SS1/LN-1E	SS1/LP-1E	SS1/DN-1E	SS1/DP-1E	SS1/ON-1E	SS1/OP-1E	
	Focalizzata Focalized		Plastico Plastic	No	SST/LN-0E	SST/LP-0E	SST/DN-0E	SST/DP-0E	SST/ON-0E	SST/OP-0E
			Metallico Metallic		SST/LN-1E	SST/LP-1E	SST/DN-1E	SST/DP-1E	SST/ON-1E	SST/OP-1E
Tasteggio diretto Diffuse reflection	100 mm	Plastico Plastic	No	SS2/LN-0E	SS2/LP-0E	SS2/DN-0E	SS2/DP-0E	SS2/ON-0E	SS2/OP-0E	
		Metallico Metallic	Si / Yes	SS3/LN-0E	SS3/LP-0E	SS3/DN-0E	SS3/DP-0E	SS3/ON-0E	SS3/OP-0E	
	400 mm	Plastico Plastic	No	SS2/LN-1E	SS2/LP-1E	SS2/DN-1E	SS2/DP-1E	SS2/ON-1E	SS2/OP-1E	
		Metallico Metallic	Si / Yes	SS3/LN-1E	SS3/LP-1E	SS3/DN-1E	SS3/DP-1E	SS3/ON-1E	SS3/OP-1E	
	800 mm	Plastico Plastic	Si / Yes	SS7/LN-0E	SS7/LP-0E	SS7/DN-0E	SS7/DP-0E	SS7/ON-0E	SS7/OP-0E	
		Metallico Metallic	Si / Yes	SS7/LN-1E	SS7/LP-1E	SS7/DN-1E	SS7/DP-1E	SS7/ON-1E	SS7/OP-1E	
Catarifrangente Retro-reflective	4 m	Plastico Plastic	No	SSC/LN-0E	SSC/LP-0E	SSC/DN-0E	SSC/DP-0E	SSC/ON-0E	SSC/OP-0E	
		Metallico Metallic	Si / Yes	SSC/LN-1E	SSC/LP-1E	SSC/DN-1E	SSC/DP-1E	SSC/ON-0E3X	SSC/OP-0E3X	
	3 m	Plastico Plastic	No	SSP/LN-0E	SSP/LP-0E	SSP/DN-0E	SSP/DP-0E	SSP/ON-0E	SSP/OP-0E	
		Metallico Metallic	Si / Yes	SSP/LN-1E	SSP/LP-1E	SSP/DN-1E	SSP/DP-1E	SSP/ON-0E3X	SSP/OP-0E3X	
Barriera Through-beam	14 m	Plastico Plastic	Emettitore / Emitter	SSH/00-0E						
			Em con / With check	SSH/X0-0E						
			Ricev. / Receiv.	SSZ/LN-0E	SSZ/LP-0E	SSZ/DN-0E	SSZ/DP-0E	SSZ/ON-0E	SSZ/OP-0E	
			Ricev.reg / Receiv.reg	SSD/LN-0E	SSD/LP-0E	SSD/DN-0E	SSD/DP-0E	SSD/ON-0E	SSD/OP-0E	
	8 m	Metallico Metallic	Emettitore / Emitter	SSH/00-1E						
			Em con / With check	SSH/X0-1E						
			Ricev. / Receiv.	SSZ/LN-1E	SSZ/LP-1E	SSZ/DN-1E	SSZ/DP-1E	SSZ/ON-1E	SSZ/OP-1E	
			Ricev.reg / Receiv.reg	SSD/LN-1E	SSD/LP-1E	SSD/DN-1E	SSD/DP-1E	SSD/ON-1E	SSD/OP-1E	
	3 m	Plastico Plastic	Emettitore / Emitter	SSU/00-0E						
			Em con / With check	SSU/X0-0E						
			Ricev. / Receiv.	SSG/AN-0E	SSG/AP-0E	SSG/CN-0E	SSG/CP-0E			
			Emettitore / Emitter	SSU/00-1H						
8 m	Metallico Metallic	Em con / With check	SSU/X0-1H							
		Ricev. / Receiv.	SSG/AN-1H	SSG/AP-1H	SSG/CN-1H	SSG/CP-1H				
		Emettitore / Emitter	SSU/00-0E							
		Em con / With check	SSU/X0-0E							
3 m	Plastico Plastic	Ricev. / Receiv.	SSV/AN-0E	SSV/AP-0E	SSV/CN-0E	SSV/CP-0E				
		Emettitore / Emitter	SSU/00-1H							
		Em con / With check	SSU/X0-1H							
		Ricev. / Receiv.	SSV/AN-1H	SSV/AP-1H	SSV/CN-1H	SSV/CP-1H				

> Fotocellule a cavo con ottica assiale - Cable exit photoelectric sensors axial optic

Funzione Model	Portata Distance	Corpo Housing	Regol. Adj.	3 fili / wires LO NPN	3 fili / wires LO PNP	3 fili / wires DO NPN	3 fili / wires DO PNP	4 fili / wires NPN LO/DO	4 fili / wires PNP LO/DO
Soppr. di sfondo Background suppression	50 mm	Plastico Plastic	No	SS0/LN-0A	SS0/LP-0A	SS0/DN-0A	SS0/DP-0A	SS0/ON-0A	SS0/OP-0A
		Metallico Metallic		SS0/LN-1A	SS0/LP-1A	SS0/DN-1A	SS0/DP-1A	SS0/ON-1A	SS0/OP-1A
	100 mm	Plastico Plastic	No	SS1/LN-0A	SS1/LP-0A	SS1/DN-0A	SS1/DP-0A	SS1/ON-0A	SS1/OP-0A
		Metallico Metallic		SS1/LN-1A	SS1/LP-1A	SS1/DN-1A	SS1/DP-1A	SS1/ON-1A	SS1/OP-1A
	Focalizzata Focalized	Plastico Plastic	No	SST/LN-0A	SST/LP-0A	SST/DN-0A	SST/DP-0A	SST/ON-0A	SST/OP-0A
				Metallico Metallic	SST/LN-1A	SST/LP-1A	SST/DN-1A	SST/DP-1A	SST/ON-1A
Tasteggio diretto Diffuse reflection	100 mm	Plastico Plastic	No	SS2/LN-0A	SS2/LP-0A	SS2/DN-0A	SS2/DP-0A	SS2/ON-0A	SS2/OP-0A
		Metallico Metallic	Si / Yes	SS3/LN-0A	SS3/LP-0A	SS3/DN-0A	SS3/DP-0A	SS3/ON-0A	SS3/OP-0A
		Metallico Metallic	No	SS2/LN-1A	SS2/LP-1A	SS2/DN-1A	SS2/DP-1A	SS2/ON-1A	SS2/OP-1A
	400 mm	Plastico Plastic	Si / Yes	SS7/LN-0A	SS7/LP-0A	SS7/DN-0A	SS7/DP-0A	SS7/ON-0A	SS7/OP-0A
		Metallico Metallic	Si / Yes	SS7/LN-1A	SS7/LP-1A	SS7/DN-1A	SS7/DP-1A	SS7/ON-1A	SS7/OP-1A
	800 mm	Plastico Plastic	Si / Yes	SS8/LN-0A	SS8/LP-0A	SS8/DN-0A	SS8/DP-0A	SS8/ON-0A	SS8/OP-0A
Metallico Metallic		Si / Yes	SS8/LN-1A	SS8/LP-1A	SS8/DN-1A	SS8/DP-1A	SS8/ON-1A	SS8/OP-1A	
Catarifrangente Retro-reflective	4 m	Plastico Plastic	No	SSC/LN-0A	SSC/LP-0A	SSC/DN-0A	SSC/DP-0A	SSC/ON-0A	SSC/OP-0A
		Metallico Metallic	Si / Yes	SSC/LN-1A	SSC/LP-1A	SSC/DN-1A	SSC/DP-1A	SSC/ON-1A	SSC/OP-1A
		Metallico Metallic	No	SSC/LN-1A	SSC/LP-1A	SSC/DN-1A	SSC/DP-1A	SSC/ON-1A	SSC/OP-1A
Polarizzata Polarized	3 m	Plastico Plastic	No	SSP/LN-0A	SSP/LP-0A	SSP/DN-0A	SSP/DP-0A	SSP/ON-0A	SSP/OP-0A
		Metallico Metallic	Si / Yes	SSP/LN-1A	SSP/LP-1A	SSP/DN-1A	SSP/DP-1A	SSP/ON-1A	SSP/OP-1A
		Metallico Metallic	No	SSP/LN-1A	SSP/LP-1A	SSP/DN-1A	SSP/DP-1A	SSP/ON-1A	SSP/OP-1A
Barriera Through-beam	14 m	Plastico Plastic	Emettitore / Emitter	SSH/00-0A					
			Em. con / With check	SSH/X0-0A					
		Ricev. / Receiv.	SSZ/LN-0A	SSZ/LP-0A	SSZ/DN-0A	SSZ/DP-0A	SSZ/ON-0A	SSZ/OP-0A	
		Ricev.reg / Receiv.reg	SSD/LN-0A	SSD/LP-0A	SSD/DN-0A	SSD/DP-0A	SSD/ON-0A	SSD/OP-0A	
	Metallico Metallic	Emettitore / Emitter	SSH/00-1A						
			Em. con / With check	SSH/X0-1A					
		Ricev. / Receiv.	SSZ/LN-1A	SSZ/LP-1A	SSZ/DN-1A	SSZ/DP-1A	SSZ/ON-1A	SSZ/OP-1A	
		Ricev.reg / Receiv.reg	SSD/LN-1A	SSD/LP-1A	SSD/DN-1A	SSD/DP-1A	SSD/ON-1A	SSD/OP-1A	
	8 m	Plastico Plastic	Emettitore / Emitter	SSU/00-0A					
			Em. con / With check	SSU/X0-0A					
		Ricev. / Receiv.	SSG/AN-0A	SSG/AP-0A	SSG/CN-0A	SSG/CP-0A			
		Emettitore / Emitter	SSU/00-1A						
Metallico Metallic	Em. con / With check	SSU/X0-1A							
	Ricev. / Receiv.	SSG/AN-1A	SSG/AP-1A	SSG/CN-1A	SSG/CP-1A				
3 m	Plastico Plastic	Emettitore / Emitter	SSU/00-0A						
		Em. con / With check	SSU/X0-0A						
	Ricev. / Receiv.	SSV/AN-0A	SSV/AP-0A	SSV/CN-0A	SSV/CP-0A				
	Metallico Metallic	Emettitore / Emitter	SSU/00-1A						
Em. con / With check		SSU/X0-1A							
Ricev. / Receiv.	SSV/AN-1A	SSV/AP-1A	SSV/CN-1A	SSV/CP-1A					

## SS-SP series - CYLINDRICAL PHOTOELECTRIC SENSORS

> Fotocellule a connettore con ottica radiale - *Plug exit photoelectric sensors radial optic*

Funzione Model	Portata Distance	Corpo Housing	Regol. Adj.	3 fili / wires LO NPN	3 fili / wires LO PNP	3 fili / wires DO NPN	3 fili / wires DO PNP	4 fili / wires NPN LO/DO	4 fili / wires PNP LO/DO	
Tasteggio diretto Diffuse reflection	100 mm	Plastico Plastic	No	SP2/LN-0E	SP2/LP-0E	SP2/DN-0E	SP2/DP-0E	SP2/ON-0E	SP2/OP-0E	
		Plastico Plastic	Si / Yes	SP3/LN-0E	SP3/LP-0E	SP3/DN-0E	SP3/DP-0E	SP3/ON-0E	SP3/OP-0E	
	400 mm	Metallico Metallic	No	SP2/LN-1E	SP2/LP-1E	SP2/DN-1E	SP2/DP-1E	SP2/ON-1E	SP2/OP-1E	
		Metallico Metallic	Si / Yes	SP3/LN-1E	SP3/LP-1E	SP3/DN-1E	SP3/DP-1E	SP3/ON-1E	SP3/OP-1E	
	800 mm	Plastico Plastic	Si / Yes	SP7/LN-0E	SP7/LP-0E	SP7/DN-0E	SP7/DP-0E	SP7/ON-0E	SP7/OP-0E	
		Metallico Metallic	Si / Yes	SP7/LN-1E	SP7/LP-1E	SP7/DN-1E	SP7/DP-1E	SP7/ON-1E	SP7/OP-1E	
Catarifrangente Retro-reflective	4 m	Plastico Plastic	No	SPC/LN-0E	SPC/LP-0E	SPC/DN-0E	SPC/DP-0E	SPC/ON-0E	SPC/OP-0E	
		Plastico Plastic	Si / Yes					SPC/ON-0E3X	SSC/OP-0E3X	
		Metallico Metallic	No	SPC/LN-1E	SPC/LP-1E	SPC/DN-1E	SPC/DP-1E	SPC/ON-1E	SPC/OP-1E	
Polarizzata Polarized	3 m	Metallico Metallic	Si / Yes					SPC/ON-1E3X	SSC/OP-1E3X	
		Plastico Plastic	No	SPP/LN-0E	SPP/LP-0E	SPP/DN-0E	SPP/DP-0E	SPP/ON-0E	SPP/OP-0E	
		Plastico Plastic	Si / Yes					SPP/ON-0E3X	SPP/OP-0E3X	
Barriera Through-beam	14 m	Plastico Plastic	Emettitore / Emitter	SPH/00-0E						
			Em. con / With check	SPH/X0-0E						
			Ricev. / Receiv.	SPZ/LN-0E	SPZ/LP-0E	SPZ/DN-0E	SPZ/DP-0E	SPZ/ON-0E	SPZ/OP-0E	
		Ricev.reg / Receiv.reg	SPD/LN-0E	SPD/LP-0E	SPD/DN-0E	SPD/DP-0E	SPD/ON-0E	SPD/OP-0E		
		Metallico Metallic	Emettitore / Emitter	SPH/00-1E						
			Em. con / With check	SPH/X0-1E						
	Ricev. / Receiv.		SPZ/LN-1E	SPZ/LP-1E	SPZ/DN-1E	SPZ/DP-1E	SPZ/ON-1E	SPZ/OP-1E		
	8 m	Plastico Plastic	Ricev.reg / Receiv.reg	SPD/LN-1E	SPD/LP-1E	SPD/DN-1E	SPD/DP-1E	SPD/ON-1E	SPD/OP-1E	
			Emettitore / Emitter	SPU/00-0E						
			Em. con / With check	SPU/X0-0E						
		Ricev. / Receiv.	SPG/AN-0E	SPG/AP-0E	SPG/CN-0E	SPG/CP-0E				
		Metallico Metallic	Emettitore / Emitter	SPU/00-1E						
			Em. con / With check	SPU/X0-1E						
	Ricev. / Receiv.		SPG/AN-1E	SPG/AP-1E	SPG/CN-1E	SPG/CP-1E				
	3 m	Plastico Plastic	Emettitore / Emitter	SPU/00-0E						
			Em. con / With check	SPU/X0-0E						
			Ricev. / Receiv.	SPV/AN-0E	SPV/AP-0E	SPV/CN-0E	SPV/CP-0E			
		Metallico Metallic	Emettitore / Emitter	SPU/00-1E						
Em. con / With check			SPU/X0-1E							
Ricev. / Receiv.			SPV/AN-1E	SPV/AP-1E	SPV/CN-1E	SPV/CP-1E				

> Fotocellule a cavo con ottica radiale - Cable exit photoelectric sensors radial optic

Funzione Model	Portata Distance	Corpo Housing	Regol. Adj.	3 fili / wires LO NPN	3 fili / wires LO PNP	3 fili / wires DO NPN	3 fili / wires DO PNP	4 fili / wires NPN LO/DO	4 fili / wires PNP LO/DO
Tasteggio diretto Diffuse reflection	100 mm	Plastico Plastic	No	SP2/LN-0A	SP2/LP-0A	SP2/DN-0A	SP2/DP-0A	SP2/ON-0A	SP2/OP-0A
		Plastico Plastic	Si / Yes	SP3/LN-0A	SP3/LP-0A	SP3/DN-0A	SP3/DP-0A	SP3/ON-0A	SP3/OP-0A
	400 mm	Plastico Plastic	No	SP2/LN-1A	SP2/LP-1A	SP2/DN-1A	SP2/DP-1A	SP2/ON-1A	SP2/OP-1A
		Plastico Plastic	Si / Yes	SP3/LN-1A	SP3/LP-1A	SP3/DN-1A	SP3/DP-1A	SP3/ON-1A	SP3/OP-1A
	800 mm	Plastico Plastic	No	SP7/LN-0A	SP7/LP-0A	SP7/DN-0A	SP7/DP-0A	SP7/ON-0A	SP7/OP-0A
		Plastico Plastic	Si / Yes	SP7/LN-1A	SP7/LP-1A	SP7/DN-1A	SP7/DP-1A	SP7/ON-1A	SP7/OP-1A
Catarifrangente Retro-reflective	4 m	Plastico Plastic	No	SPC/LN-0A	SPC/LP-0A	SPC/DN-0A	SPC/DP-0A	SPC/ON-0A	SPC/OP-0A
		Plastico Plastic	Si / Yes					SPC/ON-0A3X	SPC/OP-0A3X
	Plastico Plastic	No	SPC/LN-1A	SPC/LP-1A	SPC/DN-1A	SPC/DP-1A	SPC/ON-1A	SPC/OP-1A	
	Plastico Plastic	Si / Yes					SPC/ON-1A3X	SPC/OP-1A3X	
Polarizzata Polarized	3 m	Plastico Plastic	No	SPP/LN-0A	SPP/LP-0A	SPP/DN-0A	SPP/DP-0A	SPP/ON-0A	SPP/OP-0A
		Plastico Plastic	Si / Yes					SPP/ON-0A3X	SPP/OP-0A3X
Barriera Through-beam	14 m	Plastico Plastic	Emettitore / Emitter	SPH/00-0A					
			Em. con / With check	SPH/X0-0A					
		Ricev. / Receiv.	SPZ/LN-0A	SPZ/LP-0A	SPZ/DN-0A	SPZ/DP-0A	SPZ/ON-0A	SPZ/OP-0A	
		Ricev.reg / Receiv.reg	SPD/LN-0A	SPD/LP-0A	SPD/DN-0A	SPD/DP-0A	SPD/ON-0A	SPD/OP-0A	
	Metallico Metallic	Emettitore / Emitter	SPH/00-1A						
			Em. con / With check	SPH/X0-1A					
		Ricev. / Receiv.	SPZ/LN-1A	SPZ/LP-1A	SPZ/DN-1A	SPZ/DP-1A	SPZ/ON-1A	SPZ/OP-1A	
		Ricev.reg / Receiv.reg	SPD/LN-1A	SPD/LP-1A	SPD/DN-1A	SPD/DP-1A	SPD/ON-1A	SPD/OP-1A	
	8 m	Plastico Plastic	Emettitore / Emitter	SPU/00-0A					
			Em. con / With check	SPU/X0-0A					
		Ricev. / Receiv.	SPG/AN-0A	SPG/AP-0A	SPG/CN-0A	SPG/CP-0A			
		Ricev. / Receiv.	SPG/AN-0A	SPG/AP-0A	SPG/CN-0A	SPG/CP-0A			
Metallico Metallic	Emettitore / Emitter	SPU/00-1A							
		Em. con / With check	SPU/X0-1A						
	Ricev. / Receiv.	SPG/AN-1A	SPG/AP-1A	SPG/CN-1A	SPG/CP-1A				
	Ricev. / Receiv.	SPG/AN-1A	SPG/AP-1A	SPG/CN-1A	SPG/CP-1A				
3 m	Plastico Plastic	Emettitore / Emitter	SPU/00-0A						
		Em. con / With check	SPU/X0-0A						
	Ricev. / Receiv.	SPV/AN-0A	SPV/AP-0A	SPV/CN-0A	SPV/CP-0A				
	Ricev. / Receiv.	SPV/AN-0A	SPV/AP-0A	SPV/CN-0A	SPV/CP-0A				
Metallico Metallic	Emettitore / Emitter	SPU/00-1A							
		Em. con / With check	SPU/X0-1A						
Ricev.	SPV/AN-1A	SPV/AP-1A	SPV/CN-1A	SPV/CP-1A					

### Specifiche (In accordo con IEC EN 60947-5-2) - Specifications (According to IEC EN 60947-5-2)

#### > Modelli a soppressione di sfondo - Background suppression models

Funzione / Model	SS0/**_**	SS1/**_**	SST/**_**
Regolazione di sensibilità / Sensibility adjustment	No	No	No
Distanza di rilevazione nominale / Nominal sensing distance	50 mm	100 mm	12/25 mm
Emissione / Emission	Rosso / Red (660 nm)		
Diametro Spot Spot diameter	2 mm	4,5 mm	1 mm con / with STF-12 2 mm con / with STF-25
Minimo oggetto rilevabile Minimum detectable object	1 mm	3,5 mm	0,1 mm con / with STF-12 0,25 mm con / with STF-25
Corsa differenziale / Differential travel	≤ 10%		
Ripetibilità / Repeat accuracy	5%		
Tensione alimentazione / Operating voltage	10-30 Vdc		
Ondulazione residua / Ripple	≤ 10%		
Corrente assorbita / Supply current	30 mA		
Corrente di uscita / Load current	100 mA		
Corrente di perdita / Leakage current	10 µA		
Caduta di tensione in uscita / Output voltage drop	1,2 V max. I <sub>L</sub> = 100mA		
Tipo uscita / Output type	NPN o / or PNP - LO/DO selezionabile / selectable		
Frequenza di commutazione / Switching frequency	1 kHz		
Ritardo alla disponibilità / Time delay before availability	200 ms		
Protezione elettriche alimentazione Supply electrical protections	Inversione di polarità, sovratensioni impulsive Polarity reversal, transient		
Protezione elettriche uscita / Protection electrical output	Cortocircuito (autoripristinante) / Short circuit (autoreset)		
Limiti di temperatura operativa / Operative temperature range	-25°C...+70°C (senza condensa / without freeze)		
Deriva termica / Thermal drift	10% Sr		
Interferenza alla luce esterna Interference external light	3000 lux (lampada ad incandescenza / incandescence lamp) 10000 lux (luce solare / sunlight)		
Grado di protezione / Protection degree	IP67 (EN60529) <sup>(1)</sup>		
Indicatori LED / LED indicators	Giallo / Yellow		
Materiale contenitore Housing material	PBT (plastico / plastic) / Ottone nichelato / Nicked plated brass (metallico / metallic) PC (passacavo / cable exit)		
Materiale ottica / Optic material	Plastico / Plastic		
Coppia serraggio / Tightening torque	40 Nm (corpo metallico / metallic housing)		
Peso (appros.) / Weight (approx)	100 g (plastico / plastic), 120 g (metallico / metallic)		

<sup>(1)</sup> Protezione garantita solo con il cavo a connettore correttamente montato / Protection guaranteed only with plug cable well mounted



### > Modelli a riflessione diretta e catarifrangente - Diffuse reflection and retro-reflective models

Funzione / Model	Riflessione Diretta / Diffuse reflection					Catarifrangente Retro-reflective	Polarizzata Polarized
	S*2/**-**	S*3/**-**	S*6/**-**	S*7/**-**	S*9/**-**	S*C/**-****	S*8/**-****
Regolazione della sensibilità Sensitivity adjustment	No	Si / Yes	No	Si / Yes	No	No	Si / Yes
Distanza di rilevazione nominale Nominal sensing distance	100 mm con target bianco with white target 100x100 mm		400 mm con target bianco with white target 200x200 mm		800 mm con target bianco / with white target 400x400 mm	4 m con riflettore with reflector RL 110	3 m con riflettore with reflector RL 110
Emissione Emission	Infrarosso Infrared (880 nm)						Rosso Red (660 nm)
Corsa differenziale Differential travel	≤ 10%						
Ripetibilità / Repeat accuracy	5%						
Tensione di alimentazione Operating voltage	10-30 Vdc						
Ondulazione residua Ripple	≤ 10%						
Corrente assorbita Supply current	30 mA						
Corrente di uscita Load current	100 mA						
Corrente di perdita Leakage current	10 µA						
Caduta di tensione in uscita Output voltage drop	1,2 V max. IL = 100mA						
Tipo uscita / Output type	NPN o / or PNP - LO/DO selezionabile / selectable						
Frequenza di commutazione Switching frequency	250 Hz						
Ritardo alla disponibilità Time delay before availability	200 ms						
Protezioni elettriche alimentazione Supply electrical protections	Inversione di polarità, sovratensioni impulsive Polarity reversal, transient						
Protezioni elettriche uscita Protection electrical output	Cortocircuito (autopristinante) Short circuit (autoreset)						
Limiti di temperatura Operative temperature range	-25°C...+70°C (senza condensa / without freeze)						
Deriva termica / Thermal drift	10% Sr						
Inteferenza alla luce esterna Interference external light	3000 lux (lampada ad incandescenza / incandescence lamp) 10000 lux (luce solare / sunlight)						
Grado di protezione / Protection degree	IP67 (EN60529) <sup>(1)</sup>						
Indicatori LED / LED indicators	Giallo / Yellow						
Materiale contenitore Housing material	PBT (plastico / plastic) / Ottone nichelato / Nicked plated brass (metallico / metallic) PC (passacavo / cable exit)						
Materiale ottica / Optic material	Plastico / Plastic						
Coppia serraggio / Tightening torque	40 Nm (corpo metallico / metal housing)						
Peso (appross.) / Weight (approx)	100 g (plastico / plastic), 120 g (metallico / metallic)						

<sup>(1)</sup> Protezione garantita solo con il cavo a connettore correttamente montato / Protection guaranteed only with plug cable well mounted

## SS-SP series - CYLINDRICAL PHOTOELECTRIC SENSORS

### > Modelli a barriera - Through beam models

Funzione / Model	Barriera standard Standard beam			Barriera per piccoli e piccolissimi oggetti Barrier for small and ultra-small objects		
	Emettitore Emitter	Ricevitore Receiver	Ricevitore Receiver	Emettitore Emitter	Ricevitore Receiver	Ricevitore Receiver
	S*H/*0-**	S*Z/***_**	S*D/***_**	S*U/*0-**	S*G/***_**	S*V/***_**
Regolazione della sensibilità / Sensibility adjustment		Si / Yes	No		No	No
Distanza di rilevazione nominale Nominal sensing distance	14 m				8 m	3 m
Oggetto minimo rilevabile Minimum detectable object					ø4 mm	ø1 mm
Emissione / Emission	Rosso / Red (660 nm)					
Tolleranza / Tolerance	90%-200% @ Eg = 1,5					
Corsa differenziale / Differential travel	≤ 10%					
Ripetibilità / Repeat accuracy	5%					
Tensione di alimentazione / Operating voltage	10-30 Vdc					
Ondulazione residua / Ripple	≤ 10%					
Corrente assorbita / Supply current	40 mA	30 mA		25 mA	20 mA	
Corrente di uscita / Load current	100 mA			100 mA		
Corrente di perdita / Leakage current	10 µA					
Caduta di tensione in uscita / Output voltage drop	1,2 V max. IL = 100mA					
Tipo uscita / Output type	NPN o / or PNP - LO/DO selezionabile /selectable			NPN o / or PNP - NO o / or NC		
Frequenza di commutazione Switching frequency	250 Hz			250 Hz		
Ritardo alla disponibilità Time delay before availability	200 ms			200 ms		
Protezioni elettriche alimentazione Supply electrical protections	Inversione di polarità, sovratensioni impulsive Polarity reversal, transient					
Protezioni elettriche uscita Protection electrical output	Cortocircuito (autopristinante) Short circuit (autoreset)					
Limiti di temperatura / Operative temperature range	-25°C ..+70°C (senza condensa)					
Deriva termica / Thermal drift	10% Sr			≤ 10% Sr		
Inteferenza alla luce esterna Interference external light	3000 lux (lampada ad incandescenza / incandescence lamp) 10000 lux (luce solare / sunligh)					
Grado di protezione / Protection degree	IP67 (EN 60529) <sup>(1)</sup>					
Indicatori LED / LED indicators	Giallo / Yellow			Rosso (uscita attivata) / Red (activated output)		
Materiale contenitore Housing material	PBT (plastico / plastic) / Ottone nichelato / Nicked plated brass (metallico / metallic) PC (passacavo / cable exit)					
Materiale ottica / Optic material	Plastico / Plastic					
Coppia serraggio / Tightening torque	40 Nm (corpo metallico / metal housing)					
Peso (appross.) / Weight (approx)	200 g (plastico / plastic), 240 g (metallico / metallic)					

<sup>(1)</sup> Protezione garantita solo con il cavo a connettore correttamente montato / Protection guaranteed only with plug cable well mounted

### Schemi elettrici delle connessioni - Electrical diagrams of the connections

S\*\*/0N-\*\*

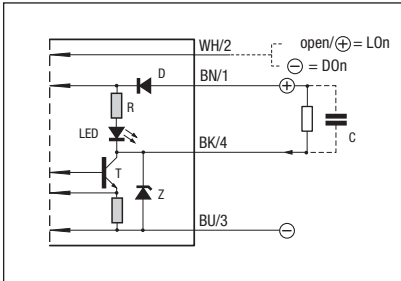

S\*\*/0P-\*\*

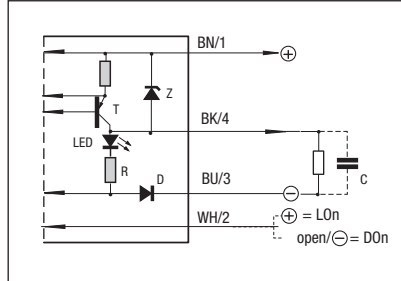

S\*\*/\*N-\*\* (3 fili NPN / 3 wires NPN)

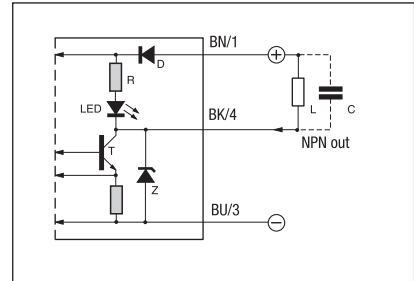

S\*\*/\*P-\*\* (3 fili PNP / 3 wires PNP)

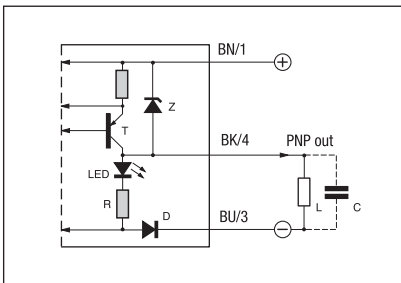

S\*\*/00-\*\*

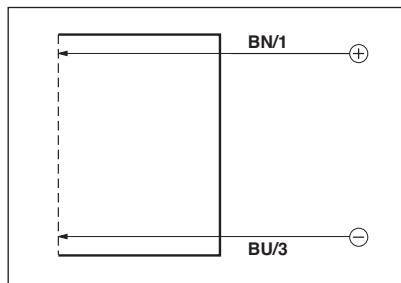

S\*H/X0-\*\*

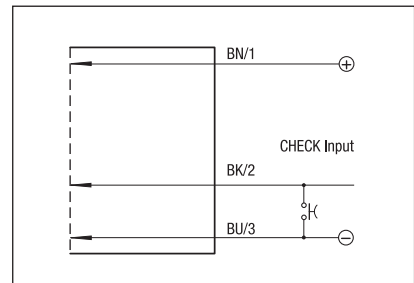

S\*U/X0-\*\*

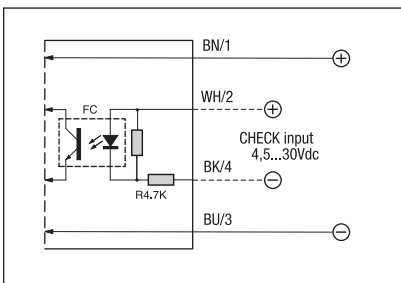

#### Legenda Key

- BN → marrone/brown
- BK → nero/black
- PK → rosa/pink
- BU → blu/blue
- WH → bianco/white
- GY → grigio/gray

### Connettore - Plug

M12 Tasteggio diretto / Diffuse reflection  
Polarizzata / Polarized  
Ricevitore / Receiver  
Soppr. di sfondo / Background suppr.

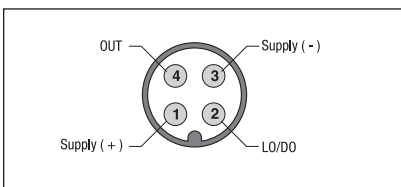

M12 Emittitore senza check  
Emitter without check

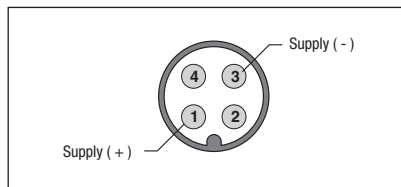

M12 Emittitore con check S\*H/X0-\*E  
Emitter with check S\*H/X0-\*E

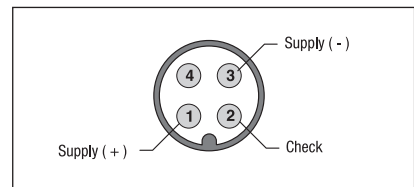

M12 M12 Emittitore con check S\*U/X0-\*\*  
Emitter with check S\*U/X0-\*\*

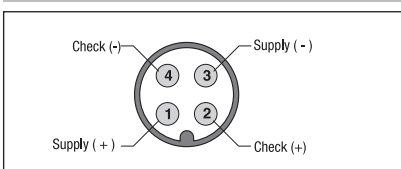

### Curva di risposta - Response diagram

SS0/\*\*\_\*\*

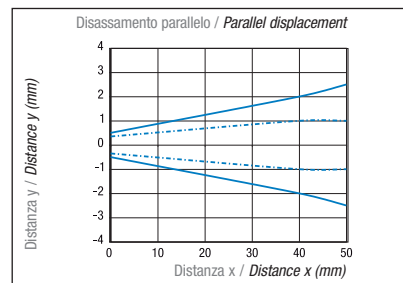
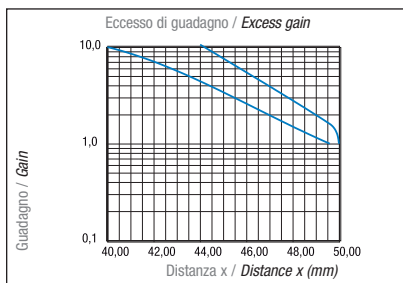
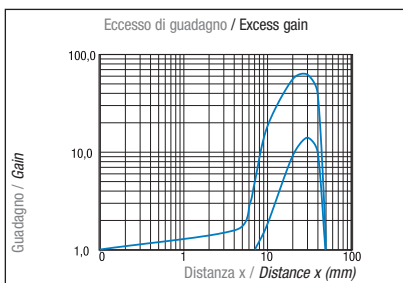

SS1/\*\*\_\*\*

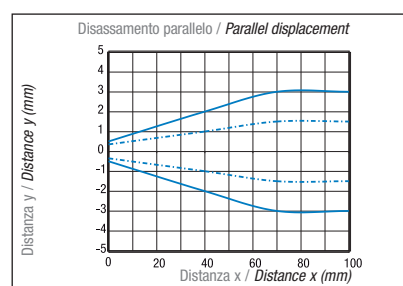
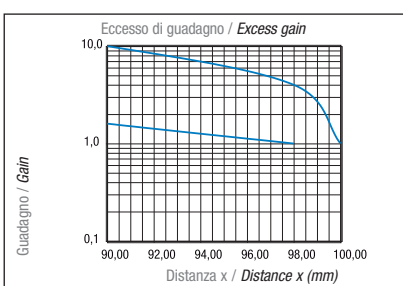
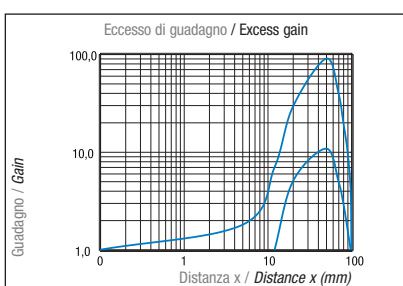

SST/\*\*\_\*\* + STF-12

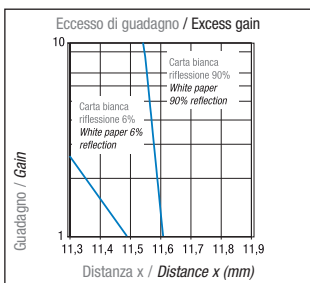
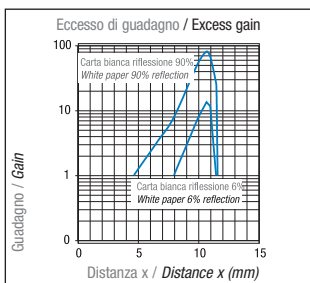

SST/\*\*\_\*\* + STF-25

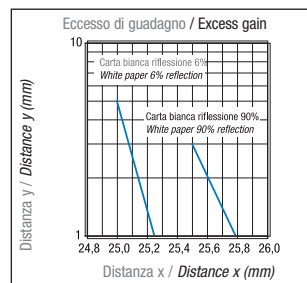
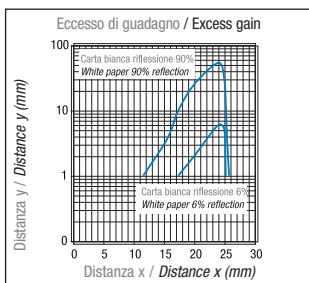

S\*2/\*\*\_\*\* S\*3/\*\*\_\*\*

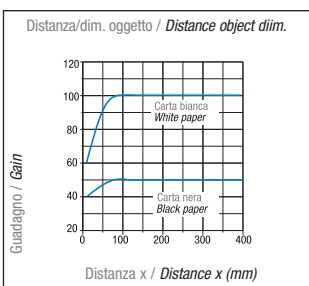
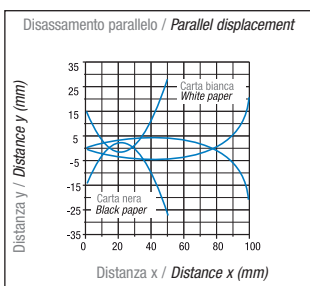
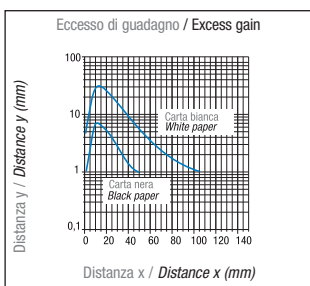

S\*7/\*\*\_\*\*

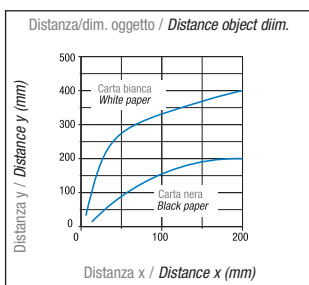
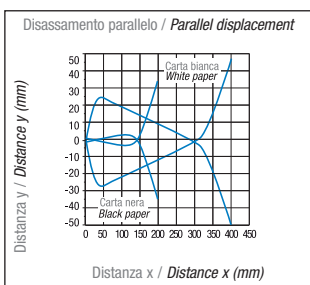
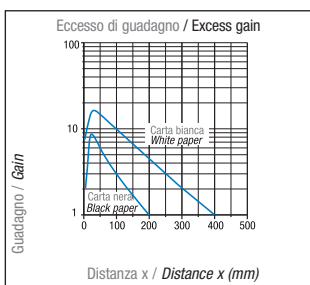

S\*8/\*\*\_\*\*

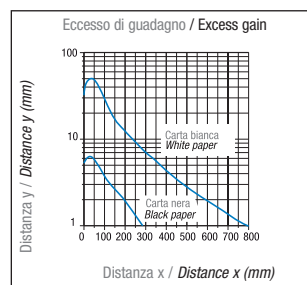

S\*8/\*\*\_\*\*

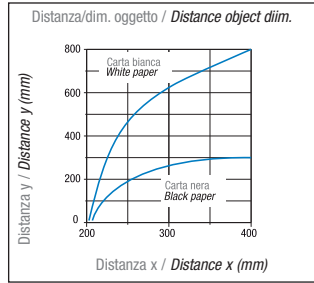
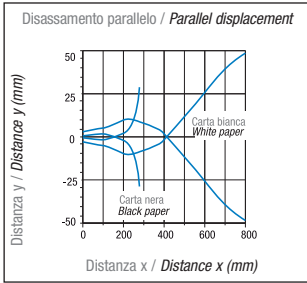

S\*C/\*\*\_\*\*\*\*

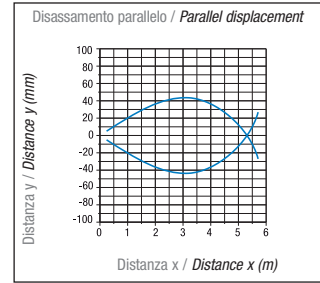
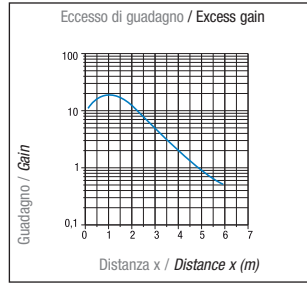

S\*P/\*\*\_\*\*\*\*

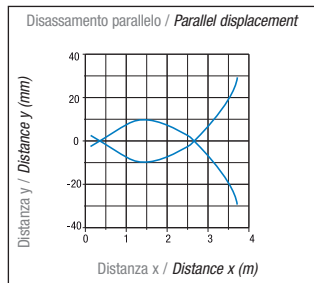
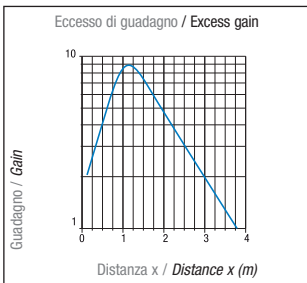

S\*H/\*\*\_\*\* + S\*D/\*\*\_\*\* S\*H/\*\*\_\*\* + S\*Z/\*\*\_\*\*

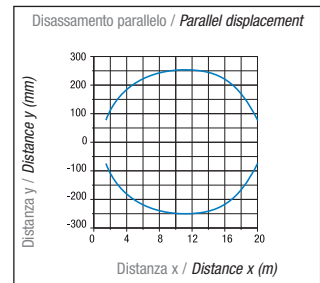
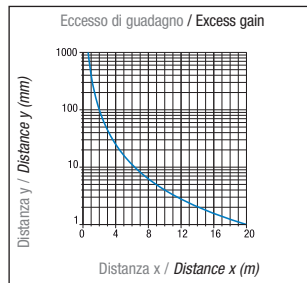

S\*H/\*\*\_\*\* + S\*D/\*\*\_\*\* S\*H/\*\*\_\*\* + S\*Z/\*\*\_\*\*

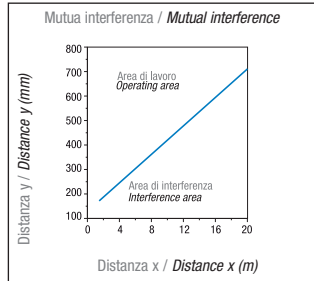
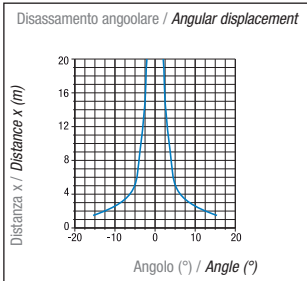

S\*U/\*\*\_\*\* + S\*G/\*\*\_\*\*

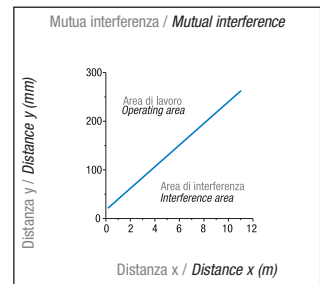
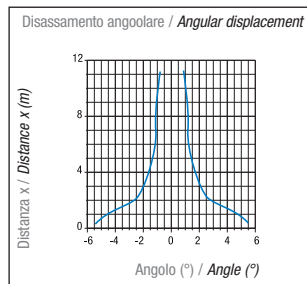
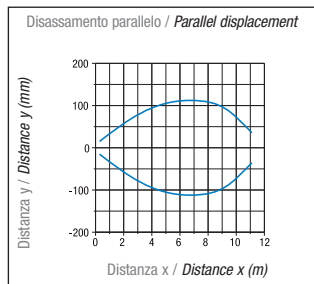
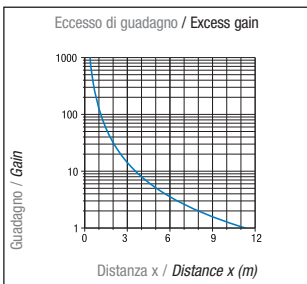

S\*U/\*\*\_\*\* + S\*V/\*\*\_\*\*

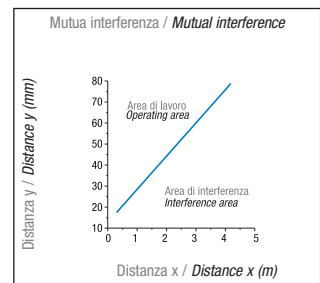
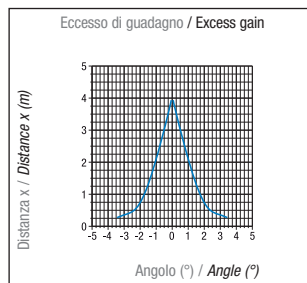
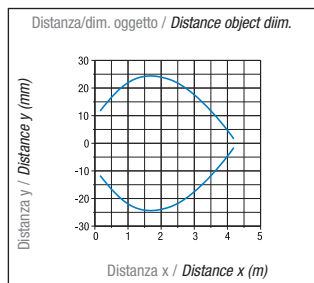
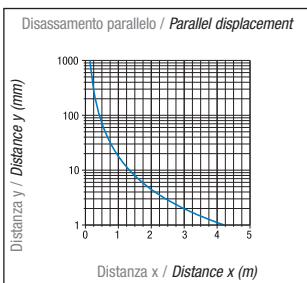

### Dimensioni - Dimensions

#### Uscita a cavo / Cable exit

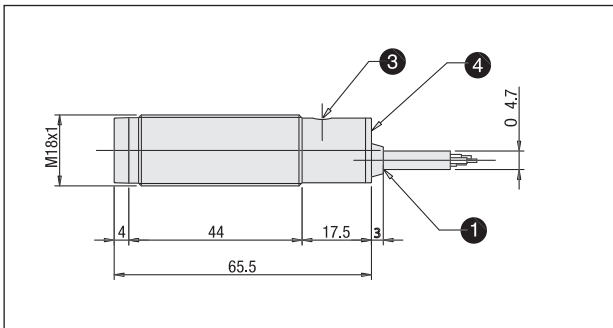

#### Uscita a connettore M12 / M12 plug cable exit

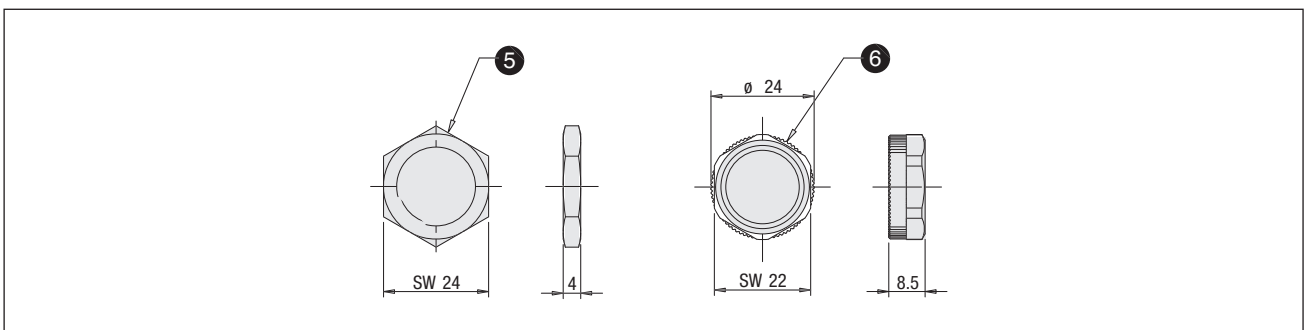
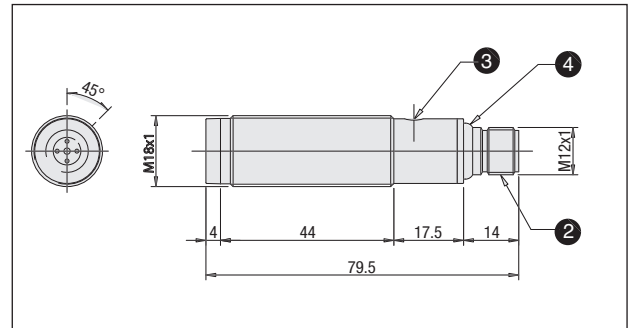

#### Legenda / Key

- |   |  |
|---|--|
| ① Uscita a cavo assiale<br><i>Axial cable exit</i>    | ⑤ Ghiera metallica<br><i>Metal tightening nut</i>  |
| ② Uscita connettore M12<br><i>M12 plug cable exit</i> | ⑥ Ghiera plastica<br><i>Plastic tightening nut</i> |
| ③ Trimmer<br><i>Trimmer</i>                           |  |
| ④ Led<br><i>Led</i>                                   |  |

Connettori serie CD - Accessori serie ST / *Plugs CD series - Accessories ST series*

### Uscita a cavo / Cable exit

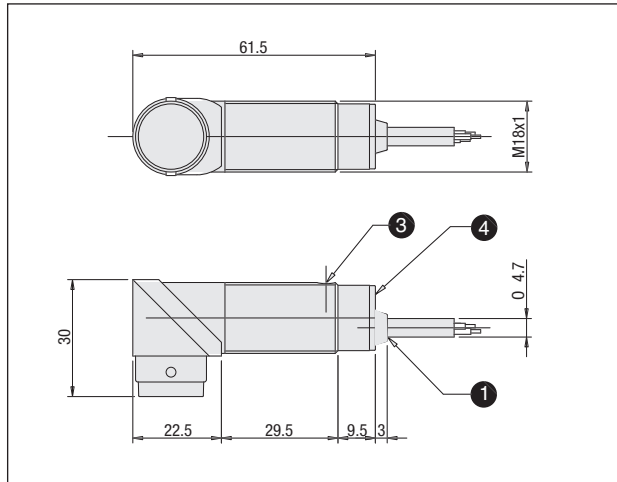

### Uscita a connettore M12 / M12 plug cable exit

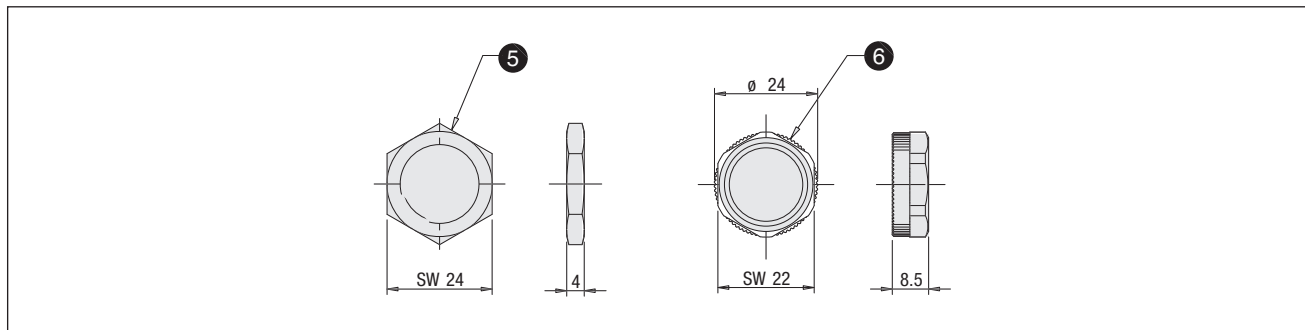
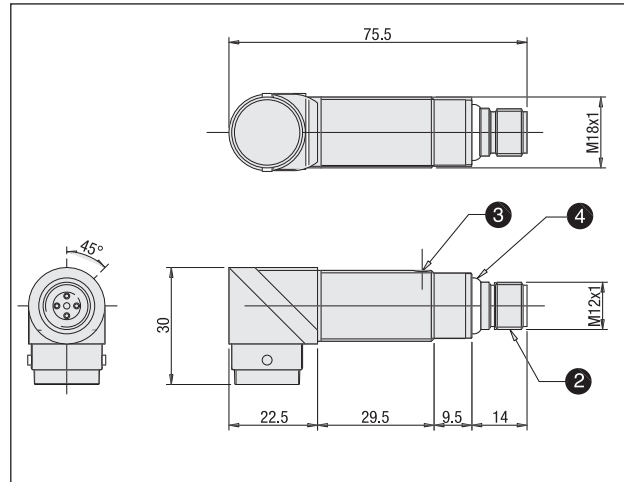

### Legenda / Key

- |   |  |
|---|--|
| ① Uscita a cavo assiale<br><i>Axial cable exit</i>    | ⑤ Ghiera metallica<br><i>Metal tightening nut</i>  |
| ② Uscita connettore M12<br><i>M12 plug cable exit</i> | ⑥ Ghiera plastica<br><i>Plastic tightening nut</i> |
| ③ Trimmer<br><i>Trimmer</i>                           |  |
| ④ LED<br><i>LED</i>                                   |  |

Connettori serie CD - Accessori serie ST / Plugs CD series - Accessories ST series