



## THREADED GLOBE VALVE IN CAST IRON - STROKE 16,5 mm

VFS

### APPLICATION

VFS valve bodies are used in HVAC systems to control and fluids in heating, cooling, refrigeration, ventilation in civil and industrial plants. Valves are female threaded for connections. 3-way valves are used as mixing. They can also be used as diverting by reducing the max differential pressure value by 50%. Do not use the bypass (angle way) as control port. VFS valve bodies are motorized by SE6 series electric actuators.

### WORKING

Stem up: direct way A-AB closed (B-AB way open for 3-way valve)  
 Stem down: direct way A-AB open (B-AB way closed for 3-way valve)

TYPE		CONNECTION	KV <sub>s</sub> m <sup>3</sup> /h	MAX DIFF. PRESS. * bar
2-WAY	3-WAY			
VFS215	VFS315	DN15 (G 1/2)	2.5	2.2 (11.0)
VFS218	VFS318	DN20 (G 3/4)	4.0	2.2 (11.0)
VFS220	VFS320	DN20 (G 3/4)	6.3	2.2 (11.0)
VFS225	VFS325	DN25 (G 1)	10.0	2.2 (7.0)
VFS232	VFS332	DN32 (G 1 1/4)	16.0	2.2 (4.4)
VFS240	VFS340	DN40 (G 1 1/2)	25.0	2.2 (2.7)
VFS250	VFS350	DN50 (G 2)	40.0	2.2 (2.2)
VFS252	VFS352	DN50 (G 2)	30.0	2.2 (2.2)

\*dP<sub>max</sub> The values in brackets are the max differential pressure when valve is fully closed. The servomotor can open and close the valve with safety. The values out of the brackets are the suggested max pressure drop (valve fully open).

### TECHNICAL DATA

**Nominal pressure:** PN16 (ISO7268/EN1333)  
**Connections:** female threaded GAS  
**Valve body:** cast-iron G25  
**Plug:** brass OT58  
**Stem:** stainless steel AISI304  
**Stem packing nut:** brass OT58  
**Spring:** stainless steel AISI304  
**Stem packing:** FKM O-ring  
**Stroke lenght:** 16.5 mm

**Control flow characteristic:** direct way A→AB equal-percentage  
 angle way B→AB linear  
**Leakage:** direct way A→AB perfect sealing  
 angle way B→AB max 0,2% KV<sub>s</sub>  
 50:1  
**Rangeability:**  
**Fluid temperature:** -10...+130°C  
**Fluid type:** water  
 water with max 50% glycol  
 saturated steam max 2,5 Ata  
**Dimensions:** see relevant table  
**Weight:** see relevant table



**INSTALLATION**

**PIPING CONNECTIONS**

Make the piping connections according to flow directions indicated on valve body as the following drawings.

AB is always the output. Input is A for 2-way valve, A and B for 3-way valve.

2-way valve

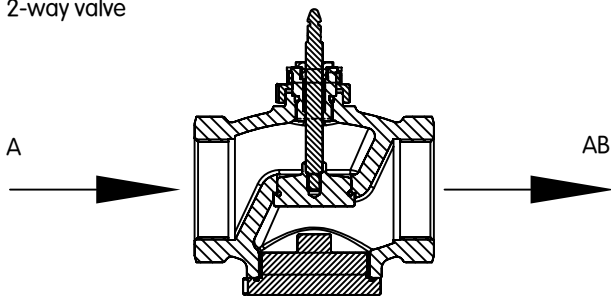

3-way valve

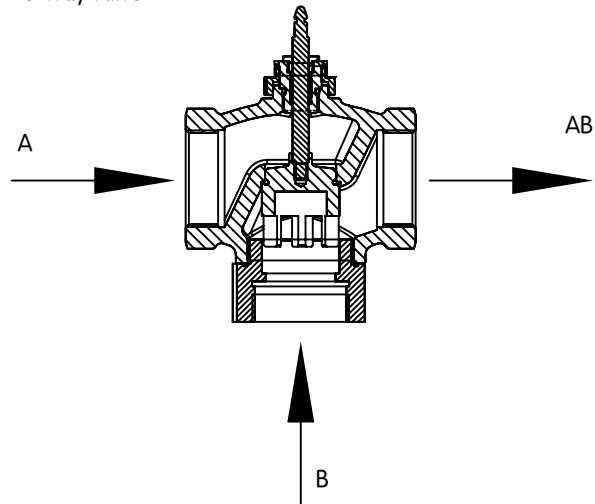

**VALVE MOUNTING**

Before mounting the valve body be sure that the pipes are clean and free of soldering scraps. Pipes must be lined up squarely with the valve at each connection and free of vibrations. Install the valve/actuator vertically or horizontally but never upside down. Leave enough clearance to facilitate the dismounting of actuator from the valve body for maintenance purpose.

The valve must not be installed in explosive atmosphere or in ambient

with temperature and humidity outside the ranges indicated on technical features part. Valve must not be subjected to water or steam jets or dripping liquid. 3-way valve must be used in mixing way fig.2 (2 inlets 1 output). If the valve is used in diverting way (fig.3, 1 inlet 2 outputs), the max differential pressure allowed is reduced by 50%.

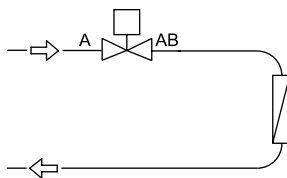

fig.1  
2-way

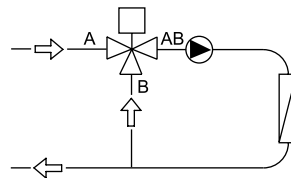

fig.2  
3-way mixing used in mixing application toward user

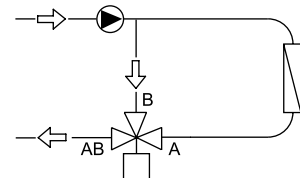
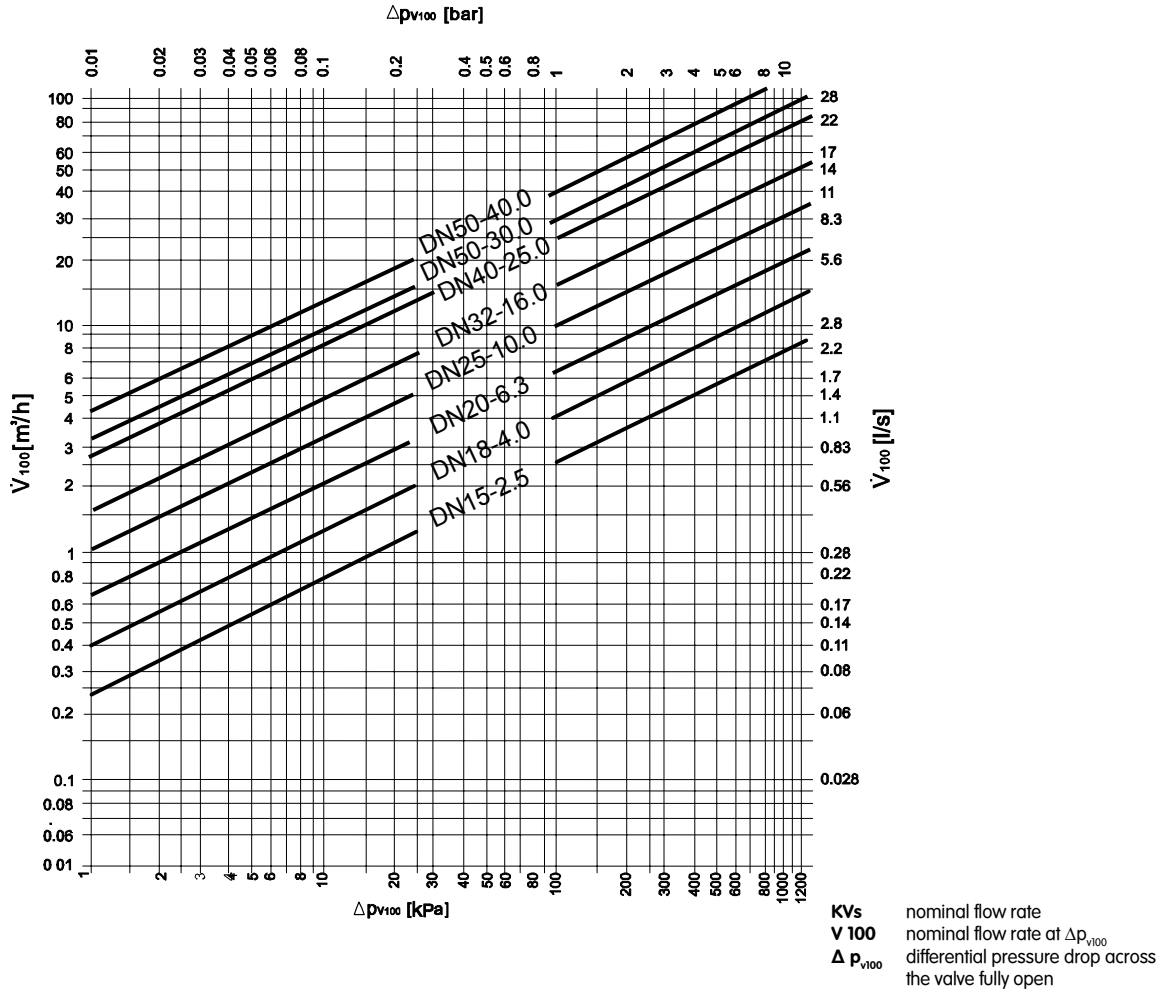

fig.3  
3-way mixing used in diverting application toward user

# THREADED GLOBE VALVE BODIES - STROKE 16,5 mm

VFS

## CONTROL DROP DIAGRAM



## CONTROL FLOW CHARACTERISTICS

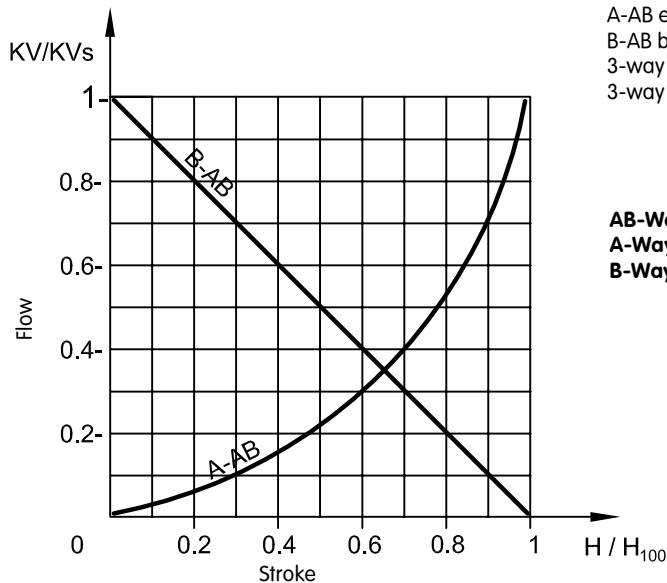

A-AB equal-percentage way  
 B-AB bypass linear way  
 3-way used as mixing inlet in A and B, outlet AB  
 3-way used as diverting inlet in AB, outlet from A and B

**AB-Way** constant flow  
**A-Way** variable flow  
**B-Way (bypass)** variable flow



# THREADED GLOBE VALVE BODIES - STROKE 16,5 mm

VFS

## PRESSURE / TEMPERATURE DIAGRAM

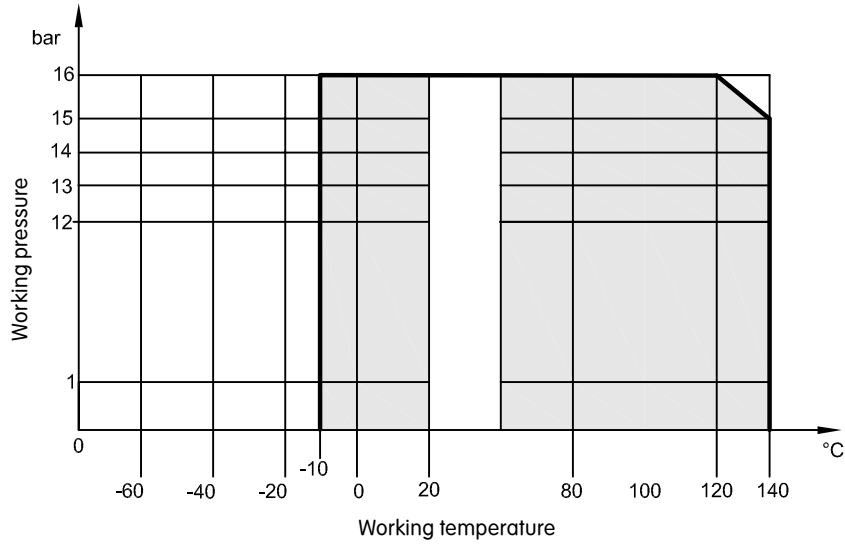

## OVERALL DIMENSIONS (mm)

G	A	B	C	C1	D	H min.	Weight (g)	
			VFS3	VFS2			VFS2	VFS3
G 1/2	66	87.0	45.5	32.5	33.0	300	650	800
G 3/4	90	85.5	53.5	42.0	45.0	305	1100	1250
G 1	96	93.0	56.5	42.5	48.0	310	1450	1650
G 1 1/4	109	96.0	60.4	47.5	54.5	315	1950	2200
G 1 1/2	122	100.5	64.5	55.0	61.0	320	2750	2950
G 2	196	113.5	95.0	71.0	98.0	335	3950	4250

