



Self Priming Centrifugal Pump

Classic T Series
Model T4A3-B
Size 4" x 4"

T SERIES
Classic

PUMP SPECIFICATIONS

Size: 4" x 4" (101 mm x 101 mm) NPT - Female.

Casing: Gray Iron 30.

Maximum Operating Pressure 86 psi (593 kPa).*

Semi-Open Type, Two Vane Impeller: Ductile Iron 65-45-12.

Handles 3" (76,2 mm) Diameter Spherical Solids.

Impeller Shaft: Alloy Steel 4150.

Shaft Sleeve: Alloy Steel 4130.

Replaceable Wear Plate: Carbon Steel 1015.

Removable Cover Plate: Gray Iron 30; 37 lbs. (17 kg).

Bearing Housing: Gray Iron 30.

Seal Plate: Gray Iron 30.

Flap Valve: Neoprene ^w/Steel Reinforcing.

Radial Bearing: Open Single Row Ball.

Thrust Bearing: Open Double Row Ball.

Bearing and Seal Cavity Lubrication: SAE 30 Non-Detergent Oil.

Flanges: 125# Gray Iron 30.

Gaskets: Buna-N ^w/Compressed Synthetic Fibers, Vegetable Fiber, PTFE, Cork and Rubber.

O-Rings: Buna-N.

Hardware: Standard Plated Steel.

Brass Pressure Relief Valve.

Bearing Cavity Oil Level Sight Gauge.

Optional Equipment: Stainless Steel 316 Pressure Relief Valve.

Automatic Air Release Valve. G-R Hard Iron Impeller, Seal Plate and Wear Plate. 120V/240V Casing Heater. High Pump Temperature Shutdown Kit. Self-Cleaning Wear Plate.

Gray Iron 30 Suction and Discharge Spool Flanges:

4" ASA (**Specify Model T4A3-B /F**).

100 mm DIN 2527 (PN 16) (**Specify Model T4A3-B /FM**).

**Consult Factory for Applications Exceeding Maximum Pressure and/or Temperature Indicated.*



Shown with Optional Suction & Discharge Spool Flanges (Available in ASA or DIN Standard Sizes).

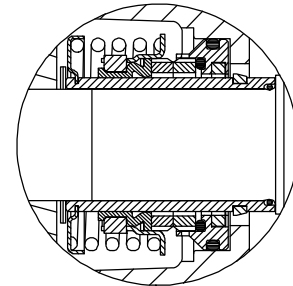
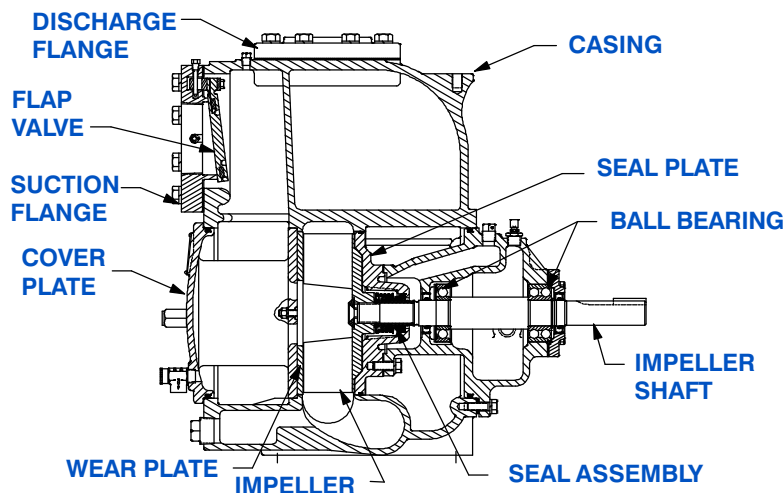

SEAL DETAIL

Cartridge Type, Mechanical, Oil-Lubricated, Double Floating, Self-Aligning. Tungsten Titanium Carbide Rotating and Stationary Faces. Stainless Steel 316 Stationary Seat. Fluorocarbon Elastomers (DuPont Viton[®] or Equivalent). Stainless Steel 18-8 Cage and Spring. Maximum Temperature of Liquid Pumped, 160°F (71°C).*



GORMAN-RUPP PUMPS

www.grpumps.com

Specifications Subject to Change Without Notice

Printed in U.S.A.

Specification Data

SECTION 55, PAGE 1100

APPROXIMATE DIMENSIONS and WEIGHTS

NET WEIGHT: 575 LBS. (261 KG.)*
SHIPPING WEIGHT: 614 LBS. (279 KG.)*
EXPORT CRATE: 22.7 CU. FT. (0,64 CU. M.)
***ADD 15 LBS. (6,8 KG.) W/EACH SPOOL FLANGE**

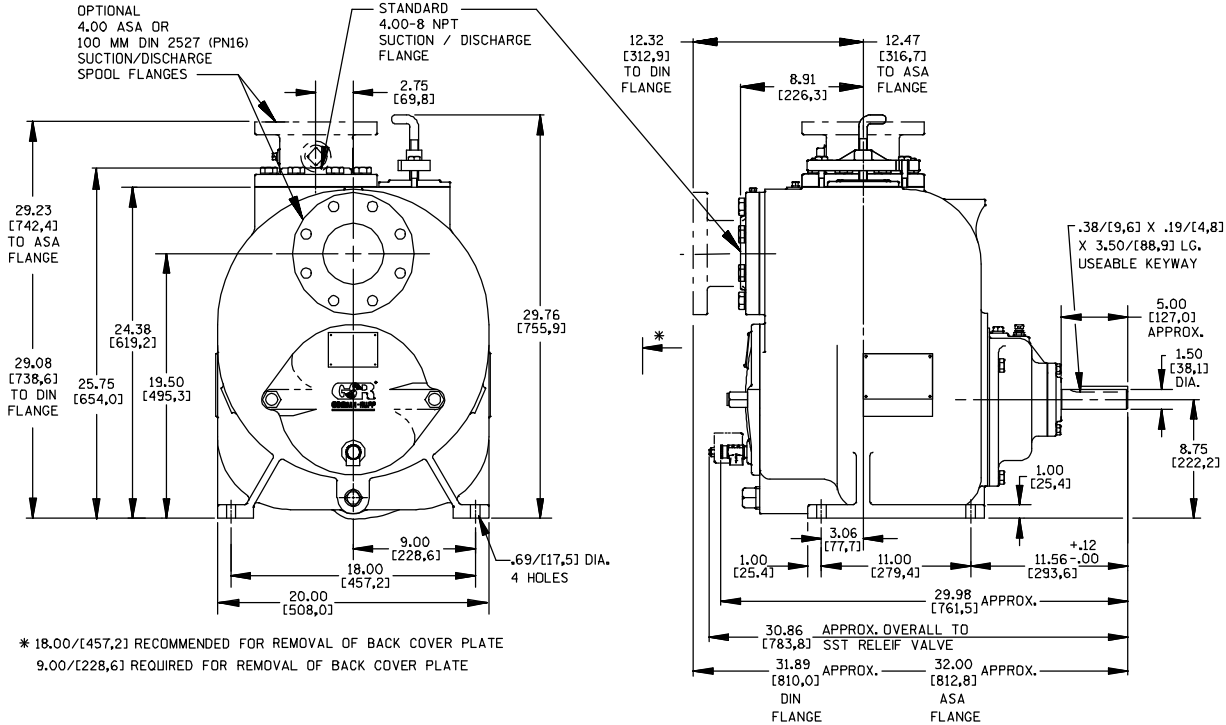

OPTIONAL ASA OR DIN STANDARD SUCTION & DISCHARGE SPOOL FLANGES AVAILABLE

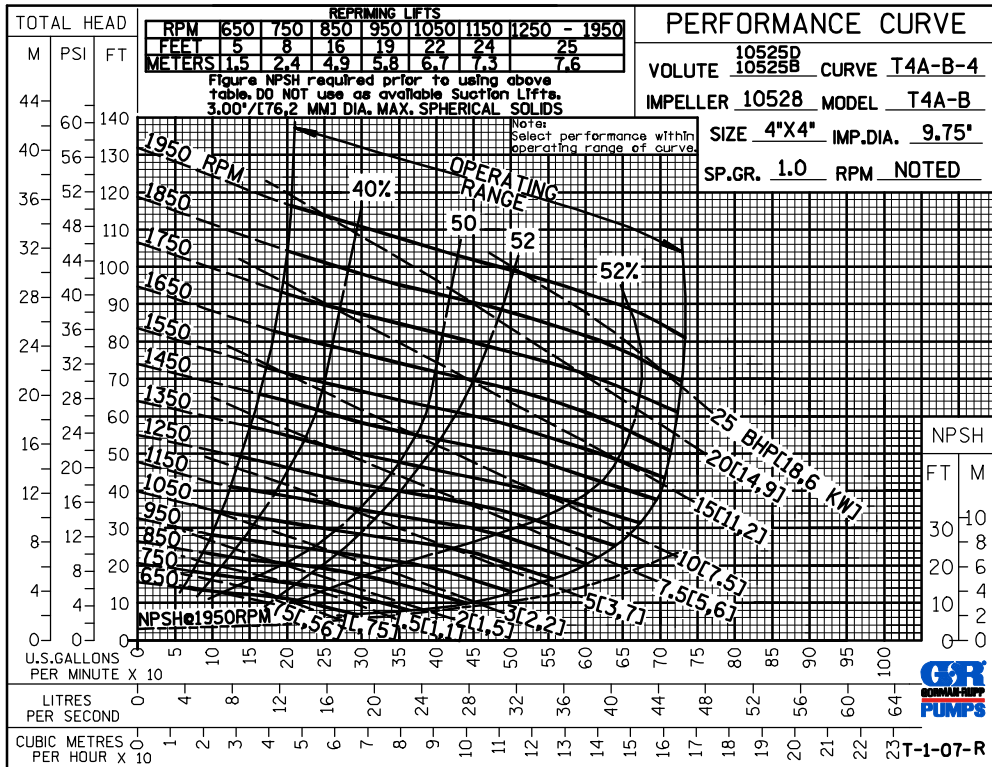

GORMAN-RUPP PUMPS

www.grpumps.com

Specifications Subject to Change Without Notice

Printed in U.S.A.

CDS

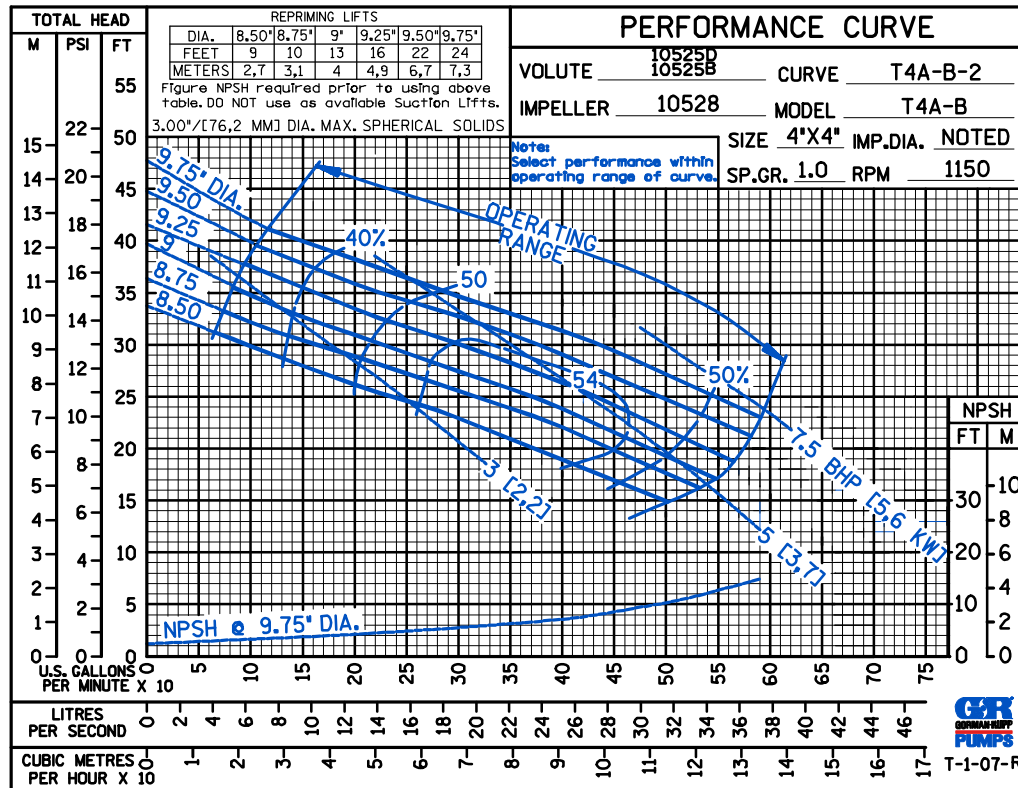
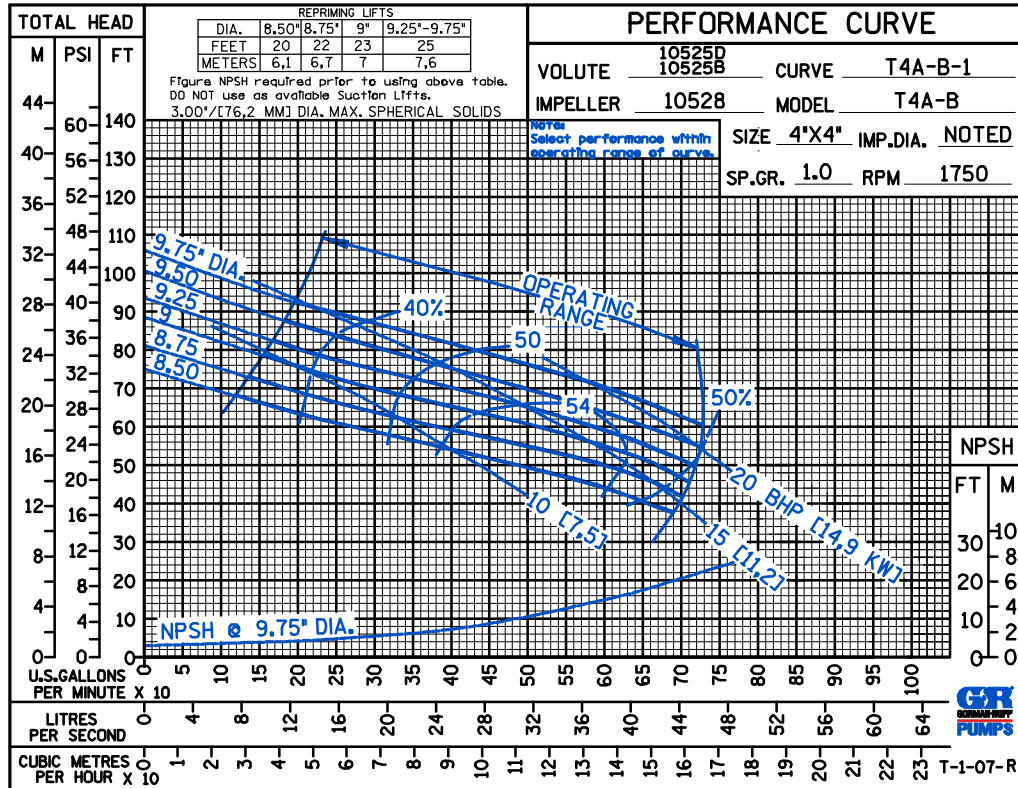

THE GORMAN-RUPP COMPANY • MANSFIELD, OHIO

GORMAN-RUPP OF CANADA LIMITED • ST. THOMAS, ONTARIO, CANADA

Specifications Subject to Change Without Notice

Printed in U.S.A.

CDS

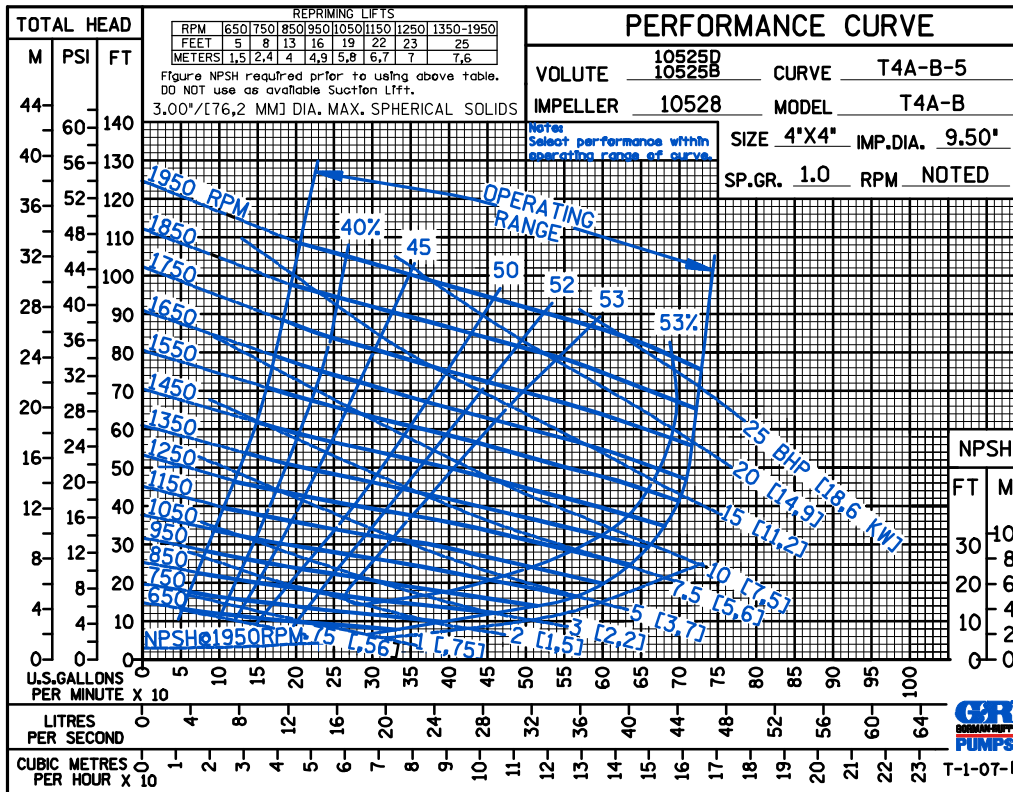
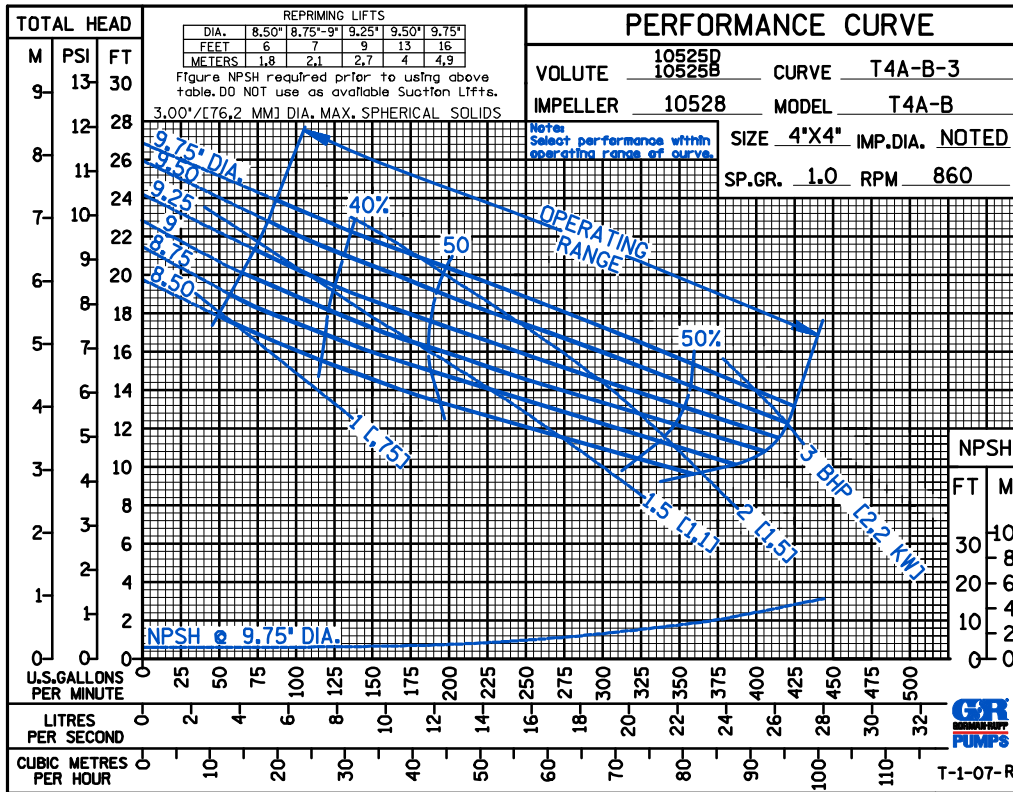

THE GORMAN-RUPP COMPANY • MANSFIELD, OHIO

GORMAN-RUPP OF CANADA LIMITED • ST. THOMAS, ONTARIO, CANADA

Specifications Subject to Change Without Notice

Printed in U.S.A.

CDS

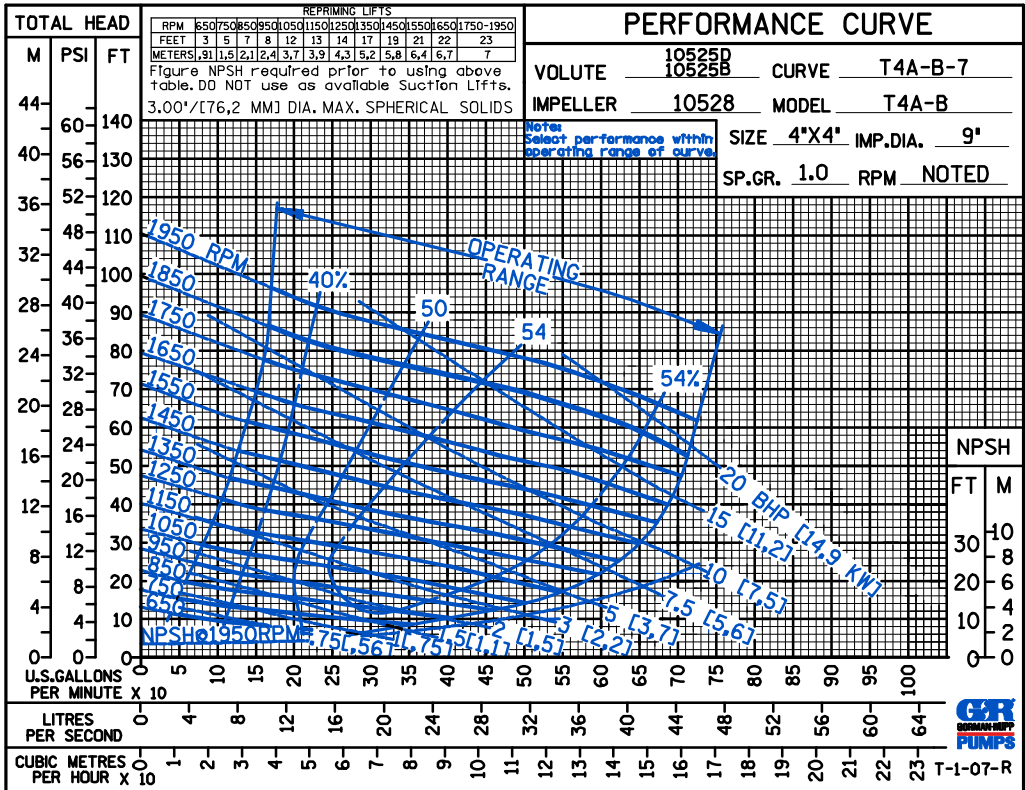
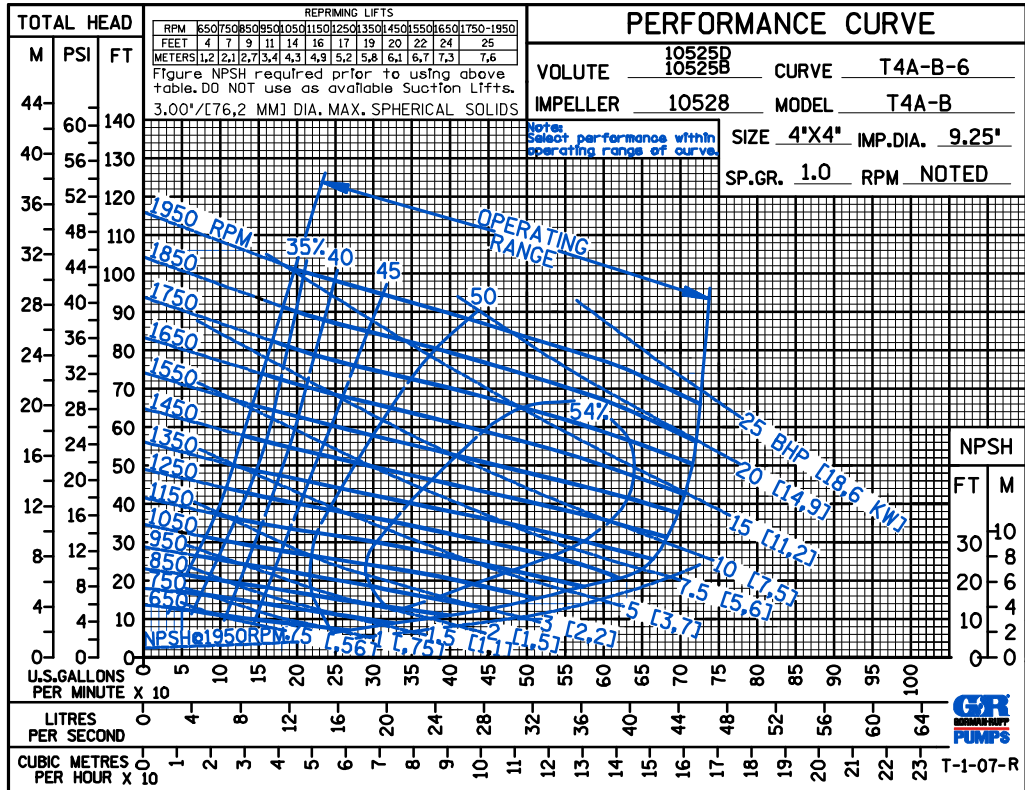

THE GORMAN-RUPP COMPANY • MANSFIELD, OHIO

GORMAN-RUPP OF CANADA LIMITED • ST. THOMAS, ONTARIO, CANADA

Specifications Subject to Change Without Notice

Printed in U.S.A.

CDS

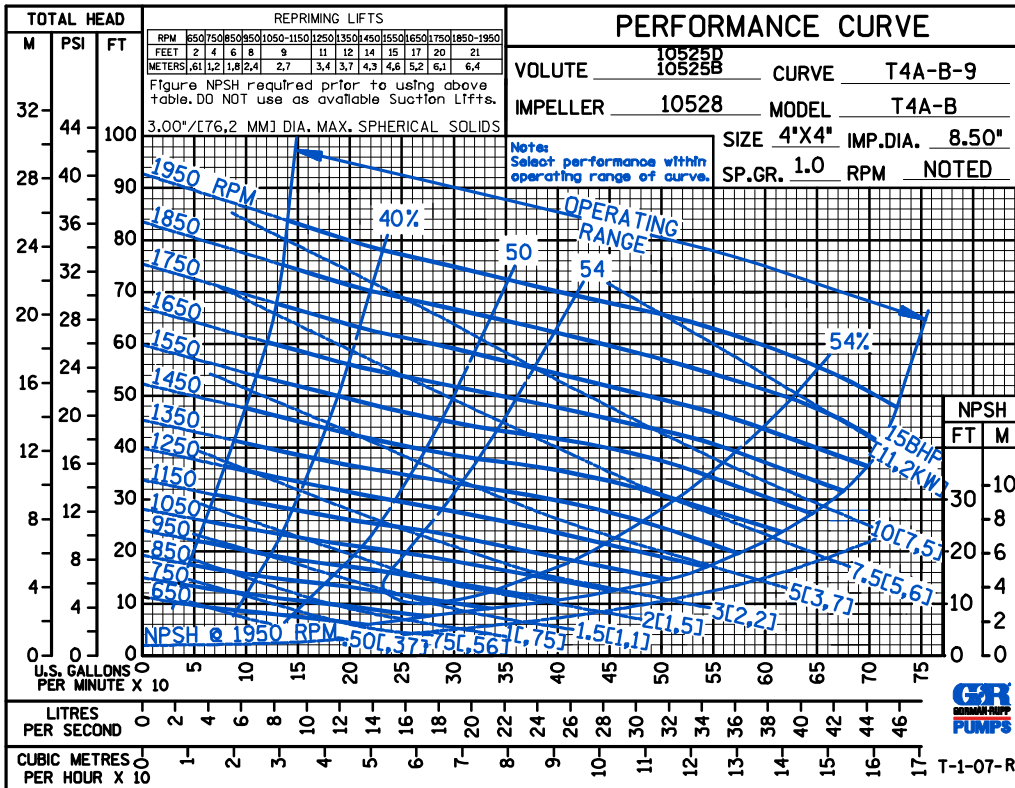
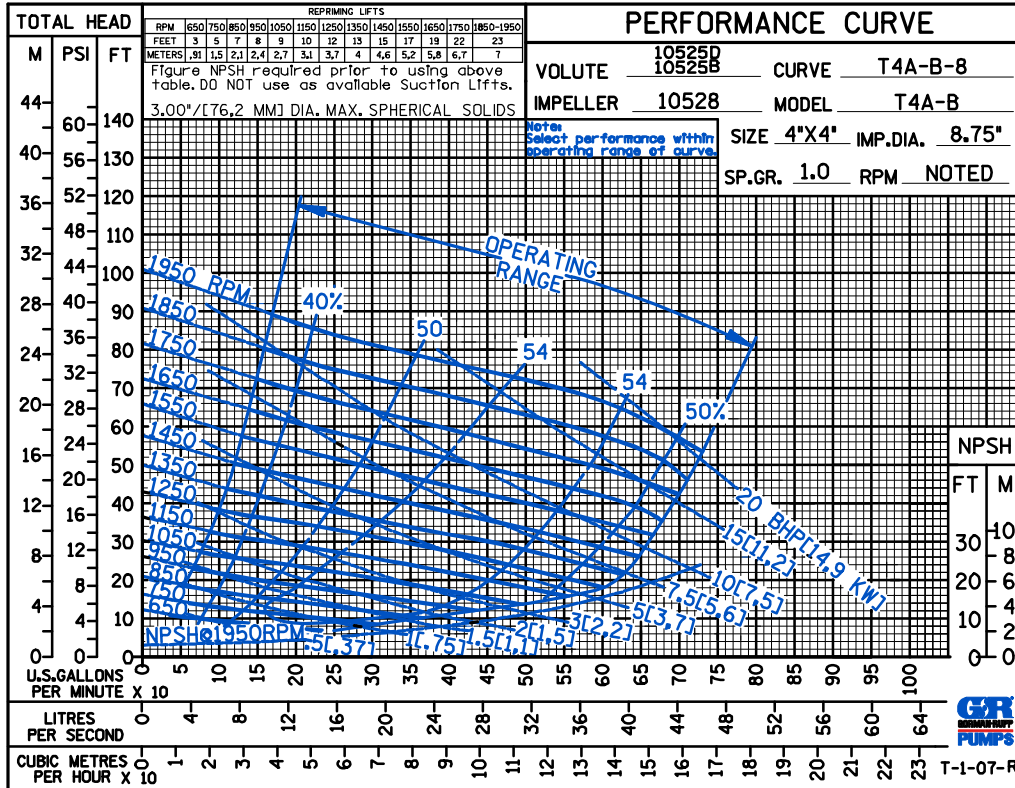

THE GORMAN-RUPP COMPANY • MANSFIELD, OHIO

GORMAN-RUPP OF CANADA LIMITED • ST. THOMAS, ONTARIO, CANADA

Specifications Subject to Change Without Notice

Printed in U.S.A.

CDS

50 HERTZ

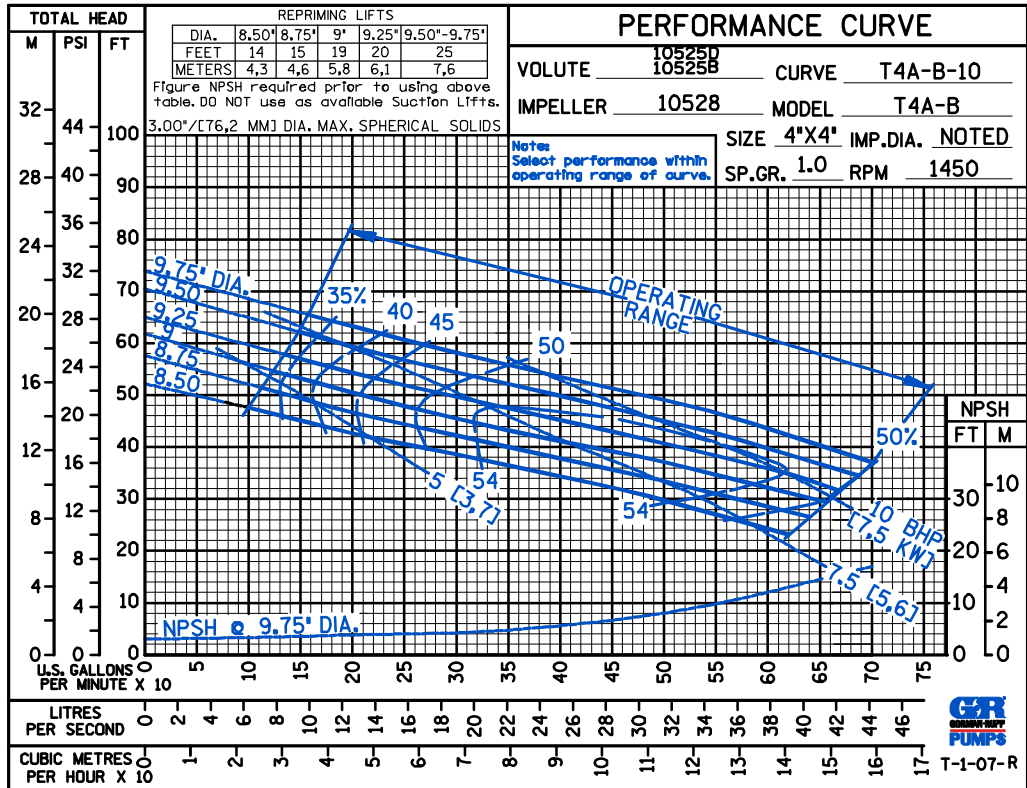

50 HERTZ

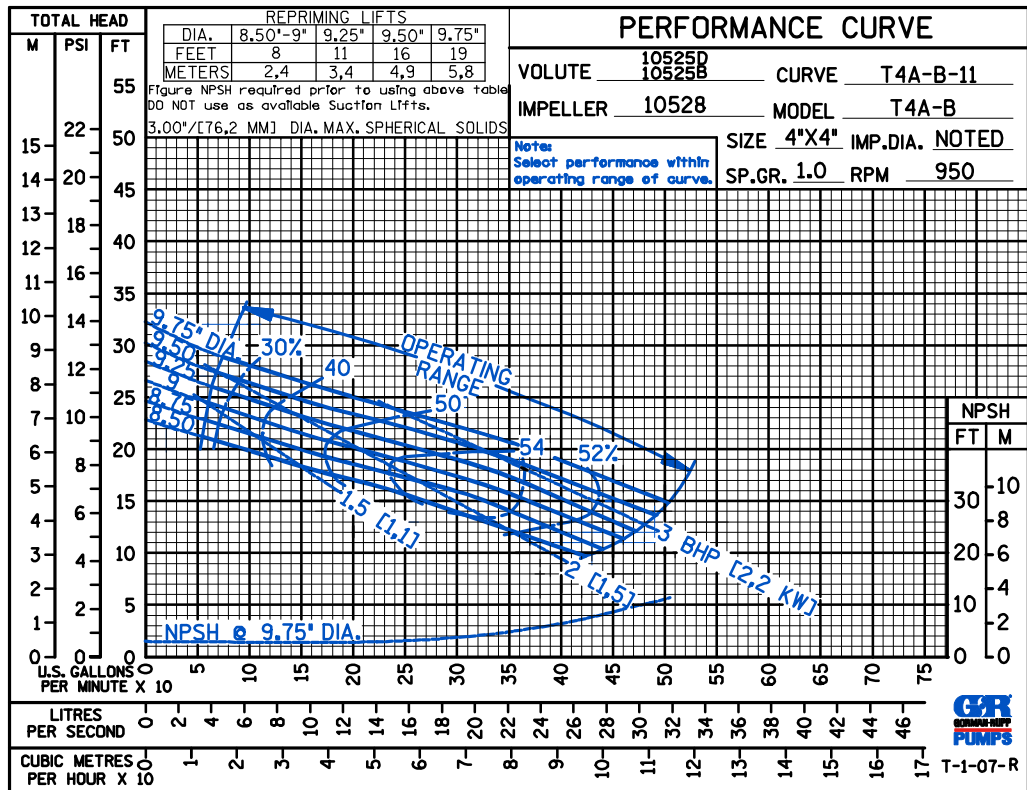

THE GORMAN-RUPP COMPANY • MANSFIELD, OHIO

GORMAN-RUPP OF CANADA LIMITED • ST. THOMAS, ONTARIO, CANADA

Specifications Subject to Change Without Notice

Printed in U.S.A.

D S

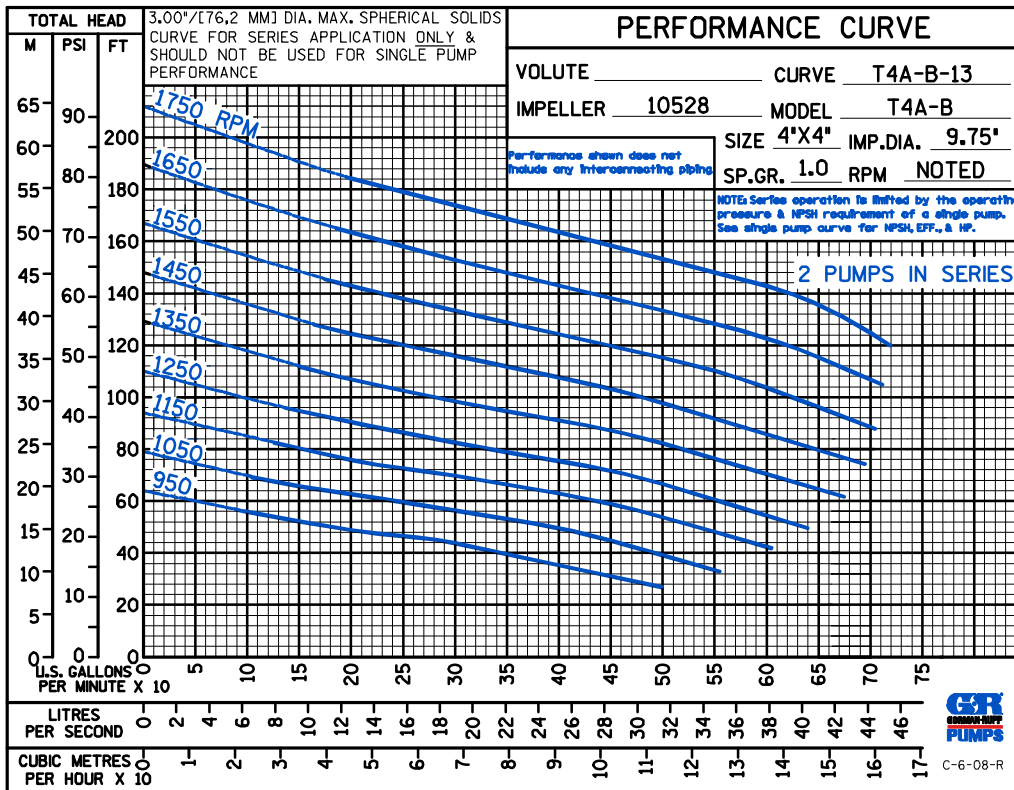
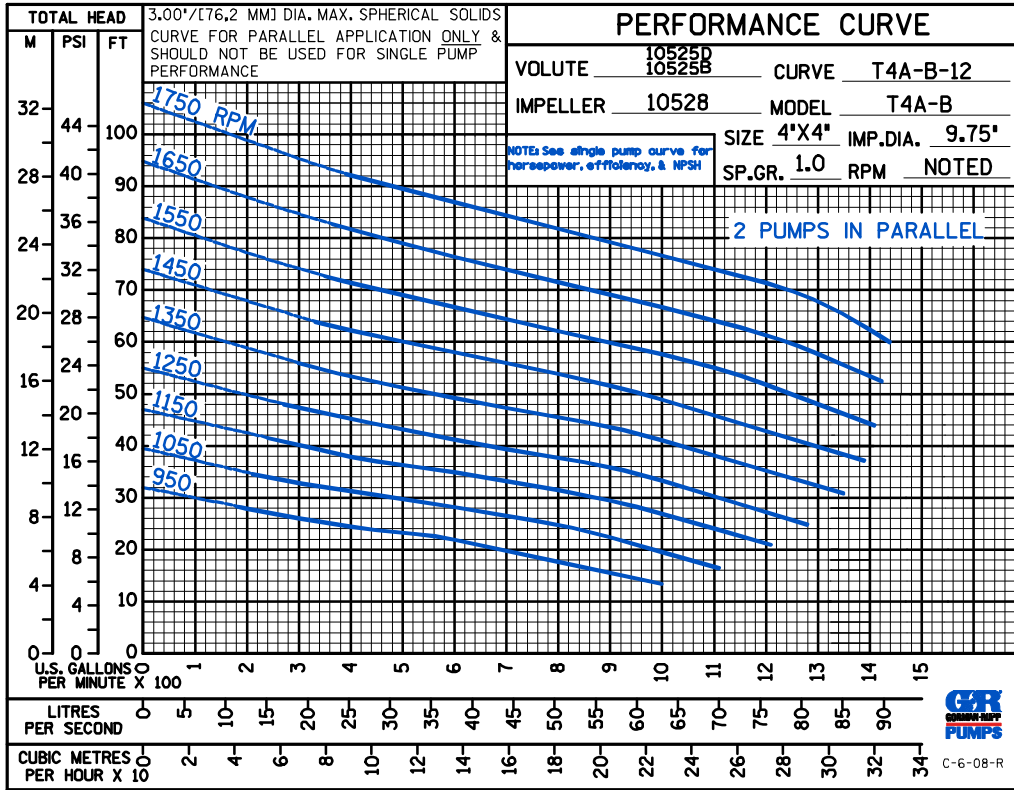

THE GORMAN-RUPP COMPANY • MANSFIELD, OHIO

GORMAN-RUPP OF CANADA LIMITED • ST. THOMAS, ONTARIO, CANADA

Specifications Subject to Change Without Notice

Printed in U.S.A.