

Precision Magnetic Track Following Sensor with Optional Gyroscope

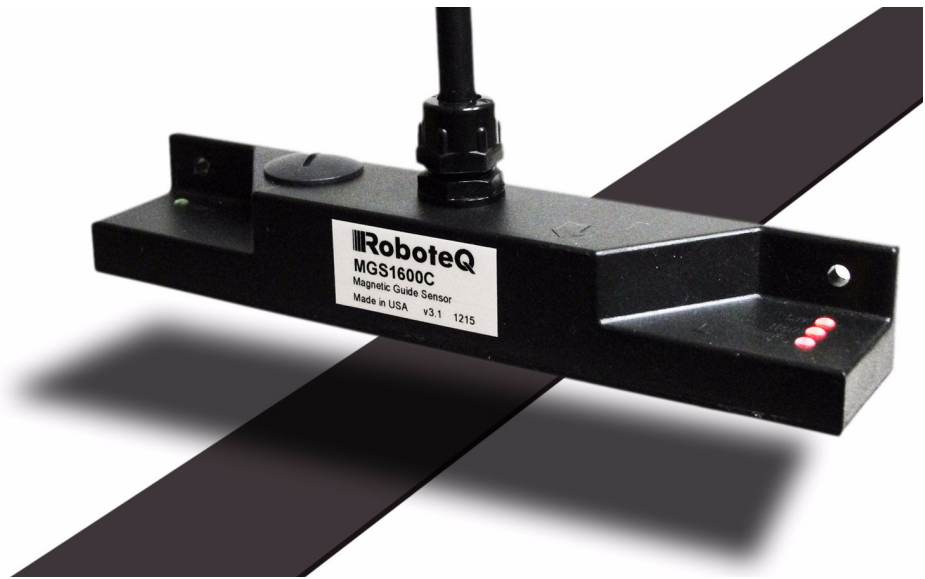

The MGS1600 is a sensor capable of detecting and reporting the position of a magnetic field along its horizontal axis. The sensor is intended for line following robotic applications, using a magnetic tape to form a track guide on the floor.

The sensor uses advanced signal processing to accurately measure its lateral distance from the center of the track, with millimeter resolution, resulting in nearly 160 points end to end. Tape position information can be output in numerical format on the sensor's RS232 or USB ports. The position is also reported as a 0 to 3V voltage output and as a variable PWM output. Additionally, the sensor supports a dedicated MultiPWM mode allowing seamless communication with all Roboteq motor controllers using only one wire.

The sensor will detect and manage up to 2-way forks and can be instructed to follow the left or right track using commands issued via the serial/USB ports, or using the state of two digital inputs. All of the sensor's operating parameters and commands are also accessible via its CAN bus interface.

In addition to detecting a track to follow, the sensor will detect and report the presence of magnetic markers that may be positioned on the left or right side of the track. The sensor is equipped with four LEDs for easy monitoring and diagnostics.

The MGS1600 is available with an optional 3-axis Gyroscope that can be used to provide additional stability and guidance to the vehicle.

The sensor incorporates a high performance, Basic-like scripting language that allows users to add customized functionality to the sensor. A PC utility is provided for configuring the sensor, capture and plot the sensor data on a strip chart recorder, and visualize in real time the magnetic field as it is seen by the sensor.

The sensor firmware can be updated in the field to take advantage of new features as they become available.

Applications

- Automatic Guided Vehicles
- Automated warehouses
- Automated shelves restocking system
- Material conveying robots
- Flexible assembly lines

Key Features

- Detects and measures position of magnetic track along horizontal axis
- Optimized for use with 25mm or 50mm wide adhesive magnetic tape
- 10mm to 60mm operating height
- 160mm sensing width with 1mm resolution
- Selectable, North or South on top, magnetic polarity of track
- Up to 2-way fork/merge detection and management
- Detection of magnetic "markers" of inverted polarity at left or right of main track
- 3 Axis MEMS Gyroscope with selectable range and better than 14-bit resolution
- Simple interface to most PLC brands and to micro-computers
- Direct and seamless interface to Roboteq motor controllers
- 100Hz update rate
- Status LEDs for tape and marker detection
- Digital inputs for "follow left, or right" command at forks
- Digital outputs for "tape present" and left/right marker detect
- Numerical Tape position data output on RS232 or USB ports

- Tape position on PWM output at 250Hz or 500Hz
- Tape position on 0-3V analog output
- CAN interface up to 1Mbit/s
- Built-in programming language for optional local processing of tape and marker data
- Easy configuration, testing and monitoring using provided PC utility
- Field upgradable software for installing latest features via the internet
- Delivered with 2 meters muticonductor cable for all connections
- Wide range 4.5V to 30V DC operation
- 165 mm wide x 30 mm deep x 25 mm tall
- -40o to +85o C operating environment
- IP64 rated enclosure. Resistant to water splash

Orderable Product References

Reference	Description
MGS1600	160 mm wide magnetic tape sensor with serial, USB, analog, PWM and CAN output
MGS1600GY	Magnetic guide sensor with 3-axis Gyroscope, serial, USB, analog, PWM and CAN output
MTAPE25NR	25 mm wide magnetic tape for MGS1600 with North top side. 50m (150ft) roll
MTAPE50NR	50 mm wide magnetic tape for MGS1600 with North top side. 50m (150ft) roll

Benefits of Magnetic Line Tracking

Because they are totally passive, magnetic tracks are easy to lay and modify. They are dirt immune and can be made totally invisible under carpet, tile or other flooring cover. The table below lists the differences between the three major line following technologies used in the industry today.

TABLE 1.

	Magnetic	Optical	Induction
Track type	Passive	Passive	Active (1)
Track shape	Flat tape	Flat trace	Wire
Track laying	Easy	Easy	Difficult (2)
Laying forks & merges	Easy	Easy	Difficult (2)
Dirt immune	Yes	No	Yes
Sensible to light conditions	No	Yes	No
Invisible track	Yes (3)	No	Yes
Markers	Yes (4)	No	No

Note 1: Requires high frequency current to flow in wire.
 Note 2: Forks & merges must not disrupt current flow.
 Note 3: Magnetic tape may be hidden under carpet or other non ferrous floor covering.
 Note 4: Markers use tape of inverted magnetic polarity and therefore very distinctive to the sensor.

Magnetic Tape Selection & Installation

The sensor is factory calibrated for use with 25mm or 50mm wide tape from Roboteq, but may be used with tape from other suppliers as well. Only unipolar tape must be used, where one side is all of one magnetic polarity and the other of the other polarity. In the default configuration, the sensor expect South on the top side for the track and North on the top side for markers. The sensor can be configured to operate with tape of inverted polarity. The sensor will not work with tape of alternating polarity. To determine the tape orientation, point compass towards the top (non adhesive) side of the tape. The north pointing needle will be attracted to the south side of the tape, and the south pointing needle will be attracted to the north side of the tape.

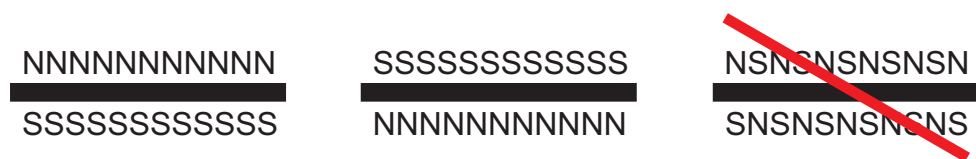

FIGURE 1. Magnetic tape

Operating height is up to 50mm when used with 25mm wide tape and 60mm when used with 50mm wide tape. At higher heights, the magnetic field of the tape is weaker and the sensor will be less immune to noise. For best results, operate at 20 to 30mm with 25mm tape and 20 to 40mm with 50mm tape.

Sensor Installation

The sensor must be mounted so that it is parallel with the floor and the magnetic track. Two mounting holes are provided at both ends of the enclosure. When installing, allow room for accessing the USB connector under the plug.

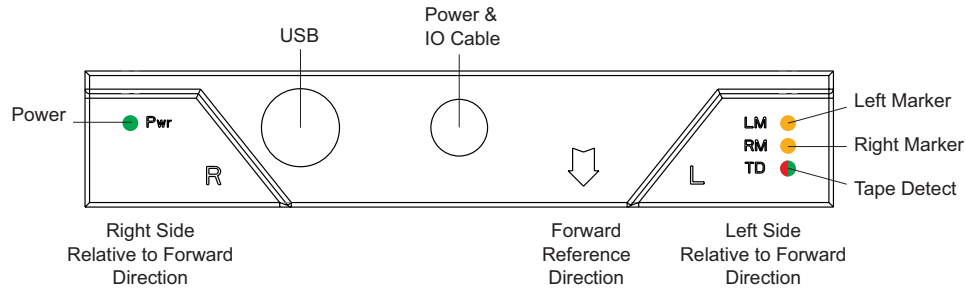

FIGURE 2. Sensor outline

I/O and Power Cable

The MGS1600 comes with a 15-pin DSub connector at the end of 2.0 meter multiconductor cables for powering the sensor and accessing all the I/O signals. The connector can be cut off and the connections done directly on the wires. The connector pins and wire colors are identified in the table below.

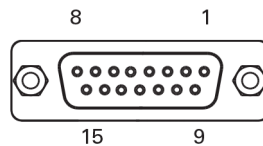

FIGURE 3. Connector pin locations

TABLE 2.

Wire color	Signal	Type	DSub pin	Description	
	braid	Ground	Power	5	Ground
	black	Ground	Power	5	Ground
	red	Power In	Power	14	4.5V to 30V DC Power supply input
	yellow + black	Power Control	Input	10	Power down
	light green + black	CANL	I/O	6	CAN Low
	red + black	CANH	I/O	7	CAN High
	purple	Fork Right	Input	8	Select right track
	pink	Fork Left	Input	1	Select left track
	yellow	Analog Out	Output	4	0-3V (1.5V center) Analog track position
	blue	PWM Out	Output	15	Track position PWM output
	brown	Left Marker	Output	9	Left marker detected
	orange	Right Marker	Output	11	Right marker detected
	green	Track Present	Output	13	Track detected
	grey	RxDData	Input	3	RS232 receive data
	white	TxDData	Output	2	RS232 transmit data
	white + black	Reserved	N/A	12	Do not connect

Powering the sensor

Apply a 4.5V to 30V Max voltage between the ground wire (black) or braid, and the power input wire (red). Beware not to confuse the solid red power wire with the red/black wire. If needed, the sensor can be powered down by connecting the Power Down wire (yellow & black) to ground, or applying a logic 0 signal. If the Power Down wire

is floating, or pulled above 1.5V, the sensor will turn on. The sensor will also be powered if it is connected to a PC via the USB connector. The Power Down wire will not turn off the sensor if powered from the USB.

Important Warning

Only ground or float to the Power Down signal. Never apply a voltage higher than 5V to this wire. Product damage can occur.

RS232 Connection

Serial communication with the sensor is done using the RxData (grey) and RxData (white) signals. The ground wire (black or braid) must be connected in order to provide a reference to the RxData and TxData signal. Serial communication will not work with microcomputers equipped with TTL-levels serial ports.

PWM Output

The PWM Output wire (blue) is always active. In default configuration, multiple pulsed of variable width are used to carry all sensor information, including tape detect and marker position to Roboteq motor controllers. The output can also be configured to carry the tape position by varying the duty cycle of a single, continuous pulse from 50%, when the tape is centered, to 25% and 75% duty cycle when the tape is at one end or the other of the sensor. The PWM output is centered at 50% when no tape is detected.

Analog Output

The Analog Output wire (yellow) is always active and will give the tape position by varying the voltage from 1.50V, when the tape is centered, to 1.20 and 1.80V when the tape is at one end or the other of the sensor. The Analog output is centered at 1.50V when no tape is detected.

Track Present Outputs

The Track Present wire will output a 5V level when a magnetic tape is within the sensor's range. If no tape is detected, the output will be set to 0V.

Left and Right Markers Outputs

The Left Marker wire (brown) and Right Marker wire (orange) will output a 5V level when a left or right marker is detected by the sensor. If no marker is detected, the output will be set to 0V. These output mirror the state of the left and right marker detect LEDs.

Fork Left and Fork Right Inputs

The Fork Left wire (pink) and Fork Right wire (purple) are used to select which of the Left or Right tape capture must be output on the PWM and Analog wires.

CAN Low and CAN High

The CAN Low wire (light green and black) and CAN High wire (red and black) are used to connect the sensor to a CAN network. Do not confuse the solid red wire (Power supply) with the red/black wire (CAN High). The sensor does not include a 120 ohm termination resistor.

Serial Port Settings

The baud rate and communication settings on the sensor are set as follows:

- 115200 bits/s
- 8-bit data
- No parity
- No flow control

The baud rate can be changed to different values but only while the controller is connected to the configuration PC utility via USB. Beware that once the baud rate is changed, it will no longer be possible to have the PC utility communicate with the sensor via the serial port until the speed is changed back to 115200 bit/s.

Track information

The presence and position of a magnetic track is output on the I/O connector, and/or transmitted via the serial communication port or USB. When the sensor detects the presence of a magnetic track it will activate the Track Present output on the I/O connector. The track position information is also output as a 0-3V analog signal, and a PWM pulse of user definable period and duty cycle range. The track detect and position are reported on the RS232 or USB ports. The position is reported as a signed value, in millimeters, using the center of the sensor as the 0 reference.

Fork and Merge Management

The sensor has an algorithm for detecting and managing up to 2-way forks and merges along the track. Internally, the controller always assumes that 2 tracks are present: a left track and a right track. When following a single track, the sensor considers that the 2 tracks are superimposed. When entering forks, the track widens, so does the distance between the left and right tracks.

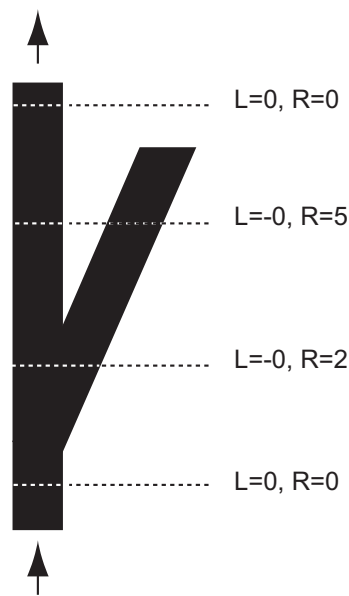

FIGURE 4. Fork management

When approaching merges, the sensor will report a sudden spread of the left and right tracks, but will otherwise operate the same way as at forks.

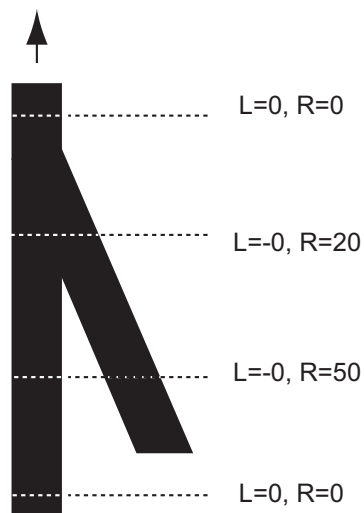

FIGURE 5. Merge management

Both tracks positions can be read via the serial port. Using the state of the Fork Left and Fork Right digital inputs, the sensor will select the left or right track information onto the analog and PWM outputs, according to the selection table below.

TABLE 3.

Fork Left	Fork Right	Analog and PWM Output
Low	Low	No change
High	Low	Left track position
Low	High	Right track position
High	High	Left or right track position depending on command received on RS232/USB

When both inputs are high or unconnected, the selected track will be based on command received via the sensor's serial/USB port, or set using the sensor's scripting language.

Marker Detection

Markers are pieces of magnetic tape that are affixed on the left or/and right side of the main track. To differentiate them from the track, markers have opposite magnetic polarity. These markers can be used to inform the robot of special areas along the track, such as forks or merges ahead, high or low speed zones, charge stations, etc. Markers must be positioned 15 to 30mm away from the edge of the main track for proper operation.

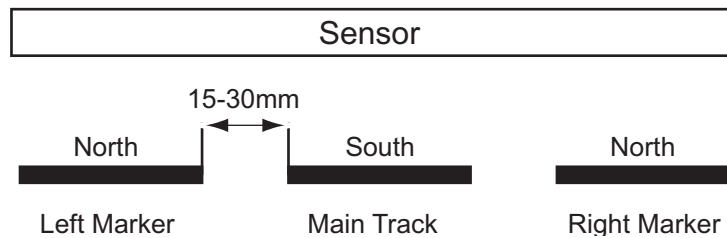

FIGURE 6. Direction markers

The figure below shows example of a simple marker (i.e. marker present or absent) and 2 dimensional markers where a pattern is used to encode more complex information. In this example, using the built in scripting language, the sensor can be made to count the number of right markers while a left marker is present.

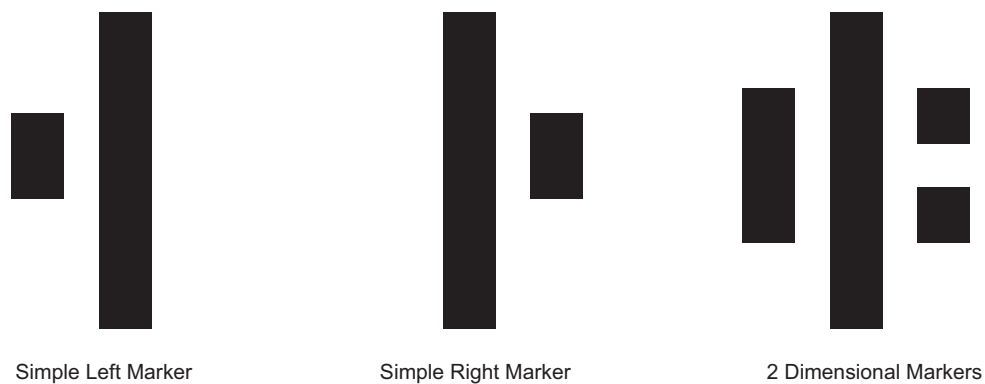

FIGURE 7. Markers usage examples

Absolute with Markers Detection Mode

The sensor has two modes of operation. In Absolute mode, the field is measured relative to a reference ambient 0 level. A little above this level, the signal will be considered as being from the Track. At 3 user selectable sensitivity levels below the zero line, the signal will be considered as a Marker.

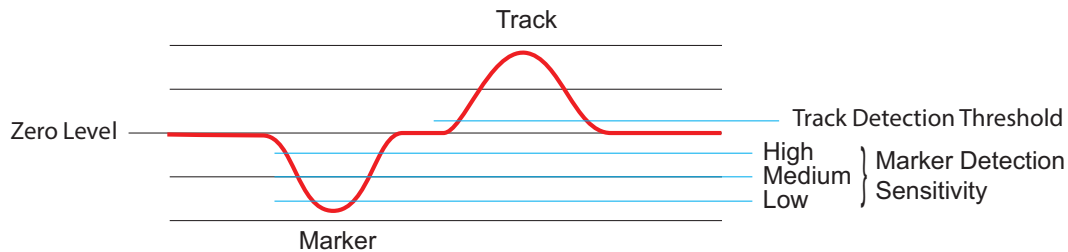

Figure 8 Detection levels in Absolute mode

This mode is therefore dependent on the ambient magnetic field to be quite stable throughout the path of the AGV, and that the zero level be calibrated. After calibration if no track or marker is present, the level should hover around the 0 level. It is recommended to survey the site with the sensor around 25mm all around the projected path to verify that there are no local disturbance by metal part in the floor.

If the zero level is higher in some areas, it may cross the Track detection threshold and detect a track where there is none. This can be corrected by adding a correction that has the effect of shifting the entire field capture up or down. Use the ZADJ configuration command to make this correction (see configuration commands table).

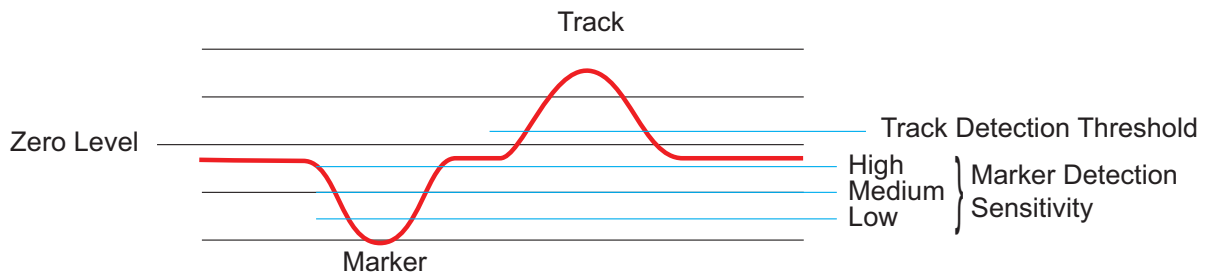

Figure 9: Absolute capture shifted using ZADJ configuration command

Beware that if the sensor capture is shifted too low, this could then trigger false Marker detections. This can be alleviated by selecting a lower marker sensitivity level.

Relative without Markers Mode

In the Relative mode, the sensor evaluates the shape of the curve independently of its position relative the the 0 level. It then sets the detection level to around the middle of the curve.

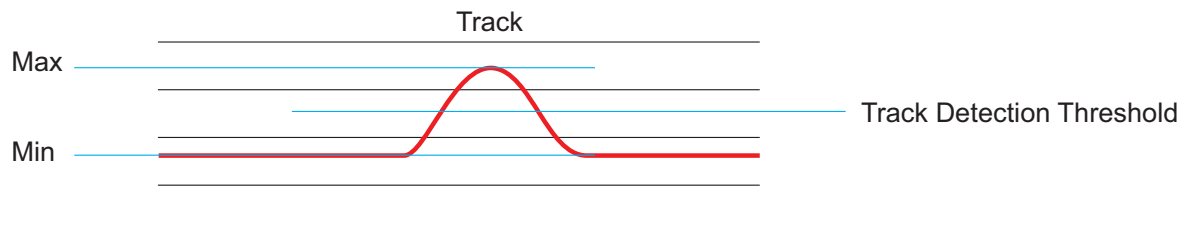

Figure 10: Relative capture is independent of the ambient 0 level

This technique is therefore a lot less sensitive to variations to the ambient level. However, it does not permit the use of Markers.

Gyroscope (optional)

The sensor may be ordered with a built-in 3-axis MEMs Gyroscope (MGS1600GY version). The Gyroscope provides an accurate measurement of the rate of rotation along each of the sensors planes with 3 levels of resolution: +/-250 degrees/s, +/-500 degrees/s and +/-2000 degrees/s. The Gyroscope can be used to provide added stability to the AGV. It can also be used to make the AGV continue to move in a straight line, without guiding tape, between two magnetic tapes or magnetic pins.

The Gyroscope values can be read via USB, Serial or CANbus. The Z sensor value is also automatically transmitted to a Roboteq motor controller, along with the magnetic sensor data, using a single wire and the MultiPWM mode.

The Gyroscope values are integers with the following range:

TABLE 4.

Resolution	Value Range	Divider
+/-250	+/-25000	100
+/-500	+/-5000	10
+/-2000	+/-20000	10

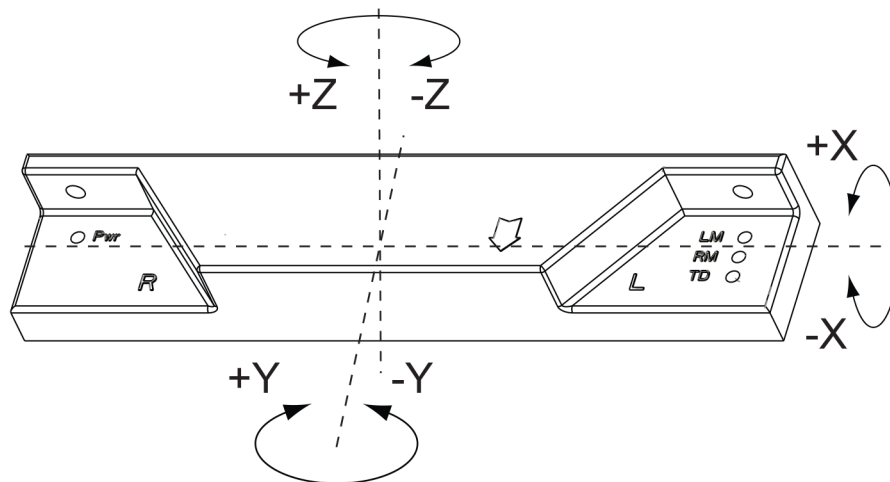

FIGURE 11. Orientation of the Gyroscope axis

Diagnostic LEDs

Since magnetic fields are invisible, the sensor is equipped with four LEDs to help setup and troubleshooting. The LED positions are shown in Figure 2. The Power LED will lit when the sensor is on. The Track Detect/Track Position LED is a dual usage LED that will lit when a track is present. The LED is bicolor and will gradually shift to red when the track is at the left of the sensor, and to green as the track moves to the right. Two additional LEDs will turn on when left or right markers are detected.

Interfacing the Sensor to PLCs

The sensor can be fully interfaced to a PLC with only 3 wires as shown in the figure below. Prefer the PWM method to analog as it is more accurate and noise immune.

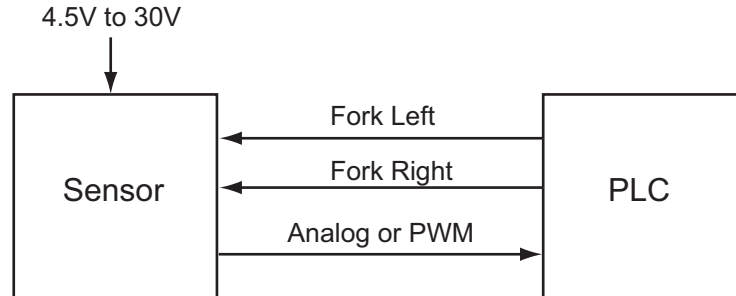

FIGURE 12. PLC interfacing

Interfacing the Sensor to Roboteq Motor Controllers

The MGS1600 will interface directly and seamlessly to all Roboteq models of controllers for brushed and brushless DC motors. The sensor can be powered from the controller's 5V output. The left, right, tape detect and marker information is sent from the sensor using the PWM Output configured as "Roboteq MultiPWM". The signal must be connected to any of the controller's Pulse Inputs configured with the PC utility as "Mag-sensor". The data is sent continuously with a 10ms update rate. Roboteq provides script examples that run in the motor controller for implementing basic line following AGV functionality.

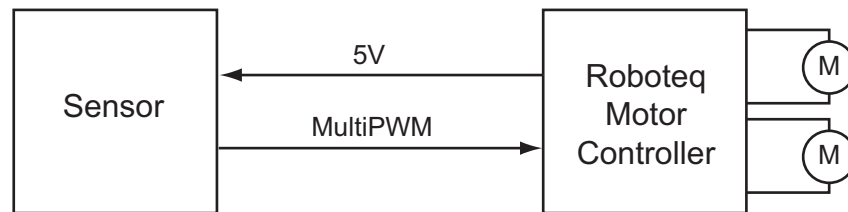

FIGURE 13. Roboteq motor controllers interfacing

Interfacing the Sensor to PCs or Microcomputers

Interfacing the sensor to a PC requires a simple USB connection. The sensor will be powered via the 5V present on the USB.

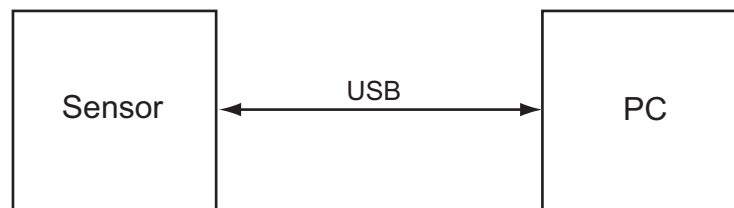

FIGURE 14. PC interfacing

If no USB is available, interfacing can be done using the PC or Microcomputer RS232 port and a separate 4.5V to 30V power supply.

Using the PC Utility

A powerful utility is available for download from Roboteq's web site for setting up, monitoring and performing maintenance functions. While the sensor is delivered ready to use right off the box, it contains many parameters that can easily be changed using user-friendly menus. For testing and troubleshooting, the utility includes a graph that plots in real time the shape and strength of the magnetic field as it is seen by the sensor. A strip chart recorder allows the user to plot the track and marker information, and save the data in an excel spreadsheet for analysis. The utility is also used for performing field updates of the sensor firmware and for editing and running scripts.

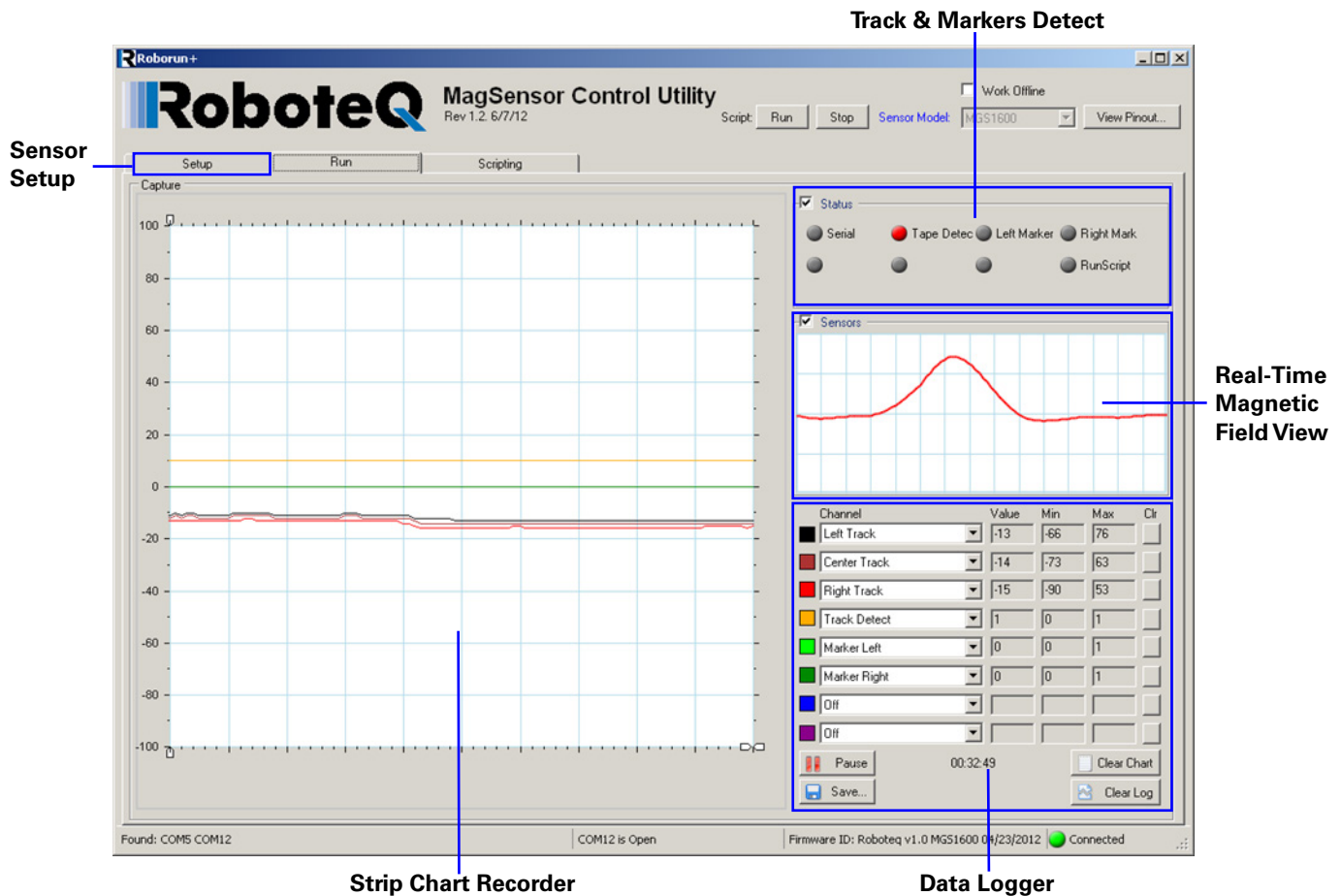

FIGURE 15. MagSensor Control Utility

MicroBasic Scripting

The MGS1600 features the ability for the user to write programs that are permanently saved into, and run from the sensor's Flash Memory. This capability is the equivalent of combining the functionality of a PLC or Single Board Computer directly into the sensor. The language is a very simple, yet powerful language that resembles Basic. Scripts can be simple or elaborate, and can be used for various purposes. For example sensor data manipulation and conversion, 2 dimension marker processing, or even the full motion and steering control for a simple line following robot. See the Microbasic manual for details on the language.

Sensor Calibration

The sensor is factory calibrated for 25mm and 50mm wide magnetic tapes available from Roboteq. If tapes of different width or magnetic strength are used, the sensor can be recalibrated by the user. The sensor is also factory calibrated to compensate for the natural ambient magnetic field. For best results, the ambient “zero” must be reset in every new installation. This is done by clicking on the “Calibrate Zero” button on the Setup tab of the PC utility. Make sure that the sensor is away from any magnetic material when doing the zero calibration.

Command Reference Summary

The sensor accepts a number of commands via its RS232 and USB ports for reading operational data, sending commands, setting configuration, and performing maintenance.

Real Time Queries

These are commands for reading sensor data. They begin with the question mark character. Table 5 shows the list of supported queries.

Each time a query is executed, it is stored in a history buffer and may therefore be automatically repeated at a periodic rate using the # character with the following syntax:

- # repeat last query in queue
- # nn repeat last queries ever nn ms. Example: # 100 to execute one query from the history queue every 100ms
- # C clear queue

TABLE 5.

Command	Arguments	Description	Examples
B	Index Value	Read User Boolean Variable	?B 1
MGD	None	Read Track Detect	?MGD
MGM	[MarkerNumber]	Read all markers, or one of the 2	?MGM, ?MGM 2
MZ	[SensorNumber]	Read all internal sensor values, or one of the 16	?MZ, ?MZ 16
T	None	Read selected track	?T
MGT	[TrackNumber]	Read both the left and right tracks, or one of the 2	?MGT, ?MGT 2
VAR	Index Value	Read User Integer Variable	?VAR 5
GY	[Axis]	Read Gyroscope	?GY, ?GY 2

Real Time Commands

These are commands used to instruct the sensor to do something. They begin with the exclamation mark character. Table 6 shows the list of supported commands.

TABLE 6.

Command	Arguments	Description	Example
B	Index Value	Set User Boolean Variable	!B 1 1
R	option	Run/Stop/Resume MicroBasic scripts	!R = Run/Resume, !R 0 = Stop, !R 2 = Restart
TV	none	Follow Right track	!TV
VAR	Index Value	Set User Integer Variable	!VAR 5 12345
TX	none	Follow Left track	!TX

Configuration Commands

These commands are used to read or modify sensor configuration parameters. They begin with the ~ character for reading and the ^ character for writing. Table 7 shows the list of supported configuration commands. However, it is easier and preferable to use the PC utility menus for inspecting and changing configurations. If changing manually, remember to save the new configuration to flash with the %EESAV. Otherwise, the sensor will revert to the previously active configuration next time it is powered on.

TABLE 7.

Command	Arguments	Range	Default	Description
BRUN	Value	0 = disable, 1 = enable	0	Auto start MicroBasic script at power up
GRNG	Value	0= 250 dps, 1= 500 dps, 2= 2000 dps	0	Select Gyroscope Range
PWMM	Value	0 = Roboteq MultiPWM, 1= 250Hz, 2= 500Hz MMOD Value 0=Absolute w/markers, 1= Relative w/o markers 0 Tape detection mode BADJ Value +/-100 0 Correction to Left/Right tape reading	0	PWM Output mode
RSBR(1)	Mode	0 = 115.2K 1= 57.6K 2 = 38.4K 3 = 19.2K 4 = 9600	0	Set serial port bit rate
SCRO	ScriptOutput	0 = last port used, 1 = RS232, 2 = USB	0	Output port for MicroBasic print commands
TINV	Value	0 = Left - to Right +, 1= Left + to Right -	0	Change sign of position values
TMS	Value	0= High, 1= Med, 2= Low	0	Select Marker Sensitivity
TPOL	Value	0 = South top, 1= North top	0	Select magnetic tape width
TWDT	Value	0 = 25mm, 1= 50mm	0	Select magnetic tape polarity
TXOF	Value	-100 to +100	0	Offset added/subtract to track position values
ZADJ	Ch Value	+/- 1000	0	Zero Level User Offset for each of the 16 internal sensors. Send ^ZADJ 0 nn to change all sensors at once.
Note 1: Serial port bit rate can only be changed while the sensor is connected to the PC via USB				

Maintenance Commands

These commands are used to perform maintenance functions on the sensor. They begin with the % character. Table 8 shows the list of supported configuration commands.

TABLE 8.

Command	Arguments	Description
CLSAV	None	Save calibration to EEPROM
CLRST	Key (1)	Load factory default calibration
EELD	None	Load configuration from EEPROM
EERST	Key (1)	Load factory default configuration
EESAV	None	Save configuration to EEPROM
GZER	None	Set zero calibration for Gyroscope
ZERO	None	Set zero calibration level for magnetic sensors

Note 1: To prevent accidental entry, the command must be followed by the key 32164987

CANbus Communication

The sensor supports 4 different CAN protocols

RoboCAN: a simple meshed networking scheme to exchanging commands and queries with any other Roboteq motor controller or sensor.

RawCAN: a low level scheme that allows to build and parse CAN frames using the MicroBasic scripting language

MiniCAN: a scheme that borrow's CANOpen's TPDO and RPDO mechanisms for sending and capturing frames with fixed content.

CANOpen: an industry standard ensuring interoperability with other vendor's PLCs and devices

Details on these protocols can be found in the separate CAN Communication manual.

The structure and content of the TPDO and RPDO frames is the same in both MiniCAN and CANOpen and is shown in the table below.

Header: TPD01: 0x180 + NodeID

TPD02: 0x280 + NodeID

Data:

	Byte1	Byte2	Byte3	Byte4	Byte5	Byte6	Byte7	Byte8
TPD01	Left Track	Right Track	Flags					
TPD02	VAR 1					VAR 2		

Where Flags are:

Bit1	Bit2	Bit3	Bit4	Bit5	Bit6	Bit7	Bit8
					Right Marker	Left Marker	Tape Detect

Header: RPD01: 0x200 + NodeID

RPD02: 0x300 + NodeID

Data:

	Byte1	Byte2	Byte3	Byte4	Byte5	Byte6	Byte7	Byte8
RPD01	VAR 2				VAR 3			
RPD02	VAR 4				VAR 5			

In CAN Open the sensors Realtime Commands and Queries are mapped as shown in the Object Dictionary below. Configuration commands are not directly accessible via CANOpen.

TABLE 9.

Index	Sub (Hex)	Entry Name	Data Type & Access	Command Name
Runtime Commands				
0x2005	01 to 10	Set User Integer Variable n	S32 WO	VAR
0x2015	01 to 32	Set User Bool Variable n	S32 WO	B
0x2017	00	Save Config to Flash	U8 WO	EESAV
0x2018	00	MicroBasic Run	U8 WO	BRUN
0x201A	00	Follow Left track	U8 WO	TX
0x201B	00	Follow Right track	U8 WO	TV

TABLE 10.

Index	Sub (Hex)	Entry Name	Data Type & Access	Command Name
Runtime Queries				
0x2106	1 to 10	Read User Integer Variable n	S32 RO	VAR
0x210F	00	Read Dominant Track	S8 RO	T
0x2115	01-20	Read User Bool Variable n	S32 RO	B
0x211D	00	Read Track Detect	U16 RW	MGD
0x211E	01	Read Left Track	U8 RW	MGT
	02	Read Right Track		
	03	Read Selected Track		
0x211F	01	Read Left Marker	U8 RW	MGM
	02	Read Right Marker		
0x2120	00	Read Status	U8 RW	MGS
0x212D	01 -10	Read Raw Sensor N	U32 RO	MRS
0x212E	01 -10	Read Zero Adjusted Raw Sensor n	S32 RO	MZ
0x2131	01	Read Gyro X	S16 RO	GY
	02	Read Gyro Y		
	03	Read Gyro Z		

Sensor Characteristics

TABLE 11.

Parameter	Min	Typ	Max	Units
Capture width		160		mm
Resolution	1	1	2	mm
Operating height with 25mm track	10	30	50 (1)	mm
Operating height with 50mm track	20	30	60 (1)	mm
Update rate		100		Hz

Note 1: Ambient magnetic fields may impair sensor data at highest height. Higher height can be reached with doubled tape, or by using stronger magnetic material.

Electrical Characteristics

Absolute Maximum Values

The values in the table below should never be exceeded. Permanent damage to the controller may result.

TABLE 12.

Parameter	Measure point	Min	Typ	Max	Units
Power Supply Input Voltage	Ground to Red wire	-1		35	Volts
Digital Input Voltage	Fork Left and Right inputs	-1		15	Volts
Digital Output Current	Digital and PWM outputs sink			20	mA
Analog Output Current	Analog Output			10	mA
CAN Input Voltage	Ground to CAN-H and CAN-L pins			40	Volts
RS232 I/O pins Voltage	External voltage applied to Rx/Tx pins			25	Volts

Power Stage Electrical Specifications (at 25°C ambient)

TABLE 13.

Parameter	Measure point	Min	Typ	Max	Units
Input Voltage on 5V inputs	Ground to Red wire	4.5		30	Volts
Power consumption	Power supply input	120 (1)		20 (1)	mA

Note 1: Consumption is lower as the power supply voltage is higher.

Command, I/O and Sensor Signals Specifications

TABLE 14.

Parameter	Measure point	Min	Typ	Max	Units
Digital Output Current	Output pins, sink/source current			20	mA
Digital Input 0 Level	Ground to Input pins	-1		1	Volts
Digital Input 1 Level	Ground to Input pins	3		15	Volts
Analog Output Range	Ground to Output pin	0		3	Volts

TABLE 15.

Parameter	Measure point	Min	Typ	Max	Units
Analog Output Current	Ground to Output pin			10	mA
PWM Frequency	PWM Output	250 (1)		500 (1)	Hz
PWM Duty Cycle	PWM Output	25		75	%
Note 1: 250 or 500Hz user selectable					

Gyroscope Specifications

TABLE 16.

Parameter	Min	Typ	Max	Units
Gyro Slow Rate			250	degrees/s
Gyro Med Rate			500	degrees/s
Gyro Fast Rate			2000	degrees/s
Resolution	13	14(1)	15	bits
Update Rate		100		Hz
Note 1: Gyroscope is read in 16 bit. Least significant bit can be noisy and not meaningful				

Scripting

TABLE 17.

Parameter	Measure Point	Min	Typ	Max	Units
Scripting Flash Memory	Internal		2048		Bytes
Max Basic Language programs	Internal		500	750	Lines
Integer Variables	Internal			1024	Words (1)
Boolean Variables	Internal			1024	Symbols
Execution Speed	Internal		50 000		Lines/s
Note 1: 32-bit words					

Environmental & Mechanical Specifications

TABLE 18.

Parameter	Measure Point	Min	Typ	Max	Units
Operating Temperature	Sensor	-20		85	oC
Weight	Sensor		100 (1)		g (lbs)
Protection	Case		IP64		
Cable Diameter	Cable		7.0		mm
Cable Length	Cable		2.0		m
Note 1: Excluding cable					

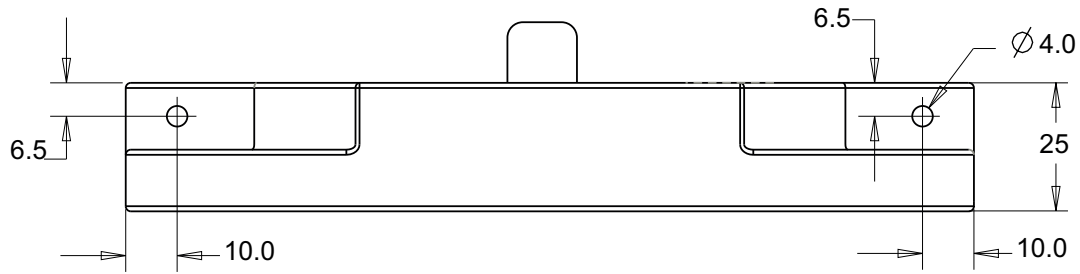

FIGURE 16. MGS1600 front view and dimensions

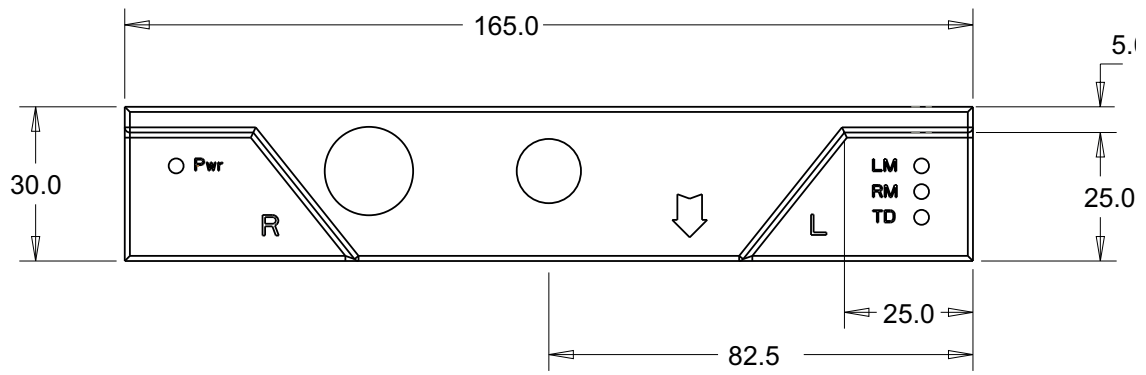

FIGURE 17. MGS1600 top view and dimensions